



Genesys

Migration Guide

The information contained herein is proprietary and confidential and cannot be disclosed or duplicated without the prior written consent of Genesys Telecommunications Laboratories, Inc.

Copyright © 2000–2009 Genesys Telecommunications Laboratories, Inc. All rights reserved.

About Genesys

Genesys Telecommunications Laboratories, Inc., a subsidiary of Alcatel-Lucent, is 100% focused on software for call centers. Genesys recognizes that better interactions drive better business and build company reputations. Customer service solutions from Genesys deliver on this promise for Global 2000 enterprises, government organizations, and telecommunications service providers across 80 countries, directing more than 100 million customer interactions every day. Sophisticated routing and reporting across voice, e-mail, and Web channels ensure that customers are quickly connected to the best available resource—the first time. Genesys offers solutions for customer service, help desks, order desks, collections, outbound telesales and service, and workforce management. Visit www.genesyslab.com for more information.

Each product has its own documentation for online viewing at the Genesys Technical Support website or on the Documentation Library DVD, which is available from Genesys upon request. For more information, contact your sales representative.

Notice

Although reasonable effort is made to ensure that the information in this document is complete and accurate at the time of release, Genesys Telecommunications Laboratories, Inc., cannot assume responsibility for any existing errors. Changes and/or corrections to the information contained in this document may be incorporated in future versions.

Your Responsibility for Your System's Security

You are responsible for the security of your system. Product administration to prevent unauthorized use is your responsibility. Your system administrator should read all documents provided with this product to fully understand the features available that reduce your risk of incurring charges for unlicensed use of Genesys products.

Trademarks

Genesys, the Genesys logo, and T-Server are registered trademarks of Genesys Telecommunications Laboratories, Inc. All other trademarks and trade names referred to in this document are the property of other companies. The Crystal monospace font is used by permission of Software Renovation Corporation, www.SoftwareRenovation.com.

Technical Support from VARs

If you have purchased support from a value-added reseller (VAR), please contact the VAR for technical support.

Ordering and Licensing Information

Complete information on ordering and licensing Genesys products can be found in the [Genesys Licensing Guide](#).

Released by

Genesys Telecommunications Laboratories, Inc. <http://www.genesyslab.com>

Document Version: 70g_mg_12-2009_v7.0.020.99



Table of Contents

Preface	27
	Intended Audience.....	28
	Document Conventions	28
	Related Resources	30
	Making Comments on This Document	31
	Contacting Genesys Technical Support.....	31
Part 1	Overview of Migration Process.....	33
Chapter 1	Migration Roadmap	35
	Overview of Migration Process.....	36
	Migration/Upgrade Order.....	36
	Preparations for Migration	37
	Approaches to Migration.....	38
	Solutions/Components and Environment Compatibility.....	39
Chapter 2	Licensing Migration.....	41
	License Control Architecture	41
	License Control Configurations	44
	Upgrading Licensing System.....	47
	Methods for Upgrading Licensing System.....	49
	Upgrading Licensing System with Multiple Vendors	53
Part 2	Framework Migration	57
Chapter 3	Introduction to Framework Migration.....	59
	Preliminary Migration Procedures	59
	Reference Materials.....	60
	Order of Migration for 8.0	61
	Multi-Site/Single-Site and Multi-Tenant Migration	61

	Migration and Upgrade Order	61
	Laboratory Testing and Rollback	62
	Interoperability Among Framework Components	62
	Compatibility Among Framework Components	63
	Additional Information about Migration	67
	About CCW.....	67
Chapter 4	Migration of Configuration Server Proxy 6.5	69
	Preliminary Migration Instructions	69
	Licensing Requirements	70
	Upgrading from 6.5.....	70
	Upgrade Instructions.....	70
	Rollback Instructions.....	71
	Next Steps	71
Chapter 5	Setup of Migration Environment.....	73
	Calculating the New Database Size	73
	Checking Configuration Data.....	73
	Migrating a Changed Database Structure	74
	Installing the Configuration Layer	75
	Installing the Configuration Conversion Wizard.....	76
	Specifying the Database Connection	76
	Configuring the Local Configuration File.....	76
	Entering Connection Parameters Dynamically	79
	Using Password-Encryption	80
Chapter 6	Migration of Configuration Database	81
	About Migration from Previous Releases	81
	Migration Instructions	82
	Starting Applications for Conversion.....	82
	Converting Configuration Data	83
	Starting the 8.0 Environment	86
	Resolving Data Inconsistency.....	87
Chapter 7	Changes in Framework.....	89
	Component Changes for Framework	89
	Configuration Option Changes for Framework.....	99
	General Configuration Option Changes.....	99
	DB Server	103
	Database Access Point.....	105
	Configuration Server	105

	Configuration Manager	110
	Local Control Agent	111
	Message Server.....	111
	Solution Control Server.....	112
	Solution Control Interface	113
	Genesys SNMP Master Agent.....	113
Chapter 8	Upgrade of Framework Components	115
	Upgrade Overview.....	115
	Migrating Framework Components to 8.0	116
	Migration Procedures.....	117
Chapter 9	Migration of SNMP Option	125
	Preliminary Migration Instructions	125
	Licensing Requirements	126
	Migrating from 5.1.....	126
	SNMP Option Upgrade Instructions.....	126
	SNMP Option Rollback Instructions.....	127
	Upgrading from 6.0 or 6.1.....	127
	SNMP Option Upgrade Instructions.....	127
	SNMP Option Rollback Instructions.....	128
	Upgrading from 6.5.....	128
	SNMP Option Upgrade Instructions.....	128
	SNMP Option Rollback Instructions.....	129
Chapter 10	Load Distribution Server Migration	131
	Changes in LDS Release 7.0	131
	Changes in LDS Release 7.1	133
	Changes in LDS Release 7.2	133
	Prerequisites for Migration from LDS 6.5 or 7.0 to 7.x	134
	Installing LDS	134
	Configuration Option Changes from 6.5 to 7.2.....	136
Chapter 11	Stat Server Migration	141
	Preliminary Migration Instructions	141
	Licensing Requirements	141
	Compatibility with Framework Components	142
	Stat Server 8.x General Changes.....	142
	Stat Server 7.x General Changes.....	143

	Configuration Option Changes	147
	Migrating to 8.x	156
	Upgrading Stat Server	156
	Updating an Existing Stat Server Database	156
	Implementing Other Configuration Updates	156
	Rolling Back Stat Server	157
Chapter 12	Integration Server and Software Development Kits Migration.....	159
	Overview.....	160
	Genesys Integration Server with Custom Clients	161
	System Requirements for 7.2 (or later)	162
	System Requirements for 7.1	162
	System Requirements for 7.0	163
	GIS Migration 7.5 to 7.6.....	163
	GIS Migration 7.2 to 7.5 (or later)	163
	GIS Migration 7.0 or 7.1 to 7.2 (or later).....	164
	GIS Migration 6.5.1 to 7.x.....	165
	GIS Migration 6.1 or 6.5.0 to 7.x.....	166
	Start and Test GIS	166
	Update Your Client Application	166
	Changes to GIS Application Options	166
	Options Tab Option Changes.....	167
	Changes to Error Messages 6.5.1 to 7.x.....	168
	6.1 and 6.5.0 to 7.x Statistics API.....	171
	Changes to Statistics API Methods from 6.1 and 6.5.0 to 7.x	172
	Changes to Statistics API Types.....	174
	6.5.1 to 7.x Configuration API.....	177
	New Configuration Server SOAP Interface.....	177
	Unregister Operation	178
	Unsolicited Notification	178
Part 3	Reporting Migration	179
Chapter 13	Introduction to Reporting Migration	181
	Preliminary Migration Procedures	181
	Reference Materials.....	182
	Migration Considerations.....	182
	Implementation Considerations	183
	Architectural Differences.....	184
	Configuration and Installation Issues.....	186
	Template Issues.....	188

	Report Issues.....	191
	Framework Issues	191
	Interoperability Among Framework and Reporting Components.....	192
Chapter 14	Changes in Reporting 7.x	193
	Changes in Release Content.....	193
	Changes to Configuration Options and Runtime Parameters	199
Chapter 15	Reporting Migration Procedures.....	211
	Overview.....	211
	Migrating CC Analyzer 7.x to 7.2.x.....	212
	Migrating CC Analyzer 6.x to 7.x.....	214
	Migrating CC Pulse 6.x/CCPulse+ 7.x to CCPulse+ 7.5.x.....	215
Chapter 16	Reporting Service Pack 6.5	217
	Overview.....	218
	Considerations and Recommendations.....	219
	Data Collection Must Stop	219
	Service Factor Considerations.....	220
	Shared Stat Servers	220
	Stat Type Considerations.....	221
	Canned and Custom Report Layouts	223
	Canned and Custom Brio Report Templates	223
	Recommendations.....	224
	Analyzing Differences in Definitions	224
	Methods of Comparing Stat Type Definitions	225
	Deployment Planning	227
	System Requirements	227
	Genesys Requirements	227
	What Must Be Running.....	228
	What Must Be Stopped.....	228
	Deployment and Removal	228
	Running the Upgrade	229
	Restoring from Backup.....	233
	Stat Type Listing	233
Part 4	Outbound Contact Migration	237
Chapter 17	Introduction to Outbound Contact Migration	239
	Interoperability Among Outbound Contact Components.....	239

	Two Levels of Interoperability	239
	Additional Information About Migration	242
	Preliminary Migration Procedures	242
	Database and Operating System Upgrades	242
	Preliminary Migration Procedures.....	243
	Order of Migration.....	243
	Migration and Upgrade Order	243
Chapter 18	Changes in Outbound Contact.....	247
	Changes in Outbound Contact Components.....	248
	Changes in Configuration Options.....	254
	Other Option Changes	270
	Changes in the Primary Key.....	270
	Changes in Reserved User Data Keys.....	271
	Changes in Fields and Field Values	272
	Changes in Calling Lists and Formats.....	274
	Changes in Licensing	274
Chapter 19	Outbound Contact Migration Procedures	277
	Migration to 8.0.....	277
	Migration Procedure	278
	Migration from 7.5 to 7.6.....	280
	Migration Procedure	280
	Migration from 7.2 to 7.5.....	282
	Preliminary Procedures	282
	Migration Procedures.....	283
	Migration from 7.1 to 7.2.....	286
	Preliminary Procedures	286
	Migration Procedures.....	286
	Migration from 7.0 to 7.1.....	290
	Migration from 6.5.2 to 7.2.....	290
	Preliminary Procedures	290
	Migration Procedures.....	290
	Migration from 6.5.100.27-6.5.100.30 to 7.0	292
	Migration from 6.5.xxx-6.5.100.26 to 7.0	295
	Migration from 5.1.5, 6.0, or 6.1	298

Part 5	T-Server Migration	299
Chapter 20	Introduction to T-Server Migration	301
	Preliminary Migration Procedures	301
	Migration Considerations.....	302
	Multi-Site/Single-Site and Multi-Tenant Migration	302
	Redundant T-Servers.....	302
	Historical Changes to T-Server.....	303
	Required Framework Components.....	303
	Earlier Configuration Environment.....	304
	T-Server Enhancements	304
	Interoperability Among Framework Components	305
	T-Server Interoperability	306
	Additional Information about Migration	306
Chapter 21	Changes in T-Server and HA Proxy Configuration Options.....	307
	Configuration Options Common to All T-Servers.....	307
	T-Server-Specific Configuration Options	318
	T-Server for Alcatel A4200/OXO.....	320
	T-Server for Alcatel A4400/OXE	323
	T-Server for Aspect ACD	330
	T-Server for Avaya Communication Manager.....	333
	HA Proxy for Avaya DEFINITY ECS (MV).....	338
	T-Server for Avaya INDeX	338
	T-Server for Avaya TSAPI.....	343
	T-Server for Cisco Unified Communications Manager.....	344
	T-Server for DataVoice Dharma.....	347
	T-Server for Digitro AXS/20	349
	T-Server for Ericsson MD110.....	351
	T-Server for Fujitsu F9600	359
	T-Server for EADS Intecom M6880	361
	T-Server for EADS Telecom M6500 Succession	363
	T-Server for Huawei C&C08	367
	T-Server for Meridian 1	368
	T-Server for Mitel SX-2000/MN-3300	369
	T-Server for NEC NEAX/APEX.....	374
	T-Server for Nortel Communication Server 1000 with SCCS/MLS... ..	376
	T-Server for Nortel Communication Server 2000/2100.....	380
	HA Proxy for Nortel Communication Server 2000/2100	386
	T-Server for Philips Sopho iS3000.....	386
	HA Proxy for Philips Sopho iS3000	388
	T-Server for Rockwell Spectrum	389

	T-Server for Siemens Hicom 300/HiPath 4000 CSTA I.....	391
	T-Server for Siemens HiPath DX.....	397
	T-Server for Siemens HiPath 3000 CSTA III.....	400
	T-Server for Siemens HiPath 4000 CSTA III.....	401
	T-Server for Symposium Call Center Server	406
	T-Server for Tadiran Coral	406
	T-Server for Teltronics 20-20	408
	T-Server for Tenovis Integral 33/55.....	409
	Network T-Server for AT&T.....	411
	Network T-Server for Concert	411
	Network T-Server for CRSP.....	415
	Network T-Server for DTAG.....	416
	Network T-Server for GenSpec.....	417
	Network T-Server for ISCP	425
	Network T-Server for NGSN	426
	Network T-Server for OPSI	427
	Network T-Server for SR3511	427
Chapter 22	T-Server Migration Procedures	429
	Migration from Previous Releases.....	429
	Prerequisites for a 8.0 Framework Environment	429
	T-Server Migration Procedures.....	430
	Known Migration Issues for Specific T-Servers	432
	Deploying T-Server 8.x in 6.x Environment	432
	Licensing Issues for T-Server 8.x in a 6.x Environment.....	432
	HA Environment Migration.....	434
Part 6	Migrating from the IP Media eXchange Solution to the SIP Server Solution	437
Chapter 23	IPMX 7.0.2 Migration to SIP Server 7.2	439
	Overview.....	439
	General Instructions	440
	Required Framework Components.....	440
	Licensing.....	441
	Component Changes from 7.0.2 to 7.2.....	441
	Migration from 7.0.2 to 7.2.....	444
	Migration Procedure	444
	Rollback Instructions.....	453
	Changes From Previous Releases.....	454

Chapter 24	Introduction to IP Media eXchange Migration	461
	General Instructions	461
	Required Framework Components	461
	Licensing.....	462
	Component Changes from 6.5 through 7.0	462
	Other Migration Issues.....	464
	Migration from 6.5 to 7.0.....	464
	General Recommendations	464
	Migration Procedure	464
	Rollback Instructions.....	465
	Changes in Configuration Options.....	466
Part 7	SIP Server Solution Migration.....	475
Chapter 25	Introduction to SIP Server Solution Migration.....	477
	Preliminary Migration Procedures	477
	Migration Considerations.....	478
	Multi-Site/Single-Site and Multi-Tenant Migration	478
	Redundant SIP Servers	479
	Required Framework Components	479
	Earlier Configuration Environment.....	479
	SIP Server Solution Enhancements	480
	Stream Manager Considerations	481
	Interoperability Among Framework Components	482
	SIP Server Interoperability	483
	Additional Information about Migration	483
Chapter 26	SIP Server Solution Migration Procedures	485
	Deploying the SIP Server Solution	485
	Prerequisites for a 7.6 Framework Environment	485
	SIP Server Migration Procedures	486
	Stream Manager Migration Procedures.....	488
	DMX Migration Procedures.....	489
Chapter 27	Changes in Configuration Options	491
	SIP Server Solution-Specific Configuration Options.....	492
	SIP Server	492
	Stream Manager	497
	DMX.....	501
	Network SIP Server	501

Part 8	IVR Interface Option Migration	503
Chapter 28	Introduction to IVR Interface Option Migration	505
	Preliminary Migration Procedures	505
	Reference Materials.....	506
	Component Compatibility	506
	IVR Architecture Changes	507
	IVR Interface Option 8.0 Architecture Enhancements	507
	IVR Interface Option 7.5 Architecture Enhancements	507
	IVR Interface Option 7.2 Architecture Enhancements	507
	IVR Interface Option 7.1 Architecture Enhancements	508
	IVR Interface Option 7.0 Architecture Enhancements	509
	Application Compatibility	509
	Component Changes.....	511
	Additional Information about Migration	512
	Migrating to 7.0, 7.1, 7.2, 7.5, or 8.0	512
Chapter 29	Configuration Option Changes in IVR Interface Option	513
	IVR Server Configuration Options	513
	IVR Server Changes from 7.5 to 8.0.....	514
	IVR Server Changes from 7.2 to 7.5.....	514
	IVR Server Changes from 7.1 to 7.2.....	514
	IVR Server Changes from 7.0 to 7.1.....	514
	IVR Server Changes from 6.5 to 7.0.....	514
	IVR Driver Configuration Options	515
	IVR Driver Changes from 7.5 to 8.0.....	515
	IVR Driver Changes from 7.2 to 7.5.....	516
	IVR Driver Changes from 7.1 to 7.2.....	516
	IVR Driver Changes from 7.0 to 7.1.....	516
	IVR Driver Changes from 6.5 to 7.0.....	520
Chapter 30	IVR Interface Option Migration Procedures	523
	Upgrading IVR Server	523
	Upgrading from 7.5 to 8.0	523
	Upgrading from 7.2 to 7.5	523
	Upgrading from 7.1 to 7.2	523
	Upgrading from 7.0 to 7.1	523
	Upgrading from 6.5 to 7.x	524
	Upgrading IVR Drivers.....	525
	Upgrading IVR Driver from 6.5 to 7.x.....	527

Chapter 31	Migration from Network T-Server for XML-Based GenSpec to IVR Server	529
	Migration Overview	529
	General Information	530
	Component Compatibility	530
	Configuration Changes	531
	IVR XML Implementations	533
	Message Specification Migration	533
	Message Changes	534
	XML Header: Reference to DTD File	534
	Encoding of Extensions and UserData	535
	Login Flow on Connection Setup	536
	Call Routing Messages	537
	Treatment Messages	538
Part 9	Call Concentrator Migration	547
Chapter 32	Introduction to Call Concentrator Migration	549
	Preliminary Migration Procedures	549
	Reference Materials	550
	Migration Order 7.0	550
	Multi-Site/Single-Site and Multi-Tenant Migration	550
	Migration and Upgrade Order	550
	Interoperability	551
	Compatibility Among Components of Call Concentrator	551
	Additional Information about Migration	552
Chapter 33	Changes in Call Concentrator 7.0	553
	Changes for 7.0	553
	Changes to Call Concentrator Configuration Options	554
Chapter 34	Call Concentrator Migration Procedures	555
	Migration from 6.1 to 7.0	555
	Preliminary Migration Procedures	555
	Migration Procedures	556
Part 10	Universal Routing Migration	557
Chapter 35	Introduction to Universal Routing Migration	559
	Preliminary Migration Procedures	559

	Database/Operating System Upgrade.....	559
	Preliminary Genesys Migration Procedures	560
	Reference Materials.....	561
	Order of Migration for Universal Routing	561
	Single Site, Multi-Site and Multi-Tenant Migration	561
	Migration and Upgrade Order	562
	Interoperability Among Universal Routing Components.....	563
	Universal Routing Component Compatibility	564
	Availability of New Features and Capabilities.....	566
	7.6 Feature and Component Matrix.....	566
	7.5 Feature and Component Matrix.....	576
	7.2 Feature and Component Matrix.....	582
	Routing Component Compatibility	586
Chapter 36	Changes in Universal Routing Through 7.6.....	591
	Component Changes for Universal Routing	592
	Configuration Option Changes	593
	Changes to Functions.....	600
	Changes to Strategy-Building Objects.....	608
	Changes to Predefined Statistics	611
Chapter 37	Universal Routing Migration Procedures.....	615
	Migration of Universal Routing from 6.5 or 7.x to 7.6	615
	Preliminary Procedures	615
	Migration Procedure	616
	Migration of Universal Routing from 5.1, 6.0, or 6.1 to 7.5	619
Part 11	Voice Callback Migration.....	621
Chapter 38	Introduction to Voice Callback Migration.....	623
	Preliminary Migration Procedures	623
	Database and Operating System Upgrade.....	623
	Preliminary Migration Procedures.....	624
	Order of Migration for 7.1	625
	Multi-Site/ Single-Site and Multi-Tenant Migration	625
	Migration and Upgrade Order	625
	Interoperability Among Voice Callback Components.....	627
	Compatibility Among Components of Voice Callback.....	628

Chapter 39	Changes in Voice Callback 7.1	631
	Component Changes for Voice Callback.....	632
	Changes to Configuration Options for Voice Callback 7.0 and 7.1.....	633
Chapter 40	Voice Callback Migration Procedures	643
	Migration from 6.5 and 7.0 to 7.1.....	643
	Preliminary Procedures	643
	Migration Procedures.....	644
Part 12	Voice Treatment Option Migration	649
Chapter 41	Migrating Voice Treatment Option.....	651
	General Instructions for VTO 7.0.....	652
	Before Migrating VTO	652
	Component Changes from 6.5 Through 7.0	652
	New in the Release 7.0.1 VTO	653
	New in the Release 7.0 VTO	653
	Component Compatibility for VTO 7.0.....	653
	Migration to VTO 7.0	655
	VTO Upgrade Procedures	656
Part 13	Workforce Management Migration	679
Chapter 42	Workforce Management Migration Procedures.....	681
	Migration Overview.....	682
	Prerequisites.....	683
	Deploying Workforce Management	684
	Migration from WFM 6.x to WFM 7.0	
	and to WFM 7.1	686
	Migration Warnings	686
	Migrate WFM 6.x to WFM 7.0.....	686
	Update WFM 7.0. to WFM 7.1	688
	Rollback Instructions.....	688
	Large Data Set Migration.....	688
	Updating from WFM 7.x to WFM 7.6.1	689
	Verify Your Connections.....	690
	Migration from WFM 6.x to WFM 7.6.1.....	691
	Migration Warnings	691
	Migrate WFM 6.x to WFM 7.6.1	691
	Verify Your Connections.....	693

	Two-Step Migration.....	693
	Changes from WFM 6 to WFM 7	694
	Changes from WFM 7.x to WFM 7.6	697
	Troubleshooting	700
	Install the Microsoft ODBC Data Source	700
	Install the Microsoft .NET Framework.....	701
	Verify Your Connections.....	701
Part 14	Interaction Concentrator Migration	703
Chapter 43	Migration Order for Interaction Concentrator	705
	Preliminary Migration Procedures	705
	Reference Materials.....	706
	Order of Migration.....	707
	Multi-Site/Single-Site and Multi-Tenant Migration	707
	Migrating from Interaction Concentrator 7.2, 7.5, or 7.6	707
	Interoperability Among Interaction Concentrator Components.....	708
	Additional Information about Migration	709
Chapter 44	Changes in Interaction Concentrator	711
	Component Changes for Interaction Concentrator.....	711
	Changes to Configuration Options for Interaction Concentrator.....	718
	Changes to Interaction Database	725
	IDB Changes from Release 7.6.1 to 8.0	725
	IDB Changes from Release 7.2 to 7.6.x	727
Chapter 45	Migration Procedures.....	735
	Migration to Release 8.0.....	735
	Migration Procedures.....	736
	Migration to Release 7.x.....	741
	Migration Procedures.....	741
Part 15	Genesys Info Mart Migration	755
Chapter 46	Introduction to Genesys Info Mart Migration.....	757
	Preliminary Migration Procedures	758
	Supporting Software Components.....	759
	Recommendations.....	760
	Genesys Info Mart Migration Matrix.....	761
	Reference Materials	763

Chapter 47	Changes in Genesys Info Mart 7.x	765
	Content Changes in Genesys Info Mart 7.6	766
	Content Changes in Genesys Info Mart 7.5	770
	Content Changes in Genesys Info Mart 7.2	772
	Content Changes in Genesys Info Mart 7.0.2	774
	Configuration Option Changes in Genesys Info Mart 7.6	775
	Configuration Option Changes in Genesys Info Mart 7.5	781
	Configuration Option Changes in Genesys Info Mart 7.2	786
	Configuration Option Changes in Genesys Info Mart 7.0.2	791
	Schema Changes in the Info Mart Database 7.6.....	792
	Schema Changes in the Info Mart Database 7.5.....	797
	Schema Changes in the Info Mart Database 7.2.....	800
	Schema Changes in the Info Mart Database 7.0.2.....	807
Chapter 48	Genesys Info Mart Migration Procedures	809
	Migrating Genesys Info Mart from 7.5.x to 7.6.x.....	810
	Migration Roadmap	810
	Migration Planning	810
	Pre-Migration Procedure.....	811
	Migration Procedure	814
	Migrating Genesys Info Mart from 7.2.x to 7.6.x.....	828
	Migrating Genesys Info Mart from 7.0.2 to 7.6.x	829
	Migrating Genesys Info Mart from 7.2.x to 7.5.x.....	829
	Migration Planning	829
	Pre-Migration Procedure.....	831
	Migration Procedure	831
	Migrating Genesys Info Mart from 7.0.2 to 7.5.x	837
	Migrating Genesys Info Mart from 7.0.2 to 7.2.x	837
	Migration Planning	837
	Pre-Migration Procedure.....	839
	Migration Procedure	841
	Modifying Your Call Concentrator Database.....	848
	Configuration Changes	850
	Verifying Option Dependencies	850
	Migrating Genesys Info Mart from 7.0.1 to 7.0.2	851
	Migration Planning	851
	Pre-Migration Procedure.....	852
	Migration Procedure	854
	Configuration Changes	857

Part 16	Expert Contact Migration	863
Chapter 49	Introduction to Genesys Expert Contact Migration	865
	Preliminary Migration Procedures	865
	Preliminary Genesys Migration Procedures	865
	Reference Materials	866
	Migration Considerations	866
	Single Site, Multi-Site, and Multi-Tenant Migration	866
	Redundant T-Servers	867
	Expert Impact	867
	Licensing	867
	Backward Compatible	868
	CTI-Less T-Server Enhancements	868
	Migration and Upgrade Order	868
	Interoperability Among Genesys Expert Contact Components	869
	CTI-Less T-Server Interoperability	870
	Genesys Expert Contact Compatibility	870
	Changes in Genesys Expert Contact	871
	Component Changes for Genesys Expert Contact 7.x	872
	Configuration Option Changes for Expert Contact	872
Chapter 50	Genesys Expert Contact Migration Procedures	875
	CTI-Less T-Server Migration	875
	Licensing	875
	CTI-Less T-Server Migration Procedures	876
	Deploying CTI-Less T-Server 7.2 in a 6.x Environment	878
	GCN Web and Genesys Desktop	879
Part 17	Multimedia Migration	881
Chapter 51	Migration Order for Multimedia	883
	Preliminary Migration Procedure	883
	Multi-Site and Multi-Tenant Migration	884
	Interoperability Among Multimedia Components	884
	Compatibility Between Multimedia/MCR and Genesys Framework	885
	Compatibility Among Components of Multimedia	887
Chapter 52	Changes in Components and Configuration Options	897
	Component Changes	898
	Multi-Channel Routing 7.1	898

	Multimedia 7.2	898
	Multimedia 7.5	898
	Multimedia 7.6.0	899
	Multimedia 7.6.1	899
	Multimedia 8.0	899
	Changes to Configuration Options	899
	Multi-Channel Routing Changes from 7.0 to 7.1	899
	Multi-Channel Routing 7.1 to Multimedia 7.2	902
	Multimedia 7.2 to 7.5	904
	Multimedia 7.5 to 7.6.0	905
	Multimedia 7.6.0 to 7.6.1	907
	Multimedia 7.6.1 to 8.0	909
Chapter 53	Migration Procedures.....	911
	Overview.....	911
	MCR 7.0 to MCR 7.1	911
	MCR 7.1 to Multimedia 7.2	912
	Multimedia 7.2 to 7.5	912
	Multimedia 7.5 to 7.6.0	912
	Multimedia 7.6.0 to 7.6.1	913
	Multimedia 7.6.1 to 8.0	913
	Migration Procedures	914
	Contact Center Information.....	914
	Solution and Components	914
	Databases.....	917
	Web Portal	923
	Other Data and Objects	924
Part 18	Genesys Voice Platform 7.x Migration.....	925
Chapter 54	Upgrading to Genesys Voice Platform 7.6.....	927
	GVP 7.5 to GVP 7.6	927
	GVP 7.2.x to GVP 7.6.....	934
	GVP: EE 7.2.x to GVP 7.6	935
	GVP: NE 7.2.x to GVP 7.6.....	940
	GVP 7.0.3 to GVP 7.6	949
	GVP 6.5.x to GVP 7.6.....	949
Chapter 55	Upgrading to Genesys Voice Platform 7.5.....	951
	Considerations when Migrating to Genesys Voice Platform 7.5.....	952
	Overview.....	952

GVP Deployment Tool	953
Upgrading GVP to GVP 7.5	953
EMPS	956
Migrating Data	957
Using the Data Migration Tool.....	957
Upgrading Components.....	965
Upgrading VCS	965
Upgrading IP Call Manager	966
Upgrading IPCS	966
Upgrading EventC and Reporting	967
Upgrading Policy Manager	969
Upgrading Bandwidth Manager	969
Upgrading IVR Server Client	969
Upgrading the Cisco Queue Adapter.....	970
Upgrading ASR Log Manager Components	970
Upgrading Outbound Notification.....	970
Upgrading Databases.....	971
Upgrading Network Monitor Database.....	971
Upgrading Collector Database.....	971
Upgrading Peaks Database.....	972
Upgrading Reporter Database.....	972
Upgrading RepDWH Database.....	973
Upgrading UnifiedLogin Database.....	974
Additional Database Maintenance Activities	974
Upgrade Considerations.....	976
EventC	976
Policy Manager	977
Bandwidth Manager.....	978
IVR Server Client	979
Cisco Queue Adapter	980
Configuring ASR Log Manager for MRCP	982
Call Manager (SIP)	983
Upgrading from Windows 2000 to Windows 2003.....	987
Chapter 56	
Migration for Genesys Voice Platform: Network Edition.....	989
Introduction.....	990
Deployment Sequence	990
Loading New MIB	991
Upgrading EMPS.....	991
Upgrading EMS1 Components.....	992
Upgrading EMS2 Components.....	993
Migrating EventC and Reporting.....	993
Upgrading Voice Platform Call Manager.....	1004

	Upgrading VCS	1005
	Upgrading IPCS	1007
	Upgrading TTS	1007
	Upgrading ASR.....	1008
	Upgrade Considerations for Voice Applications.....	1008
Chapter 57	Migration for Genesys Voice Platform: Enterprise Edition	1009
	Migration Strategy	1009
	Migrating Third-Party Software.....	1010
	Migrating from OSR to MRCP ASR.....	1010
	Migrating from Speechify to MRCP TTS.....	1010
	Migrating from RealSpeak to MRCP TTS	1011
	Upgrading Dialogic	1011
	Migrating GVP: EE using Solution Installer	1012
	Migrating when GVP:EE was previously installed	1012
	Migrating when Previous Deployment was Manually Installed	1021
	Migrating GVP: EE without Solution Installer	1023
Chapter 58	Migration for Genesys Voice Platform: Developer's Edition.....	1025
	Migration Strategy	1025
	Migrating Third-Party Software.....	1026
	Migrating from OSR to MRCP ASR.....	1026
	Migrating from Speechify to MRCP TTS.....	1026
	Migrating from RealSpeak to MRCP TTS	1027
	Migrating Genesys Voice Platform: Developer's Edition	1027
Chapter 59	Migration for Genesys Voice Platform: Studio	1029
	Migration Considerations.....	1029
	Windows 2003 Specifics.....	1029
	VoiceXML 2.1 W3C R Support	1030
	VoiceXML 2.0 W3C R Support	1030
	ASR Engine Support.....	1031
	TTS Engine Support	1032
	OSDM Support	1032
	Exception Handling.....	1033
	Recording Support.....	1034
	Upgrading to Studio 7.6.....	1034
	Upgrading to 7.6	1035
	Upgrading to Studio 7.5.....	1036
	Upgrading to 7.5	1037
	Upgrading to Studio 7.2.....	1038

	Upgrading Studio to 7.2	1039
	Upgrading to Studio 7.0.3.....	1040
	Upgrading to 7.0.3	1041
Chapter 60	Migration for Genesys Voice Platform: VAR.....	1043
	Upgrading VAR to 7.6.....	1043
	Upgrading VAR to 7.5.....	1045
	Upgrading VAR to 7.2.....	1048
	Upgrading VAR to 7.0.3.....	1049
Part 19	Genesys Voice Platform 8.x Migration.....	1051
Chapter 61	Upgrading to GVP 8.x.....	1053
	Preliminary Migration Procedures	1053
	Reference Materials.....	1054
	Order of Migration.....	1054
	Interoperability Among Components	1056
	Compatibility Among Components	1057
Chapter 62	Changes in GVP 8.1 and GVP 8.1.1.....	1059
	Changes in GVP 8.1	1059
	8.1 Component Changes.....	1060
	8.1 Configuration Option Changes	1065
	8.1 Reporting Server Database Changes	1073
	Changes in GVP 8.1.1.....	1074
	8.1.1 Component Changes.....	1075
	8.1.1 Configuration Option Changes	1078
	8.1.1 Reporting Server Database Changes.....	1084
Chapter 63	Migration Procedures for GVP 8.x	1087
	Migration of GVP 8.0 and 8.1	1087
	Procedures to Migrate GVP 8.0.....	1088
	Procedures to Migrate GVP 8.1	1092
	Migrating the Reporting Server Databases.....	1094
	Rollback Procedures	1096
	High Availability Migration	1099
Chapter 64	Migration Procedures for GVP 7.6	1101
	Migration of GVP 7.6	1101
	Migration Strategy.....	1104

	Procedures to Migrate GVP 7.6.....	1105
	Common Configuration Mappings.....	1107
	Component Configuration Mapping.....	1108
	IVR Server Configuration Mapping.....	1115
	Reporting Component Mapping.....	1120
	Outbound Notification Mapping.....	1120
	SNMP Trap Mapping.....	1121
	System Prompts Migration.....	1124
Part 20	The Gplus Adapter 7 for mySAP ERP Migration ..	1127
Chapter 65	Introduction to the Gplus Adapter 7 for mySAP ERP Migration..	1129
	Preliminary Migration Procedures.....	1129
	Reference Materials.....	1130
	Migration and Upgrade Order.....	1130
	Additional Information about Migration.....	1131
	Differences in Call Handling.....	1131
	Differences in Call-Attached Data Handling.....	1132
Chapter 66	Changes in Configuration Options for the Gplus Adapter 7 for mySAP ERP.....	1137
	Changes to Configuration Options for the Gplus Adapter.....	1138
Chapter 67	Migration Procedures.....	1145
	Migration of 6.1 T-Gate to the Gplus Adapter 7 for mySAP ERP.....	1145
	Configuring Places for T-Gate Multi-DN Telesets.....	1147
	Migrating Queue Configuration.....	1149
Part 21	The Gplus Adapter for Siebel CRM Migration	1155
Chapter 68	Introduction to the Gplus Adapter for Siebel CRM Migration	1157
	Preliminary Migration Procedures.....	1157
	Reference Materials.....	1158
Chapter 69	Changes in Gplus Adapter for Siebel CRM.....	1161
	Component Changes for the Gplus Adapter for Siebel CRM.....	1162
	Changes to the Configuration Options.....	1165
	Architectural Changes.....	1166

Chapter 70	Migration Procedures	1167
	Migration Procedures for the Gplus Adapter for Siebel CRM.....	1167
	Prerequisite Migration for the Gplus Adapter for Siebel CRM.....	1168
	Migration Procedures	1169
	Upgrading a Customized GenComm7_universal.def or GenComm_universal.def File	1172
Part 22	The Gplus Adapter for PeopleSoft CRM	1175
Chapter 71	Introduction to the Gplus Adapter for PeopleSoft CRM Migration	1177
	Before You Begin.....	1177
	Prerequisite Migration Procedures	1178
	Reference Materials	1178
Chapter 72	Migration Procedures	1179
	Migrating the Gplus Adapter for PeopleSoft CRM.....	1179
	Migration Procedures.....	1180
	Migrating the Adapter from Release 7.0 to 7.1	1180
	Upgrading to PeopleTools 8.47	1181
	Backing Up the Customization Points.....	1181
	Uninstalling the 7.0.0/7.0.1 Adapter.....	1181
	Importing the Adapter 7.1 Template.....	1182
	Creating the Application Object	1182
	Configuring the Adapter	1182
	Installing a Warm Standby Adapter (Optional).....	1182
	Migrating from Release 7.0 or 7.1 to 7.2	1182
	Migration Procedures.....	1183
	Migrating the Adapter from Release 7.0 or 7.1 to 7.2.....	1183
	Upgrading to PeopleTools 8.48.....	1184
	Backing Up the Customization Points.....	1184
	Uninstalling the 7.0.0/7.0.1/7.1.0 Adapter.....	1185
	Importing the Adapter 7.2 Template.....	1185
	Creating the Application Object	1185
	Configuring the Adapter	1185
	Installing a Warm Standby Adapter (Optional).....	1185

Part 23	Appendices	1187
Appendix A	Login Procedure	1189
Appendix B	Configuration Server Proxy Log Events Mapping.....	1191
Appendix C	Genesys Desktop and Related Products.....	1203
Index	1205



Preface

Welcome to the *Genesys Migration Guide*. The Genesys migration process involves the transition of current Genesys installations at customer sites to new releases of Genesys products and solutions.

This guide provides system-level information for the Genesys 7.x and 8.x releases to date, and assists the migration team in performing the migration process at customer contact centers.

Note: To consult previous versions of this guide, please visit the Genesys Technical Support Website.
Or, order the Documentation Library DVD from Genesys Order Management by email at orderman@genesyslab.com.

You will find the following information in *Genesys Migration Guide*:

- Information for effective planning and execution of Genesys software migrations: from releases 6.x to 7.x., from releases 7.x to higher releases of 7.x., and to some 8.x releases.
- Interrelationships among Genesys products that are significant in negotiating the migration process.
- Step-by-step procedures for each stage of the migration process.

This Preface discusses the following topics:

- [Intended Audience, page 28](#)
- [Document Conventions, page 28](#)
- [Related Resources, page 30](#)
- [Making Comments on This Document, page 31](#)
- [Contacting Genesys Technical Support, page 31](#)

Intended Audience

The *Genesys Migration Guide* is primarily intended for those involved in the migration process. The following list gives examples of the type of audience who would use this guide.

- Genesys personnel
For example:
 - Genesys Account Team
 - Professional Services
 - Technical Support
 - System engineer(s)
- Members of the migration teams at customer sites
For example:
 - Lead architect
 - Team project manager(s)
 - Implementation specialists for the various components and migration phases

This guide assumes that you have a basic understanding of:

- Computer-telephony integration (CTI) concepts, processes, terminology, and applications.
- Network design and operation.
- Your company's network configuration.
- Genesys Framework architecture and functions.

Document Conventions

This document uses certain stylistic and typographical conventions—introduced here—that serve as shorthands for particular kinds of information.

Document Version Number

A version number appears at the bottom of the inside front cover of this document. Version numbers change as new information is added to this document. Here is a sample version number:

72gets_ad_03-2006_v7.2.001.00

You will need this number when you are talking with Genesys Technical Support about this product.

Type Styles

Italic

In this document, italic is used for emphasis, for documents' titles, for definitions of (or first references to) unfamiliar terms, and for mathematical variables.

- Examples:**
- Please consult the *Genesys Migration Guide* for more information.
 - *A customary and usual practice* is one that is widely accepted and used within a particular industry or profession.
 - Do *not* use this value for this option.
 - The formula, $x + 1 = 7$ where x stands for . . .

Monospace Font

A monospace font, which looks like teletype or typewriter text, is used for all programming identifiers and GUI elements.

This convention includes the *names* of directories, files, folders, configuration objects, paths, scripts, dialog boxes, options, fields, text and list boxes, operational modes, all buttons (including radio buttons), check boxes, commands, tabs, CTI events, and error messages; the values of options; logical arguments and command syntax; and code samples.

- Examples:**
- Select the Show variables on screen check box.
 - Click the Summation button.
 - In the Properties dialog box, enter the value for the host server in your environment.
 - In the Operand text box, enter your formula.
 - Click OK to exit the Properties dialog box.
 - The following table presents the complete set of error messages T-Server[®] distributes in EventError events.
 - If you select true for the inbound-bsns-calls option, all established inbound calls on a local agent are considered business calls.

Monospace is also used for any text that users must manually enter during a configuration or installation procedure, or on a command line:

- Example:**
- Enter exit on the command line.

Screen Captures Used in This Document

Screen captures from the product GUI (graphical user interface), as used in this document, may sometimes contain a minor spelling, capitalization, or grammatical error. The text accompanying and explaining the screen captures corrects such errors *except* when such a correction would prevent you from

installing, configuring, or successfully using the product. For example, if the name of an option contains a usage error, the name would be presented exactly as it appears in the product GUI; the error would not be corrected in any accompanying text.

Square Brackets

Square brackets indicate that a particular parameter or value is optional within a logical argument, a command, or some programming syntax. That is, the parameter's or value's presence is not required to resolve the argument, command, or block of code. The user decides whether to include this optional information. Here is a sample:

```
smcp_server -host [/flags]
```

Angle Brackets

Angle brackets indicate a placeholder for a value that the user must specify. This might be a DN or port number specific to your enterprise. Here is a sample:

```
smcp_server -host <confighost>
```

Related Resources

Further information on supported hardware and third-party software is available on the Genesys Technical Support website in the following documents:

- *Genesys Supported Media Interfaces Reference Manual* provides detailed information for the supported media interfaces for Genesys products.
- *Genesys Supported Operating Environment Reference Manual* provides information about the supported operating systems and databases required to run Genesys applications.

Consult these additional resources as necessary:

- *Genesys Technical Publications Glossary* provides a comprehensive list of the Genesys and CTI terminology and acronyms used in this document.
- *Genesys 7 Hardware Sizing Guide* provides information about Genesys hardware sizing guidelines for the Genesys releases.
- *Genesys 7 Interoperability Guide* and the *Genesys 8 Interoperability Guide* provide information on the compatibility of Genesys products with various Configuration Layer Environments; Interoperability of Reporting Templates and Solutions; and *Gplus* Adapters Interoperability.
- *Genesys Licensing Guide* introduces you to the concepts, terminology, and procedures relevant to the Genesys licensing system.

- *Genesys 7.6 Database Sizing Estimator Worksheets* provides a range of expected database sizes for various Genesys 7.6 products.
- The Release Notes and Product Advisories for Genesys products are available on the Genesys Technical Support website at <http://genesyslab.com/support>.

Genesys product documentation is available on the:

- Genesys Technical Support website at <http://genesyslab.com/support>.
- Genesys Documentation Library DVD, which you can order by e-mail from Genesys Order Management at orderman@genesyslab.com.

Making Comments on This Document

If you especially like or dislike anything about this document, please feel free to e-mail your comments to Techpubs.webadmin@genesyslab.com.

You can comment on what you regard as specific errors or omissions, and on the accuracy, organization, subject matter, or completeness of this document. Please limit your comments to the information in this document only and to the way in which the information is presented. Speak to Genesys Technical Support if you have suggestions about the product itself.

When you send us comments, you grant Genesys a nonexclusive right to use or distribute your comments in any way it believes appropriate, without incurring any obligation to you.

Contacting Genesys Technical Support

If you have purchased support directly from Genesys, contact Genesys Technical Support at the following regional numbers:

Region	Telephone	E-Mail
North America and Latin America	+888-369-5555 (toll-free) +506-674-6767	support@genesyslab.com
Europe, Middle East, and Africa	+44-(0)-1276-45-7002	support@genesyslab.co.uk
Asia Pacific	+61-7-3368-6868	support@genesyslab.com.au
Malaysia	1-800-814-472 (toll-free) +61-7-3368-6868	support@genesyslab.com.au
Before contacting technical support, refer to the <i>Genesys Technical Support Guide</i> for complete contact information and procedures.		

Region	Telephone	E-Mail
India	1-800-407-436379 (toll-free) +91-(022)-3918-0537	support@genesyslab.com.au
Japan	+81-3-6361-8950	support@genesyslab.co.jp
Before contacting technical support, refer to the <i>Genesys Technical Support Guide</i> for complete contact information and procedures.		



Part

1

Overview of Migration Process

This Part of the *Genesys Migration Guide* presents an overview of the migration process and contains the following chapters:

Note: This migration information includes 7.x products as new 7.x versions are released, and 8.x products as new 8.x versions are released, as well as any changes to support information for maintenance versions of previously released products.

- Chapter 1, “Migration Roadmap,” on page 35 discusses migration and upgrade, preparations for the migration process, and different approaches to migration, including Genesys’ recommended approach with rollback procedures.
- Chapter 2, “Licensing Migration,” on page 41 discusses procedures for upgrading your licensing system.



Chapter

1

Migration Roadmap

Migration is a transitional process during which an existing customer who has installed Genesys products and solutions acquires new releases of these products and solutions.

For some clients, migration might include installing new Genesys products (deployment) or expanding the existing solutions to include new components (upgrade).

This chapter introduces you to the migration process and discusses the following topics:

- [Overview of Migration Process, page 36](#)
- [Migration/Upgrade Order, page 36](#)
- [Preparations for Migration, page 37](#)
- [Approaches to Migration, page 38](#)
- [Solutions/Components and Environment Compatibility, page 39](#)

Note: This guide includes 7.0.x and 7.x products, and some 8.x products. The product information will continue to be updated as additional 7.x and 8.x versions are released.

Overview of Migration Process

Figure 1 shows the scope of the Genesys migration process.

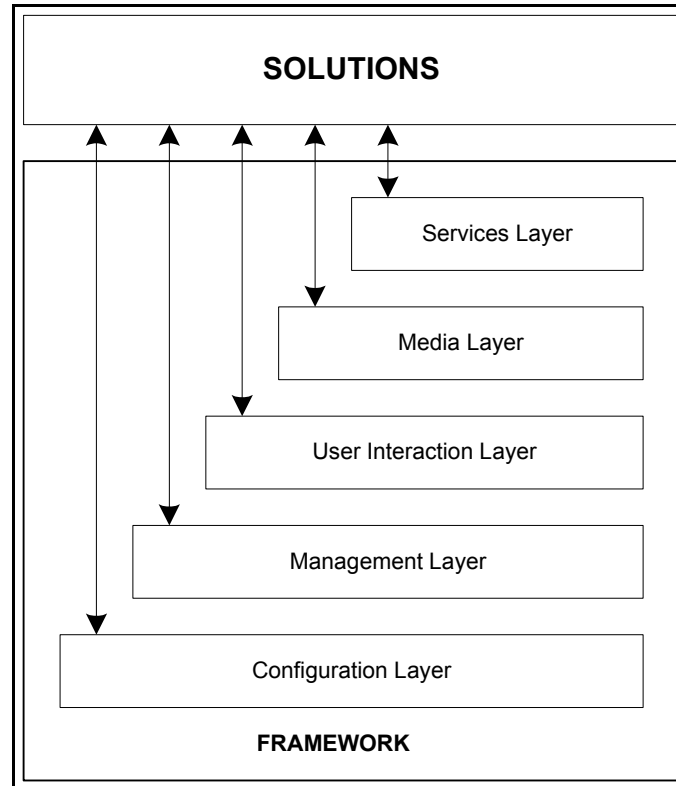

Figure 1: Scope of Migration

See *Framework 8.0 Deployment Guide* for an explanation of the different layers.

Migration/Upgrade Order

Migration is generally done in the following order:

1. Install License Manager 9.5.
See Chapter 2, “Licensing Migration,” on [page 41](#) and chapters on specific solutions in this guide for components that require licensing.
2. Upgrade your hardware and your operating system and/or database, if necessary.
This must be done before migrating your Genesys product.

Note: See the *Genesys 7 Interoperability Guide* and the *Genesys 8 Interoperability Guide* for information on the compatibility of Genesys products with various Configuration Layer Environments; Interoperability of Reporting Templates and Solutions; and *Gplus* Adapters Interoperability; and contact Technical Support for deployment instructions before migrating Configuration Layer.

3. Upgrade Configuration Server Proxy (if applicable).
For further information about the Configuration Server Proxy, see Part Two, “Framework Migration” on [page 57](#) in this guide.
4. Set up the migration environment, including Configuration Conversion Wizard (CCW).
See Part Two, “Framework Migration” on [page 57](#) in this guide.
5. Use CCW to convert existing data structures from Configuration Database into appropriate 7.x format.
6. Upgrade Configuration Layer.
For further information about the Configuration Layer, see Part Two, “Framework Migration” on [page 57](#) in this guide.
7. Upgrade Management Layer.

Note: This can also be done later since Local Control Agent (LCA) 7.0.1 is compatible with LCA 7.2.

8. Upgrade core components.
See Part Two, “Framework Migration” on [page 57](#) in this guide for Stat Server upgrade instructions and Part Five, “T-Server Migration” on [page 299](#) in this guide.
9. Migrate Solution components.
See chapters on specific solutions in this guide.

Preparations for Migration

Preparing for migration and analyzing the business and operational environment are necessary for a successful migration.

1. Genesys Account Team works with the customer to do the following:
 - Identify the company’s reasons for migrating to the latest release of Genesys solutions.
 - Define the roles and responsibilities of the participants in the migration process.

2. Genesys then provides the software and technical assistance to ensure a successful migration.
3. If Professional Services (PS) is engaged, the Account Team informs the PS representative of the company's customized needs.

Note: Genesys strongly recommends that anyone considering migration should engage Genesys Professional Services for the task.

4. Training of the migration team and contact center personnel using and maintaining the new system is arranged at the customer site.

Note: Several training classes are available for customers engaged in the migration project. A complete listing may be found on the Genesys website.

5. Analysis of the customer's business and operational environment by the Genesys Professional Service Architecture Practice team, a Customer Care Manager (CCM), or a system engineer includes:
 - Becoming familiar with the customer's existing system management and business requirements.
 - Examining the existing technology of the company's contact center and its overall architecture (network, hardware, and software).
 - Identifying anticipated growth or other changes in the company's operations.

Approaches to Migration

There are several different approaches to migration.

Basic Approaches

- Overnight approach
In the overnight approach, all of the current applications are turned off and the new 7.x applications are turned on in one night.
- Phased approach (component-based)
The component-based, phased approach turns off all the applications of the same type or all the components of a specific solution and then turns on new versions of those same-type applications or solution-specific components. (Same-type applications include all T-Servers; an example of all components of one solution is Enterprise Routing components.)
- Phased approach (site-by-site)
The site-by-site phased approach migrates all of the Genesys applications one site at a time until all of the company sites are migrated. This approach starts with the site or data center that contains the Configuration Database and the Configuration Server.

- Rollback procedures

**Rollback
Procedures**

The *Genesys Migration Guide* presents an approach that Genesys recommends, which includes rollback procedures at each major step in the migration process. The purpose of the rollback procedures is to secure the system against loss of data or functionality during the migration. Should the need arise, the rollback procedures can return a newly installed component to its original condition before migration.

Solutions/Components and Environment Compatibility

Interoperability between 6.1, 6.5, 7.0.x, and 7.x components is discussed in the solution sections in this guide. For example, operating in a mixed environment involves working with 7.2 components in a 7.1 environment, 7.0 components in a 6.x environment, or 6.x components in a 7.0 environment. Also, some 8.x migration paths, and additional 8.x products are being added as new products are released.



Chapter

2

Licensing Migration

This chapter discusses how to upgrade your licensing system, which is implemented through the License Manager (FLEXlm lmgrd), vendor daemon, and license file.

This chapter contains the following topics:

- [License Control Architecture, page 41](#)
- [License Control Configurations, page 44](#)
- [Upgrading Licensing System, page 47](#)
- [Upgrading Licensing System with Multiple Vendors, page 53](#)

In migrating from Genesys 6.x to Genesys 7.x, you can use the 6.x and 7.x license control features specified in the license file. Existing 6.x components can use the 6.x license features, while 7.x components can use the 7.x license features.

License Control Architecture

FLEXlm License management for Genesys products is based on FLEXlm.

For details on FLEXlm, please consult the following documents:

- *FLEXlm End User Guide Version 9.5*
- *FLEXlm Reference Manual Version 9.5*

Note: These documents are included on the Genesys 7.6 Management Framework DVD.

In general, all FLEXlm features are supported by Genesys. Exceptions are described in the *Genesys Licensing Guide*. For example:

- Do not use environment variable `LM_LICENSE_FILE` to specify location of license file.
- Consult restrictions concerning host ID specification.

License Control Architecture Components

The license control architecture contains the following components:

1. License Manager (FLEXlm) daemon

- `lmgrd` initiates commerce with the client applications and passes the connection to the appropriate vendor daemon.
- LM starts and restarts the vendor daemons.

Note: Genesys 5.x and 6.x applications require FLEXlm License Manager 6.1, or higher. Genesys 7.x applications require FLEXlm License Manager 8.3, or higher. Genesys applications for RedHat Linux Enterprise require FLEXlm License Manager 9.5.

2. Genesys vendor daemon

- Genesys vendor daemon records number of licenses checked out and who has them checked out.
- Licenses are activated when `lmgrd` starts or restarts the vendor daemon.
- Genesys vendor daemon is called `genesys.d` for UNIX and `genesys.d.exe` for Windows.

License server refers to FLEXlm and associated Genesys vendor daemon.

Note: Multiple vendor daemons on the same server machine are only possible if they are from different vendors. This could be the case if FLEXlm is used to control both Genesys applications and other third-party software. See “Upgrading Licensing System with Multiple Vendors” on [page 53](#).

3. License file

Note: All Genesys license files are built in FLEXlm 4 compatibility mode.

- Licensing data is contained in a text file called `license.dat` that has information about the license server(s) host name, port, license server host ID, the vendor daemon(s), and at least one line of data, called a FEATURE line, for each licensed product.

Note: The license file is named “`license.dat`” throughout the document. However, the name of the license file can be changed.

- All license files are locked to a given computer identified by its hostID.
- The license file is authenticated, and some parts of it can be modified without invalidating the license file. In particular, users can add FEATURE lines for Genesys 7.x products to the available Genesys 6.x license file if both have been generated for the same host.
- Genesys license file contains FEATURE lines both for purchased saleable items and for additional internal technical license controls.
- Each feature contains a version number.

Genesys 7.x applications require version 7.x in the license file.

Note: Throughout this document, it is assumed that only one license file is used per license server. For possible additional configurations with multiple license files, refer to the FLEXlm documentation.

4. Application Program

- Genesys applications are built with the FLEXlm library that provides communication with the license server.
- Genesys applications that require licensing communicate with the license server to request a license.

Note: For Genesys 7.x applications, the options for configuring licensing information can be specified in the startup script (as in Genesys 6.x) and alternatively in the Configuration Server. See *Genesys Licensing Guide* for details.
Please check application specific information for possible exceptions: for example, Call Concentrator 7.0 only supports specification of license information in the startup script.

5. FLEXlm Tools

- FLEXlmtools allow user to start/monitor/stop the license server.

Version Compatibility

The following rules concerning compatibility between FLEXlm products apply:

Version of lmutil/LMT00L

 >Version of lmgrd

 >Version of vendor daemon

 >Version of FLEXlm-licensed application

 >Version of license file format

Note: In compatibility rules, version refers to FLEXlm.

The Genesys 7.x License Server is built with FLEXlm 9.5, and because of compatibility rules it works with the following:

- Previously issued license files and also new license files for Genesys 7.x.
- Previous Genesys applications and also new Genesys 7.x applications.

License Control Configurations

The licensing system supports these server configurations:

Note: The supported license control configurations are the same as for previous Genesys releases.
The described configurations relate to the license control components only. Applications can run either on the same computer(s) as the license server(s) or on different computers.

Single-Server Configuration

1. Single-Server Configuration: See [Figure 2](#) below.

There is one computer host with:

- **One license server**
 - One FLEXlm License Manager and Genesys vendor daemon are on server.
- **Associated Genesys license file**
 - File is locked to the given host and points to the license server.

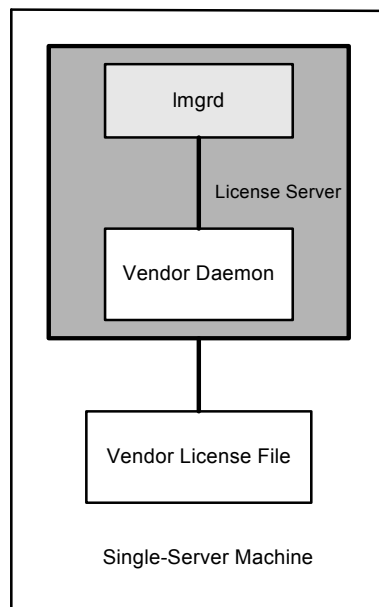

Figure 2: Single-Server Configuration

See “Single-Server Configuration” in *Genesys Licensing Guide*.

Multiple, Independent Servers Configuration

2. Multiple, Independent Servers Configuration: See Figure 3 on [page 45](#).

This configuration contributes to high availability because the failure of one license server impacts only the portion of the licenses it is controlling.

There are multiple computer hosts with:

- ♦ **Multiple license servers**
 - ♦ One license server (FLEXlm License Manager and Genesys vendor daemon) exists on each host.
 - ♦ License servers are independent and do not communicate with each other.
- ♦ Associated vendor license files
 - ♦ One license file per license server is locked to its host and points to its particular license server.
 - ♦ Each license file contains a portion of the total amount of licenses.

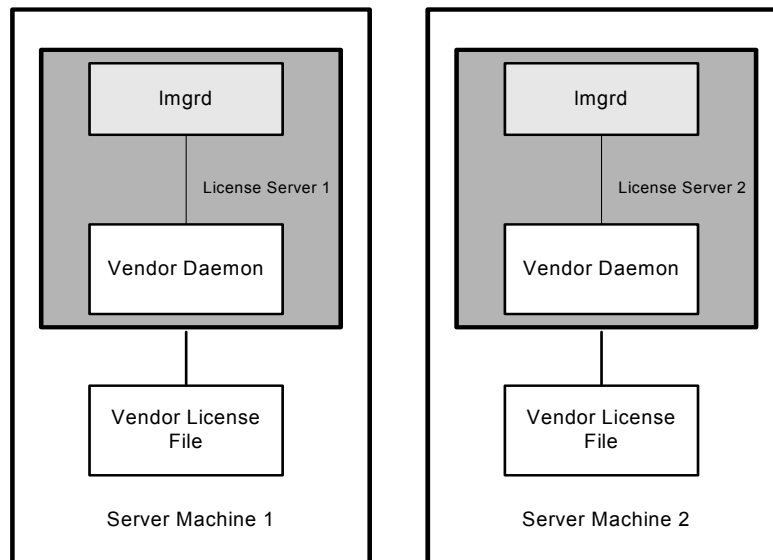

Figure 3: Multiple, Independent Servers Configuration

See “Multiple, Independent Servers Configuration” in *Genesys Licensing Guide*.

Three-Server Redundant Configuration

3. Three-Server Redundant Configuration: See Figure 4 on [page 46](#).

Identical license servers with the same license file run on each of the three computers in a “quorum” configuration. For license checkout, applications interact with the three-server redundancy configuration in the same way as with a single license server.

This configuration contributes to high availability because the failure of one license server does not impact the license control service.

Note: For the three-server redundancy license control system to be operational, at least two license servers must be operational (“quorum”).

There are three computer hosts with:

- ♦ **Three mutually connected license servers**
 - ♦ One license server (FLEXlm License Manager and Genesys vendor daemon) exists on each host.
 - ♦ License servers communicate with each other during runtime.
- ♦ **Associated vendor license files**
 - ♦ Identical copies of the license file are placed on each of the three hosts.
 - ♦ License file is locked to all three hosts.

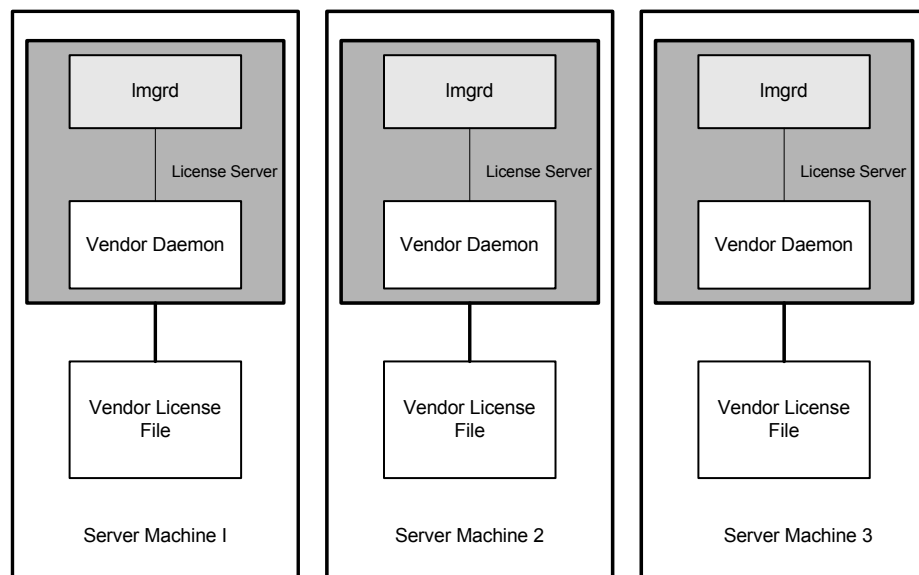

Figure 4: Three-Server Redundant Configuration

Note: Customers need a high-availability license to use any Genesys servers in redundant configurations (for hot standby or warm standby). The license feature name is `ha_redundancy`, and the Solution Control Server (SCS) controls this license.

If the license is unavailable, SCS does not perform a switchover between primary and backup servers when the primary fails.

See Genesys Price List for further information.

See “Three-Server Redundant Configuration” in *Genesys Licensing Guide*, and “Upgrading Three-Server Redundancy” on [page 52](#).

Upgrading Licensing System

When upgrading a product to 7.x, you should always check if there is a need for a licensing upgrade. For a complete list of products and components that perform license checking, see *Genesys Licensing Guide* or contact Genesys Technical Support.

In most cases, the same configuration as the current one is chosen for the new license control system. These migration scenarios are described below.

However, it is also possible to change the license control configuration when upgrading (for example, replace a single-server configuration with a three-server redundancy configuration). In this situation, you follow the instructions for first installing the selected new target configuration and then removing the current configuration.

Note: Genesys recommends that you archive old license file(s), application executables, FLEXlm 6.1 and Genesys 6.x vendor daemon, for use in case of a potential rollback. A rollback is possible for all supported license control configurations.

To Upgrade Licensing Control System

Generally, the following steps have to be followed for upgrading the license control system.

Note: The details depend on the license control configuration, as described in the following chapters.

1. Choose the license control configuration appropriate for your needs. See “License Control Configurations” on [page 44](#).
2. Request the license file for given products, selected configuration, and computer hosts, and copy it to the proper directory.

In general, new licenses are only needed for the components that are updated. If both old and new license files are issued for the same host, it is possible to merge them into one license file. However, depending on the migration option, it would also be possible to issue a completely new license file for both unchanged and upgraded components.

Note: In keeping with the FLEXlm compatibility rules, the new 9.5 license server also supports the old applications and their available FEATURE entries in the license file.

Ensure there is no conflicting information in the resulting license file(s). In particular, if there are multiple entries with the same feature name, the valid entry should remain, and the others should be removed.

You have to remove these double entries; this is not done automatically. If you decide to keep the double entries, only the first line of a given feature

is taken into account, and the other lines are ignored. In addition, this is logged by the license server.

Note: This is particularly relevant for feature names that are the same for Genesys 6.x and 7.x: for example, CIW and GIS. In this case, the feature line with the 7.x version should be kept, and the other line(s) with the same feature should be removed. You must make these changes manually; they are not performed automatically.

3. Install the new License Server 9.5.

The Genesys installation automatically installs both FLEXlm 9.5 License Manager and the new Genesys vendor daemon in the selected target directory.

Note: If your current FLEXlm License Manager is already 8.3 or higher, you should keep it. In this case, the License Manager installed by Genesys should be removed after installation, and if necessary, the new Genesys vendor daemon and other installed files should be copied to the required directory. You must remove the unnecessary License Manager manually; it is not performed automatically.

4. Upgrade the license control system.

The new license server is started by:

```
lmgrd -c license.dat
```

Note: This procedure provides the same functions that were available by using `run.bat` script.

5. Configure and install the new Genesys 7.x components.

License control options for new Genesys 7.x applications have to be specified in the configuration environment. Depending on the application, you might need an additional configuration of objects that are the subject of license control.

Note: The application specific details for license control configuration are described in the application migration chapters in this book.

6. Start the new Genesys 7.x components.

The new Genesys 7.x application can be started and connected to the new license server by one of the following options:

a. Use command line option.

To start a server application with the new license file, specify the following in the startup command line for the application:

-l [license file name or license server location]

- b. Rely on application settings for license control in the Configuration Server for location of license file or *license server port@host address*. See *Genesys Licensing Guide* for further information on how applications can be started.

Note: Generally, Genesys 7.x applications can rely on license configurations in the Configuration Server that do not need command line specifications. However, you should check for application specific exceptions: for example, Call Concentrator 7.0 requires specification in the command line.

7. If everything works correctly, you can uninstall the software that is no longer needed (old application and old license server).

Methods for Upgrading Licensing System

This section describes three methods for upgrading the licensing control system:

- Running old and new versions of license server on different hosts (see “Running Two Versions of License Server” on [page 49](#))
- Replacing the old version of a single license server by a new one (see “Replacing Existing License Server” on [page 50](#))
- Upgrading three-server redundancy (see “Upgrading Three-Server Redundancy” on [page 52](#))

It is not possible to run both old and new Genesys vendor daemons concurrently on the same host.

Note: While replacing your license server, you may continue running your applications. After the new license server is activated, the components that are being migrated can be replaced by the new versions.

Running Two Versions of License Server

With this method, you install the new licensing system while leaving the current system intact. This approach allows an easy rollback to the previous configuration if there are problems.

Note: Running two license servers in parallel is an upgrade option that requires a second computer because the two license servers **MUST** be run on different hosts.

To Run Two Versions of License Server

1. Select a host for License Server 9.5.

Warning! This cannot be the computer where the old license server is installed.

2. Order new licenses from Genesys using information about the selected host.

Note: New licenses are only required for new or updated components. Unchanged components do not need new licenses.

See *Licensing Genesys Products* and *Genesys Licensing Guide* for information on how to order licenses.

3. Install License Server 9.5 on the selected host.

See *Licensing Genesys Products* and *Genesys Licensing Guide* for installation instructions.

4. Set up the license file with license data for 7.x applications on the host for the new License Server 9.5.

See *Licensing Genesys Products* and *Genesys Licensing Guide* for detailed instructions.

5. Start License Server 9.5.

6. Install the Genesys 7.x application, pointing to the new license server or license file.

7. Modify the application configuration for the new Genesys 7.x application, if necessary.

Note: See component sections of this guide to identify application-specific changes in licensing configuration.

8. Stop the 6.x application.

9. Start the 7.x application.

10. Monitor the 7.x application to ensure it is operating correctly.

11. Uninstall the 6.x application if the new system is working correctly.

Replacing Existing License Server

The advantage of this option is that you do not need a second host for running the new License Server 9.5.

To Replace Existing License Server

1. Order new licenses from Genesys using information about the current license server host.

Note: New licenses are only required for new or updated components. Unchanged components do not need new licenses. However, it is possible to issue a completely new license file for both unchanged and upgraded components.

See *Genesys Licensing Guide* for information on how to order licenses.

2. Install License Server 9.5 on the same host, but in a separate directory.

Note: Rollback to the old configuration would be easier if different directories were used.

3. Use the same host and port parameters as with License Server 6.x.

Note: This avoids restarting the old applications after license server upgrade.

See *Genesys Licensing Guide* for installation instructions.

4. Combine 6.x and 7.x license FEATURES. This allows migration of a given component to Genesys 7.x release while you are still running some 6.x components. Add 7.x licenses to the 6.x license file or vice versa.

See *Genesys Licensing Guide* for instructions on modifying license files.

5. Configure the new Genesys 7.x applications in Configuration Server.
See component sections of individual chapters of this guide to identify application-specific changes in licensing configuration.
6. Install Genesys 7.x application, pointing it to the new license server or the appropriate license file.
7. Stop License Server 6.x.

Note: The old license server should be stopped just before starting the new one. License Server 9.5 installation and component configuration should be done while the old license server is running. This would reduce the time during which the license server would be unavailable.

8. Start License Server 9.5.
9. Stop the Genesys 6.x application.
10. Start the Genesys 7.x application.
11. Monitor the Genesys 7.x application to ensure it is operating correctly.
12. Uninstall the Genesys 6.x application.

Upgrading Three-Server Redundancy

For three-server redundancy configuration, it is recommended to replace the old configuration by a new one.

It would also be possible to run both old and new three-server redundancy configurations in parallel (similar to the single server configuration described in “License Control Configurations” on [page 44](#)), but six computers would then be needed for the license servers.

Installing the new three-server redundancy configuration on the same computers as the old one has the least impact on old applications since this procedure avoids restarting them restart with new license information.

Note: The next procedure is based upon the assumption that you will be following these recommendations. If you decide to change the computers or run two three-server redundancy configurations in parallel, the migration steps should be changed to accommodate these modifications.

To Upgrade Three-Server Redundancy

1. Order new licenses from Genesys using information about the current license server hosts and generate a license file for all three license servers (see description of three-server redundancy, “License Control Configurations” on [page 44](#)).

Note: New licenses are only required for new or updated components. Unchanged components do not need new licenses. However, it is possible to issue a completely new license file for both unchanged and upgraded components.

2. Install License Server 9.5 on the same hosts as the previous three-server redundancy configuration, but in separate directories.

Note: Rollback to the old configuration would be easier if different directories were used.

3. Use the same hosts and port parameters as with License Server 6.x. See *Licensing Genesys Products* and *Genesys Licensing Guide* for installation instructions.
4. Combine Genesys 6.x and 7.x license FEATURES. This allows migration of a given component to Genesys release 7.x while you are still running some other Genesys 6.x components. Add 6.x licenses to the 7.x license file or vice versa.
See *Genesys Licensing Guide* for instructions on modifying license files.
5. Configure the new Genesys 7.x applications in Configuration Server.

See component sections of this guide to identify application-specific changes in licensing configuration.

6. Install Genesys 7.x application, pointing it to the new three-server redundancy license server and the appropriate license file.
7. Stop the individual license servers of the existing three-server redundancy configuration.

Note: The three-server redundancy servers should be stopped just before starting the new ones. License server installation and component configuration should be done while the old three-server redundancy is running. This would reduce the time during which license servers would be unavailable.

8. Start new License Server 9.5 on all three hosts.
9. Stop the Genesys 6.x application.
10. Start the Genesys 7.x application.
11. Monitor the Genesys 7.x application to make sure it is operating correctly.
12. Uninstall the Genesys 6.x application.

Upgrading Licensing System with Multiple Vendors

The customer may use FLEXlm to control not only Genesys products but other third-party products as well. In this situation, it is possible to have:

1. Separate license server instances for Genesys and for external products.
2. Same License Manager used to control both Genesys (vendor daemon and license file) and external products (each with its own vendor daemon and license file).

To Upgrade Single-Server Configuration with Multiple Vendors

Upgrade of a single-server configuration with multiple vendors can proceed as follows:

Note: Multiple vendor daemons on the same server machine are only possible if they are from a different vendor.

1. Repeat procedures as described on “Single-Server Configuration” on [page 44](#).
 - Request new Genesys license file.
 - Install and configure new Genesys 7.x application.

2. Upgrade FLEXlm to version 9.5, or such an upgrade may already have been performed: for example, a License Manager upgrade could have been previously required by the third-party software.

Note: Because of FLEXlm compatibility rules, Genesys software also works with newer versions of the License Manager.

3. Upgrade Genesys vendor daemon.

The Genesys installation automatically installs both FLEXlm 9.5 License Manager and the new Genesys vendor daemon in the selected target directory.

If your current FLEXlm License Manager is already 9.5 or higher, you should keep it. For this purpose, the License Manager installed by Genesys should be removed after installation, and, if necessary, the new Genesys vendor daemon and other installed files should be copied to the required directory.

Note: The third-party vendor daemon does not have to be upgraded.

See Figure 5 on [page 54](#) below for an example of this configuration.

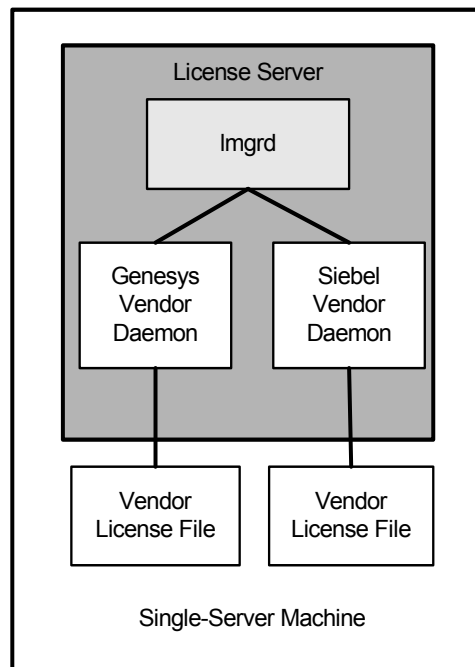

Figure 5: Single-Server Configuration with Multiple Vendors (example)

**To Upgrade
Multiple,
Independent-
Servers
Configuration with
Multiple Vendors**

Upgrade of a multiple, independent-servers configuration with multiple vendors can proceed as follows:

1. Repeat procedures described on “Multiple, Independent Servers Configuration” on [page 45](#).
 - Request new Genesys license file.
 - Install and configure new Genesys 7.x application.
2. Upgrade FLEXlm on one or more servers.

Upgrade FLEXlm to version 9.5 or such an upgrade may already have been performed: for example, a License Manager upgrade could have been previously required by the third-party software.

Note: Because of FLEXlm compatibility rules, Genesys software also works with newer versions of the License Manager.

3. Upgrade Genesys vendor daemon on one or more license servers.

The new Genesys installation automatically installs both FLEXlm 9.5 manager and the new Genesys vendor daemon in the selected target directory.

If your current FLEXlm License Manager is already 9.5 or higher you should keep it. For this purpose, the License Manager installed by Genesys should be removed after installation, and, if necessary, the new Genesys vendor daemon and other installed files should be copied to the required directory.

Note: The third-party vendor daemons on the license servers do not have to be upgraded.

See [Figure 6](#) below for an example of this configuration.

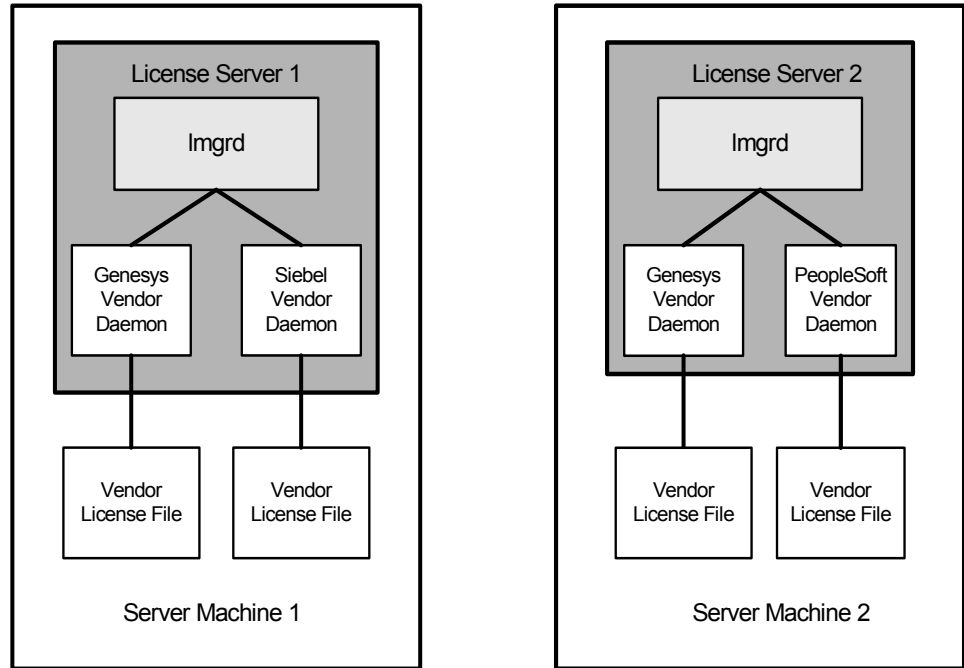

Figure 6: Multiple, Independent-Servers Configuration (example)



Part

2

Framework Migration

The chapters in this Part describe the migration process from releases 6.1, 6.5, 7.0, 7.1, 7.2, 7.5, 7.6 of Genesys Framework to release 8.0. They also discuss component changes and other Genesys software that support and enable Framework 8.0 functionality.

This Part covers the following:

- Migration order for the Genesys Framework, including the Configuration Database conversion.
- Interoperability information for Framework components.
- Migration instructions.

The information is divided into the following chapters:

- Chapter 3, “Introduction to Framework Migration,” on page 59 discusses the preliminary migration procedures and component compatibility. It provides an overview of the Framework migration process and of the Configuration Conversion Wizard (CCW) used for data conversion.
- Chapter 4, “Migration of Configuration Server Proxy 6.5,” on page 69 describes how to migrate your environment supported by Configuration Server Proxy 6.5 or 7.x to Configuration Server 8.0.x operating in Proxy mode. You should use these instructions *before* migrating your Configuration Database or upgrading other Framework components.
- Chapter 5, “Setup of Migration Environment,” on page 73 discusses the steps you should take prior to database conversion.
- Chapter 6, “Migration of Configuration Database,” on page 81 describes the Configuration Database conversion procedure for users of the 6.1, 6.5, or 7.x Configuration Database.
- Chapter 7, “Changes in Framework,” on page 89 describes major changes in Framework architecture and configuration option changes in each server component.
- Chapter 8, “Upgrade of Framework Components,” on page 115 describes how to upgrade applications that belong to the Genesys Framework, after you have successfully converted the configuration data.

- Chapter 9, “Migration of SNMP Option,” on page 125 describes how to migrate from your current SNMP (Simple Network Management Protocol) implementation to the built-in SNMP support in the 7.0 and later releases of the Management Layer.
- Chapter 11, “Load Distribution Server Migration,” on page 131 describes migration from release 6.5 or 7.0 to release 7.1 of Load Distribution Server (LDS), and configuration option changes in LDS release 7.0 and 7.1.
- Chapter 12, “Stat Server Migration,” on page 141 describes migration to release 7.x of Stat Server from prior releases beginning with release 6.5. It also discusses changes in Stat Server behavior and configuration.
- Chapter 13, “Integration Server and Software Development Kits Migration,” on page 159 explains how to upgrade from version 6.1, 6.5.0, 6.5.1, or 7.x to version 7.0, 7.1, 7.2, 7.5 or 7.6, of Genesys Integration Server (GIS) and related Software Development Kits (SDKs).

See the following appendices for further information:

- Appendix A, “Login Procedure,” on page 1189 describes a standard login procedure for a Genesys Framework GUI application.
- Appendix B, “Configuration Server Proxy Log Events Mapping,” on page 1191 enables you to determine correspondence between log events in Configuration Server Proxy 6.5 and Configuration Server 7.0 or later.

In addition, see the *Genesys Interoperability Guide*, which includes tables with interoperability information about 6.1, 6.5, 7.x, and some 8.0.x releases of Genesys products.



Chapter

3

Introduction to Framework Migration

This chapter discusses preliminary migration procedures and component compatibility, and gives an overview of the Framework migration process and the Configuration Conversion Wizard (CCW) used for data conversion.

This chapter contains the following topics:

- [Preliminary Migration Procedures, page 59](#)
- [Order of Migration for 8.0, page 61](#)
- [Interoperability Among Framework Components, page 62](#)
- [About CCW, page 67](#)

Preliminary Migration Procedures

Note: If you want to upgrade your operating system, you must do this before migrating your Genesys product.

The migration process includes these preliminary procedures for Framework 8.0:

1. Review Chapter 1, “Migration Roadmap,” in this guide.
2. Examine the order in which you must upgrade the Genesys software required for Framework 8.0. See “Order of Migration for 8.0” on [page 61](#).
3. Examine “Component Changes for Framework” on [page 89](#). You might also want to look at “Configuration Option Changes for Framework” on [page 99](#).

Note: The tables in Chapter 7 on [page 89](#) discuss only changes that directly affect the migration of this product. For complete information about what is new in this release of Framework and how the 8.0 release functions, see the *Framework 8.0 Deployment Guide*. For a complete list of documentation relevant to the migration of this product, see [“Reference Materials”](#).

4. Review the licensing requirements for Framework 8.0. See Chapter 2, “Licensing Migration,”.

Note: Beginning with release 7.0, you do not need a license to operate Stat Server. Stat Servers prior to release 7.0 did need a license.

5. Check the interoperability of the Framework 8.0 components during the upgrade procedures. See the *Genesys 7 Interoperability Guide* for more information.
6. Review the capabilities of the Configuration Conversion Wizard (CCW) on [page 67](#).
7. Review other issues pertaining to the migration of Framework to release 8.0. See “Additional Information about Migration” on [page 67](#).

Note: Starting with release 7.0, the Stat Server Application, Application Template, and Configuration Wizard are packaged separately from Framework. These components now reside on the Real-Time Metrics Engine DVD. See the chapter on “Stat Server Migration,” for more information.

Reference Materials

Consult these additional resources as necessary:

- *Framework 8.0 Deployment Guide*

For system-level information, consult the following guides, which are available on the Technical Support website:

- *Genesys 8.0 Security Deployment Guide*
- *Genesys Hardware Sizing Guide*
- *Genesys Interoperability Guide*
- *Genesys Licensing Guide*
- *Genesys Supported Media Interfaces Reference Manual*
- *Genesys Supported Operating Environment Manual*

Order of Migration for 8.0

This section discusses multi-site/single-site and multi-tenant migration, migration order, and laboratory testing and rollback.

Multi-Site/Single-Site and Multi-Tenant Migration

It is possible to migrate all sites or all tenants simultaneously. It is possible to migrate separate sites independently. There can also be interoperability of different versions at different sites.

The conversion procedures for a Multi-Tenant environment and an Enterprise (Single-Tenant) environment are the same.

Migration and Upgrade Order

Starting with release 6.0, the installation, configuration, and operation of Genesys software in a contact center are solution-based instead of component-based. This approach calls for:

- Common functionality that integrates components.
- Applications that perform solution-level management.
- An enhanced configuration data model that supports new functions and configuration objects.

Because of these changes, migration from previous releases must be performed gradually in two stages.

Warning! If you are using Configuration Server Proxy 6.5 to support your distributed configuration environment, you must convert every Configuration Server Proxy 6.5 in your environment before you convert the Configuration Database or upgrade any other Framework components. See [Chapter 4](#), for details.

Stage One

The first stage involves:

- Setting up DB Server 8.0 to access the existing and subsequently the new Configuration Databases.
- Converting Configuration Database structures to 8.0 format, using the available scripts to automate the process.
- Setting up Configuration Server 8.0 to handle the reformatted database.

The Framework Configuration Layer upgraded during this stage is fully backward compatible, and you can use it to run existing previous installations.

For a detailed description of the first migration stage, refer to:

- Chapter 5, “Setup of Migration Environment,” on [page 73](#).
- Chapter 6, “Migration of Configuration Database,” on [page 81](#).

Conversion Permissions

Migrating your database might involve such tasks as creating a table space, user, or database. To successfully perform a database migration, you must have database administrator (DBA) permissions or ask your DBA for help.

Warning! Contact your DBA before migrating your Configuration Database if your database administrator has added any additional columns to the database tables. Configuration Conversion Wizard does not migrate custom tables or columns that your DBA might have added to the Genesys Configuration Database.

Terminology

When discussing various databases in this and other Framework-related chapters, the term *existing database* refers to the Configuration Database you have been using in your previous Genesys environment.

Stage Two During the second stage you will deploy Framework 8.0 components. This does not affect your existing configuration. Existing 7.x installations can continue operating throughout the upgrade process and after the upgrade is completed. Chapter 8, “Upgrade of Framework Components,” on [page 115](#), describes this second stage.

Laboratory Testing and Rollback

Given the changes introduced in recent releases, Genesys strongly recommends that you test the new installation under laboratory conditions before using it in a production mode. To preserve the possibility of a rollback to the previous environment, do not remove existing components or their configuration in the Configuration Database from the environment until normal operation of the 8.0 installation is tested and verified in production mode.

For information on new functionality and architectural changes implemented in release 8.0, refer to the *Framework 8.0 Deployment Guide*.

Interoperability Among Framework Components

The term *interoperable* means that different versions of Genesys solutions, components, or options can work together compatibly during the migration process.

Interoperability of Genesys products can occur at two levels of migration:

Two levels of interoperability

- **Interoperability at the suite level** means combining different versions of solutions and options during the migration process.

Example: You can migrate to the Configuration and Management Layers of Framework 8.0 and continue using other 7.x components. See the *Genesys 7 Interoperability Guide* for information about suite-level interoperability.

- **Interoperability at the solution-specific level** means combining different versions of the components of a particular solution while upgrading them sequentially during the migration process.

The mixture of components may include executables, applications, routing strategies, scripts, and data that comprise a particular solution.

As you upgrade each of the components in sequence, you will need to know if each is backward-compatible with the other Framework components.

If you have several components to upgrade, determine if the first components you upgrade to release 8.0 will be backward compatible with the components that are not upgraded yet.

The following section provides the answer to this important question.

Compatibility Among Framework Components

Framework 8.0. includes these components, listed by layer:

Configuration Layer

- Configuration Server
- Configuration Database
- Configuration Manager

The Configuration Layer also uses DB Server, a Services Layer component, to access the Configuration Database.

In addition, the Configuration Layer includes a number of Genesys wizards. If you have used release 7.6 or earlier wizards, replace them with corresponding 8.0 wizards using regular uninstallation and installation procedures.

Management Layer

- Local Control Agent (LCA)
- Solution Control Server (SCS)
- Solution Control Interface (SCI)
- Message Server
- Log Database
- Genesys SNMP Master Agent (an optional component to interface the Management Layer with a third-party Network Management System or NMS)

The Management Layer also uses DB Server, a Services Layer component, to access the Log Database.

Starting in release 8.0, LCA also includes the Genesys Deployment Agent, which is used by Genesys Administrator (a new interface in Release 8.0) to deploy Genesys Applications and Solutions to the Host on which the LCA and the Genesys Deployment Agent are deployed.

In addition, the Management Layer includes a number of Genesys wizards. If you have used release 7.6 or earlier wizards, replace them with corresponding 8.0 wizards using regular uninstallation and installation procedures.

User Interaction Layer

- Genesys Administrator

Genesys Administrator is a new component in release 8.0. It is a web-based interface that combines most of the functionality of Configuration Manager and Solution Control Interface.

Media Layer

- T-Server
- HA Proxy
- Load Distribution Server

Refer to the chapter “T-Server Migration Procedures,” for information about migrating T-Server and HA Proxy.

Services Layer

- DB Server
- Stat Server

Refer to the chapter “Stat Server Migration,” for information about migrating Stat Server.

Configuration Layer Components Compatibility

Configuration Server 8.0

Configuration Server 8.0 operates with these versions of the other Framework components:

- DB Server releases 8.0, 7.6, 7.5, 7.2, 7.1, 7.0, 6.5, and 6.1
- Configuration Manager release 8.0
- Local Control Agent releases 8.0, 7.6, 7.5, 7.1, 7.0, 6.5, and 6.1
- Solution Control Server releases 8.0, 7.6, 7.5, 7.1, 7.0, 6.5, and 6.1
- Message Server releases 8.0, 7.6, 7.5, 7.1, 7.0, 6.5, and 6.1
- Genesys Administrator release 8.0
- T-Server releases 8.0, 7.6, 7.5, 7.2, 7.1, 7.0, 6.5, and 6.1
- HA Proxy releases 8.0, 7.6, 7.5, 7.2, 7.1, 7.0, 6.5, and 6.1
- LDS releases 7.2, 7.1, 7.0 and 6.5
- Stat Server releases 8.0, 7.6, 7.5, 7.2, 7.1, 7.0, 6.5, and 6.1

Warning! Configuration Server Proxy 6.5 does not work with Configuration Server 7.x or 8.0. However, Configuration Server 7.x and 8.0 in Proxy mode works with Configuration Server 6.5. If you use Configuration Server Proxy 6.5, you must first convert all Configuration Server Proxies 6.5 to Configuration Server 7.0 or later operating in Proxy Mode. See Chapter 4 on [page 69](#) for instructions.

Notes:

- To ensure faultless operation, all Configuration Servers in the environment must be running the same release. The only exception to this is during the migration process, when different Configuration Servers can be temporarily running different releases before being upgraded.
 - Starting in release 7.5, Configuration Server does not support backward compatibility of Keep-Alive Protocol (KPL) for release 6.5 clients. If you used KPL with previous Genesys versions, consider using Automatic Disconnect Detection Protocol (ADDP) after you upgrade to release 8.0. Refer to the *Framework 8.0 Deployment Guide* for information about ADDP.
-

Configuration Manager 8.0

Configuration Manager 8.0 operates with these versions of the other Framework components:

- Configuration Server release 8.0 only

Management Layer Components Compatibility

Local Control Agent 8.0

LCA 8.0 operates with 8.x, 7.x, and 6.x versions of any other Framework server components.

Solution Control Server 8.0

SCS 8.0 operates with these versions of the other Framework components:

- Local Control Agent releases 8.0, 7.6, 7.5, 7.1, 7.0, 6.5, and 6.1
- Solution Control Interface releases 8.0, 7.6, 7.5, 7.1, 7.0, 6.5, and 6.1
- Message Server releases 8.0, 7.6, 7.5, 7.1, 7.0, 6.5, and 6.1
- Genesys SNMP Master Agent releases 8.0, 7.6, 7.5, 7.1, 7.0 and 6.5
- Configuration Server releases 8.0, 7.6, 7.5, 7.2, 7.1, 7.0, 6.5, and 6.1
- Genesys Administrator release 8.0

Solution Control Interface 8.0

SCI 8.0 operates with these versions of the other Framework components:

- Configuration Server releases 8.0, 7.6, 7.5, 7.2, 7.1, 7.0, 6.5, and 6.1
- Solution Control Server releases 8.0, 7.6, 7.5, 7.1, 7.0, 6.5, and 6.1
- Message Server releases 8.0, 7.6, 7.5, 7.1, 7.0, 6.5, and 6.1

- DB Server releases 8.0, 7.6, 7.5, 7.2, 7.1, 7.0, 6.5, and 6.1

**Message Server
8.0**

Message Server 8.0 operates with these versions of the other Framework components:

- DB Server releases 8.0, 7.6, 7.5, 7.2, 7.1, 7.0, 6.5, and 6.1
- Local Control Agent releases 8.0, 7.6, 7.5, 7.1, 7.0, 6.5, and 6.1
- Solution Control Server releases 8.0, 7.6, 7.5, 7.1, 7.0, 6.5, and 6.1
- Log Database 8.0, 7.6, 7.5, 7.1, 7.0, 6.5, and 6.1
- T-Server releases 8.0, 7.6, 7.5, 7.2, 7.1, 7.0, 6.5, and 6.1
- HA Proxy releases 8.0, 7.6, 7.5, 7.2, 7.1, 7.0, 6.5, and 6.1
- LDS releases 7.2, 7.1, 7.0 and 6.5
- Stat Server releases 8.0, 7.6, 7.5, 7.2, 7.1, 7.0, 6.5, and 6.1
- Genesys SNMP Master Agent releases 8.0, 7.6, 7.5, 7.1, 7.0, and 6.5
- Configuration Server releases 8.0, 7.6, 7.5, 7.2, 7.1, 7.0, 6.5, and 6.1

**SNMP Master
Agent 8.0**

Genesys SNMP Master Agent 8.0 operates with these versions of the other Framework components:

- Local Control Agent releases 8.0, 7.6, 7.5, 7.1, 7.0, 6.5, and 6.1
- Solution Control Server releases 8.0, 7.6, 7.5, 7.1, 7.0 and latest 6.5
- Message Server releases 8.0, 7.6, 7.5, 7.1, 7.0, 6.5, and 6.1
- Configuration Server releases 8.0, 7.6, 7.5, 7.2, 7.1, 7.0, 6.5, and 6.1

User Interface Layer Components Compatibility

**Genesys
Administrator 8.0**

Genesys Administrator 8.0 operates with these versions of the other Framework components:

- Configuration Server release 8.0 only
- Solution Control Server release 8.0 only

Media Layer Components Compatibility

Refer to the T-Server Part of this guide for information on T-Server and HA Proxy.

Services Layer Components Compatibility

DB Server 8.0

DB Server 8.0 operates with these versions of the other Framework components:

- Configuration Server releases 8.0, 7.6, 7.5, 7.2, 7.1, 7.0, 6.5, and 6.1
- Local Control Agent releases 8.0, 7.6, 7.5, 7.1, 7.0, 6.5, and 6.1
- Message Server releases 8.0, 7.6, 7.5, 7.1, 7.0, 6.5, and 6.1

- Stat Server releases 8.0, 7.6, 7.5, 7.2, 7.1, 7.0, 6.5, and 6.1
- Solution Control Interface releases 8.0, 7.6, 7.5, 7.1, 7.0, 6.5, and 6.1

Stat Server 7.x Refer to the chapter “Stat Server Migration,” for information about Stat Server.

Additional Information about Migration

The following information also pertains to the migration of Framework to release 8.0.

- If you have a distributed configuration environment supported by Configuration Server Proxy release 6.5, you must upgrade all Configuration Server Proxies 6.5 to Configuration Server 7.0 or later before you start any migration. See Chapter 4 on [page 69](#) for more information.
- Review suite-level migration issues. The section on Stat Server changes in the Stat Server chapter of this guide, for instance, lists some algorithm changes in Stat Server that affect statistical values sent to clients.

Note: For an overview of migration issues, please see Chapter 1, “Migration Roadmap,” of this guide.

About CCW

To make the existing Configuration Database compatible with Configuration Server 8.0, you must convert the structures of the database to 8.0 format.

Use the Genesys Configuration Conversion Wizard (CCW) to convert existing data structures to the 8.0 format. The Configuration Conversion Wizard (CCW) performs automatic migration from any release to release 8.0.

CCW only converts the database structures originally created with the Genesys initialization scripts. CCW does *not* convert any custom tables or columns that you might have added to the Configuration Database.

Note: Starting with release 7.0, CCW does not convert data from SCE (Service Creation Environment) databases used with Genesys release 5.0. You need to migrate data to Configuration Database 6.5 using CCW 6.5 and then to Configuration Database 8.0 using CCW 8.0.

After the conversion, CCW generates a detailed report of conversion statistics, including database changes, for your review. The same information is stored in a log file that CCW creates for each working session.

CCW can also help you:

- Update localization information in the Configuration Database by executing localization scripts.

Note: During the execution of localization scripts, a copy of the configuration data is updated while the original configuration data stays intact. The procedure is similar to the migration from releases 6.1, 6.5, 7.0, 7.1, 7.2, and 7.6; it is designed to protect data from corruption and minimize Configuration Server downtime. The production database remains operational during the update procedure.

- Export data from your Genesys Configuration Database into a text file.

Note: CCW only exports data from the database structures originally created with the Genesys initialization scripts.

- Import the data, which you have previously exported with CCW, into an initialized, empty Genesys Configuration Database. Both databases—the one from which the data was exported and the one into which the data is being imported—must be initialized using the initialization scripts from Configuration Servers of the same release. The target database, the one into which you are importing data, must be empty.
- Check the business logic of data in your Genesys Configuration Database. The business logic rules imply certain patterns in associations between configuration objects in addition to the Configuration Server integrity rules. For example, a report on business logic verification might indicate which Places have no DNs assigned to them, which Agents have no Logins assigned to them, and so on.

You might find these functions useful when you prepare your release 7.6 or earlier database for migration, or when you work with your 8.0 database.



Chapter

4

Migration of Configuration Server Proxy 6.5

This chapter describes how to migrate a Configuration Server Proxy 6.5 to Configuration Server 7.0 or later operating in Proxy mode. Use the instructions in this chapter *before* migrating your Configuration Database or upgrading other Framework components.

This chapter contains the following topics:

- [Preliminary Migration Instructions, page 69](#)
- [Upgrading from 6.5, page 70](#)
- [Next Steps, page 71](#)

Preliminary Migration Instructions

In release 6.5, Genesys provided support for geographically distributed environments with the use of Configuration Server Proxy 6.5. Starting with release 7.0, the same functionality is implemented in Configuration Server and is available when Configuration Server is installed in Proxy mode; Configuration Server Proxy as a separate component is no longer supported. Also, Configuration Server Proxy 6.5 *cannot* operate with Configuration Database release 7.0 or higher.

For this reason, you must first replace instances of Configuration Server Proxy 6.5 with instances of Configuration Server 7.x or 8.0 operating in Proxy mode. Only after doing this can you migrate your Configuration Database and upgrade the rest of Framework components.

Terminology

For the purpose of this discussion, Configuration Server 8.0 that operates in Proxy mode and provides similar functionality as Configuration Server Proxy 6.5 is called *Configuration Server Proxy 8.0*.

Licensing Requirements

Configuration Server capability to run in Proxy mode is controlled by the Genesys licensing system. Refer to Chapter 2, “Licensing Migration,” in this guide for instructions on how to update your licenses.

Note: Beginning with release 7.0.1, customers need a high-availability (HA) license to use any Genesys servers in redundant configurations (which include a standby). The license feature name is `ha_redundancy`, and the Solution Control Server (SCS) controls this license. If the license is unavailable, SCS cannot perform a switchover between primary and backup servers when the primary fails.

However, there is a workaround. Even without the HA license, SCS can perform a switchover if:

- You use SCI to shut down the primary application.
 - You use SCI to trigger a manual switchover.
-

Upgrading from 6.5

A geographically distributed environment in release 6.5 included one Configuration Server (or a redundant pair of primary-backup Configuration Servers) and one or more instances of Configuration Server Proxy. In order to upgrade your environment to release 8.0, replace all instances of Configuration Server Proxy 6.5 with instances of 8.0.

Upgrade Instructions

The following information summarizes the Configuration Server Proxy migration from release 6.5 to 8.0.

To Replace All Instances of Configuration Server Proxy 6.5

1. Configure and install Configuration Server Proxy 8.0. See the *Framework 8.0 Deployment Guide* for instructions on deploying Configuration Server 8.0 in Proxy mode.
2. Shut down Configuration Server Proxy 6.5.
3. Start Configuration Server Proxy 8.0.
4. Reconnect clients of Configuration Server Proxy 6.5 to the corresponding Configuration Server Proxy 8.0.
5. If you had any Alarm Conditions configured for Configuration Server Proxy 6.5 log events, reconfigure them to point to corresponding 8.0 log events. See Appendix B, “Configuration Server Proxy Log Events Mapping” on [page 1191](#) for log event mapping information.

Rollback Instructions

If returning to your 6.5 installation, follow these steps for each instance of Configuration Server Proxy 8.0:

- To Roll Back**
1. Shut down Configuration Server Proxy 8.0.
 2. Start Configuration Server Proxy 6.5.
 3. Reconnect clients to Configuration Server Proxy 6.5.
 4. Uninstall Configuration Server Proxy 8.0.
 5. Remove the Configuration Server Proxy 8.0 Application object from the Configuration Database.
 6. Reverse the Alarm Conditions configuration to use Configuration Server Proxy 6.5 log events.

Next Steps

After you replaced instances of Configuration Server Proxy 6.5 with Configuration Server Proxy 8.0:

- If you have not reviewed the Framework migration order and interoperability information in Chapter 3 on [page 59](#), return to that chapter. After that, you can proceed with setting up your migration environment as described in Chapter 5 on [page 73](#).
- If you have already read through Chapter 3 on [page 59](#), proceed with setting up your migration environment as described in Chapter 5 on [page 73](#).



Chapter

5

Setup of Migration Environment

This chapter discusses the steps you must take prior to database conversion.

This chapter contains the following topics:

- [Calculating the New Database Size, page 73](#)
- [Checking Configuration Data, page 73](#)
- [Installing the Configuration Layer, page 75](#)
- [Installing the Configuration Conversion Wizard, page 76](#)
- [Specifying the Database Connection, page 76](#)
- [Using Password-Encryption, page 80](#)

Calculating the New Database Size

Check the size of the existing database and calculate the size of the new database. A database dedicated to the 7.x Configuration Layer must be at least 25 percent (or 1.25 times) larger than a 6.x database.

If data storage capacity is limited, allocating 10 KB of space for every object in the contact center is a general guideline. Places, DNs, and Agents usually account for the majority of configuration objects.

For information on extending a database, refer to database management manuals or contact your database administrator.

Checking Configuration Data

For the database migration to be successful, your existing data must be accurate. Some data integrity rules have changed since earlier releases, and Configuration Conversion Wizard uses the latest rules. When converting your

data to the 8.0 database, CCW might encounter instances of configuration that do not comply with the 8.0 rules, and it will inform you of these instances.

Primary and Backup Servers

Most often, this applies to the configurations of primary and backup servers. In an 8.0 configuration, primary and backup servers:

1. Must be primary-backup pairs. That is, no backup servers can be configured for a server that is configured to be a backup server itself.
2. Must have one-direction references. That is, a backup server must not have a reference to its primary server in its Backup Server field.

Migrating a Changed Database Structure

Note the following issues about the use of CCW for converting the Configuration Database (and its importing and exporting procedures):

- Any modifications to the Configuration Database structure that you make directly in the database engine are considered to be foreign (custom-added). Foreign fields and tables are not migrated, and data from them is not exported.
- CCW does not transfer foreign tables (such as those used to record a state of the Configuration Database) during migration.
- Obsolete fields and tables of the original Configuration Database are removed during conversion after CCW migrates the data they contain. (Using a non-CCW import-export procedure does not prevent this removal.)

Note: CCW applies these rules to migration of release 7.6 or earlier to 8.0.

Database Structure Modification Discovery

Migrating with CCW brings with it a database structure modification discovery procedure. This procedure detects:

- Foreign fields in Configuration Database tables
- Foreign tables
- Obsolete fields in Configuration Database tables and obsolete tables

The CCW discovery procedure generates a detailed report that is available for viewing from the Configuration Database Information pane. Clicking the button to the right of the Database Structure line on the pane opens a window that contains information about what the Configuration Database Structure wizard is currently connected to.

- If the discovery procedure does not find any changes to the database structure, the button's label reads `Original`. Clicking it reveals information about the original structure of the database.

- If the discovery process finds changes, the button's label reads `Modified` (and a warning sign icon appears next to the button). Clicking it reveals information about the modified structure of the database.
- If the discovery process, for any reason, is unable to determine whether there were any changes to the database structure, the button's caption reads `Unknown`.

The detailed report from the discovery process lists tables in the database, rows in tables, and fields of tables (with their data types, lengths, and whether nulls are allowed).

Changes to Enumerators—Now Business Attributes

Beginning with release 7.0.1 of the Configuration Layer, Business Attributes is the new name for Enumerators, and Attribute Values is the new name for Enumerator Values. In addition to the name change, Genesys has added new predefined Business Attributes.

During migration from a release prior to 7.0.1, and for each predefined Business Attribute being installed with the 8.0 release, if there already exists a user-defined Business Attribute with the same name, the system renames the existing Business Attribute and adds the new predefined Business Attribute in its place. With multi-tenant databases, for each sub tenant, the system copies the predefined Business Attributes from the super tenant. If there arise name conflicts, the system renames the user-defined Business Attribute and adds the predefined one to its place.

Note: This resolution to name conflicts found during migration may affect applications that rely on the attributes of the user-defined objects.

Installing the Configuration Layer

Note: Configuration Server 8.0 consumes 2.5 times more memory than Configuration Server 6.x (but not more than other 7.x versions). Allocate at least 1 GB of virtual memory to Configuration Server 8.0 and adjust RAM as needed after you monitor Configuration Server 8.0 operations.

To Set Up Components of the Configuration Layer

To set up the components of the 8.0 Configuration Layer that are required for the migration procedure, you must:

1. Install DB Server 8.0 and configure it to work with the existing database.
2. Install Configuration Server 8.0.

Warning! Do not execute the database initialization scripts at this point.

3. Install Configuration Manager 8.0.

For installation and configuration instructions for the Configuration Layer components, refer to the *Framework 8.0 Deployment Guide*.

Installing the Configuration Conversion Wizard

Note: If you have installed Configuration Conversion Wizard (CCW) for any release prior to 8.0, uninstall it before installing CCW release 8.0.

- To Install CCW:**
1. Locate the installation package on the Management Framework 8.0 product DVD in the `configuration_layer/convers_wizard/windows` directory.
 2. Locate and double-click `Setup.exe` to start installation.
 3. Specify the program folder to which you want to add CCW. By default, it is added to the `Genesys Solutions/Framework` folder.
 4. When the CCW icons appear, click `Finish` to complete the installation.

When the setup program is finished, Configuration Conversion Wizard is ready to start; however, to operate, CCW requires that you specify connection parameters.

Specifying the Database Connection

To connect to your existing Configuration Database, CCW requires information about that database and the DB Server through which the database is to be accessed. You provide this information in one of two ways:

- As configuration option values within the database connection configuration file named `convers.cfg`. See “Configuring the Local Configuration File” on [page 76](#) for instructions.
- As values entered interactively during startup. See “Entering Connection Parameters Dynamically” on [page 79](#) for instructions.

Configuring the Local Configuration File

To Create a File Listing Database Connection Parameters

1. Open the local configuration file (`convers.cfg`) in the directory where CCW is installed.

2. Within this file, specify the values for the configuration options described in “[Configuration Options Description](#)”, below. For configuration option values, use information about DB Server 8.0, the existing Configuration Database, and the DBMS user account through which the database is currently accessed. (See “Sample Configuration File” on [page 79](#) for an example of a database connection configuration file.)

Warning! Do not use the Tab key for entries in the configuration file.

3. Save the configuration file.

Configuration Options Description

Specify values for the following options to provide the Configuration Conversion Wizard with information about the Configuration Database, and about the DB Server through which CCW must access this database.

Note: If you are changing the connection parameters after initial installation, you must save the configuration file and re-specify it in the Connection to the Configuration Layer Database screen of CCW.

host

Default Value: No default value

Valid Value: Any valid host name

Changes Take Effect: After configuration file is specified in CCW

Specifies the host name of the computer running the DB Server 8.0 through which the Configuration Database is to be accessed.

port

Default Value: No default value

Valid Value: Any valid TCP/IP port

Changes Take Effect: After configuration file is specified in CCW

Specifies the TCP/IP port that clients should use to connect to the DB Server 8.0 through which the Configuration Database is to be accessed.

dbengine

Default Value: No default value

Valid Values: oracle, sybase, informix, mssql, db2

Changes Take Effect: After configuration file is specified in CCW

Specifies the type of DBMS that handles the Configuration Database.

dbname

Default Value: No default value

Valid Value: Any database name

Changes Take Effect: After configuration file is specified in CCW

Specifies the name of the Configuration Database to be accessed as specified in the DBMS that handles this database. A value for this option must be specified unless `dbengine=oracle`.

dbserver

Default Value: No default value

Valid Value: Any valid entry name

Changes Take Effect: After configuration file is specified in CCW

Specifies the name or alias identifying the DBMS that handles the Configuration Database.

dbtimeout

Default Value: No default value

Valid Value: Any positive integer

Changes Take Effect: After configuration file is specified in CCW

Specifies the maximum time, in seconds, before which CCW should cease attempting to make its initial connection to the Genesys Database Server.

dbrequest-timeout

Default Value: 30

Valid Value: 1 - 3000

Changes Take Effect: After configuration file is specified in CCW

Specifies the maximum time, in seconds, in which the database request should be completed. If the request does not complete in this time, the request is cancelled, the import procedure is aborted, and a corresponding message is displayed to the user.

username

Default Value: No default value

Valid Value: Any character string

Changes Take Effect: After configuration file is specified in CCW

Specifies the user name established in the DBMS to access the Configuration Database.

password

Default Value: No default value

Valid Value: Any character string

Changes Take Effect: After configuration file is specified in CCW

Specifies the password established in the DBMS to access the Configuration Database.

delete-in-size

Default Value: 200

Valid Value: 1 - 32767

Changes Take Effect: After configuration file is specified in CCW

Specified only when migrating from release 6.5; specifies the number of fields in an SQL query that uses the IN statement, such as:

```
DELETE... FROM ... WHERE ... IN (X1, ..., An)
```

where n = value of delete-in-size.

Use this option to limit the length of SQL queries that use the IN statement.

Sample Configuration File

```
host = db-host
port = 4040
dbengine = mssql
dbserver = server_name
dbname = config
username = DBMS_user
password = DBMS_user_password
```

Entering Connection Parameters Dynamically

If you do not configure a configuration file with the connection parameters, CCW prompts you to enter the parameters during startup.

To provide Configuration Conversion Wizard with information about the Configuration Database and about the DB Server through which CCW must access this database, the following parameters are required:

To Provide CCW with Parameters

1. The host name of the computer running the DB Server 8.0 that provides access to the Configuration Database.
2. The TCP/IP port that clients should use to connect to the DB Server 8.0 through which the Configuration Database is to be accessed.
3. The type of DBMS (engine) that handles the Configuration Database.
4. The name or alias identifying the DBMS that handles the Configuration Database.
5. The name of the Configuration Database to be accessed as specified in the DBMS that handles this database.
6. The user name established in the DBMS to access the Configuration Database.
7. The password established in the DBMS to access the Configuration Database.

Using Password-Encryption

Starting with release 7.0, CCW can encrypt the password you use for accessing the Configuration Database so that it does not explicitly appear in the CCW configuration file or log. This improves configuration data security.

To enable access password encryption, start CCW with the following command line:

```
ConversWizard.exe -p <config-file-name>.cfg <password value>
```

Where

-p The command-line parameter that forces an instance of CCW to start, encrypt the database password in the configuration file, and terminate.

<config-file-name>.cfg

The name of the CCW configuration file (usually, `convers.cfg`) that describes parameters of the Configuration Database whose access password is being encrypted.

password value

The password used for accessing the specified Configuration Database.

As a result of this command, CCW writes an encrypted password in the configuration file and exits.



Chapter

6

Migration of Configuration Database

This chapter describes the Configuration Database conversion procedure for users with a Configuration Database of release 7.6 or earlier. It contains the following topics:

- [About Migration from Previous Releases, page 81](#)
- [Migration Instructions, page 82](#)

About Migration from Previous Releases

During migration from an earlier release, a copy of the configuration data is converted to 8.0 format while the original configuration data stays intact. The procedure is designed to protect data from corruption, and to minimize Configuration Server downtime. As a result, the production database remains operational during the conversion procedure and after the conversion is finished, and existing applications can connect to Configuration Server 8.0 and, thus, to the converted database. See “Migrating a Changed Database Structure” on [page 74](#) for information on how the migration process deals with changes you may have made to your existing Configuration Database structure.

Warning! Configuration Server release 7.6 or earlier is switched to Read-only mode during the data conversion; this ensures that Configuration Server clients do not modify existing data while it is being converted. Configuration Server returns to normal operational mode after the conversion procedure is complete.

To switch Configuration Server to Read-only mode, you must supply the login parameters of the Master Account. If you do not have the account information, ask the administrator for your Genesys Configuration Database for help. For more information on the Master Account and Read-only mode, see the *Framework 8.0 Deployment Guide* and *Framework 8.0 Configuration Manager Help*.

To upgrade the existing database, first set up the migration environment as described in [Chapter 5](#). Then proceed with the database conversion as described in the following section.

Note: The conversion procedure for Configuration Database 5.1 is similar to the current procedure for Configuration Database. Note, however, that the Configuration Conversion Wizard (CCW) does not convert 5.1 data from DB2 databases.

Migration Instructions

Follow the procedures described in this section to migrate your data from a release 7.6 or earlier database.

Starting Applications for Conversion

To begin upgrading configuration data structures to the 8.0 format, do the following:

1. Make sure that your release 7.6 or earlier Configuration Server is running properly.
2. Start DB Server 8.0 (refer to the *Framework 8.0 Deployment Guide*).

Next, start the Configuration Conversion Wizard (CCW):

- To Start CCW**
1. Make sure that you have the database connection parameters (see “Specifying the Database Connection” on [page 76](#)).
 2. From the Windows’ Start menu > Programs menu, run Configuration Conversion Wizard (CCW).
 3. Read the CCW Welcome page and make sure that the listed preliminary requirements are met.

4. Provide the database connection parameters, by doing one of the following:
 - Select `Use configuration file` and provide the name and location of the configuration file (see “Configuring the Local Configuration File” on [page 76](#)).
 - Select `Manually enter parameters` and enter the parameters as requested on the subsequent wizard pages (see “Entering Connection Parameters Dynamically” on [page 79](#)).

When CCW connects to the database with the specified parameters, it:

- Identifies the version of the database to which it has connected.
- Checks the content of configuration data in the database.
- Gathers some statistical information about the database.
- Verifies whether Configuration Server runs against the database. If so, CCW prompts the user for Configuration Server connection parameters and sets Configuration Server to Read-only mode.

For instructions on what values to specify for Configuration Server connection parameters, see Appendix A, “Login Procedure” on [page 1189](#). Use the user name and password of the Master Account; no other account has permissions to switch Configuration Server to Read-only mode.

Converting Configuration Data

When CCW is ready to operate with the database, proceed with the upgrade procedures:

To Convert the Configuration Database

1. From the list of possible procedures that CCW displays, select `Upgrade Configuration Database`.
2. When CCW prompts you to specify a new database that is to be used for the conversion procedure:
 - a. Go to the database management system (DBMS) that handles your existing Configuration Database and do one of the following:
 - For all DBMS types except Oracle, create a new database, which will be used as the database copy for conversion.

Note: The existing and new databases must be located within the same DBMS. Use the same user account to access both databases.

If you are using Sybase, see also “Recommendations for Sybase Users” on [page 85](#).

- For the Oracle DBMS, create a new user.

- b. Using DBMS tools, copy the existing Configuration Database into the newly created database.

Note: If you are using MS SQL, Genesys recommends that you use the DBMS backup and restore procedures for copying the database.

- c. Return to the CCW window.
3. Specify the name of the newly created database (for all DBMS types except Oracle) or the new user name and password (for the Oracle DBMS).
4. Click Next to start the data conversion.

The conversion process might take some time, depending on the database size. A progress bar appears during conversion, indicating the progress of the conversion process.

For example, conversion of a Configuration Database that contains around 200,000 configuration objects takes approximately 15 minutes if you use a computer running Windows 2000 with 1.5 GHz and 1 GB RAM.

If CCW detects that data in a particular table within your database does not comply with the 8.0 integrity rules, a warning is displayed. If this warning appears, exit CCW, resolve the data inconsistency as described on [page 87](#), and restart the conversion process.

5. When CCW prompts you for which localization script to execute:
 - To load the English localization data from the Wizard's internal source, select `Load default English localization data`.
 - To load localization data from an external source, select `Load specific localization script which I will point out`. Then browse for the script that loads the `CfgLocale` table into the converted database. A script for your database type is located in the `sql_scripts` folder within the directory where Configuration Server 7.6 is installed.

[Table 1](#) provides a list of database types and their corresponding localization script names for an enterprise or multi-tenant environment.

Table 1: CfgLocale Scripts

Database Type	Script Name
DB2	CfgLocale_db2.sql
Informix	CfgLocale_ifx.sql
Microsoft SQL	CfgLocale_mssql.sql
Oracle	CfgLocale_ora.sql
Sybase	CfgLocale_syb.sql

After executing the script, CCW checks the existing Switching Office objects to find out if any are of these types:

- WorldCom 800 Gateway
- AT&T 800 ICP Gateway
- Concert 800 Gateway

This verification occurs because in the 8.0 Configuration Database, a clear distinction is made among different switches of the general WorldCom 800 type. If you use AT&T 800 ICP Gateway or Concert 800 Gateway switches in your environment, you must update the corresponding Switching Office objects to reflect the actual type so that T-Servers for these switches can operate.

If the database contains one or more Switching Office objects of one of the three types, CCW displays the list of these Switching Office objects and suggests that you specify one of the three types for each Switching Office in the list:

- WorldCom 800 Gateway (the default choice)
 - AT&T 800 ICP Gateway
 - Concert 800 Gateway
6. For each existing Switching Office, select the type that matches your environment.
 7. When a message appears indicating that the database upgrade is complete:
 - a. Click **Statistics** to review a report on how many objects in each database table have been removed, added, or converted.
 - b. Click **Finish** to exit CCW.

CCW stores information about the conversion in a log file created in the Log folder within the directory in which CCW is installed.

At shutdown, CCW sets the release 7.6 or earlier Configuration Server back to the normal operational mode.

Recommendations for Sybase Users

To migrate the Configuration Database that resides in the Sybase DBMS, the option `select into` must be set to `true` for the new database (the copy that is being converted). You can do this within the `isql` shell using the following command sequence:

```
master..sp_dboption <your_db_name>, 'select into', true
go
use <your_db_name>
checkpoint
go
```

Starting the 8.0 Environment

The conversion procedure places the converted data in the newly created database. Use this database as your 8.0 Configuration Database.

To Start the New 8.0 Environment

After you exit the Configuration Conversion Wizard:

1. Ensure that a configuration file for Configuration Server 8.0 exists in the directory where Configuration Server 8.0 is installed. This file must provide the Configuration Server with the configuration information about the Configuration Database that has been created as a result of the conversion procedure, about the user account through which the database can be accessed, and about DB Server 8.0.
2. Start Configuration Server 8.0.
3. Start Configuration Manager 8.0. Then, in the **Login** window, specify the connection parameters of Configuration Server 7.6 (see Appendix A, “Login Procedure” on [page 1189](#)).
4. Check the Configuration Server 8.0 log to verify that Configuration Server is running correctly.
5. Stop Configuration Server 8.0.
6. In the configuration file for Configuration Server 8.0, set the host and port options equal to the values specified in the configuration file for the release 7.6 or earlier Configuration Server.

Note: Starting in release 7.5, the port option in the configuration file is used only during the first start of Configuration Server with an initialized database. After Configuration Server has started, the value of this option is written to the Configuration Database and associated with the Configuration Server Application object. Then, upon subsequent restarts, Configuration Server reads the port information from its Application object in the Configuration Database and ignores the setting of the port option in the configuration file.

Since the migrated Configuration Database already contains a Configuration Server Application object, Configuration Server uses the port specified in the database and not the port specified in its configuration file.

This step ensures that port information is synchronized between the Configuration Server configuration file and the Configuration Database.

7. Save the configuration file.
8. Stop the release 7.6 or earlier Configuration Server.

9. Start Configuration Server 8.0.

Resolving Data Inconsistency

During conversion, CCW might encounter instances of configuration that do not comply with the 8.0 rules. In this case, a warning displays requesting that you resolve the data inconsistency in a particular database table. If this warning appears:

To Resolve Data Inconsistency

1. Click **OK** to close the warning window and click **Finish** to exit CCW.
2. Check the CCW log file to identify the names of `Application` objects whose data do not comply with the 8.0 rules.
3. Make a backup copy of the existing database before you make any changes to the objects that CCW reported as inconsistent. This way, you can always restore your original database.
4. Start Configuration Manager and specify parameters of the Configuration Server that runs against the existing database at the Login Window (see Appendix A, “Login Procedure” on [page 1189](#)).
5. Decide which server(s) you want to leave as primary server(s) and which as backup server(s) so that:
 - All primary and backup servers are primary-backup pairs. That is, no backup servers are configured for a server that is configured to be a backup server itself.
 - All primary and backup servers have one-direction references. That is, no backup server has a reference to its primary server in the `Backup Server` field.
6. For those `Application` objects that you decided to leave as backup servers, set the `Backup Server` parameter to `none`.

After you resolve all instances of data inconsistency in your Configuration Database:

- Exit Configuration Manager.
- Restart the conversion process, beginning with “To Start CCW” on [page 82](#).



Chapter

7

Changes in Framework

This chapter describes major changes in Framework architecture and configuration option changes in each server component and discusses the following topics:

- [Component Changes for Framework, page 89](#)
- [Configuration Option Changes for Framework, page 99](#)

Component Changes for Framework

Table 2 on [page 89](#) lists summaries of all high-level component differences for Framework from release 6.0 through 8.0, with the most recent changes listed first. For detailed information about all new features and functions available in Framework 8.0, refer to the *Framework 8.0 Deployment Guide*.

Note: Starting with release 7.2, Stat Server information is provided in the chapter “Stat Server Migration”.

Table 2: Framework Component Changes Between Release 6.0 and 8.0

Current Component Name	Type of Change	Change Occurred in Release	Details
Configuration Database	Extended functionality	8.0	GVP objects are now stored in the Configuration Database. You can manage them using Genesys Administrator, or with Configuration Manager and Solution Control Interface.
DB Server	New functionality	8.0	DB Server can now detect database failures and try to reconnect.

Table 2: Framework Component Changes Between Release 6.0 and 8.0 (Continued)

Current Component Name	Type of Change	Change Occurred in Release	Details
Configuration Server	Extended functionality	8.0	You can now configure hierarchical multi-tenant environments, where each Tenant is a parent Tenant, child Tenant, or both.
	New functionality	8.0	All Management Framework clients of Configuration Server now subscribe for only necessary notifications, improving system performance.
Configuration Manager	New configuration object	8.0	You can now configure GVP Voice Platform Profiles in Configuration Manager.
	New functionality	8.0	By selecting an object in a Search results list, you can now directly open the folder containing that object, or view its list of dependent objects. You can set Configuration Manager to Emergency Mode, which provides read-only access to all Users except members of the Super Administrators access group. The on-line Help file now includes keyboard shortcuts.
	Changed functionality	8.0	You can now enter up to 4KB of text when defining flexible option values of configuration objects. Disabled users can no longer log in to any Genesys Application.
Local Control Agent	New functionality	8.0	The Genesys Deployment Agent is now deployed with LCA. The Genesys Deployment Agent works with Genesys Administrator to deploy Genesys Applications and Solutions on the Host.
Solution Control Server	New functionality	8.0	In a Distributed Solution Control environment, any Solution Control Server can detect the failure of a remote site controlled by another Solution Control Server. You can now use the mlcmd.exe command line utility to stop and start Applications and Solutions; to retrieve the status of Applications, Solutions, and Hosts; and to create and send a custom log message.

Table 2: Framework Component Changes Between Release 6.0 and 8.0 (Continued)

Current Component Name	Type of Change	Change Occurred in Release	Details
Solution Control Interface	New functionality	8.0	<p>You can now shut down an Application gracefully, if the Application supports Graceful Stop. Likewise, you can shut down a Solution gracefully, if the Applications that make up the Solution support Graceful Stop.</p> <p>After a user logs in, the date and time when anyone last logged in using that account is displayed.</p> <p>Platform status is now color-coded, to provide a quick visual reference as to the state of the system.</p> <p>A user can now be granted read-only access to the alarm interface, allowing them to monitor system status, including alarms, but prohibiting them from clearing alarms.</p> <p>The on-line Help file now includes keyboard shortcuts.</p>
Logs and Alarms	Changed functionality	8.0	<p>You can now specify a greater number of files (segments) before logs expire.</p>
Wizard Manager	New functionality	8.0	<p>Now supports the user inactivity timeout feature introduced in 7.6.</p>
Configuration Import Wizard	New functionality	8.0	<p>You can now enter configuration changes data in an XML file, and then use the new x2c.exe command line utility to apply those changes to the configuration data.</p>
External Authentication	New functionality	8.0	<p>New log events allow users to better monitor the connection between Configuration Server and the RADIUS or LDAP external authentication server.</p> <p>When logging in, you will receive messages from the RADIUS and LDAP servers indicating the success or failure of your login.</p> <p>You can now configure Configuration Server to accept an empty password if the external authentication server allows it.</p>

Table 2: Framework Component Changes Between Release 6.0 and 8.0 (Continued)

Current Component Name	Type of Change	Change Occurred in Release	Details
Management Framework Deployment Manager	Removed functionality	8.0	Replaced by the Deployment Wizard in Genesys Administrator.
Configuration Server	New functionality	7.6	You can now improve system performance for large History Log updates.
	Changed functionality	7.6	By default, new users are no longer added automatically to a user group. To enable new users created in 7.6 to be assigned automatically to pre-defined Access Groups, you must manually disable this feature.
Configuration Manager	New functionality	7.6	During installation, you can configure the circumstances under which a Security Banner, which you can also design, to appear at login. You can now configure a time period after which users who have been inactive during that time will be forced to log in again.
Solution Control Interface	New functionality	7.6	During installation, you can configure the circumstances under which a Security Banner, which you can also design, to appear at login. You can now configure a time period after which users who have been inactive during that time will be forced to log in again.
External Authentication	New functionality	7.6	You can now configure multiple LDAP external authentication servers.
Logs and Alarms	New functionality	7.6	You can now customize log events for an application by changing the log level of an event, or by disabling the event.
DB Server	New functionality	7.5	You can now configure multiple listening ports on those DB Server Application objects which are configured using a configuration file. You can now secure specified ports with Genesys Security using the TLS Protocol.

Table 2: Framework Component Changes Between Release 6.0 and 8.0 (Continued)

Current Component Name	Type of Change	Change Occurred in Release	Details
Configuration Server	New functionality	7.5	<p>You can now configure multiple listening ports on Configuration Server.</p> <p>You can now secure specified ports with Genesys Security using the TLS Protocol.</p> <p>History log functionality is now mandatory.</p> <p>You can now configure Configuration Server to accept or reject a blank password.</p>
Configuration Manager	New functionality	7.5	<p>You can now configure all objects and parameters for Cost-based Routing in Configuration Manager.</p> <p>Campaign groups can be associated with multiple servers.</p>
Genesys Security Pack on UNIX	New component	7.5	Enables Genesys Security using the TLS Protocol on UNIX platforms.
Message Server	New functionality	7.5	<p>Message Server can now connect to DB Server or Configuration Server as a client using a secure connection.</p> <p>You can now control how many messages Message Server sends to DB Server without waiting for a response.</p>
Solution Control Server (SCS)	New functionality	7.5	<p>You can now configure multiple listening ports on a Solution Control Server.</p> <p>You can now secure specified ports with Genesys Security using the TLS Protocol.</p> <p>You can now distribute control over a primary and backup server in a redundant pair between different Distributed Solution Control Servers.</p>
External authentication	New functionality	7.5	You can now configure multiple RADIUS external authentication servers.

Table 2: Framework Component Changes Between Release 6.0 and 8.0 (Continued)

Current Component Name	Type of Change	Change Occurred in Release	Details
Logs and alarms	New functionality	7.5	<p>Log messages and alarms generated by the SCS are now processed without using the Message Server.</p> <p>You can now control the size of the Log Messages queue when the connection between Message Server and DB Server is unavailable.</p> <p>SCS and LCA logs now include a date and time stamp.</p> <p>An alarm is now visible only if you have access to the application that generated the alarm.</p> <p>Alarm reaction parameters now include the host name.</p> <p>The Alarm Reaction Wizard now enables you to customize the Subject line and content of e-mail alarm reactions.</p>
Configuration Wizards	New functionality	7.5	<p>You can now install configuration wizards from the appropriate product DVD, and run the wizards from a common Wizard Manager.</p> <p>The Common Wizard Component Set is no longer required. There is no longer any dependency between wizards of any application.</p>
Configuration Import Wizard (CIW)	New functionality	7.5	<p>CIW now contains utilities to support configuration data import from the Cisco CallManager switch.</p>
Login	Removed functionality	7.5	<p>Backup server information is removed from the login dialog for the Solution Control Interface module.</p>
External Authentication	New functionality	7.2	<p>In a Managed Services environment, different Tenants can now authenticate through different LDAP servers.</p>
Configuration Manager	New functionality	7.2	<p>Now you can associate a Supervisor with an Agent Group.</p> <p>Now you can specify automatic or manual reconnection.</p> <p>Search function now accepts wildcard characters ? and * and can be case-insensitive.</p>

Table 2: Framework Component Changes Between Release 6.0 and 8.0 (Continued)

Current Component Name	Type of Change	Change Occurred in Release	Details
Login	Removed functionality	7.2	Backup server information removed from login dialog for these modules: <ul style="list-style-type: none"> • Configuration Manager • Genesys Wizard Manager
Configuration Import Wizard	New functionality	7.1.1	CIW no longer requires a separately-purchased license, and can be run from the Configuration Manager Tools menu.
Login	New functionality	7.1.1	New Login dialog for these modules includes backup server information: <ul style="list-style-type: none"> • Configuration Manager • Genesys Wizard Manager • Solution Control Interface
Log Events	New functionality	7.1	You can control delivery of specified log events from specified applications and application types.
LDAP authentication	New functionality	7.1	Framework now supports external authentication for the Lightweight Directory Access Protocol (LDAP) servers: Novell E-Directory, IBM Tivoli Directory Server, Microsoft Active Directory.
Configuration Manager	New functionality	7.1	Users can view help for program errors directly from the menu bar.
Configuration Server	New functionality	7.1	Configuration Server supports Stat Server's new ability to collect Virtual Agent Group (VAG)-based data. Configuration Server also checks VAGs converted from earlier installations and displays a message if it finds errors.
Management Layer	New functionality	7.1	The Management Layer supports Genesys Enterprise Telephony Software (GETS) functionality.
Solution Control Interface	New functionality	7.1	SCI now connects to the Configuration Server backup, after a lost connection, without requesting login information.
SCI / SCS	New functionality	7.1	SCI/SCS in the Management Layer can now detect probable stuck calls and either clear them automatically or notify you to do it manually.

Table 2: Framework Component Changes Between Release 6.0 and 8.0 (Continued)

Current Component Name	Type of Change	Change Occurred in Release	Details
Solution Control Server	New functionality	7.1	SNMP Trap messages generated by Solution Control Server now include host information.
Solution Control Server	New functionality	7.1	The Management Layer supports ADDP trace output for Local Control Agent and Solution Control Server—which used to appear only in <code>stdout</code> —now also appears in the log file.
Local Control Agent	New functionality	7.1	You can now name a non-default configuration file, in the command line, when you start Local Control Agent.
SNMP Master Agent	New functionality	7.1	SNMP Master Agent supports the “Clearance” alarm level for SNMP Traps
Licensing	New functionality	7.0.1	License control for redundant configurations is now enforced. You must have a special high-availability (HA) license to operate any Genesys server in a redundant configuration, whether with the redundancy type warm standby or hot standby.
Configuration Server	New functionality	7.0.1	Configuration Server now supports certain third-party authentication systems. You can integrate Genesys software with your established security system, which may provide functions that Genesys does not provide. Essentially, you can deploy your system to control user access to Genesys applications and avoid creating an additional security schema in your Genesys configuration environment.
Configuration Manager	configuration object handling	7.0.1	You can perform the same configuration operation over multiple configuration objects in Configuration Manager simultaneously. The Enumerator and Enumerator Value configuration objects are now called Business Attribute and Attribute Value respectively. In addition, the Configuration Database provides an increased number of predefined objects of these types.

Table 2: Framework Component Changes Between Release 6.0 and 8.0 (Continued)

Current Component Name	Type of Change	Change Occurred in Release	Details
Configuration Import Wizard	New functionality	7.0.1	Support for new data sources is added to the Configuration Import Wizard, including: <ul style="list-style-type: none"> • Microsoft Excel documents. • NEC APEX 7400 switch configuration.
Solution Control Interface	New functionality	7.0.1	You can use new commands in SCI to start all or a set of configured solutions. SCI now supports ADDP (Advanced Disconnect Detection Protocol) for its connection to Solution Control Server (SCS) and prompts users to reconnect to the backup SCS once the connection to the primary SCS is lost.
Solution Control Server	Licensing	7.0.1	SCS now requires a special HA license to perform a switchover between primary and backup servers for all Genesys applications.
Configuration Server Proxy	Removed	7.0	Configuration Server 7.0, when running in Proxy mode, provides support for geographically distributed environments.
Management Framework Deployment Manager	Newly implemented	7.0	
Configuration Server Proxy	Newly implemented	6.5	
Genesys SNMP Master Agent	Newly implemented	6.5	Optional Management Layer component that has been implemented since the initial 6.5 release.
Configuration Conversion Utility	Removed	6.1	Replaced with Configuration Conversion Wizard
Configuration Conversion Wizard	Newly implemented	6.1	
Database Initialization Wizard	Newly implemented	6.1	

Table 2: Framework Component Changes Between Release 6.0 and 8.0 (Continued)

Current Component Name	Type of Change	Change Occurred in Release	Details
Configuration Import Wizard	Newly implemented	6.1	
All server applications	Support of unified log options is added.	6.0	See Page 99 for more information.
All server applications	ADDP support is added.	6.0	Advanced Disconnect Detection Protocol (ADDP) can be enabled for server connections. Refer to the <i>Framework 7.6 Deployment Guide</i> for more information.
DB Server	Differentiation between two types of DB Server is made.	6.0	DB Server for the Configuration Database continues retrieving its settings from a configuration file. DB Server for other databases retrieves its configuration settings from the Configuration Database.
Local Control Agent	Newly implemented	6.0	Management Layer component If you want to use the Management Layer, you must manually install Local Control Agent (LCA) on every computer that runs Genesys servers. Install LCA from the Management Framework DVD using the instructions documented in the <i>Framework 7.6 Deployment Guide</i> .
Message Server	Newly implemented	6.0	Management Layer component
Solution Control Interface	Newly implemented	6.0	Management Layer component
Solution Control Server	Built-in SNMP (Simple Network Management Protocol) support added	6.5	Support for SNMP-compliant network management systems (NMS) has been enhanced since the initial 6.5 release.
	Newly implemented	6.0	Management Layer component

Table 2: Framework Component Changes Between Release 6.0 and 8.0 (Continued)

Current Component Name	Type of Change	Change Occurred in Release	Details
Configuration Wizards	Newly implemented	6.0	

Configuration Option Changes for Framework

This section documents all configuration option changes in specific Framework server components from release 6.0 through 8.0, with the most recent changes listed first. The changes are listed by component.

Where to find detailed descriptions of the configuration options

Refer to the *Framework 8.0 Configuration Options Reference Manual* for detailed descriptions of all of the Framework configuration options, with the following exceptions:

- Configuration options for the Configuration Conversion Wizard are described in detail in “Configuration Options Description” on [page 77](#).
- Configuration options related to Genesys security features are described in detail in the latest version of the *Genesys Security Deployment Guide*.
- Configuration options related to external authentication are described in detail in the *Framework 8.0 External Authentication Reference Manual*.

General Configuration Option Changes

Table 3 on [page 100](#) documents all changes in common configuration options (that is, those that are supported by all Genesys server applications), from release 6.0 through 8.0, with the most recent changes listed first.

Starting with release 6.0, all Genesys server applications support the unified set of log options (called *common log options*) in addition to application-specific log options. The common log options are configured for each application in the following sections: `log`, `log-extended`, `log-filter`, and `log-filter-data`.

Note: Leaving the default settings for the common log options might adversely affect performance in production mode.

Starting with release 7.6, all Genesys Server application also support a set of common options for operations that are not related to logs. The common options are configured for each application in a section called `common`.

Table 3: Common Option Changes

Current Option Name	Configuration Section Name	Type of Change	Change Occurred in Release #	Additional Information
expire	log	New values	8.0	New range: 1–1000 files
default-filter-type	log-filter	New values	8.0	
<key-name>	log-filter-data	New values	8.0	
disable-rbac	security	New	8.0	The security section is new in 8.0.
heartbeat-period	sml	New	8.0	
heartbeat-period-thread-class-<n>	sml	New	8.0	
hangup-restart	sml	New	8.0	
suspending-wait-timeout	sml	New	8.0	
alarm	log	Moved	7.6	Moved from Solution Control Server.
x-conn-debug-open	log	New	7.6	Use only when requested by Genesys Technical Support.
x-conn-debug-select	log	New	7.6	
x-conn-debug-timers	log	New	7.6	
x-conn-debug-write	log	New	7.6	
x-conn-debug-security	log	New	7.6	
x-conn-debug-api	log	New	7.6	
x-conn-debug-dns	log	New	7.6	
x-conn-debug-all	log	New	7.6	

Table 3: Common Option Changes (Continued)

Current Option Name	Configuration Section Name	Type of Change	Change Occurred in Release #	Additional Information
rebind-delay	common	New	7.6	Use only when requested by Genesys Technical Support. The common section is new in 7.6.
enable-async-dns	common	New	7.6	Use only when requested by Genesys Technical Support. Use only with T-Servers.
level-reassign- <code><eventID></code>	extended-log	New	7.6	The extended-log section is new in 7.6.
level-reassign-disable	extended-log	New	7.6	
default-filter-type	log-filter	New	7.2	The log-filter section is new in 7.2.
<code><key name></code>	log-filter-data	New	7.2	The log-filter-data section is new in 7.2.
keep-startup-file	log	New	7.1	This option applies only to T-Servers.
verbose	log	New values	7.0	New values: interaction, debug
buffering	log	See Details	7.0	The option now applies to stderr and stdout output instead of log-file output as in 6.x.
memory-storage-size	log	New	7.0	
message_format	log	New default value	7.0	New default value: short

Table 3: Common Option Changes (Continued)

Current Option Name	Configuration Section Name	Type of Change	Change Occurred in Release #	Additional Information
time_format	log	New value; new default value	7.0	New value (which is the new default): time
print-attributes	log	New	7.0	
check-point	log	New	7.0	
memory	log	New	7.0	
spool	log	New	7.0	
all	log	New output level	7.0	New level: memory
standard	log	New output level	7.0	New level: memory
interaction	log	New	7.0	
trace	log	New output level	7.0	New level: memory
		See Details	7.0	Log events of higher levels are now also sent to the specified output.
debug	log	New output level	7.0	New level: memory
		See Details	7.0	Log events of higher levels are now also sent to the specified output.
eventloghost	log	Obsolete	6.5	Removed from common log options as an option specific to Solution Control Server.

Table 3: Common Option Changes (Continued)

Current Option Name	Configuration Section Name	Type of Change	Change Occurred in Release #	Additional Information
alarm	log	Obsolete	6.5	Removed from common log options as an option specific to Solution Control Server.
message_format	log	New	6.5	Introduced after the initial 6.5 release.
time_convert	local, utc	New	6.5	Introduced after the initial 6.5 release.
		See Details	6.5	The option name was misspelled in a prior release of the document.
time_format	locale, ISO8601	New	6.5	Introduced after the initial 6.5 release.

DB Server

[Table 4](#) lists all configuration option changes in DB Server from release 6.0 through 8.0, with the most recent changes listed first.

Table 4: Option Changes in DB Server

Current Option Name	Configuration Section Name	Type of Change	Change Occurred in Release #	Additional Information
db-request-timeout	dbserver	New	8.0	
dbprocess_name	dbserver	Corrected values	8.0	Removed ./ from values.
db2_name	dbserver	New and corrected values	8.0	New values: ./dbclient_db_32, ./dbclient_db2_64 Corrected value: ./dbclient_db2
informix_name	dbserver	Corrected value	8.0	Corrected value: ./dbclient_informix

Table 4: Option Changes in DB Server (Continued)

Current Option Name	Configuration Section Name	Type of Change	Change Occurred in Release #	Additional Information
mysql_name	dbserver	Corrected value	8.0	Corrected value: ./dbclient_mysql
oracle_name	dbserver	New and corrected values	8.0	New values: ./dbclient_oracle_32, ./dbclient_oracle_64 Corrected value: ./dbclient_oracle
sybase_name	dbserver	Corrected value	8.0	Corrected value: ./dbclient_sybase
transport	dbserver	New	7.5	
dbprocess_number	dbserver	Correction	7.1	The default value and valid values were incorrectly documented in the previous releases of the document.
client_stop_timeout	dbserver	New	6.5	
dbprocess_number	dbserver	New	6.5	
		See Details	6.5	The option name was misspelled in a prior release of the document. The correct name is <i>dbprocess_number</i> . The initially documented valid values were: 0 or any positive integer.

Table 4: Option Changes in DB Server (Continued)

Current Option Name	Configuration Section Name	Type of Change	Change Occurred in Release #	Additional Information
verbose	dbserver	See Details	6.1	The option is reintroduced. See the <i>DB Server 6.1 Release Note</i> for the exact release number. The option must be specified in the DB Server section. Do not confuse it with the common log option that has the same name.
lcaport	lca	New	6.0	
verbose	dbserver	Obsolete	6.0	

Database Access Point

[Table 5](#) lists all configuration option changes in Database Access Point from release 6.0 through 8.0, with the most recent changes listed first.

Table 5: Option Changes in Database Access Point

Current Option Name	Configuration Section Name	Type of Change	Change Occurred in Release #	Additional Information
db-request-timeout	dbserver	New	8.0	

Configuration Server

[Table 6](#) documents all configuration option changes in Configuration Server from release 6.0 through 8.0, with the most recent changes listed first. These options apply to Configuration Server operating in Master mode.

[Table 7 on page 109](#) documents configuration option changes in Configuration Server 8.0 running in Proxy mode (also referred to as *Configuration Server Proxy*).

Table 6: Option Changes in Configuration Server

Current Option Name	Configuration Section Name	Type of Change	Change Occurred in Release #	Additional Information
allow-external-empty-password	confserv	New	8.0	
last-login	confserv	New	8.0	
last-login-synchronize	confserv	New	8.0	
disable-vag-calculation	<application>	New	7.6	Not documented in previous versions of this document.
all	history-log	New value	7.6	New value: :memory: Not documented in previous versions of this document.
history-log-file-name	confserv	Obsolete	7.6	Replaced by options in history-log section.
history-log-expiration	confserv	Obsolete	7.6	
history-log-client-expiration	confserv	Obsolete	7.6	
history-log-max-records	confserv	Obsolete	7.6	
history-log-active	confserv	Obsolete	7.6	
no-default-access	security	New	7.6	
all	history-log	New	7.6	
expiration	history-log	New	7.6	
client-expiration	history-log	New	7.6	
max-records	history-log	New	7.6	
active	history-log	New	7.6	
failsafe-store-processing	history-log	New	7.6	

Table 6: Option Changes in Configuration Server (Continued)

Current Option Name	Configuration Section Name	Type of Change	Change Occurred in Release #	Additional Information
backlog	N/A	New	7.6	Use only when requested by Genesys Technical Support. Defined in Application Parameters section on the Advanced tab of Port Properties in Configuration Manager.
history-log-save	confserv	Obsolete	7.5	
history-log-file-save	confserv	Obsolete	7.5	
history-log-keep	confserv	Obsolete	7.5	
history-log-scan	confserv	Obsolete	7.5	
history-log-expiration	confserv	New	7.5	
history-log-client-expiration	confserv	New	7.5	
history-log-max-records	confserv	New	7.5	
history-log-active	confserv	New	7.5	
allow-empty-password	confserv	New	7.5	
transport	dbserver	New	7.5	
schema	hca	See Details	7.5	The hca section is not required for users of Genesys InfoMart 7.5 or later.
force-reconnect-reload	confserv	New	7.2	
addp	dbserver	New	7.1	
addp-timeout	dbserver	New	7.1	
addp-trace	dbserver	New	7.1	
dbcheck	confserv	Obsolete	7.0	
encoding	confserv	New	7.0	
locale	confserv	New	7.0	

Table 6: Option Changes in Configuration Server (Continued)

Current Option Name	Configuration Section Name	Type of Change	Change Occurred in Release #	Additional Information
schema	hca	New	7.0	The hca section is new to release 7.0.
port	soap	New	7.0	The soap section is new to release 7.0.
debug	soap	New	7.0	
client_lifespan	soap	New	7.0	
encryption	confserv	New	6.5	
client-response-timeout	confserv	New	6.1	See the Configuration Server 6.1 Release Notes for the exact release number.
dbcheck	confserv	New default value	6.1	Old default value: false New default value: true
verbose	confserv	Obsolete	6.0	Replaced with common log options.
log-file-name	confserv	Obsolete	6.0	
log-file-size	confserv	Obsolete	6.0	
log-remove-old-files	confserv	Obsolete	6.0	
log-check-interval	confserv	Obsolete	6.0	
log-buffering	confserv	Obsolete	6.0	
history-log-mt	confserv	Obsolete	6.0	
history-log-keep	confserv	New default value	6.0	Old default value: 172,800 (48 hours) New default value: 7200

Table 7: Option Changes in Configuration Server Proxy

Current Option Name	Configuration Section Name	Type of Change	Change Occurred in Release #	Additional Information
last-login	csproxy	New	8.0	
last-login-synchronize	csproxy	New	8.0	
proxy-writable	csproxy	New	7.6	Not documented in previous releases of this document.
expiration	history-log	Modified when changes take effect.	7.6	Old Changes Take Effect: After restart New Changes Take Effect: Immediately
client-expiration	history-log		7.6	
max-records	history-log		7.6	
failsafe-store-processing	history-log	New	7.6	
all	history-log	New value	7.6	New value: :memory Not documented in previous releases of this document.
backlog	See Details	New	7.6	Use only when requested by Genesys Technical Support. Defined in Application Parameters section on the Advanced tab of Port Properties in Configuration Manager.
verbose	history-log	Obsolete	7.5	
expire	history-log	Obsolete	7.5	
segment	history-log	Obsolete	7.5	
all	history-log	New default value	7.5	Old default value: trlog New default value: histlog
expiration	history-log	New	7.5	
client-expiration	history-log	New	7.5	
max-records	history-log	New	7.5	

Table 7: Option Changes in Configuration Server Proxy (Continued)

Current Option Name	Configuration Section Name	Type of Change	Change Occurred in Release #	Additional Information
active	history-log	New	7.5	
license-file	license	New	7.0	Unified licensing option. See <i>Genesys Licensing Guide</i> for description. The license section is new to release 7.0.
encoding	csproxy	New	7.0	The csproxy section is new to release 7.0.
locale	csproxy	New	7.0	
verbose	history-log	New	7.0	Note: The history-log section is new to release 7.0.
all	history-log	New	7.0	
segment	history-log	New	7.0	
expire	history-log	New	7.0	
port	soap	New	7.0	Note: The soap section is new to release 7.0.
debug	soap	New	7.0	
client_lifespan	soap	New	7.0	

Configuration Manager

[Table 8](#) documents all configuration option changes in Configuration Manager from release 6.0 through 8.0, with the most recent changes listed first.

Note: This table does not include configuration options for Genesys Administrator, which are set in the Configuration Manager Application object with which Genesys Administrator is bound, or associated, during its deployment.

Table 8: Option Changes in Configuration Manager

Current Option Name	Configuration Section Name	Type of Change	Change Occurred in Release #	Additional Information
inactivity-timeout	security	New	7.6	

Local Control Agent

Starting with release 7.0, Local Control Agents supports common log options which allows you to precisely configure log output for LCA. Because you do not configure an Application object for LCA, if you need to change the default log option settings, create a configuration file called `lca.cfg` and specify new values for appropriate options. The file must be located in the same directory as the Local Control Agent executable file.

For more information on the LCA configuration file and for related instructions, see the *Framework 8.0 Deployment Guide*.

Starting with release 8.0, the Genesys Deployment Agent is deployed with LCA. The Genesys Deployment Agent is used by of Genesys Administrator to deploy Genesys Applications and Solutions on the Host. To enable this functionality, you must identify what port on the Host that the Genesys Deployment Agent will use to communicate with Genesys Administrator. You provide this information in the Host's Annex, in the new section `rdm`, specifying the port number with the configuration option `port`.

For more information about the Genesys Deployment Agent, refer to the *Framework 8.0 Deployment Guide*.

Message Server

[Table 9](#) documents all configuration option changes in Message Server from release 6.0 through 8.0, with the most recent changes listed first.

Table 9: Option Changes in Message Server

Current Option Name	Configuration Section Name	Type of Change	Change Occurred in Release #	Additional Information
signature	MessageServer	Correction	8.0	Not documented in previous releases of this document.
log-queue-exp-time	messages	New	7.5	
log-queue-size	messages	New	7.5	

Table 9: Option Changes in Message Server (Continued)

Current Option Name	Configuration Section Name	Type of Change	Change Occurred in Release #	Additional Information
log-queue-response	messages	New	7.5	
block-messages	db-filter	New	7.1	
block-messages-from-<DBID>	db-filter	New	7.1	
block-messages-by-<type>	db-filter	New	7.1	
db_binding	messages	New	7.0	
thread_mode	messages	New valid value	6.5	The change occurred after the initial 6.5 release.

Solution Control Server

[Table 10](#) documents all configuration option changes in Solution Control Server from release 6.0 through 8.0, with the most recent changes listed first.

Table 10: Option Changes in Solution Control Server

Current Option Name	Configuration Section Name	Type of Change	Change Occurred in Release #	Additional Information
alarm	log	Moved	7.6	Moved to common configuration options.
smtp_from	general	See Details	7.1.1	Documented correctly in 7.2.
max_switchover_time	general	New	7.0	Note: The general section is new to release 7.0.
distributed_mode	general	New	7.0	
distributed_rights	general	New	7.0	
alive_timeout	general	New	7.0	
alarm	log	New value	7.0	New value: memory

Table 10: Option Changes in Solution Control Server (Continued)

Current Option Name	Configuration Section Name	Type of Change	Change Occurred in Release #	Additional Information
smtp_host	mailer	New	6.5	
smtp_port	mailer	New	6.5	

Solution Control Interface

[Table 11](#) documents all configuration option changes in Solution Control Interface from release 6.0 through 8.0, with the most recent changes listed first.

Table 11: Option Changes in Solution Control Interface

Current Option Name	Configuration Section Name	Type of Change	Change Occurred in Release #	Additional Information
critical-color	host-status-display	New	8.0	Note: The host-status-display section is new to 8.0.
major-color	host-status-display	New	8.0	
other-color	host-status-display	New	8.0	
inactivity-timeout	security	New	7.6	

Genesys SNMP Master Agent

[Table 12](#) documents all configuration option changes in Genesys SNMP Master Agent from release 6.5 through 8.0, with the most recent changes listed first.

Table 12: Option Changes in SNMP Master Agent

Current Option Name	Configuration Section Name	Type of Change	Change Occurred in Release #	Additional Informations
v3priv_protocol	snmp	Removed value	8.0	Unsupported value: IDEA Value included incorrectly in previous releases on this document.

Table 12: Option Changes in SNMP Master Agent (Continued)

Current Option Name	Configuration Section Name	Type of Change	Change Occurred in Release #	Additional Informations
mode	agentx	Removed value	7.1.1	Obsolete value: UNIX Deletion not recorded in previous releases of this document.
unix_port	agentx	Obsolete	7.1.1	Change not recorded in previous releases of this document.
trap_host	snmp	Obsolete	7.0	The new option trap_target replaces this option.
trap_port	snmp	Obsolete	7.0	The new option trap_target replaces this option.
trap_target	snmp	New	7.0	



Chapter

8

Upgrade of Framework Components

This chapter describes how to upgrade applications that belong to the Genesys Framework after you have successfully converted the configuration data. It discusses the following topics:

- [Upgrade Overview, page 115](#)
- [Migrating Framework Components to 8.0, page 116](#)

Note: To migrate Configuration Server Proxy 6.5, refer to Chapter 4 on [page 69](#).

To migrate the SNMP Option, refer to Chapter 9 on [page 125](#).

To migrate Stat Server, refer to the chapter “Stat Server Migration”.

To migrate T-Servers, refer to the T-Server sections in this guide.

Upgrade Overview

After you have successfully converted the Configuration Database to 8.0 format, install Framework 8.0 components. The *Framework 8.0 Deployment Guide* provides recommendations for planning the Genesys Framework 8.0 installation. The *Framework 8.0 Deployment Guide* also describes the configuration, installation, and startup procedures.

During the configuration procedure, you can skip configuration of the entities present in the database as a result of the database conversion. Or you can modify the preexisting components to enable new options and functions. If you are using Configuration Wizards for component deployment, they will show these configuration entities as existing.

Note: Converting your database with the Configuration Conversion Wizard (CCW) does not register the Framework instance in the Configuration Database. When you are deploying Framework components or Genesys solutions with Configuration Wizards, you must first run the Framework Configuration Wizard, which identifies the Framework-related objects in the database and registers a Framework instance.

After completing the 8.0 installations of previously configured components, check or modify the configuration parameters to enable the new features and capabilities you would like to use. The *Framework 8.0 Deployment Guide* helps you to evaluate features introduced to Genesys Framework in the latest releases. The *Framework 8.0 Configuration Options Reference Manual* describes configuration options for Framework components and highlights newly introduced and retired options. The *Framework 8.0 Management Layer User's Guide* describes how to enable Management Layer functionality.

To take full advantage of the new features and functionality offered in a particular release, Genesys recommends all software components be of the same release whenever possible—particularly, the Configuration Layer and the Management Layer. These two layers function as a unit in many respects.

Migrating Framework Components to 8.0

Complete these preliminary procedures before upgrading your Framework components:

1. If you are using Configuration Server Proxies 6.5 in a distributed environment, you must upgrade every Configuration Server Proxy 6.5 to Configuration Server 7.0 or later running in Proxy Mode before you convert your Configuration Database or upgrade any other Framework component. Refer to Chapter 4 on [page 69](#) for instructions.
2. Install FLEXlm License Manager, version 9.5
You should have the license files for 8.0 components.
Licensing is addressed in:
 - *Genesys Licensing Guide*
 - Chapter 2, “Licensing Migration,”
3. Migrate the Configuration Database. See Chapter 6 on [page 81](#).

The following information summarizes the migration of Framework components from release 7.6 or earlier:

1. Install physical 8.0 applications for each converted Application object.
2. Modify the configuration of converted Application objects for server applications to enable or disable new functionality as required. This can include:

- Configuration options newly introduced for this application. See “Configuration Option Changes for Framework” on [page 99](#).
- In distributed configuration environments, replacing connections to older Configuration Server Proxies with connections to updated Configuration Servers running in Proxy mode.
- Enabling ADDP for any connections. This is optional.
- Disabling the automatic assignment of new users to access groups. See “Disabling No Default Access for New Users” on [page 118](#).

Note: Starting in release 7.5, Configuration Server does not support backward compatibility of Keep-Alive Protocol (KPL) for release 6.5 clients. If you used KPL with previous Genesys versions, consider using Automatic Disconnect Detection Protocol (ADDP). Refer to the Framework 8.0 Deployment Guide for information about ADDP.

3. Update Contact Center configuration objects as needed:
 - Alarm Conditions
 - Alarm Reactions

Migration Procedures

Follow these migration procedures for Framework components.

Upgrading Configuration Layer

Warning! If you are using Configuration Server Proxies 6.5 in a distributed environment, you must upgrade every Configuration Server Proxy 6.5 to Configuration Server 7.0 or later running in Proxy Mode before you convert your Configuration Database or upgrade any other Framework component. Refer to Chapter 4 on [page 69](#) for instructions.

Notes:

- Skip this section if you have already upgraded the Configuration DB Server and Configuration Server as part of migrating the Configuration Database (see “Installing the Configuration Layer” on [page 75](#)).
 - Configuration Server 8.0 consumes 2.5 times more memory than Configuration Server 6.x (but not more than 7.x versions). Allocate at least 1 GB of virtual memory to Configuration Server 8.0 and adjust RAM as needed after you monitor Configuration Server 8.0 operations.
-

To Upgrade the Configuration Layer

To set up the components of the 8.0 Configuration Layer that are required for the migration procedure, you must:

1. Install DB Server 8.0 and configure it to work with the existing Configuration Database.
2. Install Configuration Server 8.0.

Warning! Do not execute the database initialization scripts.

3. Install Configuration Manager 8.0.
4. In geographically distributed environments, install as many release 8.0 Configuration Server Proxies as required.

For installation and configuration instructions for the Configuration Layer components, refer to the *Framework 8.0 Deployment Guide*.

Disabling No Default Access for New Users

Starting in release 7.6, new users are not automatically assigned to Access Groups, by default. Users created prior to release 7.6 retain their existing permissions and Access Groups assignments. If you want new users to be assigned automatically to pre-defined Access Groups, as was done in release 7.5 and earlier, you must disable this feature as follows:

1. Open the release 7.6 Configuration Server Application object Properties dialog box.
2. Select the Options tab.
3. If the security section does not exist, create it.
4. In the security section, set the no-default-access configuration option to one (1) and click OK. This will give new users the same default Access Group assignments and permissions as were given in release 7.5 or earlier.
5. Click OK.

Refer to the chapter “No Default Access for New Users” of the *Genesys 8.0 Security Deployment Guide* for more information about this feature and its configuration option.

Upgrading DB Server

Note: This section describes an upgrade of a DB Server for databases other than the Configuration Database.

To Upgrade DB Server

For each DB Server Application object whose data was converted from the release 7.5 or earlier database:

1. In Configuration Manager, back up the existing configuration option settings in a *.cfg or *.conf file, using the Export button on the toolbar of

the Options tab in the Application Properties dialog box. Save this *.cfg or *.conf file in a secure location in case of a rollback. Refer to *Framework 8.0 Configuration Manager Help* for a description of the Export function.

2. Install a physical DB Server 8.0 application. For installation instructions, refer to the *Framework 8.0 DB Server User's Guide*.
3. Verify the following parameters on the Start Info tab of the DB Server Application object in Configuration Manager: the DB Server working directory, the executable name, and command-line parameters.
4. Specify any new configuration options on the Options tab of the DB Server Application object in Configuration Manager. See Table 6 on [page 106](#) for details.
5. If you have not previously used the centralized-logging and alarm-signaling capabilities of Management Layer, but would like to do so now, add a connection to Message Server on the Connections tab of the DB Server Application object in Configuration Manager. Do this after you have configured Application objects for the Management Layer components.
6. If using the Configuration Server Proxy to notify this DB Server about configuration changes, use Genesys Administrator or Configuration Manager to add a connection to the Configuration Server Proxy.

To Roll Back If you need to return to your release 7.6 or earlier Genesys installation:

1. If any DB Server configuration options have been changed, restore the previously configured settings by importing the *.cfg or *.conf file in which you backed up DB Server release 7.6 or earlier configuration options. To do so, use the Import button on the toolbar of the Options tab in the Application Properties dialog box in Configuration Manager. Refer to *Framework 8.0 Configuration Manager Help* for a description of the Import function.
2. Delete any new connections to server applications that you have configured for the DB Server Application object in Genesys Administrator or Configuration Manager.
3. Uninstall DB Server 8.0.

**To Upgrade
Database Access
Points**

For each Database Access Point Application object whose data was converted from the release 7.6 or earlier database, verify that this Database Access Point references the 8.0 database. For additional instructions, refer to the *Framework 8.0 DB Server User's Guide*.

To Roll Back If you need to return to your release 7.6 or earlier Genesys installation, verify that this Database Access Point references the release 7.6 or earlier database.

Upgrading Message Server

To Upgrade Message Server

For each Message Server Application object whose data was converted from the release 7.6 or earlier database:

1. In Configuration Manager, back up the existing configuration option settings in a *.cfg or *.conf file using the Export button on the toolbar of the Options tab in the Application Properties dialog box. Save this *.cfg or *.conf file in a secure location in case of rollback. Refer to *Framework 8.0 Configuration Manager Help* for a description of the Export function.
2. Install a physical Message Server 8.0 application. For installation instructions, refer to the *Framework 8.0 Deployment Guide*.
3. Verify the following parameters on the Start Info tab of the Message Server Application object in Configuration Manager: the Message Server working directory, the executable name, and command-line parameters.
4. If you are using the Configuration Server Proxy to notify this Message Server about the configuration changes, add Configuration Server Proxy to the Connections tab of the Message Server Application object in Configuration Manager.

To Roll Back

If you need to return to your release 7.6 or earlier Genesys installation:

1. If any Message Server configuration options have changed, restore the previously configured settings by importing the *.cfg or *.conf file in which you backed up the release 7.6 or earlier Message Server configuration options. To do so, use the Import button on the toolbar of the Options tab in the Application Properties dialog box in Configuration Manager. Refer to *Framework 8.0 Configuration Manager Help* for a description of the Import function.
2. Delete any new connections to server applications that you have configured on the Connections tab of the Message Server Application object in Configuration Manager.
3. Uninstall Message Server 8.0.

Upgrading the Log Database

If you are upgrading from a release earlier than 7.0, you must upgrade your Log Database after you install Message Server.

To Upgrade the Log Database from 7.0 or earlier

Using your DBMS tools, load the upgrade script appropriate to your DBMS type. The scripts are located in the scripts folder within the directory to which you installed Message Server. [Table 13](#) lists database types and their corresponding upgrade script names for an enterprise or multi-tenant environment.

To upgrade the Log Database to 8.0.2

If you have upgraded your Message Servers to 8.0.2 or later, you must also upgrade your Log Databases to be compatible with the new Message Servers. Refer to the *Message Server 8.0.2 Release Note* for instructions.

Table 13: Log Database Upgrade Scripts

Database Type	Script Name
DB2	upgrade_6X270_db2.sql
Informix	upgrade_6X270_informix.sql
Microsoft SQL	upgrade_6X270_mssql.sql
Oracle	upgrade_6X270_oracle.sql
Sybase	upgrade_6X270_sybase.sql

Upgrading Local Control Agent

Note: When you stop and uninstall Local Control Agent (LCA), SCS recognizes the loss of connection as a failure of the host. Thus, SCS would perform switchover for redundant pairs whose primary server is running on the host where LCA is down. If you want to avoid switching operations over to backup servers, either stop SCS before upgrading LCA or identify which applications are running as primary on the LCA's host and stop corresponding backup servers; restart either SCS or the backup servers respectively after the upgrade.

To Upgrade the Local Control Agent

For each host computer on which you were running LCA in your release 7.6 or earlier environment:

1. Uninstall the release 7.6 or earlier LCA release.
2. Change the LCA Port property in the appropriate Host Properties window if necessary.
3. Install LCA release 8.0. For installation instructions, refer to the *Framework 8.0 Deployment Guide*.

Note: If you want to use the Management Layer, you must manually install LCA on every computer that runs Genesys servers. Install LCA from the Management Framework DVD using the instructions documented in the *Framework 8.0 Deployment Guide*.

To RollBack

If you need to return to your release 7.6 or earlier Genesys installation, do not make any modifications to your LCA installation. LCA 8.0 is fully backward compatible and you can use it in a release 7.6 or earlier environment.

Upgrading Solution Control Server

To Upgrade the Solution Control Server

For each Solution Control Server Application object whose data was converted from the release 7.6 or earlier database:

1. In Configuration Manager, back up the existing configuration option settings in a *.cfg or *.conf file using the Export button on the toolbar of the Options tab in the Application Properties dialog box. Save this *.cfg or *.conf file in a secure location in case of rollback. Refer to *Framework 8.0 Configuration Manager Help* for a description of the Export function.
2. Install a physical Solution Control Server 8.0 application. For installation instructions, refer to the *Framework 8.0 Deployment Guide*.
3. Verify the following parameters on the Start Info tab of the Solution Control Server Application object in Configuration Manager: the Solution Control Server working directory, the executable name, and command-line parameters.
4. Specify any new configuration options on the Options tab of the Solution Control Server Application object in Configuration Manager. See Table 10 on [page 112](#) for details.
5. If you have not previously used the centralized-logging and alarm-signaling capabilities of the Management Layer, but want to use them now, add a connection to Message Server on the Connections tab of the Solution Control Server Application object in Configuration Manager. Do this after you have configured an Application object for Message Server.
6. If using the SNMP Option to provide alarm reactions, verify that the SNMP Master Agent Application is added to the Connections tab of the Solution Control Server Application object in Configuration Manager. Do this after you have configured an Application object for SNMP Master Agent.

Note: See Chapter 9, “Migration of SNMP Option,” on [page 125](#), for instructions for upgrading the SNMP Option.

7. If using Configuration Server Proxy to notify this Solution Control Server about configuration changes, add Configuration Server Proxy to the Connections tab of the Solution Control Server Application object in Configuration Manager.

To Roll Back

If you need to return to your release 7.6 or earlier Genesys installation:

1. If any SCS configuration options have been changed, restore previously configured settings by importing the *.cfg or *.conf file in which you exported release 7.6 or earlier Solution Control Server configuration options. To do so, use the Import button on the toolbar of the Options tab in

the Application Properties dialog box in Configuration Manager. Refer to *Framework 8.0 Configuration Manager Help* for a description of the Import function.

2. Delete any new connections to server applications that you have configured on the Connections tab of the Solution Control Server Application object in Configuration Manager.
3. Uninstall Solution Control Server 8.0.

Upgrading Solution Control Interface

To Upgrade the Solution Control Interface

For each Solution Control Interface Application object whose data was converted from the release 7.6 or earlier database:

1. Install as many physical Solution Control Interface 8.0 applications as needed. For installation instructions, refer to the *Framework 8.0 Deployment Guide*.
2. Verify that a connection to the correct Solution Control Server is configured on the Connections tab of the Solution Control Interface Application object in Configuration Manager.
3. Verify that a connection to the correct Database Access Point is configured on the Connections tab of the Solution Control Interface Application object in Configuration Manager.

To Roll Back

If you need to return to your release 7.6 or earlier Genesys installation:

1. Restore any preexisting connections and delete any new connections to server applications that you have configured on the Connections tab of the Solution Control Interface Application object in Configuration Manager.
2. Uninstall Solution Control Interface 8.0.

Upgrading Stat Server

To Upgrade Stat Server

See the Stat Server chapter in this document.

Migrating Other Configuration Objects

To Migrate Other Configuration Objects

After you have migrated all Framework components, migrate or configure the following objects:

- Alarm Conditions
- Alarm Reactions

Review the recent changes to common log events and log events for each Framework component listed in *Framework 8.0 Combined Log Events Help*. Verify that your Alarm Condition and Alarm Reaction objects are based on currently supported log events. If necessary, make appropriate changes or configure new Alarm Conditions for newly-introduced log events.



Chapter

9

Migration of SNMP Option

Note: This chapter applies ONLY if you are upgrading from a release or Framework prior to 7.0. If you are running a 7.x or later release of Framework, then you have already performed these tasks.

This chapter describes how to migrate from your current SNMP (Simple Network Management Protocol) implementation to the built-in SNMP support available in the 7.0 and later releases of the Management Layer. Because the Genesys SNMP Option in releases earlier than 7.0 consisted of non-Framework (and even non-Genesys) components, its migration is described separately from the Framework components migration. Use the instructions in this chapter after upgrading Framework components.

This chapter contains the following topics:

- [Preliminary Migration Instructions, page 125](#)
- [Migrating from 5.1, page 126](#)
- [Upgrading from 6.0 or 6.1, page 127](#)
- [Upgrading from 6.5, page 128](#)

Preliminary Migration Instructions

Genesys has provided different tools for integration with third-party network management systems (NMS) in different releases. In release 5.1, you could use SNMP Option 5.1 that consisted of Genesys G-Proxy and PATROL™ SNMP Master Agent. In release 6.0, 6.1, and early 6.5, you could still use SNMP Option 5.1 with the addition of Solution Control Server that converted Genesys alarms into SNMP traps.

Starting with the latest 6.5 releases, the Management Layer of Genesys Framework provides a built-in support for SNMP-compliant third-party NMS. This means that Solution Control Server (SCS) not only converts Genesys

alarms into SNMP traps, but it also processes various NMS commands and generates SNMP traps based on changes in the current status of an individual application. In other words, with built-in SNMP support you can access Management Layer functions through your existing NMS interface. For this purpose, you also need an SNMP Master Agent that serves as an interface between the Management Layer and NMS. You can use Genesys SNMP Master Agent or a third-party SNMP master agent that supports the Agent protocol.

Warning! Do not uninstall the obsolete components (such as PATROL SNMP Master Agent, G-Proxy, or a previous release of SCS) until after you test the new SNMP functionality.

Licensing Requirements

The SNMP functionality of the Management Layer is purchased separately and is controlled by the Genesys licensing system. Refer to *Chapter 2, “Licensing Migration,”* in this guide for instructions on how to update your licenses. Refer to the *Genesys Licensing Guide* for information on the Genesys licensing system.

Migrating from 5.1

The SNMP Option 5.1 consisted of Genesys G-Proxy and PATROL™ SNMP Master Agent.

SNMP Option Upgrade Instructions

The following summarizes the migration from the SNMP Option 5.1 to the SNMP built into Management Layer 8.0:

1. Configure and install components of the Management Layer. See the *Framework 8.0 Deployment Guide* for instructions.
2. Configure and install either Genesys SNMP Master Agent or a third-party SNMP master agent that is Agent-compliant. See the *Framework 8.0 Management Layer User’s Guide* for configuration instructions for either application and for installation instructions for Genesys SNMP Master Agent.
3. Update the Genesys MIB file in your NMS. You can find the latest Genesys MIB file in the directory where SCS is installed. Refer to the *Framework 8.0 Management Layer User’s Guide* for the current MIB file description and any differences from your 5.1 file.

Note: Save a backup copy of the Genesys 5.1 MIB file in case of a rollback.

SNMP Option Rollback Instructions

If returning to your SNMP Option 5.1 installation:

1. Replace the Genesys MIB file in your NMS with the 5.1 copy.
2. Uninstall either Genesys SNMP Master Agent or the third-party SNMP master agent.
3. Remove the Master Agent configuration object from the Configuration Database.
4. If you are not using the Management Layer for other purposes, uninstall its components and remove corresponding applications from the Configuration Database.

Upgrading from 6.0 or 6.1

The SNMP implementation in release 6.0, 6.1, and early 6.5 consisted of Genesys G-Proxy, PATROL™ SNMP Master Agent, and Solution Control Server.

SNMP Option Upgrade Instructions

The following information summarizes the migration from your 6.0, 6.1, or early 6.5 SNMP implementation to the one built into Management Layer 8.0:

1. Upgrade to the latest release of SCS. See “To Upgrade the Solution Control Server” on [page 122](#) for instructions.
2. Modify the Application object you used for your PATROL™ SNMP Master Agent so that it contains the host and port of your new SNMP Master Agent. To do so, in Configuration Manager:
 - Open the SNMP Master Agent Properties window.
 - On the Server Info tab, specify the host where you plan to install and run your SNMP Master Agent.
 - On the Server Info tab, specify the port that SNMP Master Agent must use for communications with NMS.
 - On the Options tab, specify appropriate configuration options. Refer to the *Framework 8.0 Configuration Options Reference Manual* for option descriptions and the *Framework 8.0 Management Layer User’s Guide* for option-settings guidelines.

3. Install either Genesys SNMP Master Agent or a third-party SNMP master agent that is Agent-compliant. See the *Framework 8.0 Management Layer User's Guide* for installation instructions for Genesys SNMP Master Agent.
4. Update the two previous Genesys MIB files with the latest 8.0 file in your NMS. You can find the latest Genesys MIB file in the directory where SCS is installed. Refer to the *Framework 8.0 Management Layer User's Guide* for the current MIB file description and any differences from the 6.x file.

Note: Save backup copies of the previous Genesys MIB files in case of a rollback.

SNMP Option Rollback Instructions

If returning to your 6.0, 6.1, or early 6.5 SNMP installation:

1. Replace the Genesys MIB file in your NMS with the backup copies of the previously used files.
2. Change the port and host values of the SNMP Master Agent Application object in the Configuration Database. Remove any new options you have added.
3. Uninstall either Genesys SNMP Master Agent or the third-party SNMP master agent.
4. If you are not using Solution Control Server for other purposes, uninstall SCS 8.0 and reverse any configuration changes to the SCS application in the Configuration Database.
5. Start Solution Control Server 6.x.

Upgrading from 6.5

The SNMP implementation in later release 6.5 consisted of Solution Control Server and either Genesys SNMP Master Agent or a third-party Agent-compliant SNMP master agent.

SNMP Option Upgrade Instructions

The following information summarizes the migration from your 6.5 SNMP implementation to the one built into Management Layer 8.0:

1. Upgrade to the latest release of SCS. See “To Upgrade the Solution Control Server” on [page 122](#) for instructions.

2. In necessary, modify the SNMP Master Agent Properties dialog box. To do so, in Configuration Manager:
 - Open the SNMP Master Agent Properties dialog box.
 - On the Server Info tab, specify the new host where you plan to install and run your SNMP Master Agent.
 - On the Server Info tab, specify the new port that SNMP Master Agent must use for communications with NMS.
 - On the Options tab, specify appropriate configuration options. Refer to the *Framework 8.0 Configuration Options Reference Manual* for option descriptions and the *Framework 8.0 Management Layer User's Guide* for option settings guidelines.
3. If you use Genesys SNMP Master Agent, install the 8.0 release of this component. See the *Framework 8.0 Management Layer User's Guide* for installation instructions for Genesys SNMP Master Agent.
4. Update the previous Genesys MIB file with the 8.0 file in your NMS. You can find the latest Genesys MIB file in the directory where SCS is installed. Refer to the *Framework 8.0 Management Layer User's Guide* for the current MIB file description.

Note: Save a backup copy of the previous Genesys MIB file in case of a rollback.

SNMP Option Rollback Instructions

If returning to your 6.5 SNMP installation:

1. Replace the Genesys MIB file in your NMS with the backup copy of the previously used file.
2. If necessary, change the port and host values of the SNMP Master Agent Application object in the Configuration Database. Remove any new options you have added.
3. Uninstall Genesys SNMP Master Agent release 7.x.
4. If you are not using Solution Control Server for other purposes, uninstall SCS 8.0 and reverse any configuration changes to the SCS application in the Configuration Database.
5. Start Solution Control Server 6.x.



Chapter

10

Load Distribution Server Migration

The chapter in this section describes migration from release 6.5 or 7.0 to release 7.1 of Load Distribution Server (LDS). It also discusses configuration option changes in LDS release 7.0 and 7.1.

The information in this chapter contains the following topics:

- [Changes in LDS Release 7.0, page 131](#)
- [Changes in LDS Release 7.1, page 133](#)
- [Changes in LDS Release 7.2, page 133](#)
- [Prerequisites for Migration from LDS 6.5 or 7.0 to 7.x, page 134](#)
- [Installing LDS, page 134](#)
- [Configuration Option Changes from 6.5 to 7.2, page 136](#)

Changes in LDS Release 7.0

Please see the *Framework 7.0 Load Distribution Server User's Guide* for more information on these new features.

- **Licensing control:** In release 7.0, LDS installation procedures are changed to prompt the user for the location of the license file. A new configuration option, `license-file`, enables you to specify the path to the valid license file. Genesys also provides dynamic support for changes to the license file. (See *Genesys Licensing Guide* for more information.)
- **Weighted Round Robin (WRR) mode:** In release 7.0, you can configure individual Receiver applications to operate in this mode, which varies the weighting of transactions distributed to that Receiver. See “loading-coefficient” on [page 140](#).

- **New distribution modes:** In addition to normal Load Distribution mode, you can now configure LDS to operate in different distribution modes.
 - **TProxy mode:** LDS reduces the amount of data transmitted over a WAN between remote T-Servers and a number of T-Server clients in a central site. Instead of T-Servers sending the same events multiple times—once for every client—they send the events a single time to a central LDS, which then distributes this event to all clients on the central site that are registered for a particular DN. See “distribute-mode” on [page 138](#).
 - **Broadcast mode:** Events are broadcast to any client that requests them. You can use any client capable of connecting to LDS in Load Distribution mode in Broadcast mode configurations. However, you cannot mix clients for Broadcast mode and clients for one of the load distribution modes (Load Distribution mode or Single T-Server mode) on the same LDS. See “distribute-mode” on [page 138](#).
 - **Single T-Server LDS mode:** Any client can connect to LDS without modification, as long as LDS connects only to a single T-Server. See “distribute-mode” on [page 138](#).
- **Receiver grouping:** You can group Receivers using the settings in the new configuration option `group-id` to enable LDS to treat them as one Receiver. “group-id” on [page 140](#).
- **Support for additional operating system platforms:**
 - Sun Solaris 2.9, 32- and 64-bit
 - AIX5.2, 32- and 64-bit
- **Improved processing of internal statistical calculations:** In previous releases of LDS, internal statistical calculations were performed for every call in order to distribute it to the pool of Receivers. With this release, you can configure the frequency with which internal statistics are calculated (every call, every 10th call, and so on), which helps to reduce CPU loading and improve LDS performance where LDS is distributing to a large number of Receivers. See “stat-calc-threshold” on [page 139](#).
- **LDS release 7.0** requires the use of:
 - Framework 6.5 or higher—Framework 6.1 environments must be upgraded before installing LDS 7.0.
 - License Manager 7.0.

Changes in LDS Release 7.1

Please see the *Framework 7.1 Load Distribution Server User's Guide* for full information on these new features.

- **Support for Tiered TProxy mode:** In this mode LDS can be a client of another LDS that is running in TProxy mode. This enables “cascade” configurations of LDSs to be possible.
- **Support for Linux:** LDS is now available for the Red Hat Linux 3.0 platform.
- **New distribution type:** To provide more flexible support of Receivers without native High Availability, a new type of distribution has been implemented. In addition to the current support of redundant Receivers in primary/backup pairs, and the support of groups of Receivers by configuring a group ID (using configuration option `group-id`) at Receiver level, you can now choose to distribute transactions to only one Receiver in a redundant pair/group (“cluster”). Use configuration option `intra-cluster-distribution` (see “intra-cluster-distribution” on [page 139](#)) to specify this distribution type.
- **Control of passive and active Receivers:** Load Distribution Server installed in TProxy mode can now control both active and passive Receivers simultaneously.

Changes in LDS Release 7.2

Please see the *Framework 7.2 Load Distribution Server User's Guide* for full information on these new features.

- **Support for new operating systems:**
 - Red Hat Linux version 4.0
 - HP Compaq TRU64/Alfa version 5.1B
 - Solaris/Sparc 10 32/64-bit version 2.10
 - Microsoft Windows Server version Windows 2003 64-bit. Support for Windows NT is discontinued.
- **Support for rolling upgrades:** In release 7.2, when a backup LDS connects, the primary LDS marks all existing transaction as “not synchronized” and prevents the switchover request from Solution Control Interface. As soon as all marked transactions are removed, switchover becomes possible. This feature is controlled by configuration options `hardly-switchover` and `max-update-rate`—see [page 136](#) and [page 137](#).
- **Enhanced extended HA client support:** In release 7.2 a new attribute `EventSequenceId` has been implemented to improve extended HA client support.

Prerequisites for Migration from LDS 6.5 or 7.0 to 7.x

1. Install the latest release of License Manager.
2. Upgrade all 6.1 versions of the following Framework components to 6.5 or higher:
 - Configuration Server
 - DB Server
 - Configuration Manager
 - Solution Control Server

Installing LDS

This section describes the installation of LDS on UNIX/Linux and Microsoft Windows.

Installing on UNIX/ Linux

1. On the product CD, locate the appropriate shell script.
2. Run this script from the command prompt by typing the `sh` command and the file name.
3. When prompted, specify the `Host Name` of the computer on which to install LDS.
4. When prompted, specify the mode of operation (`TProxy` or `LoadDistribution`). See the *Framework 7.2 Load Distribution Server User's Guide* for full information on these operation modes.

Note: Because these modes are mutually exclusive, non-stop upgrade between different modes is not supported.

5. When prompted, specify the following:
 - `Host Name` of the computer on which Configuration Server is running.
 - `Port` client applications use to connect to Configuration Server.
 - `User Name` used to log in to the Configuration Layer.
 - `Password` used to log in to the Configuration Layer.
6. Depending on the mode selected in Step 4, installation displays the list of Applications of the relevant type configured for this host. Enter the number of the LDS Application that you want to install.
7. Specify the destination directory into which you want to install LDS, with the full path to it.
8. If asked which version of the product to install, either the 32-bit or the 64-bit, choose the one suitable for your environment.

9. When prompted, add the path to a valid license file.

As soon as the installation process is finished, a message appears announcing that installation was successful. The process places LDS in the directory you specified during the installation.

Installing on Windows

1. From the product CD, locate and double-click the appropriate `Setup.exe` to start the installation.
2. When prompted, specify the mode of operation (TProxy or LoadDistribution). See the *Framework 7.2 Load Distribution Server User Guide* for full information on these operation modes.

Note: Because these modes are mutually exclusive, non-stop upgrade between different modes is not supported.

3. When prompted, specify the Host and Port of Configuration Server. Accept ITCUtility as the name of the Installation Configuration Utility Application.
4. When prompted, specify the User Name and the Password used to log in to the Configuration Layer.
5. Confirm the Host Name of the computer on which you want to install LDS.
6. Depending on the mode selected in Step 2, installation displays the list of Applications of the relevant type configured for this host. From the list, select the LDS Application to install.
7. Specify the destination directory into which you want to install LDS.
8. When prompted, add the path to a valid license file.
9. When icons for LDS appear, click Finish to complete the installation

Note: LDS supports Configuration Server backup and Configuration Server proxy configurations.

Configuration Option Changes from 6.5 to 7.2

Table 14 describes configuration option changes between LDS 6.5 and LDS 7.2.

Table 14: LDS Option Changes Between Release 6.5 and 7.2

Current Option Name	Option Values	Type of Change	Occurred in Release	Details
LDS Section				
ha-dly-switchover	true, false	New	7.2	Determines whether the backup LDS delays switching into the Running state for Management Layer until it has been notified that target synchronization has completed. With value <i>false</i> , the backup LDS switches into Running state as soon as the backup link is established.
max-update-rate	See description	New	7.2	Defines the settings that manage the HA link load during initial transaction synchronization between the primary and backup LDSs.

Table 14: LDS Option Changes Between Release 6.5 and 7.2 (Continued)

Current Option Name	Option Values	Type of Change	Occurred in Release	Details
use-query-call	true, false	New	7.1	Specifies whether, when working with Senders with no “call-end-support,” LDS uses QueryCall to verify the existence of the call in the Sender (where supported). With value false, no QueryCall request is made to the Sender.
register-guard	0-30	New	7.1	Defines timeout between issuing an event LinkConnected (or consecutive RegisterAddress) to the client and beginning of distribution transactions to this client.
register-mode	tproxy, tserver	New	7.1	Defines TProxy behavior in processing Register Mode. Applicable for LDS in TProxy mode only.
strict-backup-name	true, false	New	7.1	With value true, LDS will not accept clients requests for connection to non-running (or passive) T-Server. With value false, (default) the feature is disabled.

Table 14: LDS Option Changes Between Release 6.5 and 7.2 (Continued)

Current Option Name	Option Values	Type of Change	Occurred in Release	Details
active-context-limit		New default value and valid values	7.1	Default value changed from 100000 to 1000000. Upper limit of valid values changed to 1000000.
context-cleanup		New default value and valid values	7.1	Default value changed from 5 to 30. Lower limit of valid values changed from 5 to 15.
background-processing	true, false	New	7.0	When enabled, LDS processes all switch messages immediately and delays the message queue associated with all LDS client requests until there are no switch messages.
background-timeout	Any integer	New	7.0	Specifies the time to pause in milliseconds before processing client requests in background mode.
distribute-mode	auto, load, proxy	New	7.0	<p>auto—LDS selects its own mode depending on the actual configuration.</p> <p>load—LDS is forced into Load Distribution mode.</p> <p>proxy—LDS acts as proxy between T-Server and client.</p>

Table 14: LDS Option Changes Between Release 6.5 and 7.2 (Continued)

Current Option Name	Option Values	Type of Change	Occurred in Release	Details
intra-cluster-distribution	all, one	New	7.0/7.1	Specifies whether to distribute transactions to one Receiver in a cluster (value set to one), or all Receivers (value set to all). If a nominated Receiver in such a configuration fails, LDS distributes subsequent transactions to the other/next Receiver as per Warm Standby (no synchronization).
stat-calc-threshold	0–100	New	7.0	Specifies the frequency with which LDS recalculates internal statistics to sort available Receivers according to their loading.
license-file	Valid path to license file	New	7.0	If the license file location is not specified on startup (using the -l command-line parameter), LDS uses the value specified in this option as the location for license file from which to obtain the license.

Table 14: LDS Option Changes Between Release 6.5 and 7.2 (Continued)

Current Option Name	Option Values	Type of Change	Occurred in Release	Details
query-timer	2–60	New	6.5.3	Defines the time (in minutes) between the receipt of the last event for an active transaction and an LDS query to T-Server to check if the call still exists.
LDS Section of Receiver Application				
group-id	0–65535	New	7.0	Allows grouping of Receiver applications. Groups are treated as one Receiver.
loading-coefficient	0–100	New	7.0	Specifies Receiver's weighting for WRR mode.



Chapter

11

Stat Server Migration

This chapter describes migration to release 8.x of Stat Server from earlier releases, beginning with release 6.5. It also discusses changes in Stat Server behavior and configuration throughout the releases. The latest available release of Stat Server is 8.0.

This chapter contains the following sections:

- [Preliminary Migration Instructions, page 141](#)
- [Compatibility with Framework Components, page 142](#)
- [Stat Server 8.x General Changes, page 142](#)
- [Stat Server 7.x General Changes, page 143](#)
- [Configuration Option Changes, page 147](#)
- [Migrating to 8.x, page 156](#)

Preliminary Migration Instructions

Note: If you want to upgrade your operating system, you must do so before you migrate Stat Server.

Before you migrate your version of Stat Server to release 8.x, review the following sections:

- “Stat Server 8.x General Changes” on [page 142](#)
- “Configuration Option Changes” on [page 147](#)

Licensing Requirements

Beginning with release 7.0 of Stat Server, you do not require a license to use Stat Server. Releases of Stat Server earlier than 7.0 did require a license.

Compatibility with Framework Components

Stat Server 8.x interoperates successfully with the following Framework components:

- Configuration Server, releases 6.1 through 8.0
- Local Control Agent, releases 6.1 through 8.0
- Message Server, releases 6.1 through 8.0
- DB Server, releases 6.1 through 8.0
- T-Server, release 6.1 through 8.0
- Solution Control Server, release 6.1 through 8.0

However, to access all of the features that are available in a particular release, Genesys recommends that you operate Stat Server within the same family of Framework components in which it was released, or the latest available component release. Otherwise, some documented features may not be available to you.

Stat Server 8.x General Changes

This section describes major enhancements in Stat Server functionality since release 7.6.

- The addition of source timestamps to the Stat Server statistics profile, to provide better synchronization with Interaction Concentrator.
- Support for secure Transport Layer Security connections to Stat Server's clients and servers. Refer to "Introduction to Genesys Transport Layer Security" in the *Genesys 8.0 Security Deployment Guide* for more information.
- Storage of an interaction's ID in a new column of the STATUS table, along with the database initialization scripts to create this table. This functionality is available for all supported RDBMSs except Informix.
- Filter improvements
- Improvement in Stat Server's detection and clearing of stuck calls on virtual queue objects.
- Improvement in the calculation of LoadBalance statistics by enabling you to set the initial value for average handling time.
- Support for operating Outbound Contact from a SIP-controlled telephony server.

- Support for creating a Stat Server application using Genesys Administrator. Refer to *Genesys Administrator Help* for general instructions on how to use the provided XML template to configure a Stat Server 8.0 application.
- Enhancements to the methodology for Stat Server's generation of CallAnswered actions on virtual queue objects, and the addition of a few configuration options to control Stat Server behavior.
- The introduction of the *current agent* concept on Place objects.
- The introduction of limited reporting for workbin objects. Refer to the descriptions of the CallWait, CallEntered, and CallDistributed mediation DN actions in the *Framework 8.0 Stat Server User's Guide* for more information.

Stat Server 7.x General Changes

This section describes major enhancements in Stat Server functionality since release 6.5.

Stat Server Supports SSJEs

Starting with the release 7.0 of Stat Server, some statistics for Multimedia (formerly known as Multi-Channel Routing, or MCR) require that specific Stat Server Java Extensions (SSJEs)—`eServiceContactStat.jar`, `eServiceInteractionStat.jar`, and `eServiceSystemStat.jar`—be configured in Stat Server. Likewise, some statistics for the Voice Callback option of Enterprise Routing require the `VCBStatExtension.jar` Java extension. Stat Server release 7.0.3 is the first release to support these extensions.

Starting with release 7.2 of Outbound Contact, some statistics for Outbound Contact required the `OCCStatExtension.jar` Java extension. Stat Server supports the `eServiceSystemStat.jar` and `OCCStatExtension.jar` Java extensions starting with release 7.2.

These extensions are automatically deployed and configured under either of the following conditions:

- You install Stat Server from the Real-Time Metrics Engine CD.
- You configure or upgrade your Stat Server Application object to release 7.0.3 (or higher) by using the Stat Server Wizard.

To generate open-media data, your Stat Server release must be 7.1 or higher, and you must install the MCR Extensions.

If you configure Stat Server manually, you will have to run separate installations for Outbound Contact Extension, MCR Extension, and/or Voice Callback Extension. Then, you will have to update your Stat Server Application object to configure one or more of the following:

- One Outbound Contact Extension
- Three MCR Extensions
- One VCB Extension

Also, you must configure Extension- and JVM-related options.

Under these circumstances, you must ensure the following:

- You have set the `enable-java` Stat Server configuration option to `TRUE` in the `statserver` configuration section.
- For Outbound Contact, you have created the `OCCStatExtension.jar` configuration option in the `java-extensions` section and set its value to `TRUE`.
- For Multimedia, you have created the `eServiceContactStat.jar`, `eServiceInteractionStat.jar`, and `eServiceSystemStat.jar` configuration options in the `java-extensions` section and set their values to `TRUE`.
- For Voice Callback (VCB), you have created the `VCBStatExtension.jar` configuration option in the `java-extensions` section and set its value to `TRUE`.
- You have configured the `java-config` section including the correct path to your Java Runtime Environment that you must specify in the `java-path` configuration option in this section.
- You have added your Stat Server application to the `Connection` tabs of your appropriate servers, such as Universal Contact Server, Interaction Server, Outbound Contact Server, and Voice Callback Server.

Refer to the *Framework Stat Server Deployment Guide* for installation instructions, as well as additional information about these and other Java-related configuration options and sections. Likewise, if you upgrade Stat Server manually, you must also upgrade the extensions manually to access new statistical definitions that are included therein.

Starting with release 7.5 of Stat Server, Java Runtime Environment 1.4 is the minimum required version to operate Stat Server successfully.

Changes to Seven VCB Metrics

To enable the count of callback requests initiated from a Web interface within VCB reports (in addition to those that are initiated from a telephone), the definitions of seven metrics were changed in the `Callback Operation` report that is derived from the VCB Stat Server Java Extension. Those metrics are the following:

- | | |
|----------------------------|-----------------|
| • CB Request Attempts | • Successful CB |
| • ASAP CB Requested | • Made |
| • Scheduled CB Requested | • Succeeded |
| • Last Hour (CB Requested) | |

The preceding changes occurred in release 7.1 of Stat Server.

Backward Compatibility Provided for ICS in Multimedia

Even though Internet Contact (ICS) 6.5 and Multimedia 7.x are very different Genesys solutions, Stat Server does provide some level of backward compatibility for reporting clients in regards to multimedia statistics. But there are some exceptions:

- The Multimedia solution does not provide the ability to report on virtual route points, whereas in ICS, such functionality is reportable.

The Multimedia solution does not allow you to report on Multimedia-bounded route points. As a result, this solution is unable to request statistics for Multimedia-controlled virtual route points.

- You cannot use the `CallAnswered` or `CallReleased` masks in statistics that measure activity for nonvoice interactions that stem from a Multimedia virtual queue.

Discontinuation of Statistical Category

The `EstimateToEndCurrentNumber` statistical category has been discontinued as of release 7.0. This category was previously used in some CCPulse+ templates to calculate the estimated amount of time it took for interactions to be distributed (or abandoned) from a particular queue, routing point, or queue group.

Resource Capacity Model

Release 7.0.2 of Stat Server introduced the resource capacity model to better manage agent workload and interaction delivery, especially in a multi-channelled environment.

Stat Server 7.6 introduces support for a new type of DN—a multimedia DN—which is controlled by SIP T-Server. The addition of this multimedia DN to a Genesys contact center environment enhances the resource capacity model by enabling URS to route more than one simultaneous interaction to a single instance of this DN type. Some previously existing action types, when generated at these DNs, are now treated as media-specific actions, so multiple simultaneously present instances of each such action type are allowed on multi-media DNs (one action instance per media). Chapters 1 and 6 of the *Genesys 7.6 Resource Capacity Planning Guide* describe this new functionality. The *Framework 7.6 Stat Server User's Guide* describes the new actions that are introduced in this release to support multimedia DN functionality.

Stat Server Database Changes

Release 7.2 of Stat Server generates new data for releases 7.2 and higher of Genesys Info Mart, and introduces the `VOICE_REASONS` table for storing agent reasons for being in the `Ready`, `NotReady`, and `AfterCallWork` states for voice interactions.

In release 7.1 of Stat Server, the values that are stored in three fields changed from those that were stored in previous releases:

- `ConnID` fields of both the `QINFO` and the `STATUS` tables
- `Status` field of the `QINFO` table

ConnID Fields: Starting with release 7.1, Stat Server now stores the first transfer connection ID in the `ConnID` field of the `QINFO` and `STATUS` tables—instead of the current connection ID—in multisite scenarios in which the first transfer connection ID differs from the current connection ID that is associated with the call.

Status Field: Starting with release 7.1, Stat Server may send one of two new values to the `Status` field of the `QINFO` table to accommodate its recognition of

stuck calls that have been cleared in T-Server. A value of 8 indicates that a call was cleared after being stuck on a distribution DN. A value of 9 indicates that a call was cleared after being stuck while ringing at the DN of an agent.

And, in Stat Server 7.6, the values stored in two fields of the LOGIN table (DNDBID and LOGINID) were expanded to recognize multimedia:

- **DNDBID Field:** Stat Server stores 0 (zero) in this field if the agent logs in to or off from a media channel.
- **LOGINID Field:** Stat Server stores the media type in this field where an agent has logged in to or off from a media channel.

Refer to the *Stat Server Deployment Guide* for further details and the meaning of other values.

Log Events Each 7.x release of Stat Server has introduced improvements in the logging of server-related events. The 7.6 release of Genesys introduces user-designated levels for Stat Server 7.6 log events by way of the `level-reassign-<eventID>` configuration option—enabling you to control which events Stat Server classifies as Standard, Trace, or Debug in its log. Refer to the *Stat Server Deployment Guide* for information on how to reassign a default log event level.

Algorithm Changes This section describes some of the algorithm changes that were implemented between Stat Server releases 6.5 and 7.x of Stat Server.

- Starting with release 7.0.1 of Stat Server, `AverageOfCurrentNumber/Time` statistics no longer skip the first current value as was the case with previous implementations of Stat Server. The new algorithm is described in detail in the “Statistical Categories” chapter of the *Stat Server User’s Guide*.
- Starting with release 7.0.1, Stat Server uses an enhanced procedure for determining the values of filtered statistics. Refer to the “Filters Section” of the “Statistic Configuration Options” chapter of the *Stat Server User’s Guide* for details and examples.
- Starting with release 7.0.1, Stat Server increments `CallReleased` on queue statistics if a transfer is completed immediately after Stat Server receives `EventEstablished`.
- Starting with release 7.0.1 of Stat Server, both `ACWCompleted` and `AfterCallWork` actions begin after call release, for all switch types. Refer to the “Stat Server Actions” chapter of the *Stat Server User’s Guide* for details.
- Releases 7.0.1 and higher of Stat Server, register empty agent and place groups with `Monitored` status. This feature has a positive affect on routing strategies that are used in Genesys Enterprise Routing.
- Regular statistics (those that are based on actions or statuses) no longer are affected by the enabling or disabling of statistical objects in release 7.0.1 of Stat Server. For example, disabling an agent in his or her group does not affect the statistics of his or her agent group. Only current-state statistics are affected by the enabling or disabling of objects.

- Release 7.0.2 of Stat Server introduces five new `CallDistributedToQueue...` actions that are generated when an interaction is distributed from one distribution DN to another (or the same) distribution DN.
- Release 7.0.2 of Stat Server introduces several new actions for enabling more detailed reporting for consult and internal calls by separating initiated and received calls, if needed—for example, `CallInternalOriginated` and `CallInternalReceived`.
- Release 7.5 of Stat Server expands the versatility of filters by enabling you to use wild-card characters in the `PairExists` function.
- Release 7.5 of Stat Server introduces the `CurrentContinuousTime` statistical category and the `CallConferenceOriginated` action.
- Release 7.5 of Stat Server enables you to use the logged in status of switches as a parameter for determining the composition of virtual agent group membership.
- Release 7.5 of Stat Server checks for and removes stuck calls on virtual queues.
- Release 7.6 of Stat Server improves propagation of `CallAnswered` statistics for virtual queue objects in multi-site environments when the `use-data-from T-Server` configuration option is set to `original`.
- Stat Server release 7.6 enables you to apply `DCID` to durable, call-related `TotalTime` statistics.
- In the 7.6 release, Stat Server calculates the status of Extension DNs differently for events originating from a SIP Server multimedia DN (where the `multimedia` configuration option has been set to `TRUE`) as Stat Server calculates such events originating from a nonSIP compliant T-Server Extension DN.

Configuration Option Changes

Tables 15 through 22 document the changes in Stat Server configuration from releases 6.0 through 8.0 of Stat Server. For a complete listing and description of all configuration options that Stat Server currently supports, refer to the “Fine-Tuning Stat Server Configuration” chapter in the *Framework 8.0 Stat Server Deployment Guide* and the “Statistic Configuration Options” chapter in the *Framework 8.0 Stat Server User’s Guide*.

Stat Server also supports common log options. Refer to Table 3, “Common Option Changes,” on [page 100](#) for information about these changes.

Table 15: Option Changes in Stat Server 8.0

Current Option Name	Type of Change	Release # in Which Change Occurred	Details
statsserver Section			
allow-vq-orig-dns-from-environment	Added	8.0	Specifies whether Stat Server generates CallAnswered and associated actions to virtual queue origination DN objects that belong to the Environment tenant.
check-vq-stuck-calls-frequency	Added	8.0	Specifies the frequency with which Stat Server checks virtual queues for stuck calls. Prior to the introduction of this option, this functionality was internally hardcoded at 60 seconds. The default in the 8.0 release is 600 seconds.
ixn-id-in-status-table	Added	8.0	Specifies whether Stat Server will populate the IxnID field in the STATUS table.
load-balance-aht	Added	8.0	Specifies the initial value for the average handling time for interactions distributed from mediation DN's. This value is used by the LoadBalance statistical category.
queue-use-pseudo-actions	Added	8.0	Enables the use of pseudo-actions on mediation DN's.
suppress-user-data	Added	8.0	Configured on the Annex tab of switch and/or DN objects to suppress Stat Server from transmitting call-extracted attached data to clients.
vq-ignore-third-party-dn	Added	8.0	Controls whether Stat Server relies on the ThirdPartyDN attribute of EventDiverted TEvents to determine the DN to which a call was diverted from a given virtual queue.
vq-treat-unknown-third-party-dn-as-agent-dn	Added	8.0	Controls whether Stat Server references the value of the ThirdPartyDN attribute in EventDiverted TEvents to determine the location to which the call was diverted from a virtual queue for generation of CallAnswered. If ThirdPartyDN points to a DN that is unknown to Stat Server and this option is set to yes, Stat Server considers this unknown DN to be an agent DN.

Table 15: Option Changes in Stat Server 8.0 (Continued)

Current Option Name	Type of Change	Release # in Which Change Occurred	Details
[stat type] Section			
UseSourceTimeStamps	Added	8.0	Enables you to control whether Stat Server uses local timestamps or source timestamps (from the event-supplying server) in its calculation of time-based statistics.

Table 16: Option Changes in Stat Server 7.6

Current Option Name	Type of Change	Release # in Which Change Occurred	Details
statsserver Section			
capacity-treat-acw-as-interaction	Added	7.6	Enables Stat Server to calculate the capacity vector differently in determining the capacity of associated place or agent by considering ACW associated with voice interactions.
debug-level	Changed	7.6	The <code>Client</code> option was changed to exclude <code>StatValid/StatInvalid</code> messages among the communications that are logged.
	Added	7.6	<code>ClientX</code> is a new value that you can use for Stat Server to log <code>StatValid/StatInvalid</code> messages and to exclude logging of other statistic-related communications.
max-unsent-sql-statements	Added	7.6	Controls the number of SQL statements that Stat Server is allowed to maintain in memory.
multimedia-activity-in-status-table	Added	7.6	Controls whether multimedia activity is stored in the <code>STATUS</code> table.

Table 16: Option Changes in Stat Server 7.6 (Continued)

Current Option Name	Type of Change	Release # in Which Change Occurred	Details
suppress-agent-status-updates-for-ixn-server	Added	7.6	Suppresses Stat Server from sending Event CurrentAgentStatus notifications to Interaction Server and other clients.
warn-unsent-sql-statements	Added	7.6	Defines a threshold upon which Stat Server begins to log warning messages about the high number of SQL statements that currently are being stored in memory.

Table 17: Option Changes in Stat Server 7.5

Current Option Name	Type of Change	Release # in Which Change Occurred	Details
statsserver Section			
do-backup-in-background	Added	7.5	Enables Stat Server to spawn a separate thread for storing statistic definitions in its backup file.
filters-allow-wildcards-in-values	Added	7.5	Enables Stat Server to accept wild-card characters in the <value> argument of PairExist functions in filters.

Table 18: Option Changes in Stat Server 7.2

Current Option Name	Type of Change	Release # in Which Change Occurred	Details
statsserver Section			
accept-clients-in-backup-mode	Added	7.2	Enables Stat Server to accept client connections when it operates in backup mode.
ignore-disabled-objects-in-group-statistics	Added	7.2	Specifies if group statistics account for Person and Place objects that are disabled in configuration.

Table 18: Option Changes in Stat Server 7.2 (Continued)

Current Option Name	Type of Change	Release # in Which Change Occurred	Details
ignore-disabled-objects-in-queue-statistics	Added	7.2	Specifies if queue statistics account for Person and Place objects that are disabled in configuration.
NEC-position-extension-linked	Added	7.2	Engages a special model for processing ACW-related (after-call work) events from NEC T-Server.
position-extension-linked	Added	7.2	Affects Stat Server interpretation of the place status when the place contains a position and an extension that belong to the same switch.
reg-dns-chunk-delay	Added	7.2	In conjunction with reg-dns-chunk-volume, helps Stat Server to optimize DN registration at startup.
reg-dns-chunk-volume	Added	7.2	In conjunction with reg-dns-chunk-delay, helps Stat Server to optimize DN registration at startup.
send-timeout	Added	7.2	Prevents Stat Server from disconnecting slow clients.
voice-reasons-table	Added	7.2	Enables Stat Server to populate the VOICE_REASONS table.

Table 19: Option Changes in Stat Server 7.1

Current Option Name	Type of Change	Release # in Which Change Occurred	Details
statserver Section			
max-client-connections	Added	7.1	Added to limit the number of clients that can be connected to Stat Server at any given time.
status-table-update-end-time-at-end-only	Added	7.1	Prevents Stat Server from recording a status end time until the status completes.
vag-statistics-active-agents-only	Added	7.1	Limits membership of virtual agent groups to only those active agents that satisfy a particular script condition.

Table 19: Option Changes in Stat Server 7.1 (Continued)

Current Option Name	Type of Change	Release # in Which Change Occurred	Details
[stat type] Section			
MediaType	Added	7.1	To further restrict the values that Stat Server returns to its clients by way of a specified media type.

Table 20: Option Changes in Stat Server 7.0

Current Option Name	Type of Change	Release # in Which Change Occurred	Details
statserver Section			
auto-backup-interval	Renamed	7.0	Original name was AutoBackupInterval.
backup-file-name	Renamed	7.0	Original name was BackupFileName.
binding-threshold	Renamed	7.0	Original name was OracleBindingThreshold.
check-stuck-calls	Renamed	7.0	Original name was CheckStuckCalls.
CurrentStateDelta	Removed	7.0	Stat Server now dynamically chooses the optimal method for propagation, making this option obsolete.
debug-level	Renamed	7.0	Original name was DebugLevel.
	Added	7.0.1	Mngmnt is a new value that you can use with this configuration option.
DefaultGroupSPT	Removed	7.0	
emulate-acw-for-mlink	Renamed	7.0	Original name was EmulateACWForMLink. This configuration option no longer is necessary for Stat Server 7.0 if the MLink T-Server also is release 7.0. Please be sure to turn this option off after T-Server upgrade.
enable-binding	Renamed	7.0	Original name was OracleBinding. This option now supports binding for Microsoft SQL relational database as well as Oracle.

Table 20: Option Changes in Stat Server 7.0 (Continued)

Current Option Name	Type of Change	Release # in Which Change Occurred	Details
enable-java	Added	7.0.2	Enables Stat Server to read stat type definitions from Java extension jar archives.
ignore-off-hook-on-position	Renamed	7.0	Original name was IgnoreOffHookOnPosition.
local-time-in-status-table	Renamed	7.0	Original name was LocalTimeInStatusTable.
login-table	Renamed	7.0	Original name was LoginTable.
old-stats-remove-interval	Renamed	7.0	Original name was OldStatsRemoveInterval.
QInfoTable	Renamed	7.0	Original name was qinfo-table.
reconnect-timeout	Renamed	7.0	Original name was reconnect_timeout. All Stat Server connections are now nonblocking.
reg-delay	Renamed	7.0	Original name was reg_delay.
reset-status-on-reason	Renamed	7.0	Original name was ResetStatusOnReason.
status-table	Renamed	7.0	Original name was StatusTable.
time-format	Renamed	7.0	Original name was TimeFormat.
use-original-connid	Removed	7.0.2	Original name was use_original_connid.
use-server-id	Renamed	7.0	Original name was UseServerID.
java-config Section			
java-config section	Added	7.0.2	Specifies the path to where all Java extensions are stored.
java-extension-loading-timeout	Added	7.0.2	Specifies the amount of time that Stat Server allocates for the loading of Java extensions.
java-extensions-dir	Added	7.0.2	Specifies the path to where all Java extensions are stored.
java-libraries-dir	Added	7.0.2	Specifies the path to where all Java libraries are stored.
jvm-path	Added	7.0.2	Specifies the path to the Java Virtual Machine (JVM).

Table 20: Option Changes in Stat Server 7.0 (Continued)

Current Option Name	Type of Change	Release # in Which Change Occurred	Details
java-extensions Section			
java-extensions section	Added	7.0.2	New section that lists the Java Extensions that Stat Server loads.
<filename>.jar	Added	7.0.2	Specifies if Stat Server should load the Java Extension that is indicated by the name of the option.
jvm-options Section			
jvm-options section	Added	7.0.2	New section that enables you to configure options for storing command-line options that are specific to your JVM. For Solaris platforms, if HotSpot JVM is used, Genesys recommends that you set an option for the <code>-XX:ThreadStackSize</code> command-line parameter to 4096 to guarantee sufficient stack size.
[stat type] Section			
<i>new sections</i>	Added	7.0	The following two new stat-type options were added to support Java stat types: <ul style="list-style-type: none"> • <code>AggregationType</code> • <code>JavaSubcategory</code> Note: <code>AggregationType</code> functionality is available through CC Analyzer Data Sourcer.

Table 21: Option Changes in Stat Server 6.5

Current Option Name	Type of Change	Release # in Which Change Occurred	Details
statsserver Section			
CurrentStateDelta	Added	6.5	

Table 21: Option Changes in Stat Server 6.5 (Continued)

Current Option Name	Type of Change	Release # in Which Change Occurred	Details
EmulateACWForMLink	Added	6.5	Enables StatServer support for the ACW implementation in T-Server for the Nortel Meridian 1 switch.
OracleBinding	Added	6.5	Added to support database binding for Oracle RDMBSs and achieve improved performance.
OracleBindingThreshold	Added	6.5	Added to support database binding for Oracle RDMBSs.

Table 22: Option Changes in Stat Server 6.1

Current Option Name	Type of Change	Release # in Which Change Occurred	Details
statserver Section			
use_original_connid	Added	6.1.009.01	

Table 23: Option Changes in Stat Server 6.0

Current Option Name	Type of Change	Release # in Which Change Occurred	Details
statserver Section			
log-buffering	Removed	6.0	Replaced with common log options.
log-check-interval	Removed	6.0	Replaced with common log options.
log-file-name	Removed	6.0	Replaced with common log options.
log-file-size	Removed	6.0	Replaced with common log options.
log-remove-old-files	Removed	6.0	Replaced with common log options.
verbose	Removed	6.0	Replaced with common log options.

Migrating to 8.x

Upgrading Stat Server

To migrate to any 8.x release of Stat Server, you must do both of the following:

1. Upgrade the Stat Server `Application` object.
2. Upgrade the Stat Server application by installing the latest Stat Server executable file.

You can run the Stat Server Wizard in Upgrade mode to both upgrade your `Application` object and deploy an installation package, or you can perform the upgrade manually. Both methods are described in the “Configuring Stat Server” chapter of the *Framework 8.0 Stat Server Deployment Guide*.

Updating an Existing Stat Server Database

The 8.0 release introduces a new column (`IxnID`) in the `STATUS` table for storing interaction IDs generated from Interaction Server. Your database administrator can manually add the `IxnID` field to your Stat Server database using attributes from the appropriate database initialization script provided with the 8.0 release. As a precaution, always back up your database before making structural changes to it.

Warning! Do not run the initialization scripts against an existing Stat Server database. The scripts drop all tables before creating them anew and all stored data will be lost if you do.

Note that Stat Server does not populate this field for Informix RDBMSs.

In conjunction with the structural database changes, set the appropriate Stat Server configuration options to populate this field. Review the `ixn-id-in-status-table` and `multimedia-activity-in-status-table` configuration options described in the *Framework 8.0 Stat Server Deployment Guide*, and set them appropriately in the `[statserver]` section of your Stat Server `Application` object using Configuration Manager.

Implementing Other Configuration Updates

If you have not previously used the alarm-signaling capabilities of the Management Layer, or if you want to make some adjustments, configure or update the following objects after performing Stat Server migration:

- Alarm Conditions
- Alarm Reactions

Review the recent changes to common log events and Stat Server–specific log events that are listed in *Genesys Combined Log Events Help*. Verify that your Alarm Condition and Alarm Reaction objects are based on currently supported log events. If necessary, make appropriate changes or configure new alarm conditions for newly-introduced log events.

Note: Use Management Layer wizards that are available in SCI to update or configure alarm conditions and alarm reactions. Refer to *Framework 8.0 Solution Control Interface Help* and the *Framework 8.0 Management Layer User's Guide* for more information.

If you have not previously used the centralized-logging and alarm-signaling capabilities of the Management Layer, but would you like to do so now, add a connection to the Message Server on the `Connections` tab of the Stat Server `Application` object in the Configuration Manager. Do this after you have configured `Application` objects for the Management Layer components.

If you are using the Configuration Server Proxy to notify this Stat Server about configuration changes, add the Configuration Server Proxy to the `Connections` tab of the Stat Server `Application` object in the Configuration Manager. Do this after you have configured an `Application` object for the Configuration Server Proxy.

Rolling Back Stat Server

Rolling back Stat Server to an earlier release is more effective if you possess the export of your original configuration, as recommended in the *Deployment Guide*.

1. Stop Stat Server.
2. In Configuration Manager, re-import the `*.cfg` or `*.conf` file from your original environment. *Framework Configuration Manager Help* describes how to use the Import utility.
3. Delete any new connections to server applications that you have configured on the `Connections` tab of the Stat Server `Application` object in the Configuration Manager.
4. Uninstall the undesired release of Stat Server 8.x.
5. Reinstall the desired, earlier release of Stat Server.
6. Start Stat Server and check its log to verify proper operation.



Chapter

12

Integration Server and Software Development Kits Migration

These migration procedures explain how to upgrade from version 6.1, 6.5.0, 6.5.1, or 7.x to version 7.0, 7.1, 7.2, 7.5 or 7.6, of Genesys Integration Server (GIS) and related Software Development Kits (SDKs).

In the 6.1 release, this product was named the *Gplus* Foundation Real-Time Statistics API. In the 6.5.x through 7.1 releases, it was named the Genesys Developer Program Framework SDK, and its GIS component was named Genesys Interface Server.

Beginning with the 7.2 release, GIS has been renamed the Genesys Integration Server, and it combines the features of the former GIS 7.1 and Genesys .NET Server 7.1.

GIS presents APIs for five services: Session Service, Statistics Service, Configuration Service, Agent Interaction services, and Open Media Interaction services. The Session Service provides login, logout, and licensing functionality, serving all the other GIS-based APIs. The Configuration and Session APIs were added in release 6.5.1. The Agent Interaction services were added in release 7.0, and the Open Media Interaction services in release 7.1. Certain code examples and documentation, together with GIS, make up the Statistics and Configuration SDKs.

Warning! The 7.x releases do *not* include the 6.1/6.5.0 Statistics API. If you are migrating from 6.1/6.5.0, you will need to make substantial changes to your client application to conform to the new Statistics API. This migration chapter includes references to code examples that illustrate the differences. For further information, see “6.1 and 6.5.0 to 7.x Statistics API” on [page 171](#).

This chapter covers the following topics:

- [Overview, page 160](#)
- [Genesys Integration Server with Custom Clients, page 161](#)
- [System Requirements for 7.2 \(or later\), page 162](#)
- [System Requirements for 7.1, page 162](#)
- [System Requirements for 7.0, page 163](#)
- [GIS Migration 7.5 to 7.6, page 163](#)
- [GIS Migration 7.2 to 7.5 \(or later\), page 163](#)
- [GIS Migration 7.0 or 7.1 to 7.2 \(or later\), page 164](#)
- [GIS Migration 6.5.1 to 7.x, page 165](#)
- [GIS Migration 6.1 or 6.5.0 to 7.x, page 166](#)
- [Changes to GIS Application Options, page 166](#)
- [Changes to Error Messages 6.5.1 to 7.x, page 168](#)
- [6.1 and 6.5.0 to 7.x Statistics API, page 171](#)
- [Changes to Statistics API Methods from 6.1 and 6.5.0 to 7.x, page 172](#)
- [6.5.1 to 7.x Configuration API, page 177](#)

Overview

Migration from a prior version of this product to a 7.x release includes the following major steps:

- Migration Steps**
1. Install the new version of GIS.
 2. Make any necessary changes to the configuration options for the GIS application.
 3. Update your client application to take advantage of new methods for retrieving statistical and configuration information.
 4. Update your licensing (in migration scenarios where this is necessary) by doing either or both of the following:
 - Install an updated version of License Manager.
 - Copy feature items from multiple existing license files into a single new license file for given host. (This process is described in the *Genesys Licensing Guide*.)

This chapter details the changes made to configuration options in GIS 7.x. It also summarizes changes to certain methods used with the Statistics, Session, and Configuration APIs. However, because client application development is always customized, this chapter generally provides no specific instructions for rewriting your client application to take advantage of the new functionality.

This chapter does include some commentary, and pointers to useful code examples, to assist users migrating from the 6.1/6.5.0 Statistics API to the current Statistics API.

This chapter should be used together with the your current version of the *Genesys Integration Server Deployment Guide* (or, if you are migrating to version 7.0 or 7.1, the *Genesys Developer Program 7.1 Genesys Interface Server Deployment Guide*).

The *Deployment Guide* contains full configuration and installation instructions for GIS 7.x, including instructions for new configuration options added in versions 7.x.

Genesys Integration Server with Custom Clients

[Table 24](#) identifies the compatibility of Genesys Integration Server (GIS) with clients built for integration with it.

7.2 or Later Libraries with GIS 7.1 or .NET Server 7.1

Applications built with 7.2 or later libraries are not backward-compatible with Genesys Interface Server 7.1 or .NET Server 7.1.

GIS 7.2 and GIS 7.5

Genesys Integration Server 7.2 and 7.5 are made of two connectors from which the customer must choose at installation time: GIS SOAP and GIS GSAP.

- GIS SOAP and GIS GSAP respectively are provided to replace the former GIS and .NET Server.
- GIS SOAP installed with the former GIS, and GIS GSAP installed with the former .NET Server behave like GIS and .NET Server, respectively, and can work with 7.1 or later proxies.

GIS 7.2 and GIS 7.5 Proxies

The 7.2 and 7.5 proxies are backward-compatible on the interface level with the 7.1 proxies, so that client applications coded with the 7.1 proxies continue to work with the 7.2 and 7.5 proxies.

However, the 7.2 and 7.5 proxies are not backward-compatible on the protocol level; they are intended for use with GIS 7.2 and 7.5 servers only, not with GIS 7.1 servers.

Table 24 shows 7.x GIS and Client Compatibility.

Table 24: GIS-Client Compatibility

GIS Version	Connector	Prop Protocol			SOAP		
		Proxy 7.1	Proxy 7.2	Proxy 7.5	Proxy 7.1	Proxy 7.2	Proxy 7.5
7.1	.NET Svr	yes	no ^a	no ^a	N/A		
	GIS	N/A			yes	no	no
7.2	GIS GSAP	yes ^b	yes	yes	N/A		
	GIS SOAP	N/A			yes ^b	yes	no
7.5	GIS GSAP	yes ^b	yes	yes	N/A		
	GIS SOAP	N/A			yes ^b	yes	yes

a. Protocol reason.

b. New 7.2 and 7.5 functionality will not be accessible in this combination. You will need to perform some development on the customer application. In order to gain access to GIS features that are available only after the initial 7.1 release, for instance, new methods, you need to use GIS: Proxies that correspond to that later GIS release. In fact, this rule applies in all cases where the GIS version is higher than the proxy version being used for a client. (See GIS Release Notes for more details.)

System Requirements for 7.2 (or later)

For hardware and software requirements for the GIS server, the *Genesys Supported Operating Environment Reference Manual*, which can be found on the Genesys Technical Support website.

For supported development tools, see the corresponding version of the *Genesys Integration Server 7.x Deployment Guide*.

System Requirements for 7.1

For hardware and software requirements for the GIS server, the *Genesys Supported Operating Environment Reference Manual*, which can be found on the Genesys Technical Support website.

For supported development tools, see the *Genesys Developer Program 7.1 Genesys Interface Server Deployment Guide*.

System Requirements for 7.0

For hardware and software requirements for the GIS server, see the *Genesys Supported Operating Environment Reference Manual*, which can be found on the Genesys Technical Support website.

For supported development tools, see the *Genesys Developer Program 7 Genesys Interface Server Deployment Guide*.

GIS Migration 7.5 to 7.6

If you are upgrading from GIS 7.5, you can install Genesys Integration Server 7.6:

- As a maintenance upgrade for GIS 7.5.

In this case, you keep your existing 7.5 Configuration Layer application, and point to it when running the GIS 7.6 installation package. Select the GIS 7.6 installation type that matches your 7.5 product: SOAP Standalone, SOAP Web Module, or GSAP.

This migration procedure will create an instance of GIS 7.6 with the same level of functionality as its 7.5 predecessor. See the *Genesys 7 Interoperability Guide* for information on the compatibility of Genesys products with various Configuration Layer Environments; Interoperability of Reporting Templates and Solutions; and *Gplus* Adapters Interoperability.

- To implement new 7.6 features.

First, install a GIS 7.6 application template, then a new application based on that template. Finally, run the GIS 7.6 installation package, selecting the connector type (SOAP Standalone, SOAP Web Module, or GSAP) that matches your 7.6 product. For details, see the *Genesys Integration Server 7.6 Deployment Guide*.

Note: To implement new 7.6 features, you can keep your existing 7.5 Configuration Layer application. Deleting it is optional.

GIS Migration 7.2 to 7.5 (or later)

If you are upgrading from GIS 7.2, you can install Genesys Integration Server 7.2 for either of two purposes:

- As a maintenance upgrade for GIS 7.2.

In this case, you keep your existing 7.2 Configuration Layer application, and point to it when running the GIS 7.5 installation package. Select the

GIS 7.5 installation type that matches your 7.2 product: SOAP Standalone, SOAP Web Module, or GSAP.

Under this migration path, GIS 7.5 will provide the same level of functionality as its 7.2 predecessor. See the *Genesys 7 Interoperability Guide* for information on the compatibility of Genesys products with various Configuration Layer Environments; Interoperability of Reporting Templates and Solutions; and *Gplus* Adapters Interoperability.

- To implement new 7.5 features.

First, install a GIS 7.5 application template, then a new application based on that template. Finally, run the GIS 7.5 installation package, selecting the connector type (SOAP Standalone, SOAP Web Module, or GSAP) that matches your 7.2 product. For details, see the *Genesys Integration Server 7.5 Deployment Guide*.

Note: To implement new 7.5 features, you can keep your existing 7.2 Configuration Layer application. Deleting it is optional.

GIS Migration 7.0 or 7.1 to 7.2 (or later)

If you are upgrading from GIS or Genesys .NET Server 7.0 or 7.1, you can install Genesys Integration Server 7.2 for either of two purposes:

- As a maintenance upgrade for GIS or .NET Server 7.0 or 7.1.

In this case, you keep your existing 7.0 or 7.1 Configuration Layer application, and point to it when running the GIS 7.2 installation package. Select the GIS 7.2 installation type that matches your 7.0 or 7.1 product: SOAP Standalone or SOAP Web Module as an upgrade for GIS 7.0/7.1, or GSAP as an upgrade for .NET Server 7.0/7.1.

Under this migration path, GIS 7.2 will provide the same level of functionality as its 7.0/7.1 predecessor. See the *Genesys 7 Interoperability Guide* for information on the compatibility of Genesys products with various Configuration Layer Environments; Interoperability of Reporting Templates and Solutions; and *Gplus* Adapters Interoperability.

- To implement new 7.2⁺ (or later) features.

First, install Configuration Server 7.2⁺, then a GIS 7.2⁺ application template, then a new application based on that template. Finally, run the GIS 7.2⁺ installation package, selecting the connector type (SOAP Standalone, SOAP Web Module, or GSAP) that matches your 7.0 or 7.1 product. For details, see the *Genesys Integration Server 7.2 Deployment Guide* (or later).

GIS Migration 6.5.1 to 7.x

This section presents step-by-step instructions for migrating from GIS 6.5.1 to a 7.x release.

Migration Paths You have two migration paths:

- You can install GIS 7.x over your current 6.5.1 version of GIS, and either use your 6.5.1 application or (to implement newly available features) import the new application template and create a new application.
- You can uninstall your current version of GIS, and perform a fresh installation of GIS 7.x. For instructions, see the *Deployment Guide* for your target version of GIS. You can use your existing 6.5.1 GIS application with GIS 7.x, or (to implement newly available features) import the new application template and create a new application.

Warning! If you are deploying GIS with the WebSphere application server, Genesys recommends that you uninstall GIS 6.5.1 and perform a completely new deployment, including creation of a 7.x application.

Installation Wizard The installation wizard sets the Configuration Server host name, Configuration Server port, and GIS application name. If you experience some problem during the installation, update the startup files for your system type with the correct Configuration Server host name, port number, and GIS application name:

- For Windows systems, the startup file is named `run_gis.bat`, `run_gis_soap.bat`, or `startServer.cmd`.
- For UNIX-based systems, the startup file is named `run_gis.sh`, `run_gis_soap.sh`, or `startServer.sh`.

If you left all application option settings at the default values, and your client application does not require legacy options that no longer exist in the target version, no further configuration is required. Your migration is complete.

You might choose to update your Configuration SDK client application to take advantage of new functionality. See “6.5.1 to 7.x Configuration API” on [page 177](#) for more information.

Start and Test GIS In the *Deployment Guide* for your target version of GIS, see the “Start and Test GIS” chapter for instructions on starting GIS and testing your installation.

GIS Migration 6.1 or 6.5.0 to 7.x

This section presents instructions for migrating from GIS 6.1 or 6.5.0 to a GIS 7.x release. Strictly speaking, there is no migration from 6.1 or 6.5.0 to 7.x. You must entirely remove GIS 6.1 or 6.5.0, and install GIS 7.x using the procedures for a new installation. These procedures are documented in the *Genesys Integration Server 7.2 Deployment Guide* (or, for version 7.0 or 7.1, the *Genesys Developer Program 7.1 Genesys Interface Server Deployment Guide*).

To Remove GIS 6.1 or 6.5

- On Windows platforms, use the Add/Remove Programs utility to uninstall the 6.1/6.5.0 version of GIS.
- On UNIX-based platforms, delete all folders containing the GIS files.

To Install GIS 7.x

- Install and configure the 7.x version of GIS, importing the new template and configuring it as described in the appropriate version of the *Deployment Guide*.

Note: Starting with release 6.5.1, GIS used a new application type in the Configuration Database. Therefore, to use GIS 7.0 or 7.1, you must upgrade your Configuration Database and Configuration Server to version 6.5 or higher.

Start and Test GIS

In the *Deployment Guide* for your target version of GIS, see the “Start and Test GIS” chapter for instructions on starting GIS and testing your installation.

Update Your Client Application

Because the GIS 7.x API is not compatible with the 6.1/6.5.0 API, you must rewrite your client application.

For assistance in understanding the differences between 6.1/6.5.0 and 7.x:

- See “Options Tab Option Changes” on [page 167](#) for removed and added configuration options.
- See “6.1 and 6.5.0 to 7.x Statistics API” on [page 171](#) for changes to the API.

Changes to GIS Application Options

This section documents the differences between the 6.1/6.5.0 and the 6.5.1/7.x application options, and provides instructions for making changes to your GIS application settings.

Options Tab Option Changes

Table 25 on [page 167](#) shows the changes made to the GIS application options from 6.1/6.5.0 to 6.5.1. The section “restriction_time” on [page 167](#) outlines a change made from 6.5.1 to 7.x.

Note: Table 13 only shows changes that affect the Statistics API. A number of options were also added for the new Configuration API.

Table 25: GIS Application Options Changes

GIS 6.1 and 6.5.0 Section	Option	Default Value	GIS 6.5.1 Section	Option	Default Value
License	license-file	name of customer license file	License^a	license-file	name of customer license file
Logs	various options	various values	Logs^b	various options	various values
service_statistic	restriction_time	10	SessionService	sessionTimeout	3600
			StatService	ScopeStatEvents	15

- a. No change from 6.1, 6.5.0, or 6.5.1 to 7.x.
 b. No change from 6.1, 6.5.0, or 6.5.1 to 7.x.

sessionTimeout

If you are already using a custom sessionTimeout option or you want a sessionTimeout value other than the default (3600 seconds), enter the desired value for this option.

ScopeStatEvents

If you are already using a custom ScopeStatEvents option or you want a value for ScopeStatEvents other than the default (the last 15 interactions), enter the desired value for this option.

restriction_time

If you require the restriction_time option: In version 6.5.1, this option was located in the service_statistic section. In versions 7.x, it is located in the StatService section. If necessary, add this option to the new section as follows:

1. On the Application object’s Options tab, right-click in the StatService section, and select New from the shortcut menu that opens.

2. Enter `restriction_time` in the Option Name field.
3. Set the value of this option to your previous `restriction_time` value.
4. Delete your original `restriction_time` entry in the `service_statistic` section.

error_check

If you require the `error_check` option, which does not exist in 6.1, you must add it to the GIS application. To add this option:

1. Right-click in the StatService section of the Application object Options tab and select New from the shortcut menu that opens.
2. Enter `error_check` in the Option Name field.
3. Set the new `error_check` value to the previous-`error_check` value (the default value is true).

Note: If you are migrating from a pre-6.5.000.09 version, you will not have a previous-`error_check` value (the option was introduced in release 6.5.000.09). In this scenario, set `error_check` to true.

Changes to Error Messages 6.5.1 to 7.x

Genesys has changed the text of certain error messages between GIS 6.5.1 and GIS 7.x, with the goal of making these messages more specific and complete. If your client applications take actions that trigger off these exception strings, you will need to change the triggers in your code.

Table 26 presents the text of error messages in GIS 6.5.1 and GIS 7.x. Shaded rows indicate messages whose text has changed between these versions.

Table 26: Error Messages Changed Between GIS 6.5.1 and GIS 7.x

Error Condition	Response in GIS Version 6.5.1.000.14	Response in GIS Version 7.x
Browse services with a bad session ID	Session unknow	Unknown session
Get service with bad service list	Bad Service List: License checkout SessionService:1126616496563H3: :GIS_STASVICE NOK: License server does not support this feature(-18,147)	bad list: Checking out feature GIS_STASVICE in 7260@frbred0059407: License server does not support this feature(-18,147)
Get service with bad SID	Session unknow	Unknown session
Login with bad password	Login <user_login> incorrect	Authenticate : Password is incorrect

Table 26: Error Messages Changed Between GIS 6.5.1 and GIS 7.x (Continued)

Error Condition	Response in GIS Version 6.5.1.000.14	Response in GIS Version 7.x
Login with unknown user	java.lang.Exception: User unknown	Authenticate : User not found
Call to a bad service target	Service not found	Service not found
Logout with bad SID	getAttribute: Session doesn't exist	getAttribute: session doesn't exist
Release services with a bad service list	Bad Service List: License checkout SessionService:1126616499735H9: :GIS_STATSECE NOK: License server does not support this feature(-18,147)	bad list: Checking out feature GIS_STATSECE in 7260@frbred0059407: License server does not support this feature(-18,147)
Release services with a bad session ID	Session unknow	Unknown session
Retrieve profile with a bad profile type	java.lang.IllegalStateException	java.lang.IllegalStateException
Subscribe Statistic with bad notification mode	java.lang.IllegalStateException	java.lang.IllegalStateException
Subscribe Statistic with bad object ID	Agent 'bad_object_id' (Tenant '<TenantName>') not found	java.rmi.RemoteException: Agent 'bad_object_id' (Tenant '<TenantName>') not found
Subscribe Statistic with bad object type	java.lang.IllegalStateException	java.lang.IllegalStateException
Subscribe Statistic with bad resource	Session unknow	Unknown session
Subscribe Statistic with bad SID	Session unknow	Unknown session
Subscribe Statistic with bad statistic name	Supplied Stat Type name not known on server side.	java.rmi.RemoteException: Supplied Stat Type name not known on server side.
Retrieve Subscribed Statistic (timeout test)	timeout	java.rmi.RemoteException: timeout
Retrieve Subscribed Statistic without statistic ID	bad references	java.rmi.RemoteException: bad references
Retrieve Subscribed Statistic with good parameters	Session unknow	Unknown session

Table 26: Error Messages Changed Between GIS 6.5.1 and GIS 7.x (Continued)

Error Condition	Response in GIS Version 6.5.1.000.14	Response in GIS Version 7.x
Retrieve Subscribed Statistic with bad statistic ID	bad references	java.rmi.RemoteException: bad references
Retrieve Subscribed Statistic with good parameters	java.lang.IllegalStateException	java.lang.IllegalStateException
Subscribe Statistic without statistic ID	StatisticId parameter is empty	java.rmi.RemoteException: StatisticId parameter is empty
Subscribe Statistic with bad notification mode	java.lang.IllegalStateException	java.lang.IllegalStateException
Subscribe Statistic with bad resource	subscribe statistic	java.rmi.RemoteException: Stat Server error [no server defined]
Subscribe Statistic with bad SID	Session unknow	Unknown session
Subscribe Statistic with bad statistic name	OpenStat: Supplied Stat Type name not known on server side.	java.rmi.RemoteException: OpenStat: Supplied Stat Type name not known on server side.
Subscribe Statistic with bad tenant	OpenStat: Tenant '<bad_tenant_name>' not found	java.rmi.RemoteException: OpenStat: Tenant '<bad_tenant_name>' not found
Subscribe Statistic with a bad tenant name	OpenStat: Tenant '<bad_tenant>' not found	java.rmi.RemoteException: OpenStat: Tenant '<bad_tenant>' not found
Subscribe Statistic with bad time interval name	java.lang.IllegalStateException	java.lang.IllegalStateException
Subscribe Statistic with inexistant object ID	OpenStat: Agent 'inexistant_object' (Tenant '<TenantName>') not found	java.rmi.RemoteException: OpenStat: Agent 'inexistant_object' (Tenant '<TenantName>') not found
Try to retrieve an unsubscribed statistic	bad references	java.rmi.RemoteException: bad references
Unsubscribe Statistic with bad session ID	Session unknow	Unknown session

Table 26: Error Messages Changed Between GIS 6.5.1 and GIS 7.x (Continued)

Error Condition	Response in GIS Version 6.5.1.000.14	Response in GIS Version 7.x
Unsubscribe Statistic with bad statistic ID	StatId not found	java.rmi.RemoteException: StatId not found
Login with bad tenant	java.lang.Exception: Bad Tenant	[Not applicable: Login succeeds if user belongs to the Configuration Layer.]

Key:	Message change	No message change
-------------	----------------	-------------------

6.1 and 6.5.0 to 7.x Statistics API

Note: The 6.5.1 and 7.x APIs are fully compatible. If your current statistics-gathering application uses the 6.5.1 API, you can disregard this section.

The 6.1/6.5.0 Statistics API, which was retained in the 6.5.1 release, is no longer available in releases 7.x. This section provides a brief overview of the differences between the 6.1/6.5.0 and 7.x Statistics APIs.

Warning! To migrate from release 6.1/6.5.0 to a 7.x release, you must rewrite your statistics-gathering application.

To fully understand the nature of the differences between 6.1/6.5.0 and 7.x:

- Compare the API information in the *6.1 Gplus Foundation Real-Time Statistics API Developer's Guide* with that in the target version's *Statistics SDK Developer's Guide* and *API Reference* (or *Reference Manual*).
- Compare the 6.1 code samples, which are installed from the 6.1 *Gplus Foundation Real-Time Statistics API DVD*, with the code examples for the 7.x release, which are located on the *Documentation Library DVD*.

Note: All documents are available on the Technical Support website and on the *Documentation Library DVD* (for versions through 7.1) or the *Genesys Developer Documentation Library DVD* (for version 7.2). The 7.0 and 7.1 code examples are only on the *Documentation Library DVD*. The 7.2 and 6.1 code samples are located on the software DVD.

Use the *Statistics SDK Developer's Guide*, and the associated code examples, to guide you in your development of your new statistics-gathering application.

- Take Advantage of New Features** Although session and configuration information retrieval have changed, the 7.x Statistics API interface uses the same statistical request operations as the 6.1/6.5.0 API. However, changes to the data types included in these operations make it possible to retrieve much more complex information than previously. Genesys recommends that you carefully review the Statistics SDK documentation when designing your new application to take full advantage of the improvements in the 7.x interface.
- Review the 7.x WSDL Files** To be certain that you take account of all changes from 6.1/6.5.0 to 7.x, base your development on the latest version of the GIS APIs, as documented in the Statistics, Session, and Configuration WSDL (Web Services Description Language) files.

Note: To generate these files, see the instructions in the *Deployment Guide* for your target version of GIS.

Namespaces, bindings, the port type, and the service name have changed, as have the operations (and their associated messages) and the data types. Operation (method) changes and data type changes are described in the sections below.

Changes to Statistics API Methods from 6.1 and 6.5.0 to 7.x

The main statistics-gathering methods, `retrieveStatistic`, `subscribeStatistic`, `retrieveSubscribedStatistic`, `retrieveStatisticalProfile`, and `unsubscribeStatistic`, remain unchanged. However, the two new APIs, Session and Configuration, have taken over certain functionality formerly provided by the 6.1/6.5.0 Statistics API.

Functions Now Performed by the Session API

The Session API handles login, logout, and license verification for all GIS-based SDKs. The following Session API methods are new:

- `login`
- `getService`
- `browseService`
- `releaseService`
- `logout`

They replace these discontinued Statistics API methods:

- `Login`
- `Logout`

- SessionUpdate

For details, see the *Statistics SDK API Reference* (or *Statistics SDK Web Services API Reference*) chapter entitled “Using the Session API.”

Functions Now Performed by the Configuration API

Configuration information, formerly available using the `retrieveConfiguration` method in the 6.1/6.5.0 Statistics API, is now provided by the Configuration API. This API is presented by the SOAP interface of either a release 7.x master Configuration Server, or a release 7.x or 6.5 Configuration Server Proxy (CS Proxy). GIS tunnels configuration request messages to the specified Configuration Server or CS Proxy SOAP interface, which returns information on the requested configuration objects.

Prerequisites for Using the Configuration API

1. To retrieve configuration information, you must be able to send configuration request messages to a Configuration Server, version 7.x, or to a CS Proxy, version 6.5 or higher.
2. You must configure the `soap` section of the `confserv.cfg` file for your Configuration Server/CS Proxy. For details, see the “Configure the Configuration Server SOAP Port” section in the “Configure and Install GIS” chapter of the *Deployment Guide* for your target version of GIS.

Current Configuration API Methods

A subset of Configuration API methods, listed below, are available to users without a Configuration SDK license. They effectively provide read-only configuration information. To use the whole set of Configuration API methods, you must acquire a Configuration SDK license.

If you do not have a Configuration SDK license, use these messages to retrieve configuration information:

- `refresh`
- `get`
- `getex`
- `getVersion`

For details on how to use these methods, see the chapter, “View Configuration Methods,” in your *Statistics SDK Web Services API Reference* or *Statistics SDK Reference Manual*.

Changes to Statistics API Types

Data types specify the precise content and format of the information you must submit to GIS and that you can expect to receive back. Therefore, changes in data types affect the content of your requests to the Statistics API.

Some of these changes are additions and deletions from the list of types. However, in some cases, the data within a type has changed.

Warning! If you plan to reuse any code sections from your previous application, the revised version must reflect changes to the data types.

Full information about new and changed types appears in your *Statistics SDK Web Services API Reference* or *Statistics SDK Reference Manual*.

Simple Types

[Table 27](#) presents all additions, removals, and changes to Statistics API simple types between 6.1 and 7.x.

Table 27: Changes to Simple Types

Name	Change	Description
eventValueTypeType	No change	Not applicable
objectType	No change	Not applicable
requestReference	Removed	Not applicable
rfc2254	Removed	Not applicable
statisticalProfileType	No change	Not applicable
timeIntervalType	No change	Not applicable
notificationMode	Added	Specifies Polling or Blocked mode
scheduleMode	Added	Specifies when a statistic is to be updated
statisticStateType	Added	Indicates the status of a specified object

Complex Types

Table 28 presents all additions, removals, and changes to Statistics API complex types between 6.1 and 7.x.

Table 28: Changes to Complex Types

Name	Change	Description
actions	No change	Not applicable
arrayOf_subscription	Added	An array of elements of the statisticSubscription type
configurationRequest	Removed	Not applicable
eventValue	Changed	<ul style="list-style-type: none"> The unknownValue element has been removed. The sValue element has been added. The stateValue element has been added. This element is not currently used. Its value is always null.
eventValues	Added	An array of eventValue values
identity	Removed	Not applicable
loginResponse	Removed	Not applicable
metric	No change	Not applicable
notification	Changed	<ul style="list-style-type: none"> The mode element now contains a notificationMode value. The timeout element has been added.
objectIdType	No change	Not applicable
objectTypes	Added	An array of objectType values
parameter	No change	Not applicable
parameters	No change	Not applicable
profileInfo	No change	Not applicable

Table 28: Changes to Complex Types (Continued)

Name	Change	Description
retrieveConfigurationResponse	Removed	Not applicable
retrieveStatisticalProfileResponse	Changed	The reference element has been removed.
retrieveStatisticResponse	Changed	The reference element has been removed.
retrieveSubscribedStatisticResponse	Changed	The reference element has been removed.
schedule	Changed	<ul style="list-style-type: none"> The notificationMode element now consists of a scheduleMode value rather than a string value. The timeout element has been added. The insensitivity element has been added.
statistic	No change	Not applicable
statisticInfos	Changed	This is now an array of statisticTypeInfoType values.
statisticState	Added	Not currently used
statisticStateData	Added	Not currently used
statisticStates	added	Not currently used
statisticSubscription	No change	Not applicable
statisticSubscriptions	Changed	This now takes an ArrayOf_subscription value.
statisticType	No change	Not applicable
statisticTypeInfoType	Changed	The objectType element has been replaced by the objectTypes element.
statisticValue	Changed	The eventValue element has been replaced by the eventValues element.

Table 28: Changes to Complex Types (Continued)

Name	Change	Description
statisticValues	No change	Not applicable
timeInterval	No change	Not applicable
timeProfile	No change	Not applicable
timeProfiles	No change	Not applicable
timeRangeType	No change	Not applicable
unsolicitedNotification	Added	Specifies the URL to which GIS sends automatic notification of statistics updates

6.5.1 to 7.x Configuration API

This section summarizes the key changes in the Configuration API from 6.5.1 to 7.x.

To fully understand the nature of the differences, compare the API information in the *6.5 Genesys Configuration SDK Developer's Guide and Reference Manual* with that in the target version's *Configuration SDK Developer's Guide and API Reference (or Reference Manual)*.

Note: All these documents are available on the Technical Support website and on the Documentation Library DVD or Developer Documentation Library DVD.

New Configuration Server SOAP Interface

If you are using Configuration Server 7.x, you can request configuration information from a Configuration Server that has been set up as either a master or a proxy. In 6.5, the necessary SOAP interface was available only through CS Proxy.

For instructions on setting up the SOAP port for either Configuration Server or CS Proxy, see the *Deployment Guide* for your target version of GIS

For more information on Configuration Server and CS Proxy, see the *Framework 7.x Deployment Guide*.

Unregister Operation

While most of the operations and data types remain the same, release 7.x includes the new `unregister` operation, which performs the following actions:

- Logs your client out of Configuration Server.
- Cancels all active subscriptions for notifications.
- Closes the HTTP session.

You should use this operation to complete each session.

Unsolicited Notification

The 7.x Configuration API includes the new unsolicited notification functionality, which enables you to have Configuration Server (not necessarily GIS—there may be a direct link for unsolicited notifications) send updates on configuration objects to which you have subscribed without your application having to explicitly request them each time.

For information on implementing this feature, see the *Configuration SDK Developer's Guide* and its associated code examples, which are available on the Documentation Library DVD or on the Developer Documentation Library DVD.



Part

3

Reporting Migration

This section provides general instructions for migrating the following standard pre-7.2 environments to releases 7.2.x and 7.5.x:

- Contact Center Analyzer (CC Analyzer)
- Call Center Pulse (CC Pulse)
- CCPulse+

Note: Genesys Reporting 7.5.x comprises CCPulse+ 7.5.x and CC Analyzer 7.2.x.

This section also introduces the 6.5 Reporting Service Pack, a utility for migrating reporting templates from pre-6.5 versions to release 6.5. Additionally, it discusses important issues to consider before converting your data.

The information is divided into the following chapters:

- Chapter 13, “Introduction to Reporting Migration,” on page 181 discusses preliminary migration procedures and issues to consider when planning a Reporting migration.
- Chapter 14, “Changes in Reporting 7.x,” on page 193 provides information for upgrading Reporting components and configuration options from releases 6.x to 7.5.x. This section discusses changes (additions, deletions, and modifications) you must make during migration.
- Chapter 15, “Reporting Migration Procedures,” on page 211 discusses migrating pre-7.2 releases of CC Analyzer and CC Pulse/CCPulse+ to releases 7.2.x and 7.5.x.
- Chapter 16, “Reporting Service Pack 6.5,” on page 217 provides information for administrators who deploy this migration utility and use it to migrate reporting templates to release 6.5.

For additional configuration and installation information, refer to the *Reporting 7.5 Deployment Guide*. The *Genesys Migration Guide* does not duplicate that information.

Genesys encourages you to contact Genesys Technical Support for assistance with the following:

Migration in nonstandard environments, for example:

- Using CC Analyzer in an unconventional way
- Using the product on unsupported platforms
- Altering the structure of your Operational Data Storage (ODS) and/or Data Mart
- Customizing the Genesys-provided templates

You should also contact Genesys Technical Support if you encounter any problems with the standard migration summarized previously.



Chapter

13

Introduction to Reporting Migration

This chapter discusses the preliminary migration procedures and includes some important considerations when planning a Reporting migration, including:

- Implementation considerations.
- Architectural differences.
- Configuration and installation issues.
- Framework issues.
- Template and report issues.

This chapter has the following sections:

- [Preliminary Migration Procedures, page 181](#)
- [Migration Considerations, page 182](#)
- [Interoperability Among Framework and Reporting Components, page 192](#)

Preliminary Migration Procedures

Note: If you want to upgrade your operating system, you must do this before migrating your Genesys product.

The migration process for Reporting 7.5.x includes the following preliminary procedures:

1. Review Chapter 1, “Migration Roadmap,” of this guide.
2. See [Chapter 15](#) of this guide for a description of the upgrade order.
3. Review the licensing requirements for Framework 7.x. See Chapter 2, “Licensing Migration,” of this guide.

4. Review the section “Migration Considerations” on [page 182](#) of this chapter for Reporting 7.x.
5. Examine the section “Changes in Reporting 7.x” in [Chapter 14](#).
6. Study the section “Changes to Configuration Options and Runtime Parameters” in [Chapter 14](#).
7. See also the *Genesys 8 Interoperability Guide* for information on the compatibility of Genesys products with various Configuration Layer Environments; Interoperability of Reporting Templates and Solutions; and *Gplus* Adapters Interoperability.

Reference Materials

You may find these other manuals useful during migration:

- *Genesys Licensing Guide* for information about changes in licensing.
- *Reporting 7.5 Deployment Guide* for wizard-driven configuration and installation procedure.
- *Reporting Technical Reference Guide for the Genesys 7.2 Release*, for descriptions of report templates.
- *Reporting 7.5 Reference Manual*, for information about Reporting performance.
- *Reporting 7.5 CCPulse+ Administrator's Guide*, for information about CCPulse+ configuration options.
- *Reporting 7.2 Data Sourcer User's Guide*, for information about Data Sourcer configuration options.
- *Reporting 7.2 ETL Runtime User's Guide*, for information about ETL Runtime configuration options.
- *Genesys 8 Interoperability Guide* for information on the compatibility of Genesys products with various Configuration Layer Environments; Interoperability of Reporting Templates and Solutions; and *Gplus* Adapters Interoperability.

Migration Considerations

Before migrating your environment, consider:

- Architectural and feature differences between the releases.
- Supported versions of relational database management systems (RDBMSs) on which you can run the provided upgrade scripts.
- Changes made to both your data and database structure as a result of running the upgrade scripts.
- Impact on your customized reports following a successful migration.

These and other issues are discussed in a general fashion in this section. To perform the actual migration, refer to Chapter 15, “Reporting Migration Procedures,” on [page 211](#)

Contact Genesys Technical Support for migration issues not addressed in this chapter and for *nonstandard environments*.

Once you have successfully migrated your Reporting environment, Genesys strongly recommends that you cease using prior versions of the Reporting software (though you may continue using the same version of BrioQuery Designer if you prefer). Refer to the current Reporting documentation set for information on how to operate CC Analyzer and CCPulse+.

Implementation Considerations

Develop an implementation strategy for migrating your Reporting environment along with Genesys Framework and other Genesys solution migrations. This approach is especially important if the Reporting environment is distributed over several Data Marts or if more than one person is to perform the migrations. In defining an implementation strategy, ask these sorts of questions:

- When will your Genesys Framework environment be migrated?
- Must you migrate your Framework environment for CCPulse+?
- Will you conduct a phased rollout of Reporting, or will you roll it out all at the same time?
- Do you intend to stage the migration or conduct a pilot? How will you verify its results—its reports?
- Did you customize the solution-provided reports?
- What is your current system’s configuration and does Genesys now support it? Have you upgraded elements of your network since your first purchase? What version is your current operating system? What version is your current relational database management system (RDBMS)?
- Have you identified all ODSs and Data Marts in your Reporting environment that you intend to convert?
- Do you have the resources to back up all required data?
- Do you have any customized scripts or processes, outside Genesys Reporting, that depend on the names of your layout templates?
- When will you migrate your other Genesys solution environments?
- How will you transfer knowledge to other implementation teams?

Here are some guidelines to help you answer these questions:

- In general, Genesys recommends that you migrate Reporting *following* your Genesys Framework migration. In a Reporting environment with several Data Marts, the minimum set of components for rolling out Reporting in stages constitutes one Data Mart and *all* of its constituent

ODSs. *Do not start* either ETL Runtime's Transformation or Aggregation modules until you have completely and successfully converted all data for all ODSs writing to ETL Runtime's Data Mart.

- To verify your reports, transfer all pending data from the Data Sourcer emergency save file and ODSs to the Data Mart before migrating your Reporting environment. This step includes:
 - Extracting data from the emergency save file to a SQL file.
 - Executing the SQL file to transfer the saved data to ODS.
 - Transforming and aggregating all ODS data using ETL Runtime.
 - Recreating tenant accounts (for multi-tenant environments).

Run and store the results of a set of reports using various aggregation levels, and then migrate your environment and rerun the same set of reports, but using the new 6.x (or 7.x) templates (*.bqy files). Your results should match.

Note: Unless you transfer and aggregate all pending data, 6.x and 7.x reports may report different statistical values than the reports run in a previous release. The difference is visible with the most recent aggregation levels: for example, for the very last hour for the Daily report.

Architectural Differences

This section discusses the architectural differences between 6.x and 7.x releases for CC Analyzer and CC Pulse/CCPulse+.

Note: In this section, architectural differences refer to differences in the structure and organization of Genesys software.

CC Analyzer

- CC Analyzer 7.2.1** There are no architectural differences between CC Analyzer 7.2.1 and previous releases of CC Analyzer.
The Hyperion Performance Suite 8.5.0.3. is packaged with CC Analyzer 7.2.1.
- CC Analyzer 7.2** High Availability of historical reporting data has been implemented in CC Analyzer and CCPulse+ by using a pair of Data Sourcers that operate in hot standby mode and a pair of Stat Servers that operate in special warm standby mode.
The Hyperion Performance Suite 8.5.0.2. is packaged with CC Analyzer 7.2.
- CC Analyzer 7.1** There are no architectural differences between CC Analyzer 7.1 and previous releases of CC Analyzer.
- CC Analyzer 7.0** CC Analyzer introduced no architectural changes. However, the Hyperion Performance Suite 8.3, instead of Brio 6.6, comes packaged with the 7.0.2

release. Brio Technology was acquired by Hyperion Solutions Corporation, and the Hyperion Performance Suite is Hyperion's improved version of Brio. No changes were necessary to Report Generation Assistant, which is powered by this third-party software.

CC Analyzer 6.5 CC Analyzer Data Sourcer and CC Analyzer Data Mart components service both CC Analyzer and CCPulse+; component names are again named Data Sourcer and Data Mart, without any prefix.

To clarify which Data Sourcer component is being discussed in the 6.5 documentation set, references to “the Stat Server–based Data Sourcer” or “IS Data Sourcer” are used. All other components that belong to the Data Collection Services or Data Mart Services also serve CCPulse+ and have been appropriately renamed.

CC Analyzer 6.1 New functionality was added to CC Analyzer that:

- Required more of a change in the metadata that is stored in the ODS and Data Mart databases than a change in table structure (although table structures did change, too).

See the *Reporting 6.1 Data Mart Conceptual Data Model* for a complete description of Data Mart schema.

- Introduced the CCA Starter application and ETL-Proxy Application object to the Configuration Server to control the execution of the various ETL Runtime modules.

See the *Reporting 6.1 ETL Runtime User's Guide* and the *Reporting 6.1 Starting and Stopping Procedures* document for more information about CCA Starter.

This information can also be found in the *Reporting 7.2 ETL Runtime User's Guide* and *Reporting 7.5 Deployment Guide*.

Installing New Applications Given Existing Objects

Note: Genesys Framework also underwent architectural changes from its previous release—most significantly, the introduction of the Management Layer and Solution Control Interface (SCI) that allow you to control, monitor, start, and stop Genesys solutions and their components from one location. See Part 2 of this guide for a discussion of Framework changes between the releases and for migration procedures.

CC Pulse/CCPulse+

Note: Genesys recommends that you use the latest generally available release of CCPulse+, and that you do *not* use different releases of CCPulse+ simultaneously.

CCPulse+ 7.5.1 In release 7.5.1, the Extended Current Status pane in the CCPulse+ workspace has been enhanced to display an additional window—the Capacity

window—provided that new capacity configuration options are set in the CCPulse+ application.

CCPulse+ 7.5 There are no architectural differences between CCPulse+ 7.5 and previous releases of CCPulse+.

CCPulse+ 7.2 CCPulse+ 7.2 added the capability to query the Genesys Info Mart database to produce query-based reports. The functionality requires Genesys Info Mart release 7.2.

CCPulse+ performance also was improved. A larger number of objects can now be monitored and sorted in a single view.

CCPulse+ 7.1 There are no architectural differences between CCPulse+ 7.1 and previous releases of CCPulse+.

CCPulse+ 7.0 In release 7.0, changes were introduced to support more sophisticated printing capabilities, advanced view and workspace management, and custom formula statistics.

CCPulse+ 6.5 Release 6.5 presented a significant architectural change: The application connects to Stat Server, as before, for real-time data, but connects to a Data Mart for historical data. Because of this significant change in functionality the name was changed from CC Pulse to CCPulse+, which suggests its former purpose plus its new historical twist. All solution-provided CCPulse+ templates (with the exception of DNView) were modified to associate a historical column in the Data Mart with its real-time equivalent.

See “CCPulse+ Metrics” section of “Understanding the Out-of-Box Templates” chapter in the *Reporting Technical Reference Guide for the Genesys 7.2 Release* to see how CCPulse+ matches real-time and historical metrics.

CC Pulse 5.1 to 6.1 From an architectural point of view, there were no significant changes in CC Pulse between the first release in Reporting 5.1 to the 6.1 release.

Configuration and Installation Issues

Configuration Wizards Starting with release 7.0, the method for invoking the Reporting configuration wizards has changed. Whereas CC Analyzer and CC Pulse 6.1/CCPulse+ 6.5 were deployed through Solution Wizards, starting with the 7.0 release, both are deployed through the stand-alone Solution Reporting Wizard, which you invoke directly from the Framework Wizard Manager. Solution wizards 7.x do not invoke the Reporting wizards.

Installing New Applications Given Existing Objects With preexisting application components already defined in your Configuration Server, you need not configure new Data Sourcer or Data Mart Application objects and before installing them, as recommended in the *Reporting 7.5 Deployment Guide*. (The exception is if you specifically want to

add new application components to your environment.) Instead, after migration, you can proceed directly to installation:

- When installing Data Sourcer 7.0.1, select your original Data Sourcer application name at the `Choose Application` dialog box.
- When installing Data Sourcer 7.0.2 and higher releases, select your original Data Sourcer application name at the `Select Application` dialog box.
- When installing ETL Runtime 7.0.1, select your original Data Mart application at the `Selecting New Application in ConfigServer` dialog box.
- When installing ETL Runtime 7.0.2 and higher releases, select your original Data Mart application name at the `Select Application` dialog box.

Use version 1.4 (or higher) of the Java Runtime Environment (JRE). Note that the JRE installed must comply with US Energy Policy Act of 2005.

Installing Stand-Alone Components

If you only need to install new components to your Reporting environment, as is the case for deploying hot fix releases, you may do so without using the Reporting wizards. Refer to the deployment procedures associated with your hot fix release.

Heterogeneous Environments

- Use 6.5 Genesys Wizard Manager if you are configuring Reporting 7.x for Genesys 6.5 solutions. (This is the only way to configure Reporting 7.x by using wizards for ICS 6.5.)
- Do not use 6.5 wizards if you are configuring Reporting 7.x applications with the deployed solution-specific templates from the Reporting Templates 7.x DVD.
- Use 6.5 Solution wizards if you are configuring Reporting 7.x applications using solution-specific 6.5 data from the solution-specific 6.5 DVD.

Assigning Reporting to Solutions

In the 7.x releases, Reporting components are not assigned to solutions as they were in previous releases. If you need to assign Reporting components to particular solutions—to use SCI, for example—manually make the assignment using Configuration Manager.

Uninstalling CCPulse and DMA

- For CCPulse+ 7.x, remember to uninstall earlier versions of CC Pulse/CCPulse+ before installing 7.x.
- You can only have one DMA 7.0.2 or higher release installed on your machine. This restriction was not imposed on previous versions of DMA.

Different Microsoft SQL JDBC Driver

The JDBC driver provided with the 7.0.2 and higher releases of Historical Reporting differs from that provided in previous releases. As a result, to use this new driver, you must update your actively used properties files to use its syntax.

For instance, in `etl.properties` change:

```
mssql : 'jdbc:weblogic:mssqlserver4:<dbname>@<host>:port'
```

to

```
mssql : 'jdbc:jtds:sqlserver4://dbhost:dbport:DatabaseName=dbname'
```

Also, in Configuration Manager, open the Database Access Point Application object corresponding to your Data Mart and update the `jdbcurl` option in the `jdbc` section to use this language.

In the 7.0.2⁺ release, ETL Runtime, ETL Assistant, Data Sourcer, and the Reporting configuration wizards all use the jTDS driver.

Template Issues

Layout Template Names

Starting with Reporting 6.1, the names of layout templates and report templates are limited to 10 alphanumeric characters. Before 6.1, these names could hold up to 24 characters and contain special characters, including spaces, periods, and commas. With the added feature of using the same reports across several tenants in a 6.1, 6.5, or 7.x environment, template names must now accommodate a tenant-alias prefix.

Note: See “Tenant Alias Update Module” in the *Reporting 7.2 ETL Runtime User’s Guide* for more information about sharing reports across tenants.

In converting pre-6.1 data to 7.x:

- All layout templates are renamed to a predefined name of 10 characters or fewer.
- All custom layout templates are renamed during data conversion to a prefix and a number; report layout names remain the same. (See “Report Issues” on [page 191](#) for more information.)
- Customized Hyperion Query Designer (formerly BrioQuery Designer) reports may need further editing to accommodate/reflect new naming.

Another template issue involves the location of report templates (.bqy files), which changed from the Reporting CD (prior to 6.1), then to the Solution CD (for 6.1 and 6.5), and finally to the Reporting Templates DVD (7.x). The Reporting Templates DVD was newly introduced in the 7.0 release.

Report Layouts Based on the Same Layout Template

ETL Runtime versions 6.5 and 7.x automatically create unions of report layouts based on the same layout template. In some atypical cases, this could result in the following:

- If there is a deleted report layout, the object set could be inconsistent because object sets are not tracked for deleted report layouts.
- If time profiles or filters in such report layouts are different, the data values in the view could be incorrect.

It is required that report layouts, based on the same layout templates, have the same statistics, filters, and time profiles. Contact Genesys Technical Support for assistance in assigning different report layouts to different layout templates. If you have deleted a report layout, then you need to run the purge module to delete old data and then permanently delete the corresponding report folder, using ETL Assistant, before the upgrade. Contact Genesys Technical Support, if necessary.

Migrating Layout Templates

Minor differences exist between layout templates in different Genesys releases. To take advantage of improved definitions:

1. Learn what the differences are from the “Understanding the Out-of-Box Templates” chapter of the *Reporting Technical Reference Guide for the Genesys 7.2 Release* document.
2. Using DMA, alter the definition of your existing stat types, time ranges, and/or filters to match the improved definitions, as appropriate.

Note: Before modifying statistical parameters, be sure to fully comprehend the impact of modifications as they may affect reports spanning several smaller aggregations periods—such as the monthly and yearly reports. Results may be difficult to interpret as they would combine data before and after the modification.

Starting with the 7.0.2 release, the Reporting Wizards perform an automatic upgrade of layout templates.

Adding New Templates to ODS

You can use the Solution Reporting Wizard to deploy reporting templates to your environment. This Wizard, however, does not add new templates to ODS. To accomplish this, follow the procedure outlined in the “Importing Templates” topic of the *Reporting 7.2 Data Modeling Assistant Help* file.

Upgrading CC Pulse Templates

If you want to use the historical reporting functionality in CCPulse+, Genesys recommends that you upgrade your existing CCPulse templates to release 6.5.001.04 or higher. This version of the templates associates real-time metrics with the corresponding column name in the Data Mart where historical data is found. If you do not use this release (or higher), you must manually associate the two yourself. You can find a listing of the associations made in the “CCPulse+ Metrics” section of the “Understanding the Out-of-Box Templates” chapter in the *Reporting Technical Reference Guide for the Genesys 7.2 Release*.

If you have custom CC Pulse/CCPulse+ templates, thresholds, or actions, save a copy of your stg files (by default, named `templates.stg`, `workspaces.stg`, `thresholds.stg`, and `actions.stg`). Four configuration options in the `Storages` section of the CC Pulse Application object define the location of these files. Using the CCPulse+ import utility, you can import your customizations following upgrade. Refer to “Using the Import/Export Utility” in *Reporting 7.5 CCPulse+ Help* for more information. Also, consider saving

your statistics' profiles by exporting them into a Stat Server configuration file (.cfg).

BQY Consolidation

All Brio/Hyperion report templates have been consolidated and renamed starting with the 7.0.1 release. As a result, the same report functionality is delivered using fewer .BQY files.

6.5 Reporting Templates

The latest available version of ICS reporting templates is 6.5 and they are not included on the Reporting Templates 7.x DVD. The 6.5 templates are only available from the Internet Contact 6.5 DVD, which is the only place from which they can be installed. The Solution Reporting 7.x Wizard does not deploy 6.5 reporting templates.

In addition, the *Reporting Technical Reference Guide for the Genesys 7.x Release* document excludes information about ICS 6.5 templates. To understand these templates, refer to the *Reporting Technical Reference Guide for the Genesys 6.5 Release* document.

Different Definitions for VCB Metrics

Reporting templates for the Voice Callback option of Enterprise Routing were first made available during the 7.0.1 release. All of the metrics from these templates were derived from calculations made directly within Stat Server. The 7.1 release of these templates introduces the VCB Stat Server Java Extension (SSJE), which enables the reports to gather information about callback requests submitted from a Web interface in addition to those submitted from a telephone. You must install the Universal Callback Server 7.1 (or higher) and Stat Server 7.1 (or higher) in your environment to use these templates.

To incorporate this functionality, the VCB SSJE calculates the following seven metrics differently from how they were calculated in 7.0.1:

- CB Request Attempts
- ASAP CB Requested
- Scheduled CB Requested
- Last Hour (CB Requested)
- Successful CB
- Made
- Succeeded

These metrics appear in both the Callback Operation and Callback Queue CCPulse+ reports.

MCR Voice Reporting Templates 7.2

CCPulse+ MCR Voice templates were extended in release 7.2 with new metrics providing both real-time and historical reports for key performance indicators (KPI). To take advantage of improved templates:

1. Learn what the differences are from the “Understanding the Out-of-Box Templates” chapter of the *Reporting Technical Reference Guide for the Genesys 7.2 Release* document.
2. Use Reporting Wizard 7.2 to upgrade your previous set of MCR Voice templates.

3. Deploy ETL Runtime release 7.2 to use the updated templates.

Open Media Sample Templates

A new set of templates, Open Media Sample Templates, was added in release 7.2. These templates are a mere sample of reports that can be created for a custom (open) media. These sample templates are created for a sample media type called media *X* and require appropriate modifications in order to produce reports for a particular custom media type. For instructions, refer to the chapters on “Understanding the Out-of-Box Templates” and “Open Media Statistics” in the *Reporting Technical Reference Guide for the Genesys 7.2 Release* document.

GIM Inbound Voice Reporting Templates

A new set of templates, GIM Inbound Voice Reporting Templates, can be used to create query-based views in CCPulse+. These reports are built from the Genesys Info Mart database and require:

- Genesys Info Mart release 7.2 or higher.
- CCPulse+ release 7.2 or higher.
- Special integration between GIM and CCPulse+.

For descriptions of these templates, refer to the “Understanding the Out-of-Box Templates” chapter of the *Reporting Technical Reference Guide for the Genesys 7.2 Release* document. For templates deployment instructions, refer to the *Reporting 7.5 Deployment Guide*.

Report Issues

All of your pre-6.1 customized report templates (as well as the provided canned templates) are automatically renamed during conversion to 6.1—whether or not they meet the 10-character limitation rule. This new name consists of a prefix and a number, for example, `t_26`. Your customized reports, however, remain untouched by any of the migration steps. This means that you can run them using the same tools you used to create them. If you used CC Analyzer Report Generation Assistant, release 6.0, with BrioQuery Designer, version 6.2.2, for example, you can continue using this tool to run your existing, customized reports following migration. However, to create new customized reports using Genesys tools, you must use the 7.x toolset, which includes Hyperion Query Designer.

The passwords for newly created tenant accounts may also differ from what they were previously. Refer to ETL documentation for password values. You must either issue this password when running your reports or change the password using your normal database tools.

Framework Issues

In release 7.x, the Solution Control Interface (SCI) controls the activation, deactivation, and monitoring of solutions and their components. This was not the case prior to release 6.0.

For details about SCI operation, refer to these sources:

- *Framework 7.x Solution Control Interface Help*
- *Framework 7.x Management Layer User's Guide*

Interoperability Among Framework and Reporting Components

CC Analyzer 7.2.1 requires release 7.2 or higher of DB Server and Configuration Server. You must migrate any pre-6.1 Framework components, convert its data, and make sure that your 7.x Framework runs properly before migrating your Reporting environment. See Part 2, “Framework Migration,” of this guide for migration instructions for Framework.

On the other hand, you can operate any version of CC Pulse or CCPulse+ in any Genesys Framework environment. To take full advantage of a given release’s functionality, however, you must use the matching Framework version—and specifically, the matching Stat Server. The matching Stat Server for CCPulse+ 7.2, for instance, is 7.2.

To further illustrate, the CCPulse+ 7.x application can summarize results gathered by a 6.0 Stat Server. But you will not be able to use the provided 7.x CCPulse+ templates in this scenario because the supporting statistical types and categories on which they are based are not present in a 6.0 Stat Server.

The *Genesys 8 Interoperability Guide* summarizes the compatibility of various releases of Reporting applications to Framework and shows the compatibility between solution Reporting templates and different versions of Stat Server.

For CC Analyzer to function properly and to preserve the data collected thus far, you must:

- Convert the data for all ODSs associated with a particular Data Mart.
- Convert the data for that Data Mart.
- Install all CC Analyzer 7.x components.

CC Analyzer components might function improperly in a heterogeneous environment. For example, ETL Runtime 6.0 does not know about 6.1 Enterprise Routing templates. This means the 6.1 canned reports will not generate any data because the specific views on which they are based do not yet exist in the Data Mart. ETL Runtime 6.0 determines whether a template is customized or canned based on its name. For example, *Agent Template* is a canned template and *AGENT* (the 6.1-equivalent name of the canned template) is customized.

To use the historical reporting functionality in CCPulse+, you must upgrade your CC Pulse application to 6.5 or higher.



Chapter

14

Changes in Reporting 7.x

This chapter provides information for upgrading Reporting components and configuration options from release 6.x to 7.x. This section only discusses changes (additions, deletions, and modifications) in the applications that you must make during migration. The product documentation for each release contains a comprehensive list of changes from release to release.

This chapter has the following sections:

- [Changes in Release Content, page 193](#)
- [Changes to Configuration Options and Runtime Parameters, page 199](#)

Changes in Release Content

Each release of Reporting introduced new features and functionality on one or more of the UNIX and Windows platforms. This section summarizes these new features and functionality. You can find the complete list of supported platforms and operating systems in the *Genesys Supported Operating Systems & Databases* document on the Genesys Technical Support website. The next section, “Changes to Configuration Options and Runtime Parameters” on [page 199](#), lists changes to configuration options between the releases.

Note: Genesys Reporting 7.5.x comprises CCPulse+ 7.5.x and CC Analyzer 7.2.x.

Summary of CC Analyzer Functionality

CC Analyzer 7.2.1 The 7.2.1 release of CC Analyzer adds support for:

- DB2 9.1 RDBMS with DB Server release 7.6.
- The following platforms (applies to Data Sourcer 7.2.1 only):
 - AIX 5.1, 5.2, and 5.3 (32-bit and 64-bit).

- HP-UX 11v.2 (32-bit and 64-bit).

Support for the AIX 4.3.x platform is discontinued for the 7.2.1 release of CC Analyzer.

CC Analyzer 7.2 CC Analyzer 7.2 introduced the following new features:

- Historical Layout Templates and Report Layouts now can be extended with new metrics, even after they have already been used by ETL.
- High Availability of historical reporting data has been implemented by using a redundant pair of Data Sourcers that operate in hot standby mode and a redundant pair of Stat Servers that operate in special warm standby mode.

Notes: Genesys recommends that you use Data Sourcer release 7.1, unless High Availability of historical reporting data is a mandatory requirement for your environment.

The latest generally available release of Stat Server 7.2 (or higher) is required for Data Sourcer 7.2 to operate correctly.

- Support for the following platforms:
 - HP-UX 11.11 (32-bit and 64-bit)
 - AIX 5.3
 - Red Hat Enterprise Linux 4.0
 - Solaris 10 (64-bit)
 - Tru64/Alpha 5.1B (64-bit)
 - Windows Server 2003 (64-bit)
- Support for the Windows NT operating system has been discontinued for all components.
- Support for the following RDBMSs:
 - IBM DB2 8.2
 - Oracle 10g
 - Microsoft SQL Server 2000, SP3 or higher; and 2005, SP1
- Support for the following platforms and RDBMS has discontinued:
 - IBM AIX 4.3
 - Solaris 2.6
 - IBM DB2 7.2

CC Analyzer 7.1 CC Analyzer 7.1 introduced no new features.

CC Analyzer 7.0.2 CC Analyzer 7.0.2 introduced the following features:

- A tenfold reduction in ETL Runtime memory requirements and multi-fold improvement in performance.
- Improved ETL Runtime logging.

- The optional use of seven-day weeks, instead of partial weeks for the first and last weeks of a year, for week-level aggregation.
- Configuration wizards perform database upgrade and report templates upgrade at your option.
- Data Sourcer and ETL Runtime now connect to a Microsoft SQL ODS by using the jTDS JDBC driver.

CC Analyzer 7.0.1 CC Analyzer 7.0.1 corrected some known problems and introduced no new features. In this release, support for Sybase 12.0 was discontinued. Supported RDBMSs include the following:

- Sybase 12.5
- DB2 7.2 SP6+ and 8.1
- Oracle 8.1.7, 9.0i, and 9.2

Note: Oracle 8.1.7 is available with DB Server release 7.5 only.

- Microsoft SQL 2000 SP3

CC Analyzer 6.5 CC Analyzer 6.5 corrected some known problems. In this release, support for the following platforms was discontinued:

- Sybase 11.9
- Oracle 8.06
- Solaris 2.6

CC Analyzer 6.1, Tiers II & III The second and third releases of CC Analyzer 6.1 added support for the following:

- HP-UX, AIX, OSF, and Windows XP operating systems (DMA and ETL Assistant supported only on Windows XP)
- DB2 7.0 RDBMS, SP 6

Oracle binding also was introduced to generate a nearly fivefold improvement in performance.

CC Analyzer 6.1, Tier I The first release of CC Analyzer 6.1 introduced the following new features:

- Improved Data Mart administration and multi-tenancy support
- Report-broadcasting capabilities
- Improved canned layout and report templates for the Enterprise Routing, Network Routing, Outbound Contact, and Internet Contact solutions
- Data Mart Purge Utility
- Support for the following platforms:
 - Windows NT SP6
 - Windows 2000
 - Solaris 2.6, 2.7, 2.8 (32-bit)
 - Solaris 2.7, 2.8 (64-bit)

- Support for the following RDBMSs:
 - Oracle 8.0.6
 - Oracle 8.1.7
 - Microsoft SQL 7
 - Microsoft SQL 2000

CC Analyzer 6.0, Tier II The second release of CC Analyzer 6.0 added support for the Sybase 11.9 and 12.0 RDBMSs on the same platforms.

CC Analyzer 6.0, Tier I The first release of CC Analyzer 6.0 introduced the following new features:

- Integration with the Framework Management Layer.
- Configuration wizards.
- Importing/exporting layout templates by using DMA.
- Layout templates in extensible markup language (XML) format for easy portability.
- Canned or out-of-box layout and report templates for Enterprise Routing, Network Routing, Outbound Contact, and Internet Contact solutions.
- Localization support.
- Support for the following platforms:
 - IBM AIX 4.3 (32-bit and 64-bit)
 - HP-UX 11 (32-bit and 64-bit)
 - Windows NT SP6
 - Windows 2000
 - Sun Solaris 2.6, 2.7 (32-bit)
 - Sun Solaris 2.7 (64-bit)
 - Dec Tru64
- Support for the following RDBMSs:
 - Oracle 8.0.6
 - Microsoft SQL 7
- Support for Solaris 2.5 was discontinued.

Summary of CC Pulse/CCPulse+ Functionality

CCPulse+ 7.5.1 CCPulse+ 7.5.1 introduces the following new features:

- Support for a new `Capacities` property inside the `state` object
- Four new configuration options that enable and display agent and agent group capacity in the CCPulse+ workspace
- Availability of capacity information in threshold and formula scripts
- Simulation within CCPulse+ of capacity information for agent groups
- Enhanced `Extended Current Status` pane that shows capacity per media for agents and agent groups in a new `Capacity` window

- Enhanced visualization of agent and agent group status in the workspace view
- New formatting options that allow CCPulse+ users to choose how to display capacity information in the CCPulse+ workspace
- Enhanced Table and Graph views to display current capacity per media
- Enhanced template wizard to allow the addition of capacity statistics
- Capability to save in HTML format, real-time virtual or agent group (V/AG) membership

Note: The Capacity functionality requires Stat Server release 7.5 (or higher).

CCPulse+ 7.5 CCPulse+ 7.5 introduced the following features:

- The capability to obtain Virtual Agent Group membership directly from Stat Server.
- Support for multiple predefined formats in templates' statistics.
- The capability to create the following new views: Dynamic Real-Time Virtual or Agent Group (V/AG) Membership views that reflect the actual working agents; Single-Object views that are based on any currently active real-time View.
- Improvements to the default display when you create a view including new options: Always on Top and Full Screen.
- A new object, state, that provides extended information about agent status.
- Support for Internet Explorer (IE) 6 has been added. Support for IE 5.5 has been discontinued.
- Support for Windows XP SP2 or higher has been added.

CCPulse+ 7.2 CCPulse+ 7.2 introduced the following features:

- Queue and Routing Point views can now be created based on a group membership. As a result, these views can be extended with Route Points and Queues that are newly added to the configuration.
- Place Groups and DN Groups can now be created based also on a group membership.
- You can configure CCPulse+ to accept or ignore notifications from Configuration Server about newly created configuration objects that are reportable objects in the Call Center Objects pane.
- Support for low-level (less than one hour) aggregation has been added. This appears as a No Aggregation option when you are creating historical views.

Note: For a particular object, a level of No Aggregation generates approximately 24 records per day.

- Improvements have been made to the threshold engine. For example, it now propagates thresholds to new objects that are added to an existing view.
- CCPulse+ now supports a new type of view, Query-Based view. These reports are built from the Genesys Info Mart (GIM) database and require GIM release 7.2 or later. The resulting view looks similar to an existing CCPulse+ historical view, but the content is defined by a query. The predefined set of queries must be installed from the Reporting Templates 7.2 DVD.
- You can configure how often the Current State statistics are refreshed in a CCPulse+ view.
- Improved performance enables CCPulse+ to handle more real-time statistics and reduces its use of system resources.
- Support for Citrix AccessSuite 4.0 operating system has been added.
- Support for Windows 2000 SP 4 or higher, Windows XP SP1 or higher, and Windows Server 2003 has been added.
- Support for Windows NT operating system has been discontinued.

CCPulse+ 7.1 CCPulse+ 7.1 introduced the following feature:

- CCPulse+ 7.1 supports Open Media statistics.

CCPulse+ 7.0.2 CCPulse+ 7.0.2 introduced the following features:

- The ability for CCPulse+ to connect to a backup DB Server, if specified.
- The display of information about the individual agents that make up a virtual agent group.
- Within the Template Wizard, you can now rearrange statistical groups and the statistics within the groups by using drag-and-drop operations. Also, you can substitute one stat type for another in metric definitions.

CCPulse+ 7.0.1 CCPulse+ 7.0.1 introduced the following new features:

- Advanced view and workspace management
- Customized printing capability
- Formula-based custom statistic definition
- Increased allowable length of custom statistic names
- Support for fax and call-processing DNs
- Ability to display agent skills in the Extended Current Status window
- In the Extended Current Status window, CCPulse+ can optionally display reasons for agents being in a specific state—typically, NotReady—if reason-code functionality is provided by the desktop.

CCPulse+ 6.5 CCPulse+ 6.5 introduced the following new features:

- The CCPulse+ Application object points to Data Mart, as well as Stat Server, to generate historical views.

- Logged out agents can be hidden from both the Views and Call Center Objects panes of the CCPulse+ main window.
- CC Pulse 6.1, Tier III** The third and subsequent minor releases of CC Pulse 6.1 introduced the following new features:
- Ability to display DN alias instead of DN@switch format
 - Support for silent installations
 - Support on Windows XP and Windows 2000
 - Reporting Service Pack
- CC Pulse 6.1, Tier II** The second release of CC Pulse 6.1 corrected known problems.
- CC Pulse 6.1, Tier I** The first release of CC Pulse 6.1 introduced the following new features:
- Customizable templates, thresholds, and actions
 - Customizable user interface
 - Support on the Windows NT SP6, Windows 2000, and Windows XP platforms
 - Transfer of configuration options from `callcenter.ini` file to the application component
 - Cold standby timeout
- CC Pulse 6.0** The CC Pulse 6.0 release introduced the following new features:
- Extended Current Status window
 - Threshold Wizard
 - Action Wizard
 - Dynamic configuration changes
 - CC Pulse configuration wizards

Changes to Configuration Options and Runtime Parameters

Review the runtime parameters and configuration options—especially log options, which changed significantly—for each applicable Reporting component:

- [Table 29](#) lists the new configuration options that were incorporated into Reporting releases from 7.1 to 7.5.x. Refer to the “Configuration Options” chapters in the *Reporting 7.2 Data Sourcer User’s Guide* and the “Fine-Tuning CCPulse+ Configuration” chapter in the *Reporting 7.5 CCPulse+ Administrator’s Guide* for complete option descriptions.

For the `keep-startup-file` configuration option that was incorporated into Reporting release 7.1, refer to the “Configuration Options” chapter in the

Reporting 7.1 Data Sourcer User's Guide and the “Common Log Options” chapter in the *Reporting 7.1 ETL Runtime User's Guide*. These sources provide information about how this option can be used in the Data Sourcer and ETL Runtime Reporting components.

- **Table 30** lists the prior changes for specific components from Reporting 6.x to Reporting 7.0.x.

For a complete description of the configuration options for these components, refer to the “Configuration Options” chapter in the *Reporting 7 Data Sourcer User's Guide* and to both the “Configuration Options” and “Runtime Parameters” chapters in the *Reporting 7 ETL Runtime User's Guide*. For CCPulse+ option descriptions, refer to the “Fine-Tuning CCPulse+ Configuration” chapter in the *Reporting 7 CCPulse+ Administrator's Guide*.

Table 29: Option and Parameter Changes from 7.1 to 7.5.x

Component Name	[Section] Option Name	Type of Change	Occurred in Release #	Details
CCPulse+	[Workspace] EnableAgentCapacity	New option	7.5.1	Enables or disables the receipt of capacity per media information from Stat Server for individual agents in the CCPulse+ workspace.
	[Workspace] EnableAgentCapacity Status	New option	7.5.1	Enables or disables the display of agent or agent group capacity information in the object tree.
	[Workspace] EnableAgentGroup Capacity	New option	7.5.1	Enables or disables the calculation of capacity per media information by CCPulse+ for agent groups in the workspace. Default value: false
	[CustomStatistic] MediaTypes	New option	7.5.1	Populates the drop-down list of available media types in the Media filter section of the Properties dialog box for the CurrentAgentState statistical category. Default value: "voice"

Table 29: Option and Parameter Changes from 7.1 to 7.5.x (Continued)

Component Name	[Section] Option Name	Type of Change	Occurred in Release #	Details
CCPulse+ (continued)	[Workspace] UseStatServerVirtual Groups	New option	7.5	Specifies the number of seconds, from 0 to 120, that logged-out agents remain visible in a real-time V/AG dynamic membership view. Default value: false
	[View] DelayBeforeRemoval	New option	7.5	Specifies the number of seconds that logged-out agents remain visible in a real-time V/AG dynamic membership view. Default value: 15 (seconds)
	[View] MaxNumberOfAgents	New option	7.5	Specifies the maximum number of agents that CCPulse+ displays in a real-time V/AG dynamic membership view. Default value: 75
	[Workspace] SafeScriptingMode	New option	7.2	Specifies whether CCPulse+ uses a separate thread to execute VB scripts. Default value: false
	[Storage] QueryStorageFullPath	New option	7.2	Defines the location of the XML file in which CCPulse+ queries are stored. No default value.
	[CustomStatistic] ExtendedCurrentStatus	New option	7.2	Enables CCPulse+ to display reasons in current state statistics that are provided through agent views. Default value: false
	CustomStatistic	New section	7.2	Holds one configuration option to affect the display of custom statistics within the CCPulse+ interface.

Table 29: Option and Parameter Changes from 7.1 to 7.5.x (Continued)

Component Name	[Section] Option Name	Type of Change	Occurred in Release #	Details
Data Sourcer	[collector] chunk-file-format	New option	7.2	Specifies one of two supported file formats for the chunk file. Default value: "text"
	[collector] emergency-save-directory	Name changed	7.2	Former option name is sql-save-path. The change in the option name results from changes in the implementation and related algorithm.
	[collector] max-chunk-size	New option	7.2	Specifies the maximum chunk size that Data Sourcer will process. Default value: 2,000,000
	[collector] use-prepared-statements	Option removed	7.2	
	[log] keep-startup-file	New option	7.1	Default value: false
ETL Runtime	[log] keep-startup-file	New option	7.1	Default value: false

Table 30: Option and Parameter Changes from 6.x to 7.0.x

Component Name	[Section] Option Name	Type of Change	Occurred in Release #	Details
CCPulse+	[UserInterface] ShowDurationBeforeStatus Name	New option	7.0.2	Specifies the format by which CCPulse+ displays information about current status in the Views pane. Default value: false
	[UserInterface] ShowStatusReasons	New option	7.0.1	Configures CCPulse+ to display data that is attached to a TEvent in the form of reason codes. Default value: false

Table 30: Option and Parameter Changes from 6.x to 7.0.x (continued)

Component Name	[Section] Option Name	Type of Change	Occurred in Release #	Details
CCPulse+ (continued)	[Workspace] CurrentStateEnable	New option	7.0.1	Enables or disables the current state for all configuration objects that are selected for monitoring in the Call Center Objects pane. Default Value: true
	[Workspace] WorkspaceAutoLoad	New option	7.0.1	Loads the last workspace that was used upon start. Set to false to mimic 6.5 behavior.
	[UserInterface] ShowAgentLoginID	New option	7.0.1	Displays the agent's login ID in the Extended Current Status window. Default value: true
	[UserInterface] ShowAgentSkills	New option	7.0.1	Displays the skills that are associated with selected agents in the Extended Current Status window. Default value: false
	[IconStyle] DNLoggedOut	New option	6.5	Displays one of three styles of logged-out icons by using the DNLoggedOut option. Default value: 6.1.301.04
	[UserInterface] EnableDNAliases	New option	6.5	Displays either DN numbers or DN aliases in the CCPulse+ workspace. Default value: true
CCPulse	[Storages] StatProfileStorage-FullPath	New option	6.0	Defines the location of statprofile.cfg.
Data Sourcer	[collector] data-excess-high-threshold	New option	7.0.1	Default value: 95 (percent of memory queue size)
	[collector] data-excess-low-threshold	New option	7.0.1	Default value: 65 (percent of memory queue size)

Table 30: Option and Parameter Changes from 6.x to 7.0.x (continued)

Component Name	[Section] Option Name	Type of Change	Occurred in Release #	Details
Data Sourcer (continued)	[collector] data-flow-checkout-interval	New option	7.0.1	Default value: 2 (minutes)
	[collector] data-flow-timeout	New option	7.0.1	Default value: 20 (minutes)
	[collector] person-presentation-format	New option	7.0.1	Default value: %l %f (last/first name)
	[collector] create-sample-templates	New option	6.1	Default value: true
	[collector] use-prepared-statements	New option	6.1	Default value: true for Oracle RDBMSs, false otherwise.
	[log-control] log-buffering log-check-interval log-file-name log-file-size log-remove-old-files	Replaced by log section	6.0	Refer to “General Log Option Changes on page 73 for a listing of the common options for all 6.0+ Genesys servers.
ETL Runtime	[Not applicable for runtime parameters] aggQuota	New option	7.0.2	Specifies the number of aggregations that ETL Runtime can perform simultaneously.
	chunkBufferQuota	New option	7.0.2	Specifies the threshold for the number of statistics that ETL Runtime may buffer in memory.
	chunkQuota	New option	7.0.2	Specifies the number of parsed data chunks that ETL Runtime may buffer in memory.
	chunksAtOnce	New option	7.0.2	Specifies the number of data chunks that ETL Runtime can read in a single read operation from a single ODS source.

Table 30: Option and Parameter Changes from 6.x to 7.0.x (continued)

Component Name	[Section] Option Name	Type of Change	Occurred in Release #	Details
ETL Runtime (continued)	[Not applicable for runtime parameters] communication-alarm	New option	7.0.2	Indicates that ETL Runtime will send one of two events to SCS upon detecting changes in connectivity to constituent ODSs.
	deadlockThreshold	New option	7.0.2	Specifies how often ETL Runtime checks its threads for deadlocks.
	levelOfLog	New option	7.0.2	Specifies the detail level of log messages that ETL Runtime generates for the Transformation, Aggregation, and Purge modules.
	maxLevelOfAgg	Option removed	7.0.2	
	maxNumberOfChunksInRead Queue	Option removed	7.0.2	
	chunkBufferQuota	New option	7.0.2	Specifies the threshold for the number of statistics ETL Runtime may buffer in memory.
	chunkQuota	New option	7.0.2	Specifies the number of parsed data chunks that ETL Runtime may buffer in memory.
	chunksAtOnce	New option	7.0.2	Specifies the number of data chunks that ETL Runtime can read in a single read operation from a single ODS source.
	communication-alarm	New option	7.0.2	Indicates that ETL Runtime will send one of two events to SCS upon detecting changes in connectivity to constituent ODSs.

Table 30: Option and Parameter Changes from 6.x to 7.0.x (continued)

Component Name	[Section] Option Name	Type of Change	Occurred in Release #	Details
ETL Runtime (continued)	[Not applicable for runtime parameters] deadlockThreshold	New option	7.0.2	Specifies how often ETL Runtime checks its threads for deadlocks.
	maxNumberOfChunksInWriteQueue	Option removed	7.0.2	
	maxNumberOfConnToDist	Option removed	7.0.2	
	maxNumberOfWriteMonitorsPerView	Option removed	7.0.2	
	noCheckTablesForFolderViews	Option removed	7.0.2	
	noSrcObjects	Option removed	7.0.2	
	numberOfDataReadersPerSource	Option removed	7.0.2	
	numberOfWriters	New option	7.0.2	Specifies the number of threads that ETL Runtime dedicates to writing data chunks to Data Mart.
	reinitAfterException Timeout	Option removed	7.0.2	
	setMinimalDaysIn FirstWeek	New option	7.0.2	Specifies which days of the new year will make up the first Data Mart week.
	srcStartReading Timeout	Option removed	7.0.2	
	surviveLossOfA Source	New option	7.0.2	Determines ETL Runtime's response to exceptions in communication with constituent ODSs.
	syncDimWithGlobalCatalog Timeout	Option removed	7.0.2	

Table 30: Option and Parameter Changes from 6.x to 7.0.x (continued)

Component Name	[Section] Option Name	Type of Change	Occurred in Release #	Details
ETL Runtime (continued)	[Not applicable for runtime parameters] noCheckTablesForFolder Views	Option removed	7.0.2	
	CfgUserPasswordEncrypted	New option	7.0.1	Encrypted version of the password for the Configuration Server user that is specified by CfgUserName .
	data-excess-alarm	New option	7.0.1	Indicates that ETL Runtime will send one of two events to SCS regarding variations in the data transfer rate between ODS and Data Mart.
	data-excess-check-interval	New option	7.0.1	Specifies how often ETL Runtime checks for overage in the number of data rows that are transferred.
	data-excess-threshold	New option	7.0.1	Specifies the maximum number of data rows that ETL Runtime can transfer during an interval.
	data-flow-alarm	New option	7.0.1	Indicates that ETL Runtime will send one of two events to SCS regarding changes in data flow between ODS and Data Mart.
	data-flow-check-interval	New option	7.0.1	Specifies the frequency with which ETL Runtime checks for data flow from ODS to Data Mart.

Table 30: Option and Parameter Changes from 6.x to 7.0.x (continued)

Component Name	[Section] Option Name	Type of Change	Occurred in Release #	Details
ETL Runtime (continued)	[Not applicable for runtime parameters] data-flow-timeout	New option	7.0.1	Specifies how much time can pass before ETL transformation must resume a previously suspended data transfer, before logging a message indicating a data-flow problem.
	data-excess-check-interval	New option	7.0.1	Specifies how often ETL Runtime checks for overage in the number of data rows transferred.
	keepOpenCursorsForAgg	Option removed	7.0.1	
	passEncrypted	New option	7.0.1	Encrypted version of the Data Marts user's password.
	setFirstDayOfWeek	New option	6.5	Specifies the start day of the week for week-level aggregations.
	CfgUser	New option	6.1	Specifies the name of a Configuration Server user.
	CfgUserPassword	New option	6.1	Specifies the password for the Configuration Server user that is specified by CfgUserName
	dba_pass	New option	6.1	Specifies the password for the administrative RDBMS user.
	dba_user	New option	6.1	Specifies an administrative user name for the RDBMS in which the Data Mart is located.
	reverse_password	New option	6.1	Used in the TAT algorithm for generating passwords for tenant accounts in a multi-tenant environment.

Table 30: Option and Parameter Changes from 6.x to 7.0.x (continued)

Component Name	[Section] Option Name	Type of Change	Occurred in Release #	Details
ETL Runtime (continued)	[Not applicable for runtime parameters] tenants_shortcut	New option	6.1	Specifies how the TAT module generates account names.
	transOnce	New option	6.1	If presented at command line, ETL Runtime exits after aggregating all available data.
	keepOpenCursorsForAgg	New option	6.0	Speeds up subsequent aggregations by not closing cursors.



Chapter

15

Reporting Migration Procedures

This chapter discusses the following migration topics:

- [Overview, page 211](#)
- [Migrating CC Analyzer 7.x to 7.2.x, page 212](#)
- [Migrating CC Analyzer 6.x to 7.x, page 214](#)
- [Migrating CC Pulse 6.x/CCPulse+ 7.x to CCPulse+ 7.5.x, page 215](#)

Overview

Migration processes may include installing new software, converting data, and/or changing the values or properties of certain parameters.

CC Analyzer Migration Tasks

These are the major tasks in migrating your 6.x or 7.x CC Analyzer environment:

1. Migrate Configuration Server.
2. Back up ODS and Data Mart databases. (You will be able to restore your existing environment should any part of migration to 7.2 fail.)
3. Install CC Analyzer 7.2.
4. Start each CC Analyzer 7.2 component.

Note the following:

- After migrating, Genesys assumes you will use the same relational database management system that you used prior to migration. For example, you would not switch from Oracle to Microsoft SQL or even upgrade the Oracle version from 8.0.3 to 8.1.7 *during migration*.

- If necessary, upgrade either your operating system or your RDBMS *before* migrating your Reporting environment: make sure your current environment is functioning correctly before migrating Reporting. It is not advisable to bring in a new server during migration.
- Genesys assumes that you have not customized the canned templates. If that is the case, completion of the following migration steps will take anywhere from an hour to several days depending on the complexity of the Reporting environment in your contact center. See the “Staged Rollout” notes throughout this chapter if you are conducting a pilot or are rolling out Reporting 7.x in stages.

**CCPulse+
Migration
Tasks**

For CC Pulse/CCPulse+, the migration is straightforward.

See “Migrating CC Pulse 6.x/CCPulse+ 7.x to CCPulse+ 7.5.x” on [page 215](#) for details.

Migrating CC Analyzer 7.x to 7.2.x

Use the instructions in this section to migrate CC Analyzer release 7.0 or 7.1 to release 7.2.x.

Note: North American customers must upgrade Data Mart to the latest generally available release of Data Mart 7.2.x to comply with the US Energy Policy Act of 2005 for Daylight Savings Time.

**To Migrate
CC Analyzer 7.x**

1. Migrate the Configuration Server.

This step is optional because CC Analyzer 7.2.x is fully compatible with Configuration Server 7.0 and 7.1.

If you decide to migrate Configuration Server, see the detailed instructions in Chapter 5, “Setup of Migration Environment.”

2. If you plan to deploy Data Sourcer 7.2.x, upgrade your Stat Server application to the latest generally available release of Stat Server 7.2 (or higher) and adjust its configuration settings. Refer to the “Stat Server Migration” chapter of this guide for instructions.

3. Stop all CC Analyzer applications and any other applications that are connected to the ODS and Data Mart.

4. Back up your current ETL Runtime directory. Save all *.properties files.

5. Back up each ODS and Data Mart in your environment.

Staged Rollout: Back up each ODS in your particular Data Mart environment.

6. Install all 7.2.x components of Historical Reporting except Data Sourcer, which is optional. See “Configuration and Installation Issues” on [page 186](#) for notes about your current application objects and configuration options.

Genesys recommends that you keep your current Data Sourcer version unless you require and are ready to deploy the new High Availability functionality of Historical Reporting. See “To Enable High Availability” on [page 213](#) for instructions. If you decide to deploy Data Sourcer release 7.2.x, upgrade your Stat Server to the latest generally available release of Stat Server 7.2. See the “Stat Server Migration” chapter of this guide for migration instructions.

7. Start Historical Reporting and verify that it functions properly.
 - a. Start all Data Sourcer components of Historical Reporting 7.2.x, if any are deployed, and analyze the Data Sourcer log files for errors. Upon first start, Data Sourcer automatically converts ODS data and structures.
 - b. Run all ETL Runtime components of Historical Reporting 7.2.x in Transformation-and-Aggregation mode or in Transformation Only mode. Upon first start, ETL Runtime automatically converts Data Mart data and structures.
 - c. After roughly 30 minutes, (or 1 hour if the Internet Contact Solution is involved), check the ETL Runtime log files for exceptions (search for the string EXCEPT).

Refer to the *Reporting 7.5 Deployment Guide* for information about starting Historical Reporting.

8. **Staged Rollout:** Repeat Steps 2–5 for each stage of your migration.

To Enable High Availability

To benefit from the High Availability (HA, or no loss) of historical data that is implemented in Historical Reporting 7.2:

1. Make the Data Mart and ODS databases highly available.

Refer to the *Reporting 7.5 Deployment Guide* for guidelines, and work with your DBA on your specific implementation of database HA.
2. Upgrade your current Data Sourcer application to release 7.2.x, if it has not been upgraded already.
3. Deploy a backup Data Sourcer application:
 - a. Configure a new Data Sourcer Application object in the Configuration Manager.
 - b. Specify this new Application object as a Backup Server in Hot Standby mode for your current (primary) Data Sourcer application.
 - c. Install the backup Data Sourcer application on a host other than the computer that is running your primary Data Sourcer application.
4. Upgrade your historical reporting Stat Server application to the latest generally available release of Stat Server 7.2 (or higher), if it has not been upgraded already.
5. Deploy a backup Stat Server application, if it is not deployed already:
 - a. Configure a new Stat Server Application object in the Configuration Manager.

- b. Specify this new Application object as a Backup Server in Warm Standby mode for your current (primary) Stat Server application.
 - c. Install the backup Stat Server application on a host other than the computer that is running your primary Stat Server application.
6. In the Application objects for *both* the primary and backup Stat Servers:
 - a. In the statsserver section, create a new option that is named `accept-clients-in-backup-mode`.
 - b. Set the option value to `yes`.
7. Run the primary and backup Data Sourcer applications simultaneously. Refer to the *Reporting 7.5 Deployment Guide* for information about Reporting HA.

Migrating CC Analyzer 6.x to 7.x

Use the instructions in this section to migrate CC Analyzer release 6.x to release 7.0, 7.1, or 7.2.

If you are using the 6.1 version of Reporting templates, request the Genesys 6.5 Reporting Service Pack from Genesys Technical Support before migrating your historical reporting environment. Though deploying this Service Pack is not mandatory, you may benefit from the improved definitions for `ServiceFactor` and other metric calculations (such as all Total metrics) if you do deploy it. The Service Pack changes all `Total` metrics (`Total_Calls`, `Total_Calls_On_Hold`, and so forth) so that they are based on the number of status occurrences rather than on the number of DN actions. Chapter 16, “Reporting Service Pack 6.5,” on [page 217](#) describes its use. If you are already using the 6.5 version of the Reporting templates, no template upgrade is necessary.

Migration occurs automatically for CC Analyzer 6.x components opened in a Framework 7.x environment. You do not need to run a special script.

To Migrate CC Analyzer 6.x

1. Migrate the Configuration Server.
Refer to Chapter 5, “Setup of Migration Environment,” for detailed instructions.
2. Stop all CC Analyzer applications and any other applications that are connected to the ODS and Data Mart.
3. Back up each ODS and Data Mart in your environment.
Staged Rollout: Back up each ODS in your particular Data Mart environment.
4. Install all 7.x components of Historical Reporting. See “Configuration and Installation Issues” on [page 186](#) for notes about your existing application objects and configuration options.

Genesys recommends that you deploy Data Sourcer release 7.1 unless you require and are ready to deploy the new High Availability functionality of Historical Reporting. See “To Enable High Availability” on [page 213](#) for instructions. If you decide to deploy Data Sourcer release 7.2, upgrade your Stat Server to the latest generally available release 7.2. See the “Stat Server Migration” chapter in this guide for migration instructions.

5. Start Historical Reporting and verify that it functions properly.
 - a. Start all Data Sourcer components of Historical Reporting 7.x and analyze the Data Sourcer log files for errors. Upon first start, Data Sourcer automatically converts ODS data and structures.
 - b. Run all ETL Runtime components of Historical Reporting 7.x in Transformation-and-Aggregation mode or in Transformation Only mode. Upon first start, ETL Runtime automatically converts Data Mart data and structures.
 - c. After roughly 30 minutes (1 hour if the Internet Contact Solution is involved), check the ETL Runtime log files for exceptions (search for the string EXCEPT).

Refer to the *Reporting 7.5 Deployment Guide* for information about starting Historical Reporting.

6. **Staged Rollout:** Repeat Steps 2–5 for each stage of your migration.

Migrating CC Pulse 6.x/CCPulse+ 7.x to CCPulse+ 7.5.x

The procedure for migrating CC Pulse/CCPulse+ to 7.5.x is straightforward:

**To Migrate
CC Pulse/
CCPulse+**

1. Migrate Configuration Server to release 6.1 or higher. You cannot use Configuration Server 6.0.
See the detailed instructions in Chapter 5, “Setup of Migration Environment.”
2. Make sure that your Stat Server release is 6.5 or higher.

Note: Certain templates may require a later release of Stat Server than 6.5. Refer to the *Genesys 7 Interoperability Guide* and the *Genesys 8 Interoperability Guide* for information on the compatibility of Genesys products with various Configuration Layer Environments; Interoperability of Reporting Templates and Solutions; and *Gplus Adapters Interoperability*.

3. Stop all CC Pulse/CCPulse+ applications.
4. Save a copy of your storage files.
5. Uninstall CC Pulse/CCPulse+.

6. Configure and install CCPulse+ 7.5.x.
7. **Optional:** If you intend to use the historical aspect of CCPulse+ against an existing Data Mart, migrate your existing Historical Reporting environment, by following the appropriate procedure in this chapter for your current environment.
8. Start CCPulse+ and verify that it functions properly.
9. **Optional:** If you want to use customized templates, thresholds, or action scripts from the copy of your storage files that you saved in Step 4, use the CCPulse+ Import/Export Utility to add them to the new storages. Use of this utility is described in *Reporting 7.5 CCPulse+ Help*.

Notes: The CCPulse+ templates that are created by CCPulse+ 7.5.x are not fully compatible with CCPulse+ 7.2 (and earlier). If these 7.5.x templates are used with earlier releases of CCPulse+, many statistics will display incorrect values of -1 in the View.

CCPulse+ 7.5.x is fully compatible with templates that are created by earlier releases of CCPulse+.



Chapter

16

Reporting Service Pack 6.5

Genesys 6.5 Reporting Service Pack is a template migration utility, which redefines the metrics in existing solution-specific pre-6.5 Reporting templates. This chapter provides information for administrators who deploy the Genesys 6.5 Reporting Service Pack.

Notes: The Genesys 6.5 Reporting Service Pack is recommended for templates migration from releases 5.x, 6.0, or 6.1 to release 6.5.

To migrate templates from releases 6.5 or 7.x to a higher release 7.x, use the Reporting Wizard of the particular 7.x release to which you are migrating the templates.

This chapter includes the following sections:

- [Overview, page 218](#)
- [Considerations and Recommendations, page 219](#)
- [Analyzing Differences in Definitions, page 224](#)
- [Deployment Planning, page 227](#)
- [Running the Upgrade, page 229](#)
- [Restoring from Backup, page 233](#)
- [Stat Type Listing, page 233](#)

These are among the topics addressed in this chapter:

- Two options to consider: upgrade `Service Factor` and upgrade stat types.
- Migrations that must be performed before deploying the Service Pack.
- Genesys applications that **must** be running and those that **must not** be running.
- Deploying and running this Service Pack.
- Restoring your environment if you decide to return to your previous metric definitions.

Note: Upgrading stat types in this Service Pack changes the definitions of all Total metrics (Total_Calls, Total_Calls_On_Hold, and so forth) so that they are based on the number of status occurrences rather than on the number of DN actions.

Overview

The Reporting Service Pack contains a set of upgrades that enable your migrated CC Analyzer environment to collect historical information based on the metric definitions provided in the 6.5 release of Genesys solutions. If you have migrated or are planning to migrate your solution environment to 6.5, you might want to run this Service Pack to benefit from the enhanced metric definitions provided with the Genesys 6.5 release. Deploying this Service Pack is not mandatory in completing your Genesys migrations. Information in this chapter will help you to decide whether to roll out this Service Pack, given its changes.

Deployment Processes

These sections will guide you through the decision-making and deployment processes:

- “Considerations and Recommendations” on [page 219](#) present issues to consider before deploying this Service Pack.
- “Analyzing Differences in Definitions” on [page 224](#) will assist you with your analysis.
- “Deployment Planning” on [page 227](#) will help you prepare your environment for a smooth execution.
- “Running the Upgrade” on [page 229](#) provides step-by-step instructions for executing the Service Pack.
- “Restoring from Backup” on [page 233](#) describes how to return to your previous environment if you choose this route.

Do not run this Service Pack if any of these conditions exist at your site(s):

- You have not migrated your Reporting environment to 6.1, Tier II (with a 6.5 Stat Server) or 6.5.
- The Data Sourcers in your Reporting Environment are all IS Data Sourcers (for a Contact Center Database deployed by the Internet Contact Solution), or
- You are installing your Genesys solution for the very first time.

Genesys Enterprise Routing (ERS) 6.5, Outbound Contact 6.5, and Internet Contact Solution 6.5 are bundled with Framework 6.5 and Reporting 6.1 as well as with Reporting 6.5. Your solution 6.5 DVD includes 6.5 layout templates with metrics representative of the types of data that might be useful. These layout templates specify the metrics to be gathered and how they are

gathered. This Service Pack does not change the quantity or list of metrics in each template, but it does affect how Data Sourcer gathers data.

Definitions Deploying this Service Pack applies improved definitions to the following:

- Statistical (stat) types.
- Service Factor metric provided in reports that typically measure route point and queue performance.

Please understand that this utility **does not** upgrade CC Analyzer components defined within the Configuration Server, nor does this utility upgrade your 6.0 Operational Data Storage (ODS) or Data Mart databases to be 6.5 (or 6.1) compliant. This utility does not change the values of previously collected data. Rather, this utility updates metadata, that is, the rules that specify how data is collected.

Refer to the Chapter 15, “Reporting Migration Procedures,” on [page 211](#) earlier in this document for information about migrating CC Analyzer data and components.

Considerations and Recommendations

This section addresses issues with which you should be familiar before rolling out the Genesys 6.5 Reporting Service Pack. The issues include:

- Data collection
- Service Factor changes
- Stat type changes
- Shared Stat Server implications
- Shared stat type implications
- Effect on report layouts, Brio report templates, and Brio reports

This section also provides recommendations on how to deploy most effectively this Service Pack.

Data Collection Must Stop

Deployment of this Service Pack requires that Stat Server and Data Sourcer be stopped. This means that historical data collection ceases during deployment. You will want to plan to run this utility during non-peak hours to minimize the loss of data. You may, however, roll out this upgrade in stages by upgrading only selected ODSs at a time and saving the upgrade of other ODSs for a later time.

Note: Deployment of this Service Pack **will not** affect or cause the loss of preexisting historical data in your ODS.

Service Factor Considerations

The Service Factor metric is used in Brio report templates to measure queue and route point performance. As defined in previous releases, this metric measured the percentage of **distributed** calls falling within a specified service-level threshold. Its prior definition was:

$$\frac{(100\% * nDistributedInTh1)}{(nCallsEntered - TotalShortAbandoned)}$$

This definition has changed in the 6.5 release to better align with CC Pulse's definition, which measures the percentage of **answered** calls falling within the threshold:

$$\frac{(100\% * nAnsweredInTh1)}{(nAnswered + nAbandoned - nAbandonedInTh2)}$$

Both formulas yield meaningful but different results. You must carefully evaluate which Service Factor formula suits your needs before running the Service Pack. (The pack provides the Service Factor option to upgrade this metric.) Also note to reset time ranges for this metric in DMA if you customized them.

This change affects how the N_DISTRIB_IN_TR metric is measured in the QUEUE, ROUTEPOINT, and GROFQUEUES layout templates and how the N_CALL_DIST_T metric is measured in the CC_Q, CC_RP, and CC_GRP layout templates.

Previously, these metrics were based on the Total_Calls_Distributed_In_Threshold stat type. In release 6.5, these metrics are based on the Total_Calls_Answered_In_Threshold stat type. Also, the change in these metrics' definition will yield incorrect data in those 6.5 Brio reports run using data spanning time periods both before and after the upgrade. Service Factor may exceed 100%.

Figure 7 on [page 221](#) shows the 6.5 metric definition in Data Modeling Assistant (DMA). Notice that the name of the metric no longer reflects its actual meaning.

Shared Stat Servers

Stat type definitions are updated in Data Sourcer and in Stat Server. If another application (such as CC Pulse) uses the Stat Server assigned to Data Sourcer, then it too will calculate metrics based on the improved stat type definitions. See [Figure 7](#).

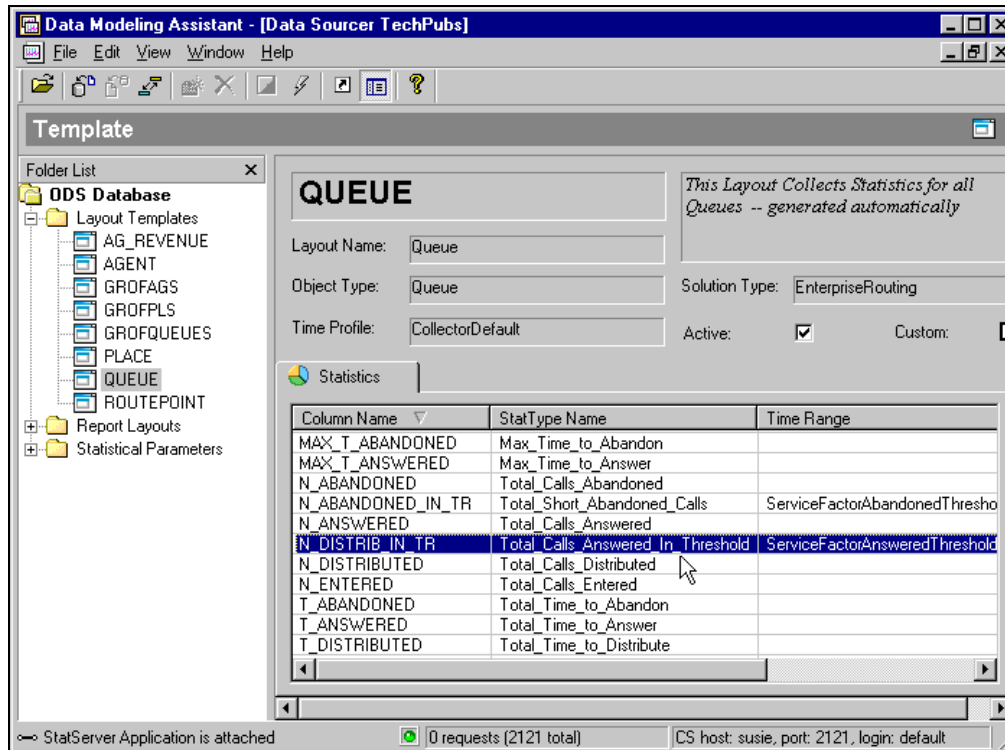

Figure 7: The N_DISTIB_IN_TR Metric Changes Stat Types in Release 6.5

Stat Type Considerations

The pre-6.5 solution-specific reports had some known limitations, including some averages and percentages that were miscalculated over small time intervals, such as over a 15-minute period.

New Statistical Categories

To resolve these issues, two new statistical categories were introduced in the 6.1 and 6.5 Stat Server:

- TotalAdjustedNumber
- TotalAdjustedTime

Refer to “Calculation Rules for Statistical Categories” in the *Reporting Technical Reference Guide for the Genesys 6.5 Release* for an in-depth explanation, with examples, of these categories.

These statistical categories properly count finished statuses at the end of each interval. The general rule followed by the 6.5 canned reports is that only finished statuses or actions are counted for the Agent and Place reports, allowing the proper calculation of percentages and averages. However, the total time of a single status for 15-minute time interval, for example, can exceed 15 minutes if this status was started in a previous time interval.

When you select the Upgrade Stat Types option, the upgrade utility adjusts **all** stat type definitions found in the XML files you select to upgrade to their 6.5 stat type definition—whether or not the definition changed between

releases—just to be thorough. You should decide whether you want the benefit from the new metric definitions before starting the upgrade process, for after you upgrade your 6.5 reports may generate different results from those generated in previous releases: the changes are especially visible in the smaller time intervals. [Table 31](#) shows those metrics that changed most significantly:

Table 31: Metrics Most Affected by Stat Type Changes

Data Mart Metric	Stat Type Name	Corresponding ODS Layout Template
AV_T_NOT_READY	Total_Not_Ready_Number	AGENT, AGENT GROUP, PLACE, PLACE GROUP
AV_T_WAIT	Total_Wait_Number, Total_Wait_Time	AGENT, AGENT GROUP, PLACE, PLACE GROUP
AV_T_WORK	Total_Work_Number, Total_Work_Time	AGENT, AGENT GROUP, PLACE, PLACE GROUP
N_NOT_READY	Total_Not_Ready_Number	AGENT, AGENT GROUP, PLACE, PLACE GROUP
N_NOT_READY_CUST	Total_Not_Ready_Number	CC_AG, CC_GRAG
N_WAIT	Total_Wait_Number	AGENT, AGENT GROUP, PLACE, PLACE GROUP
N_WAIT_CUST	Total_Wait_Number	CC_AG, CC_GRAG
N_WORK	Total_Work_Number	AGENT, AGENT GROUP, PLACE, PLACE GROUP
N_WORK_CUST	Total_Work_Number	CC_AG, CC_GRAG
T_NOT_READY	Total_Not_Ready_Time	AGENT, AGENT GROUP, PLACE, PLACE GROUP
T_NOT_READY_CUST	Total_Not_Ready_Time	CC_AG, CC_GRAG
T_WAIT	Total_Wait_Time	AGENT, AGENT GROUP, PLACE, PLACE GROUP
T_WAIT_CUST	Total_Wait_Time	CC_AG, CC_GRAG
T_WORK	Total_Work_Time	AGENT, AGENT GROUP, PLACE, PLACE GROUP
T_WORK_CUST	Total_Work_Time	CC_AG, CC_GRAG

With these stat types, the subject changed from `DNAction` to `AgentStatus`—that is, the source of data for all objects indicated by the stat type stems from the status of an agent rather than the actions of a regular

directory number. Other stat types pick up this subject change too; however, the values reported by the associated metrics do not change as much as they do with the metrics listed in Table 31 on [page 222](#).

Refer to “Statistical Actions and Statuses” in the *Reporting Technical Reference Guide for the Genesys 6.5 Release* for information about the differences between actions and statuses.

You cannot selectively choose which metric definitions you want to upgrade within a layout template using the Service Pack.

Canned and Custom Report Layouts

If you built report layouts based directly on the Genesys-provided layout templates prior to applying this Service Pack, when you deploy this Service Pack, your report layouts will begin collecting metrics based on the improved definitions. You need not re-create report layouts.

For example, in your 6.0 CC Analyzer environment, you created three report layouts based on the ERS-provided AGENT layout template: AgentA, AgentB, AgentC. You migrate your Framework and Reporting environments to 6.5 and 6.1 respectively. You review the changes in the metric definitions between 6.0 and 6.5 and decide you want to use the latter for data collection. After you run this Service Pack having selected the AGENT layout template for upgrade, the AgentA, AgentB, and AgentC report layouts automatically start collecting data based on the new definitions once Data Sourcer is restarted.

If you created report layouts based on customized layout templates, you have to weigh the decision to manually upgrade the stat types in those templates against not running this upgrade at all.

Canned and Custom Brio Report Templates

The canned Brio report templates use the N_DISTRIB_IN_TR metric only to measure service factor. However, if your customized reports use this metric, you may either have to:

- Readjust this metric’s definition to meet your needs.
- Avoid upgrading this metric’s definition.

The Service Factor metric used in the 6.5 canned report templates is now calculated in the Brio report template itself and not, as in previous releases, during aggregation where it was stored in the Data Mart.

Service Factor Metric

You have the following options:

- If you decide to upgrade the Service Factor while running this Service Pack, you must then use the 6.5 Brio report templates.
- If you decide not to upgrade the Service Factor definition, continue to use your current Brio report templates when generating reports to use the corresponding Service Factor definition.

- You also have the option to customize the provided 6.5 Brio report templates and adjust the formula to meet your needs.

Recommendations

Genesys strongly recommends that you:

- Thoroughly analyze the differences in definitions between your current release and 6.5. (See “Analyzing Differences in Definitions” on [page 224](#))
- Upgrade all the layout templates that you use if you decide to deploy this Service Pack.
- Back up your ODS(s) before deploying this Service Pack.
- Upgrade all Data Sourcers used by a single ETL Runtime at the same time.
- Do not run this upgrade utility against IS Data Sourcer.

This Service Pack slightly changes the majority of your stat type definitions. Depending on the release you had just prior to migration, one to two new statistical categories are introduced that more accurately match the metrics collected with your expectations of what those metrics represent. Analyze the differences to determine if the change will seriously impact your analysis of the reports you generate. If you decide to proceed, Genesys recommends upgrading all the layout templates that you use. If, for example, your Reporting environment uses both the `QUEUE` and `ROUTEPOINT` layout templates, select both of them for upgrade. And, if rolling out in stages, upgrade all Data Sourcers used by a single ETL Runtime simultaneously to avoid data discrepancies.

Analyzing Differences in Definitions

With each Genesys release, improvements were made to the solution-provided layout templates. For this reason, it is impractical to list all differences in metric definitions between those releases and the 6.5 release. Rather, this chapter demonstrates how you can determine what the differences are. After analysis, you can decide if you want to update the definitions, and if so, which set of definitions you should update. See the following documents:

- “Stat Server Stat Type Definitions” listed in the *Reporting Technical Reference Guide for the Genesys 6.5 Release*. This discussion provides in-depth descriptions for 6.5 stat types.
- “Stat Type Listing” on [page 233](#) shows the stat types used by each layout template.
- *Reporting 6.5 Data Modeling Assistant Help*.

Comparison of Stat Type Definitions

You can compare stat type definitions used by CC Analyzer in at least three ways:

- Observe your current stat type definitions within DMA and compare them to those listed in the *Reporting Technical Reference Guide for the Genesys 6.5 Release*.
- Observe your current stat type definitions in Stat Server and compare them to those listed in the *Reporting Technical Reference Guide for the Genesys 6.5 Release*.
- Compare an export of definitions for your current layout templates to the comparable Genesys-provided 6.5 layout templates.

Each method is briefly described in the next section.

Methods of Comparing Stat Type Definitions

- Method 1** Open your Data Sourcer application in a DMA document window and select a layout template. The right pane shows the metrics to be collected and their stat type definitions. Double-click a stat type definition to open the **Statistic Wizard-StatTypes** dialog box, which displays the stat type's definition. **Figure 8**, for example, shows the definition for the `Total_Calls_Outbound` stat type. Compare this definition to that in the *Reporting Technical Reference Guide for the Genesys 6.5 Release*. You will notice that the 6.5 definition uses the `TotalAdjustedNumber` statistical category rather than the `TotalNumber` category in this particular example

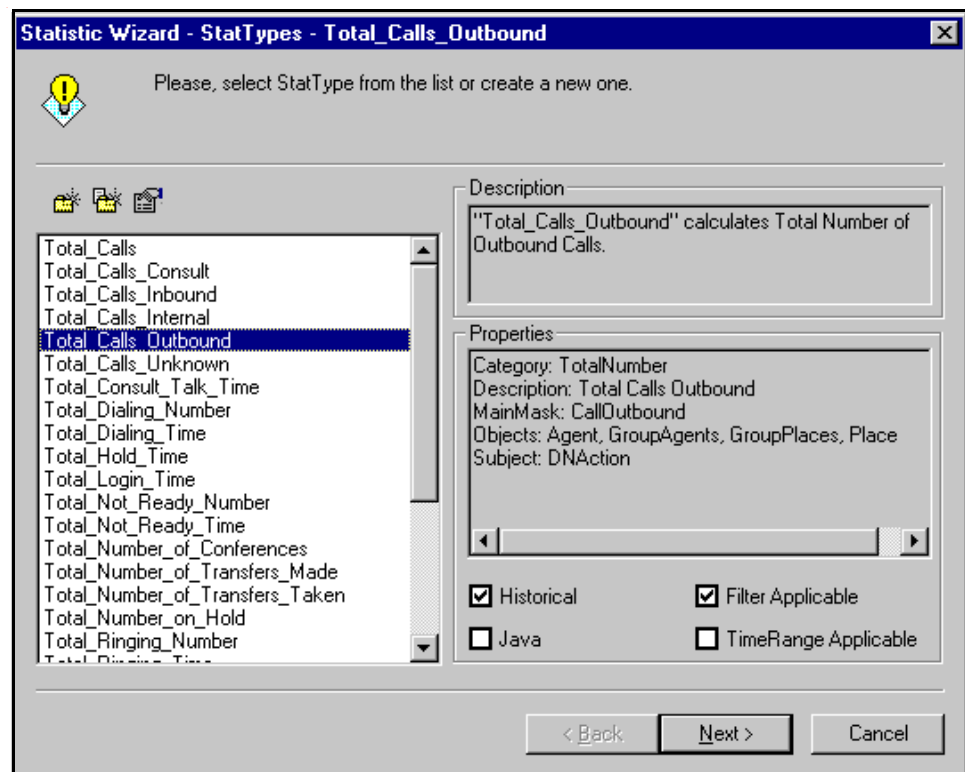

Figure 8: Using the Statistic Wizard to Observe Stat Type Definition

Method 2 From the Configuration Manager, view the application properties of the Stat Server used by your targeted Data Sourcer. At the Options tab, double-click a stat type and note its definition. [Figure 9](#), for example, shows the definition for the Total_Login_Time stat type. Compare this definition to the one in the *Reporting Technical Reference Guide for the Genesys 6.5 Release*. You will notice that the 6.5 stat type definition adds the ~NotMonitored status to its main mask specification.

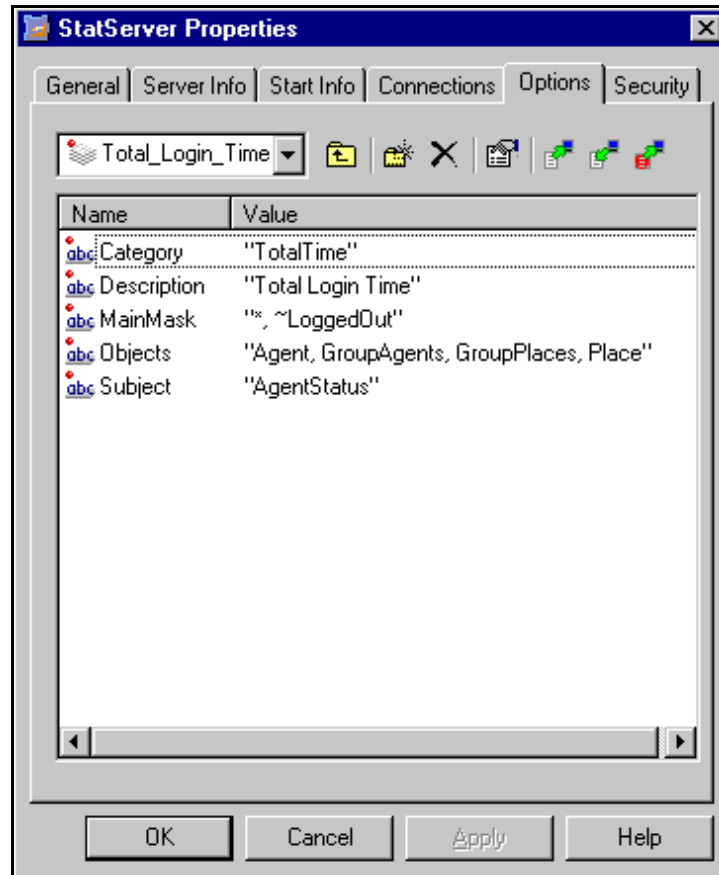

Figure 9: Using the Configuration Manager to Observe Stat Type Definition

Method 3 Using DMA, export a layout template to an XML file and visually compare this file with the one provided by your 7.0 solution. For example, [Figure 10](#) shows two cutaways of the ERS AGENT template in xml format for 6.1 and 6.5. Notice the differences in the Total_Calls_Outbound stat type:

- Statistical category changes from TotalNumber to TotalAdjustedNumber.
- Subject changes from DNAction to AgentStatus.
- No longer distinct by connection ID.
- Statistical Category ID changes from 1 to 40.
- Stat type description is improved.

```

<?xml version="1.0" ?>
- <IM_DataBase Version="6.1">
  - <LayoutTemplate TemplateName="AGENT" LayoutName="Agent Layout" MetagroupClass="100"
    .
    .
  - <StatType StatTypeId="37" StatTypeName="Total_Calls_Outbound" IfHistorical="Yes"
    FiltersApplicable="Yes" TimeRangeApplicable="No" StatusProfileApplicable="No"
    StatTypeDefinition="Category=TotalNumber Objects=Agent, GroupAgents, GroupPlaces, Place
    MainMask=CallOutbound Subject=DNAction Formula=DistByConnID Description=Total Calls
    Outbound" StatCategoryId="1">
    <Description>Total Number of Outbound Calls</Description>
  </StatType>

<?xml version="1.0" ?>
- <IM_DataBase Version="6.5.004">
  - <LayoutTemplate TemplateName="AGENT" LayoutName="Agent Layout" MetagroupClass="100"
    .
    .
  - <StatType StatTypeId="9" StatTypeName="Total_Calls_Outbound" IfHistorical="Yes"
    FiltersApplicable="Yes" TimeRangeApplicable="No" StatusProfileApplicable="No"
    StatTypeDefinition="Category=TotalAdjustedNumber Subject=AgentStatus Objects=Agent,
    GroupAgents, GroupPlaces, Place MainMask=CallOutbound Description=Total number of times
    agent status "Outbound Call" completed" StatCategoryId="40">
    <Description>Total number of times agent status "Outbound Call" completed</Description>
  </StatType>

```

Figure 10: Two Cutaways of AGENT.xml

Deployment Planning

This section describes how to prepare your environment for running this Service Pack.

System Requirements

You can run this utility on the following platforms:

- Windows NT, Service Pack 6
- Windows 2000

Genesys Requirements

Before deploying this Service Pack, you must have already migrated:

- Your Framework environment to 6.5.

- CC Analyzer in your Historical Reporting environment to CC Analyzer 6.1 or later. Specifically, all CC Analyzer Data Sourcer applications that you intend to upgrade must be of version 6.1.012 or later; likewise, all Stat Servers used by these Data Sourcers must be 6.5 or later.

Note: Migrating your solution environment before deploying this Service Pack is not required.

In addition, the set of 6.5 layout templates (in the form of XML files) must be readily available. These 6.5 templates are found on your solution DVD. If you are upgrading more than one solution, you may need to copy each solution's XML files to one dedicated directory.

What Must Be Running

Make sure the following applications are running before deploying this Service Pack:

- The Configuration Server.
- The ODS RDBMS(s) used by the Data Sourcers to be upgraded.
- The DB Servers used by the Data Sourcers for connection to these RDBMSs.

What Must Be Stopped

Stop the following applications before deploying this Service Pack:

- All Data Sourcer applications that you intend to upgrade.
- All Stat Server applications used by these Data Sourcers.
- Any other applications connected to ODS (such as DMA or ETL Runtime).

Note: Close any document windows containing Data Sourcer applications to be upgraded within DMA.

Deployment and Removal

The utility is shipped as a self-extracting archive containing a set of files.

To Unpack the Archive

1. Run the executable file.
The initial dialog box appears (see Figure 11 on [page 229](#)).
2. Provide the path to a directory where you want to extract the files.
3. Click `Unzip`.

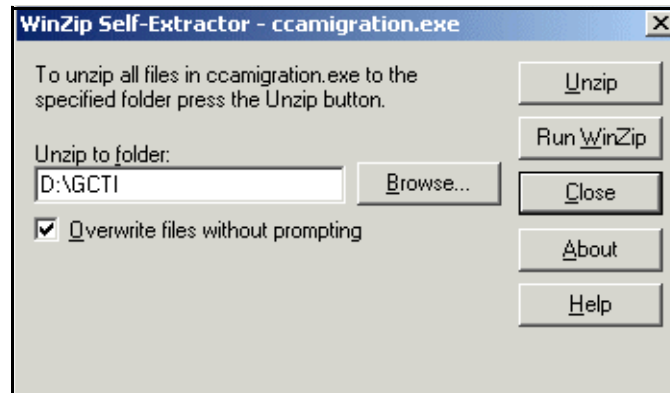

Figure 11: Extracting files from the Reporting Service Pack

To Uninstall the Service Pack

- Delete all the files.

Running the Upgrade

After you decide which options you want from the upgrade, deploy the package, and have the proper applications running or stopped as described in the previous chapter.

To Run the Upgrade

1. Start the `CCA_Migration.exe` executable from its home directory (for example, double-click the file from within Windows Internet Explorer). The utility prompts you to log in to your Configuration Server (see [Figure 12](#)).

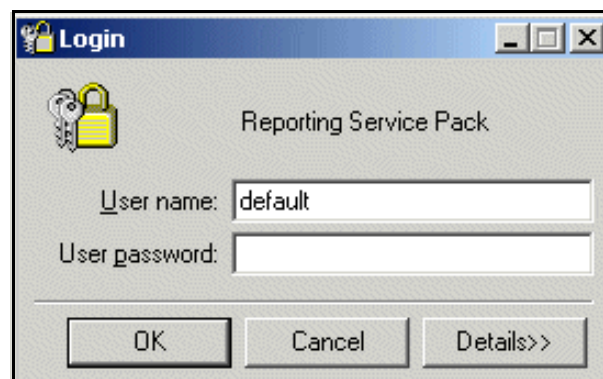

Figure 12: Login Dialog Box

2. Log in to the Configuration Server where your targeted Data Sourcer is registered.
3. Provide the additional connection information listed below by clicking `Details>>`.
 - Host of your Configuration Server

- Port number of your Configuration Server
 - Application name of your Configuration Manager
4. Click **OK** on the **Login** dialog box in Figure 12 on [page 229](#).

When you have successfully logged in, the **Reporting Service Pack** dialog box appears as shown in [Figure 13](#). By default, the utility selects all **CC Analyzer Data Sourcer** applications for upgrade.

Note: **IS Data Sourcer** applications are not displayed.

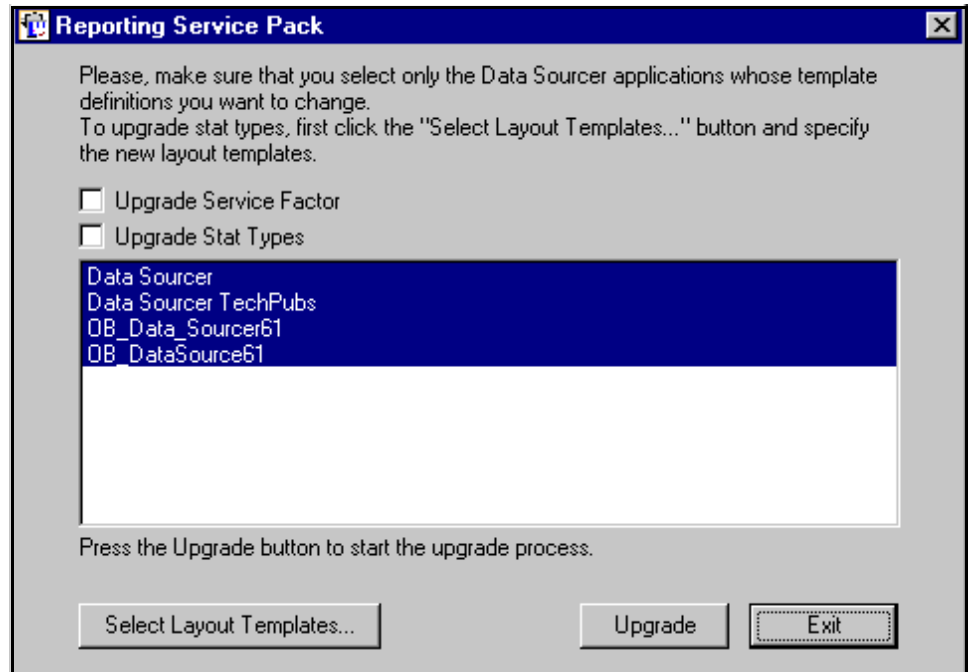

Figure 13: Reporting Service Pack Dialog Box

Note: At any time from this point forward—before clicking **Upgrade**—you can click **Exit** to terminate the utility without upgrading.

5. Mark the appropriate check boxes to upgrade **Service Factor** and/or stat types. (See “**Considerations and Recommendations**” on [page 219](#) to understand the advantages of upgrading each type.)
6. Select the **Data Sourcer** applications you want to upgrade at this time. By default, the utility selects all **Data Sourcer** applications.
7. Right-click applications in this list box to clear or reselect them.

Warning! Double-check all of your selections closely. The upgrade process is irreversible if you did not back up your ODS.

8. If you marked the Upgrade Stat Types check box in Step 3, click Select Layout Templates... button to select the set of 6.5 layout templates from which a new definition should be imported.

Note:

- If you did not mark the Upgrade Stat Types check box in Step 3, proceed to Step 9.
- Layout templates contain the stat type definitions that are applied to the Stat Server assigned to Data Sourcer. These templates are provided in XML format on your solution DVD.

The utility displays the Select files dialog box shown in Figure 14.

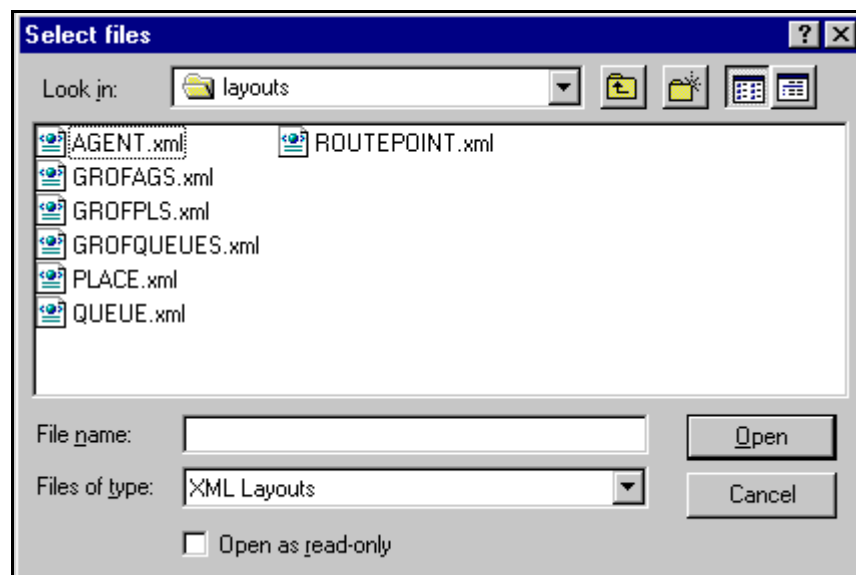

Figure 14: Select Files Dialog Box

9. Select all the 6.5 XML files you want to use for Stat Type definition source, then click OK. To select more than one file, hold down the Control key while selecting other files. Click Open when done.

Note: The utility returns you to the Reporting Service Pack dialog box pictured in Figure 13 on page 230.

10. On the Reporting Service Pack dialog box, click Upgrade to start the upgrade process.

The utility silently upgrades one Data Sourcer at a time and displays a final closing message if everything was upgraded successfully (see Figure 15).

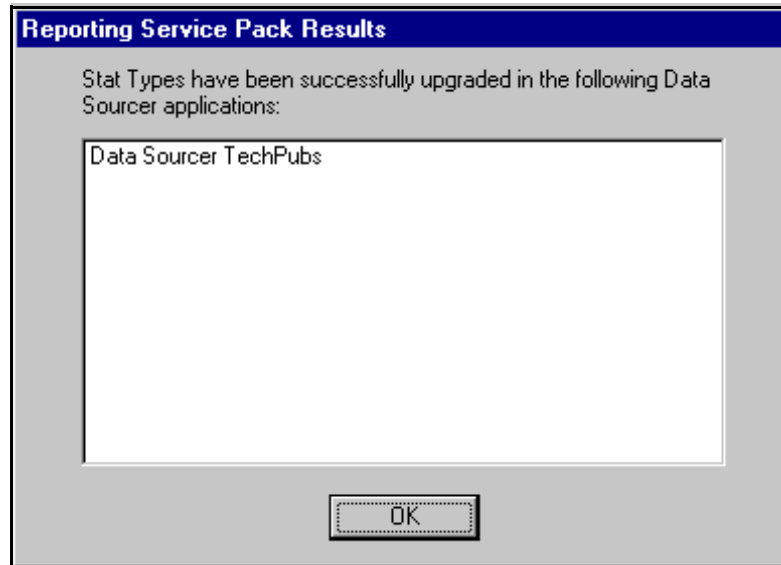

Figure 15: A Successful Upgrade Message

11. Click **OK**. If, however, the utility encountered errors, it prompts you for further action (see [Figure 16](#)).

Note: After the selected Data Sourcer applications have been upgraded, they will disappear from the list of available Data Sourcers in [Figure 7](#). If you want to upgrade definitions that you had not previously indicated in these Data Sourcer applications, you must first exit the utility then restart it.

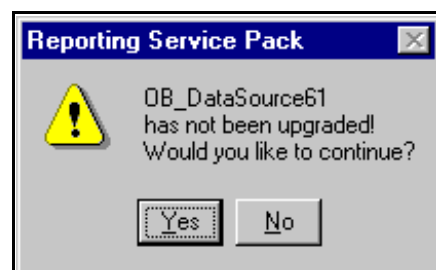

Figure 16: An Unsuccessful Upgrade Message

This message can differ depending on the error encountered. Take the appropriate action.

12. Click **Exit** to close the utility.

Should you encounter problems, recheck that the requisite conditions have been met before contacting Genesys Technical Support. For instance, if you get the following error message:

Cannot Start DBClient of type <RDBMS type>

the DB Server for Data Sourcer's ODS is probably not running. And, if you get this message:

Category TotalAdjustedNumber can't be found in ODS

then your Data Sourcer version is probably not 6.1.012 or later as required. Migrate your Reporting environment to 6.1 as documented in the Chapter 15, "Reporting Migration Procedures," on [page 211](#).

Restoring from Backup

If, for some reason, the upgrade was unsuccessful or if you want to return to the definitions in your previous Reporting environment, do the following:

To Return to Previous Definitions

1. Exit the Reporting Service Pack utility.
2. Restore your ODS from backup.
3. Open a document window in DMA for a Data Sourcer application you changed.
4. Click **Synchronize** on the toolbar to restore Stat Server stat type definitions for that Data Sourcer.
5. Repeat these steps for each Data Sourcer application you changed using the Reporting Service Pack.

Contact Genesys Technical Support for assistance or for technical difficulties.

Stat Type Listing

This section lists the stat types found in the solution-provided layout templates. Several of the stat types are used in more than one layout template; so, when you select a particular layout template for upgrade, understand that stat types shared with other templates are upgraded as well—even if you did not explicitly select the other layout template for upgrade.

With the exception of `N_DISTRIB_IN_TR` metric, the stat type assignments to metrics in layout templates across the Genesys releases have not changed. The `CampCancel` stat type, for example, was originally introduced in 6.0 and was assigned to the `N_CANCEL` metric in the `CALL_LS`, `CMP`, and `CMP_CALL_L` layout templates. In the 6.5 release of these layout templates, the same is true. The `N_DISTRIB_IN_TR` metric is used in the `QUEUE`, `ROUTEPOINT`, and `GROFQUEUES` layout templates.

Those stat types in Table 32 on [page 234](#) marked with an asterisk are also used by CC Pulse. If CC Pulse uses the same Stat Server as CC Analyzer, then you will notice changes in CC Pulse reports too.

Table 32: List of Stat Types by Layout Template for Release 6.5

Layout Template	AGENT	CALL_LS	CC_AG	CC_GRAG	CC_GRQ	CC_Q	CC_RP	CMP	CMP_CALL_L	CMP_GR	GROFAGS	GROPLS	GROFQUEUES	O_AGENT	O_AGENT_GR	PLACE	QUEUE	ROUTEPOINT
CampAbandoned*		✓						✓	✓									
CampAnsweringMachine*		✓						✓	✓									
CampAnswers*		✓						✓	✓									
CampBusy*		✓						✓	✓									
CampCallbacksCompleted*		✓						✓	✓									
CampCallbacksMissed*		✓						✓	✓									
CampCallbacksScheduled*		✓						✓	✓									
CampCancel*		✓						✓	✓									
CampDialMade*		✓						✓	✓									
CampDoNotCall*		✓						✓	✓									
CampDropped*		✓						✓	✓									
CampFaxModem*		✓						✓	✓									
CampGrActivatedDuration*										✓								
CampGrDeactivatedDuration*										✓								
CampGrRunningDuration*										✓								
CampGrSystemErrorDuration*										✓								
CampGrWaitingAgentsDuration*										✓								
CampGrWaitingPortDuration*										✓								
CampGrWaitingRecordsDuration*										✓								
CampNoAnswer*		✓						✓	✓									
CampNoRPC*		✓						✓	✓									
CampPersonalCallbacksCompleted*		✓						✓	✓									
CampPersonalCallbacksMissed*		✓						✓	✓									
CampPersonalCallbacksScheduled*		✓						✓	✓									
CampRecordsCompleted*		✓						✓	✓									
CampSITDetected*		✓						✓	✓									
CampSITInvalidNum*								✓										
CampSITNoCircuit*		✓						✓	✓									
CampSITOperIntercept*		✓						✓	✓									
CampSITReorder*		✓						✓	✓									
CampSITUnknown*		✓						✓	✓									

Table 32: List of Stat Types by Layout Template for Release 6.5 (Continued)

Layout Template	AGENT	CALL_LS	CC_AG	CC_GRAG	CC_GRQ	CC_Q	CC_RP	CMP	CMP_CALL_L	CMP_GR	GROFAGS	GROPLS	GROFQUEUES	O_AGENT	O_AGENT_GR	PLACE	QUEUE	ROUTEPOINT
CampSITVacant*		✓						✓	✓									
Max_Time_to_Abandon					✓	✓	✓						✓				✓	✓
Max_Time_to_Answer													✓				✓	✓
Max_Time_to_Distribute					✓	✓	✓											
Total_ASM_Engage_Time														✓				
Total_Calls*	✓		✓	✓							✓	✓		✓	✓	✓		
Total_Calls_Abandoned*					✓	✓	✓						✓				✓	✓
Total_Calls_Answered					✓	✓	✓						✓				✓	✓
Total_Calls_Answered_In_Threshold					✓	✓	✓						✓				✓	✓
Total_Calls_ASM_Outbound*														✓	✓			
Total_Calls_ASM_Received*														✓	✓			
Total_Calls_Consult*	✓		✓	✓							✓	✓		✓	✓	✓		
Total_Calls_Dialed			✓	✓														
Total_Calls_Distributed*					✓	✓	✓						✓				✓	✓
Total_Calls_Entered					✓	✓	✓						✓				✓	✓
Total_Calls_Inbound*	✓		✓	✓							✓	✓		✓	✓	✓		
Total_Calls_Internal*	✓		✓	✓							✓	✓		✓	✓	✓		
Total_Calls_Outbound*	✓		✓	✓							✓	✓		✓	✓	✓		
Total_Calls_Unknown	✓		✓	✓							✓	✓		✓	✓	✓		
Total_Consult_Talk_Time	✓										✓	✓		✓	✓	✓		
Total_Dialing_Number	✓										✓	✓		✓	✓	✓		
Total_Dialing_Time	✓		✓	✓							✓	✓		✓	✓	✓		
Total_Hold_Time	✓		✓	✓							✓	✓		✓	✓	✓		
Total_Login_Time*	✓		✓	✓							✓	✓		✓	✓	✓		
Total_Not_Ready_Number	✓		✓	✓							✓	✓		✓	✓	✓		
Total_Not_Ready_Time*	✓		✓	✓							✓	✓		✓	✓	✓		
Total_Number_of_Conferences	✓		✓	✓							✓	✓		✓	✓	✓		
Total_Number_of_Transfers_Made	✓		✓	✓							✓	✓		✓	✓	✓		
Total_Number_of_Transfers_Taken	✓		✓	✓							✓	✓		✓	✓	✓		
Total_Number_on_Hold	✓		✓	✓							✓	✓		✓	✓	✓		
Total_Ringing_Number	✓		✓	✓							✓	✓		✓	✓	✓		
Total_Ringing_Time	✓		✓	✓							✓	✓		✓	✓	✓		

Table 32: List of Stat Types by Layout Template for Release 6.5 (Continued)

Layout Template	AGENT	CALL_LS	CC_AG	CC_GRAG	CC_GRQ	CC_Q	CC_RP	CMP	CMP_CALL_L	CMP_GR	GROFAGS	GROPLS	GROFQUEUES	O_AGENT	O_AGENT_GR	PLACE	QUEUE	ROUTEPOINT
Total_Short_Abandoned_Calls					✓	✓	✓						✓				✓	✓
Total_Talk_Time*	✓		✓	✓							✓	✓		✓	✓	✓		
Total_Talk_Time_ASM_Outbound														✓	✓			
Total_Talk_Time_Inbound	✓		✓	✓							✓	✓		✓	✓	✓		
Total_Talk_Time_Internal	✓		✓	✓							✓	✓		✓	✓	✓		
Total_Talk_Time_Outbound	✓		✓	✓							✓	✓		✓	✓	✓		
Total_Talk_Time_Unknown	✓		✓	✓							✓	✓		✓	✓	✓		
Total_Time_ASM_Engage															✓			
Total_Time_to_Abandon					✓	✓	✓						✓				✓	✓
Total_Time_to_Answer													✓				✓	✓
Total_Time_to_Distribute					✓	✓	✓						✓				✓	✓
Total_Wait_Number	✓		✓	✓							✓	✓		✓	✓	✓		
Total_Wait_Time	✓		✓	✓							✓	✓		✓	✓	✓		
Total_Work_Number	✓		✓	✓							✓	✓		✓	✓	✓		
Total_Work_Time*	✓		✓	✓							✓	✓		✓	✓	✓		



Part

4

Outbound Contact Migration

The chapters in this section describe the migration paths to Outbound Contact 8.0 and present step-by-step procedures for migrating from previous releases to release 8.0. The chapters also discuss component changes and the other Genesys software that supports and enables Outbound functionality.

The information is divided into the following chapters:

- [Chapter 17, “Introduction to Outbound Contact Migration,” on page 239](#) discusses the preliminary migration procedures and the migration order for Outbound Contact 8.0.
- [Chapter 18, “Changes in Outbound Contact,” on page 247](#) provides information that you need to upgrade components, configuration options, fields, Calling Lists and their formats in Outbound Contact from release 6.5.x to release 8.0.
- [Chapter 19, “Outbound Contact Migration Procedures,” on page 277](#) presents the procedures for migrating to Outbound Contact 8.0.



Chapter

17

Introduction to Outbound Contact Migration

This chapter discusses the preliminary migration procedures and the migration order for Outbound Contact 8.x.

There are three main sections in this chapter:

- [Interoperability Among Outbound Contact Components, page 239](#)
- [Preliminary Migration Procedures, page 242](#)
- [Order of Migration, page 243](#)

Interoperability Among Outbound Contact Components

The term *interoperable* means that different versions of Genesys solutions, components, or options can work together compatibly during the migration process.

Two Levels of Interoperability

Interoperability of Genesys products can occur at two levels of migration:

- **Interoperability at the suite level** means combining different versions of solutions and options during the migration process. See the *Genesys 8 Interoperability Guide* for information about the compatibility of Genesys products with various Configuration Layer Environments; Interoperability of Reporting Templates and Solutions; and *Gplus* Adapters Interoperability.

- **Interoperability at the solution-specific level** means combining different versions of the components of a particular solution while upgrading them sequentially during the migration process. As you upgrade each of the components in sequence, you need to know if it is backward-compatible with the other components of the Outbound Contact.

Migration Paths

The following are the migration paths for different releases of Outbound Contact:

- If you are using Outbound Contact Server (OCS) 7.6 and are migrating to 8.0, follow the procedures on [page 277](#).
- If you are using OCS 7.5 and are migrating to 7.6, follow the procedures on [page 280](#).
- If you are using OCS 7.2 and are migrating to 7.5, follow the procedures on [page 282](#). When migrating to Outbound Contact 7.5, you must upgrade to Framework 7.5 first.
- If you are using OCS 7.1 and are migrating to 7.2, follow the procedures on [page 286](#).
- If you are using OCS 6.5.2 and are migrating to 7.2, follow the procedures on [page 290](#).
- If you are using OCS 6.5.100.27–6.5.100.30 and are migrating to 7.2, follow the procedures on [page 292](#).

Note: If you are using Outbound Contact Server 6.5.200.05 or a previous version, you must upgrade OCS first, then upgrade Framework to 7.2.

- If you are using OCS 6.5.xxx —6.5.100.26 and are migrating to 7.2, follow the procedures on [page 295](#).
- If you are using OCS 5.1.5, 6.0, or 6.1, follow this two-step migration path:
 - For OCS versions 5.1.5, 6.0, or 6.1 to OCS 6.5.2, see the *Genesys 6.5 Migration Guide*.
 - For OCS versions 6.5.2 to 7.1, see “Migration from 6.5.2 to 7.2” on [page 290](#).

Note: If you are upgrading OCS to 7.2 and are also using CPD Server, then you must also upgrade CPD Server to 7.2 and vice versa. CPD Server must be of the same release as OCS. You cannot perform a partial upgrade of these Outbound Contact components.

Compatibility Among Components of Outbound Contact

Outbound Contact 8.0 is compatible with Framework 7.5, 7.6, and 8.0.

Note: In Outbound Contact 8.0, Genesys Administrator 8.0 replaces Outbound Contact Manager for provisioning, monitoring, and deploying Outbound Contact, and Campaign Group operations (such as start, stop, load, unload, and so on). However, OCM 7.6 can still be used.

The following lists compatibilities between releases of Outbound Contact prior to release 8.0:

- Outbound Contact 7.6 is compatible with Framework 7.5 and 7.6.
- Outbound Contact 7.5 (which includes OCS, and OCM and may include CPD Server and CPD Proxy Server), requires Framework 7.5. It is not compatible with previous releases of Framework.
- OCS 7.2 operates with these versions of the other components of Outbound Contact:
 - OCM 7.1, 7.0, 6.5.2, and 6.5.1
 - CPD Server 7.2
- Outbound Contact Manager 7.1 operates with these versions 7.0, 6.5.2, and 6.5.1 of Outbound Contact Server.

Note: There is no direct interaction between OCM and CPD Server, so interoperability is not an issue between these two components of Outbound Contact.

- CPD Server 7.2 operates with OCS 7.2. CPD Server 7.2 is not compatible with earlier versions of OCS.

Note: If you are using a Meridian switch and CPD Server is configured with a DN type `position` for the channel setup, then the DN configuration must be changed to `Extension`. In the 7.2 release, `Position` is not a valid value for a CPD Server DN type. For more information, see the *Outbound Contact 7.2 Deployment Guide*.

- CPD Proxy Server 7.2 operates with multiple CPD Servers 7.2.

Additional Information About Migration

This additional information will assist you with your migration.

Multi-Site/ Single-Site and Multi-Tenant Migration

Common interoperability rules apply for Outbound components. If the components are compatible, there is no difference between single-site and multi-site configuration. It is possible to migrate all sites or all tenants simultaneously. It is also possible to migrate separate sites independently.

Note: When migrating to Outbound Contact 7.5, you must upgrade to Framework 7.5 first.

Other Migration Issues

- CPD Server supports only the Dialogic drivers (for [System Release 6](#)) that are provided on the CPD Server DVD.

Note: For an overview of other migration issues, please see Chapter 1, “Migration Roadmap,” on [page 35](#).

Preliminary Migration Procedures

Complete the following these procedures before migrating to Outbound Contact 8.0:

Database and Operating System Upgrades

Note: If you want to upgrade your operating system before migrating your Genesys product, contact Professional Services.

Before migration, you might need to upgrade the operating system and/or database used by Outbound Contact 8.0. To determine whether you must perform these upgrades:

1. Go to the Genesys Technical Support website.
2. Click the Knowledge Base link.
3. Click the Release Information link.
4. Click the General link.
5. Click the Genesys Supported Operating Systems and Databases link.

If you need to upgrade your operating system and/or database, consult your vendor documentation. If you need help to perform upgrades, contact Genesys Professional Services.

Preliminary Migration Procedures

The migration process includes these preliminary procedures for Outbound Contact 8.0:

1. Review Chapter 1, “Migration Roadmap,” on [page 35](#) of this guide.
2. Examine the order in which to upgrade the Genesys software required for Outbound Contact 8.0. See “Order of Migration” on [page 243](#).
3. Review these changes:
 - “Changes in Outbound Contact Components” on [page 248](#).
 - “Changes in Configuration Options” on [page 254](#).
 - “Changes in Reserved User Data Keys” on [page 271](#).
 - “Changes in Fields and Field Values” on [page 272](#).
 - “Changes in Calling Lists and Formats” on [page 274](#).
 - “Changes in Licensing” on [page 274](#).

Note: These sections discuss only changes that directly affect the migration of this product. For complete information about changes in Outbound Contact 8.0, see the *Outbound Contact 8.0 Deployment Guide*

To review other issues pertaining to the migration of Outbound Contact from release 6.5.x to 8.0, see “Additional Information About Migration” on [page 242](#).

Order of Migration

This section provides general steps about migrating Outbound Contact solution. For more information, see “Migration to 8.0” on [page 277](#).

Migration and Upgrade Order

Migrate or upgrade the applications in Outbound Contact and other relevant data in the following order:

1. Install Licensing Manager.

Refer to these documents for information about licensing requirements and for instructions on installing the license(s):

 - *Genesys Licensing Guide*:
 - *Outbound Contact 8.0 Deployment Guide*

2. Migrate Management Framework.

Management Framework is the foundation for all Genesys products, solutions, and options. Run the Configuration Conversion Wizard (CCW) to migrate the configuration database before the Configuration Layer migration.

Note: The Outbound Solution Wizard is also known as the Outbound Contact Configuration Wizard.

Genesys recommends that you use Genesys Administrator instead of the Outbound Contact Configuration Wizard for configuring your enterprise, because much of the wizard functionality is integrated into Genesys Administrator.

This Wizard was not updated for release 8.0. The Outbound Contact Configuration Wizard 7.5 is included in the Outbound Contact 8.0 package.

For more information about migrating the layers and components of Management Framework, see the “Framework Migration” section in this guide. The following information lists abilities and restrictions before migrating:

- You can migrate to the 8.0 Configuration Layer while still using 7.6 Outbound components.
- You can migrate to the 7.6 Configuration Layer while still using 7.5 Outbound components.
- You must migrate to the 7.5 Configuration Layer before installing the 7.5 Outbound components.
- You can migrate to the 7.2 Configuration Layer while still using 6.5.2 Outbound components.
- You can also migrate to the 7.2 Configuration Layer while still using OCS 6.5.200.05 and later releases.

3. Migrate data.

CCW can be used to migrate the necessary objects in Configuration Manager and Genesys Administrator. Calling Lists and Do Not Call Lists that were used in release 7.2, 7.5, and 7.6 can be used in release 8.0. For Calling Lists and the Do Not Call list that were used before release 7.2, see “Migration from 7.1 to 7.2” on [page 286](#).

4. Upgrade Agent Desktop.

The Agent Desktop is not a component of Outbound Contact. However, it uses the OCS-Desktop protocol, which evolves from one release of Outbound Contact to the next. Refer to the Agent Desktop documentation for information about upgrading this application.

5. Upgrade other dependent Genesys components.

When upgrading many components, determine if the component you upgrade is backward compatible with older components that have not been upgraded yet. See “Interoperability Among Outbound Contact Components” on [page 239](#) of this guide.

6. Install and configure Genesys Administrator. For information, see the *Framework 8.0 Genesys Administrator Deployment Guide*.
7. Import the Application templates.
 - In Configuration Manager, the Application templates are accessible through:
Configuration > Environment > Applications Templates>
 - In Genesys Administrator, the Application templates are accessible through:
Provisioning > Environment > Applications Templates>

For instructions on importing an Application template, see the *Outbound Contact 8.0 Deployment Guide* or *Framework 8.0 Genesys Administrator Help*.

8. Create and configure the Outbound Contact Application objects.

When you use Genesys Administrator to create an Application template, you have the option to import metadata. If you select this option, when you create the template it will contain application options set with the default values. As a result, all applications that you create using this template will include all of the options set to the default values. Select this option, if you want your applications to contain all configuration options. You can adjust the option values later. For more information about the options, see the “Outbound Contact Configuration Options” chapter in the *Outbound Contact 8.0 Deployment Guide*.
9. If you are creating a new solution rather than upgrading components of the existing solution, import the Solution template for Outbound Contact 8.0.

For information about using a Solution, see the *Outbound Contact 8.0 Deployment Guide*.
10. Reporting templates have not changed since release 7.2. Upgrade your reporting templates if you have not done so. See the Reporting documentation for information about importing Reporting templates.

Note: In release 7.5, the following outbound-specific statistics were added: `CurrentAgentAssignment`, `CurrentNumberAgentsAssigned`, and `CurrentCampaignGroupDBID`.

In release 7.6, the following outbound-specific statistics were added: `CurrentTrustFactor` and `CurrentFeedbackAccuracy`.

For more information about these statistics, see the “Outbound-Specific Statistics for Stat Server” section in Chapter 5 of the *Outbound Contact 8.0 Deployment Guide*.



Chapter

18

Changes in Outbound Contact

This chapter provides information to upgrade components, configuration options, data keys, fields, formats, calling lists in Outbound Contact from the 6.5 releases to the 8.0 release. For a comprehensive list of changes from release to release, see the *Outbound Contact 8.0 Deployment Guide*.

This chapter includes the following sections:

- [Changes in Outbound Contact Components, page 248](#)
- [Changes in Configuration Options, page 254](#)
- [Changes in the Primary Key, page 270](#)
- [Changes in Reserved User Data Keys, page 271](#)
- [Changes in Fields and Field Values, page 272](#)
- [Changes in Calling Lists and Formats, page 274](#)
- [Changes in Licensing, page 274](#)

-
- Notes:**
- When migrating to Outbound Contact 8.0, you can upgrade to Framework 8.0 first, but it is not necessary, because Outbound Contact 8.0 is compatible with Framework 7.6. However, if you choose to use an older version of Framework, some new features (for example, Roles, implemented in Framework 8.0) will not be available to you.
 - You must upgrade to Outbound Contact 7.2 before you can migrate to release 7.5 or higher. When doing so, migrate Framework first before migrating Outbound Contact.
 - You must first migrate to release 6.5 if you are migrating to release 7.2 from release 5.1.5, 6.0, or 6.1. Please refer to the *Genesys 6.5 Migration Guide* for more information.
-

Changes in Outbound Contact Components

[Table 33](#) lists the high-level component changes in Outbound Contact. For more detailed information, see the *Outbound Contact 8.0 Deployment Guide*.

Table 33: Component Changes

Current Component Name	Type of change	Change Occurred in Version #	Details (optional)
Release 8.0			
Outbound Contact Server	Support for outbound campaigns in a pure VoIP environment	8.0	Enables automated outbound dialing in a VoIP environment. This feature leverages the capabilities of SIP Server, GVP Media Control Platform (MCP), and Resource Manager. It also includes a new Progressive GVP dialing mode.
Outbound Contact Server	Support for HTTP protocol to communicate with clients using HTTP requests and responses	8.0	Enables clients like GVP to send requests over HTTP protocol.
Outbound Contact Server	SCXML-based Treatments	8.0	Allows you to create customer-focused treatments written in SCXML (State Chart Extensible Markup Language), providing greater flexibility on how to contact customers and handle call results.
Outbound Contact Server	Time-optimized predictive algorithm	8.0	Provides contact centers with the flexibility to adjust the dialing pace for a specific period. The main benefit of this new algorithm is that it allows you to increase the Busy Factor but still keep the overdial rate (ODR) within legislative limits.

Table 33: Component Changes (Continued)

Current Component Name	Type of change	Change Occurred in Version #	Details (optional)
Outbound Contact Server	Instant messaging	8.0	Supports processing the Instant Messaging phone type.
Outbound Contact Server	Support for Genesys Administrator	8.0	<p>A new customer interface provides the capability to provision, monitor, and deploy Outbound Contact 8.0 and other Genesys solutions. Using Genesys Administrator 8.0.2, you can also administer campaigns and campaign sequences.</p> <p>Note: This interface replaces Outbound Contact Manager (OCM). However, you can still use OCM 7.6 with Outbound Contact 8.0.</p>
Outbound Contact Server, CPD Server, and CPD Server Proxy	Agent assignment in multiple Campaigns in ASM modes	8.0	Enables agents to be assigned dynamically to multiple campaigns in ASM modes, increasing efficiency by leveraging agents with their associated skills.
Outbound Contact Server	Support for the ESP protocol in autodialing modes	8.0	Supports operations on calling records for third-party clients (for example, Interaction Server) over a dedicated ESP port in all dialing modes.
Outbound Contact Server	Optional prevention of canceling records on desktops	8.0	A new cancel-on-desktop option prevents OCS from canceling records that are already on an agent's desktop. This allows the agent to complete calls and their associated records that are still in progress, rather than locking the records and preventing their completion.

Table 33: Component Changes (Continued)

Current Component Name	Type of change	Change Occurred in Version #	Details (optional)
Outbound Contact Server	Ability to select the first (preferred) record for dialing	8.0	A new treatment-preferred-contact-field option allows you to define the field name in the Calling List table that OCS uses for the given record to determine if this record in a chain should be used for the first chain dial attempt.
Outbound Contact Server	Recall interactions in Push Preview dialing mode	8.0	OCS can recall all interactions that have not yet begun processing when a Dialing Session for a Campaign is unloaded. This prevents the corresponding records from being updated as State and significantly shortens the unloading time of the session.
Release 7.6			
Outbound Contact Server	New agent desktop notification, ReadyTime, added to the Outbound Desktop protocol	7.6.1	<p>To increase campaign performance in the Predictive/Predictive with seizing dialing modes for small groups, desktop sends the ReadyTime event to OCS, providing the estimated time remaining (in seconds) until the agent will become Ready.</p> <p>OCS replies with either ReadyTimeAcknowledgement or ReadyTimeError.</p> <p>For more information, see the <i>Outbound Contact 7.6 Reference Manual</i>.</p>

Table 33: Component Changes (Continued)

Current Component Name	Type of change	Change Occurred in Version #	Details (optional)
Outbound Contact Server	New real-time outbound-specific statistics	7.6.1	Two outbound-specific statistics were added in the 7.6.1 release: <code>CurrentTrustFactor</code> and <code>CurrentFeedbackAccuracy</code> . Both statistics are reported to Stat Server via the Outbound Contact Java extension. For more information, see the <i>Outbound Contact 7.6 Deployment Guide</i> .
CPD Server	HMP Service Update (SU) driver compatibility change	7.6.1	CPD Server 7.6.1 is compatible with HMP SU 174 and higher.
Outbound Contact Server	<code>CampaignStopped</code> event	7.6	OCS no longer supplies the <code>GSW_CAMPAIGN_MODE</code> attribute in the <code>CampaignStopped</code> desktop notification.
Outbound Contact Server	<code>CampaignStatusRequest</code>	7.6	OCS responds to this <code>CampaignStatusRequest</code> with the same message that is delivered to the agent's desktop upon the agent's login, if the agent is identified as a participant in the active/running campaign group.
CPD Server	HMP SU driver compatibility change	7.6	CPD Server 7.6.0 is compatible with HMP SU drivers up to and including version 150.
Release 7.5			
Outbound Contact Server	Multi-campaign agent assignment	7.5	Enables agents to participate in several campaigns at once.

Table 33: Component Changes (Continued)

Current Component Name	Type of change	Change Occurred in Version #	Details (optional)
Outbound Contact Server	Genesys Voice Platform (GVP) integration	7.5	Reduce resource costs through the use of automated agents to proactively contact customers who do not require a live agent for caller interactions.
Outbound Contact Server	Customer Information Management (CIM) support	7.5	<ul style="list-style-type: none"> • Extends outbound calling list and campaign management to multimedia channels. • Improves agent efficiency by matching the customer with the appropriate agent. • Enables prioritization of outbound interactions with other interaction types for blending purposes.
CPD Server	Support for Dialogic Host Media Processing (HMP) software	7.5	CPD Server now supports HMP software.
Release 7.2			
CPD Server	Support for only Dialogic System Release 6	7.2	CPD Server supports only the Dialogic drivers (for Service Release 6) that are provided on the CPD Server DVD.
CPD Server	Support for DM/V boards	7.2	Support both in transfer mode with line-side protocols and in ASM mode with ISDN.
Release 7.0			
CPD Server	Additional protocol support	7.0	Support for Melcas Protocol in ASM mode on DM3 hardware.

Table 33: Component Changes (Continued)

Current Component Name	Type of change	Change Occurred in Version #	Details (optional)
CPD Server	Support for DM3 boards	7.0	<p>Support for these DM3 families of boards with CPA functionality in ASM mode (Melcas only):</p> <p>DM/V1200-4E1 (number of ports = 120)</p> <p>DM/V600-2E1 (number of ports = 60)</p> <p>DM/V960-4T1 (number of ports = 96)</p> <p>DM/V480-2T1 (number of ports = 48)</p>
CPD Proxy Server	New component	7.0	<p>A new CPD Proxy Server, which connects multiple servers, supports call load distribution. The Proxy Server distributes calls among several CPD Servers when the number of CPD Ports required to service a big Agent Group exceeds the number of ports that a single CPD Server can support. The call load distribution is configurable.</p>

Changes in Configuration Options

Table 34 explains the changes to configuration options for the components in Outbound Contact. For more detailed information, see the *Outbound Contact 8.0 Deployment Guide*.

- Notes:**
- Outbound Contact 7.5 and higher now use the dash character (-) in new option names. Previously, option names could contain the underscore character (_).
 - In release 7.5 (and propagated to all higher releases), all Campaign-Level and Agent or Place Group-Level options were moved to other levels. Some were moved to Campaign Group-Level. See the *Outbound Contact 7.5 Deployment Guide* for details.

Table 34: Configuration Option Changes

Component Name	Option/Section Name	Type of Change	Change Occurred in Version	Details (optional)
Release 8.0				
OCS	am-beep-detection	New option	8.0	Specifies whether GVP is forced to detect an answering machine beep tone before playing music or starting the VXML application in Outbound VoIP dialing modes.
OCS	asm_drop_announcement_data	Updated	8.0	Existing option updated so that it can be used in a VoIP environment.
OCS	asm_drop_am_announcement_data	Updated	8.0	Existing option updated so that it can be used in a VoIP environment.

Table 34: Configuration Option Changes (Continued)

Component Name	Option/Section Name	Type of Change	Change Occurred in Version	Details (optional)
OCS	beep-on-merge	New option	8.0	Enables the playing of a beep tone to the agent on the engaging call immediately before the agent is bridged to the customer call when running in Outbound VoIP dialing modes.
OCS	call_answer_type_recognition	Updated	8.0	Existing option updated so that it can be used in an Outbound VoIP environment.
OCS	call_transfer_type	Updated	8.0	Existing option updated so that it can be used in an Outbound VoIP environment.
OCS	call_wait_in_queue	Updated	8.0	Existing option updated so that it can be used in an Outbound VoIP environment.
OCS	cancel-on-desktop	New option	8.0	Specifies how OCS behaves when it receives a RequestRecordCancel request but finds records on an agent's desktop that have the specified phone or the customer ID.
OCS	cpd-on-connect	New option	8.0	Specifies when call progress analysis is started in Outbound VoIP dialing modes.
OCS	cpd-recording	New option	8.0	Enables or disables the recording of the call progress detection phase of the call for VoIP dialing modes.

Table 34: Configuration Option Changes (Continued)

Component Name	Option/Section Name	Type of Change	Change Occurred in Version	Details (optional)
OCS	customer_id	Updated	8.0	Can be used now to identify customers by their ID for record cancellation.
OCS	merge-method	New option	8.0	Defines the OCS merge method for outbound and engaging calls in the Outbound VoIP ASM dialing modes.
OCS	non-bridging-unable	New option	8.0	Defines OCS's behavior when there is no established engaging call on the same MCP/Media Server and it is not possible to use the bridging method.
OCS	pa-odr-interval	New option	8.0	Specifies the time interval, in minutes, that OCS uses to match the target value of the Overdial Rate.
OCS	predictive_algorithm	New value, time_optimized_odr	8.0	New value associated with the time-optimized predictive algorithm. When using this value, OCS monitors the predictive_max_overdial_rate. If it is greater than zero but less than the current overdial rate, OCS switches from the Predictive to the Progressive dialing mode.
OCS	treatment-holidays-table	New option	8.0	(For SCXML Treatments) Defines the name of the Statistical Table configuration object that OCS uses to determine the dates and time ranges for holidays.

Table 34: Configuration Option Changes (Continued)

Component Name	Option/Section Name	Type of Change	Change Occurred in Version	Details (optional)
OCS	treatment-preferred-contact-field	New option	8.0	Defines the field name in the Calling List table that OCS uses for the given record to determine if this record in a chain should be used for the first chain dial attempt.
OCS	treatment-uri	New option	8.0	(For SCXML Treatments) Defines the URI to the SCXML treatment script resource.
OCS	treatment-weekdays-table	New option	8.0	(For SCXML Treatments) Defines the name of the statistical table configuration object that OCS uses to determine the time ranges for business weekdays.
Release 7.6				
OCS	outbound_answer_action	New value, hard_acw	7.6.1	When set to this value, OCS sends a request to T-Server to force the teleset to the After Call Work state after an outbound call is established on an agent's DN.
OCS	outbound_release_action	New value, hard_acw	7.6.1	When set to this value, OCS sends a request to T-Server to force the teleset to the After Call Work state after an outbound call is released from an agent's DN.

Table 34: Configuration Option Changes (Continued)

Component Name	Option/Section Name	Type of Change	Change Occurred in Version	Details (optional)
OCS	asm_drop_am _announcement_data	New option	7.6.1	(For ASM modes only) Specifies the message to be played if an answering machine is detected before releasing the established customer call in the ASM modes.
OCS	pa-inbound-ignore	New option	7.6.1	Specifies which method OCS uses to handle the sampled value of inbound traffic in dialing pace calculations. This enables users to specify how to handle dialing-pace calculations for outbound and engaging calls in the Progressive with seizing and the Predictive with seizing dialing modes with respect to inbound traffic.
OCS	pa-selfcheck-awt -threshold	New option	7.6.1	Specifies the percentage of the target Average Waiting Time that the predictive algorithm (PA) uses as the threshold to report a dialing performance degradation.
OCS	pa-selfcheck-bf -threshold	New option	7.6.1	Specifies the percentage of the target Busy Factor that the PA uses as the threshold to report a dialing performance degradation.
OCS	pa-selfcheck-odr -threshold	New option	7.6.1	Specifies the percentage of the target Overdial Rate that the PA uses as the threshold to report a dialing performance degradation.

Table 34: Configuration Option Changes (Continued)

Component Name	Option/Section Name	Type of Change	Change Occurred in Version	Details (optional)
OCS	pa-selfcheck-interval	New option	7.6.1	Specifies the time interval, in minutes, that the PA uses to calculate the current values of the optimization parameters and to track any suspicious condition for reporting dialing performance degradation.
OCS	outbound_agent_outlier_limit	Affected by predictive-longcalls-truncation option	7.6.1	If configured, the predictive-longcalls-truncation option takes precedence over this option and the outbound_agent_outlier_limit option is not taken into account by OCS.
OCS	predictive_algorithm	New value	7.6.1	The new value of advanced_small_group was added to increase the performance of campaigns in the Predictive and Predictive with seizing modes for small agent groups; Campaign Group-Level object or Application level
OCS	predictive-longcalls-truncation	New option	7.6.1	Enhances the performance in the Predictive and Predictive with seizing modes by not taking into account calls which are significantly longer statistically than the rest of the calls.
OCS	small_group_size	Upper limit removed for valid values	7.6.1	This option has no maximum value now.

Table 34: Configuration Option Changes (Continued)

Component Name	Option/Section Name	Type of Change	Change Occurred in Version	Details (optional)
OCS	time-to-ready-tolerance	New option	7.6.1	Specifies the allowed variance on time estimates when an agent will become Ready .
OCS	user_data_section_name	Functionality increased	7.6	Supports adding customer user data for the Campaign configuration object by explicitly identifying the type of data to be attached.
OCS	dialing_rate_limit	Existing option added to the switch level	7.6	Specifies the maximum number of calls per second shared among all sessions running in auto-dialing modes that are used by the switch.
OCM	inactivity-timeout	New option	7.6	Specifies the amount of time (in minutes) that Outbound Contact Manager waits for activity before disabling a logged-in user who is not interacting with the application.
CPD Server	audio-codecs	New option	7.6	Defines the codec(s) to use for HMP.
Release 7.5				
OCS	agent-assignment	New option	7.5	Determines agent reassignment to campaigns.
OCS	agent-assignment-priority	New option	7.5	Defines the priority of the Campaign Group when determining agent reassignment.
OCS	agent-assignment-min-num	New option	7.5	Defines the minimum number of agents in the Campaign Group when determining agent reassignment.

Table 34: Configuration Option Changes (Continued)

Component Name	Option/Section Name	Type of Change	Change Occurred in Version	Details (optional)
OCS	agent-assignment-max-num	New option	7.5	Defines the maximum number of agents in the Campaign Group when determining agent reassignment.
OCS	am-detection-map	New option	7.5	Specifies the name of the Business Attribute value configuration object used for CPD based on record type.
OCS	call_wait_connected_timeout	Changed value	7.5	Maximum value is increased to 7200 seconds.
OCS	dialer-ttl	New option	7.5	Specifies Time To Live (in minutes) for the dialing request.
OCS	dialer-num-attempts	New option	7.5	Specifies the number of attempts for the dialing request.
OCS	direct-personal-callback	New option	7.5	Controls the way how records of type “personal callback” are processed.
OCS	inbound-agent-assignment-priority	New option	7.5	Defines the priority of inbound call activities. It is used when determining agent reassignment.
OCS	inbound-agent-assignment-min-num	New option	7.5	Defines the minimum amount of agents to perform inbound call activities.
OCS	inbound_agent_outlier_limit	New option	7.5	Specifies the minimum amount of inbound call time before an agent's status changes to Not Available.

Table 34: Configuration Option Changes (Continued)

Component Name	Option/Section Name	Type of Change	Change Occurred in Version	Details (optional)
OCS	interaction-media-type	New option	7.5	Defines the media type of the interaction submitted to Interaction Server.
OCS	ivr-profile-name	New option	7.5	Specifies the GVP voice application that will handle outbound calls.
OCS	outbound_agent_outlier_limit	New option	7.5	Specifies the minimum amount of outbound call time before an agent's status changes to Not Available.
OCS	pa-dial-expire	New option	7.5	Specifies the timeout (in minutes) that the predictive algorithm uses to clean up calls that are in a Dialed state.
OCS	pa-handle-expire	New option	7.5	Specifies the timeout (in minutes) that the predictive algorithm uses to clean up calls that have reached an agent's desktop.
OCS	pa-handle-time-consider	New option	7.5	Specifies the maximum call duration for all call types when calculating the average call duration.
CPD Server	sip-proxy	New option	7.5	Defines the SIP Proxy host name or IP address.
OCM	AutoReconnect	New option	7.5	Determines if OCM performs an automatic reconnect procedure to OCS, Configuration Server, and DB Server.
OCS	internal_release_action	Deleted option	7.5	
OCS	engaged_release_action	Deleted option	7.5	

Table 34: Configuration Option Changes (Continued)

Component Name	Option/Section Name	Type of Change	Change Occurred in Version	Details (optional)
OCS	internal_answer_action	Deleted option	7.5	
OCS	desktop_version	Deleted option	7.5	
OCS	extended_record_cancel	Deleted option	7.5	
OCS	login_ignore_queue	Deleted option	7.5	
OCS	login_action	Deleted option	7.5	
OCS	ocs_group	Deleted option	7.5	
OCS	stale_clean_interval	Deleted option	7.5	
OCS	main_timer_interval	Deleted option	7.5	
OCS	hide_private_data	Deleted option	7.5	
OCS	inbound_answer_action	Deleted option	7.5	
OCS	inbound_release_action	Deleted option	7.5	
Release 7.2				
OCS	agent_logout_preview_call_result	New option	7.2	Enables OCS to change the call result for Preview, Personal CallBack, or Campaign CallBack records that are on an agent's desktop after receiving an EventAgentLogout message from Stat Server.
OCS	conversion	New option	7.2	Marks the field which indicates that the answered call was a successful transaction. Only used with ICON/GIM applications.
OCS	icon_attribute	New option	7.2	Defines how the field's value will be stored by ICON.

Table 34: Configuration Option Changes (Continued)

Component Name	Option/Section Name	Type of Change	Change Occurred in Version	Details (optional)
OCS	right_person	New option	7.2	Marks the field which indicates that the answered call was with the proper contact. Only used with ICON/GIM applications.
OCS	small_group_size	New option	7.2	Works for the Overdial Rate optimization parameter only. If the current number of agents is less than or equal to this option's value, OCS uses a small-group predictive algorithm.
OCS	transfer_to_unknown_dn	New option	7.2	Specifies OCS's behavior when an outbound call is transferred to an unknown DN.
OCS	treatment_sched_threshold	New option	7.2	Determines the maximum time difference (in minutes) between the current time and the scheduled time for when a chain remains in OCS memory.
CPD Server	keep-channels-open	New option	7.2	Determines how CPD Server uses Dialogic channels.
CPD Server	use-fax2-as-am	New option	7.2	Controls the way the Fax2 tone is detected by enabling CPD Server to detect an Answering Machine by using the Fax2 tone.

Table 34: Configuration Option Changes (Continued)

Component Name	Option/Section Name	Type of Change	Change Occurred in Version	Details (optional)
Release 7.0				
OCS	campaign_name_field	New option	7.0	Defines the name of the field in the Calling List table that holds the campaign name.
OCS	check_dnc_list	New option	7.0	Set at the campaign level, this OCS option enables or disables a pre-dial check of all records belonging to a <i>particular</i> campaign against the Do Not Call list.
OCS	check_dnc_callback	New option	7.0	Enables or disables the dialing of three callback record types when the phone number or customer ID in those records is also in the Do Not Call list.
OCS	hide_private_data	New option	7.0	Application-level option that allows OCS to show or hide attached data in the log output.
OCS	public_network_access_code	Option extended to calling-list level and campaign level	7.0	Previously this option was only configured at the switch level or application level. Set at the calling list level, this option overrides the same option on either the campaign level or the switch level.
OCS	num-of-licenses	New option	7.0	OCS uses these two options for license control.
OCS	license-file	New option	7.0	
OCS	call_predictive_record_on_desktop_timeout	Obsolete option	7.0	This campaign-level option is obsolete for OCS 7.0.

Table 34: Configuration Option Changes (Continued)

Component Name	Option/Section Name	Type of Change	Change Occurred in Version	Details (optional)
OCS	call_wait_engage_agent_timeout	Obsolete option	7.0	This campaign-level option is obsolete for OCS 7.0.
OCS	channel_num	Option removed as a CPD Server-level option for OCS 7.0	7.0	This option is removed as a CPD Server-level option for OCS 7.0, but it remains a switch-level option for OCS.
CPD Server	destination-busy-timeout	New option	7.0	Prevents CPD Server from waiting indefinitely for the results of call progress detection on a busy signal. This new option specifies the length of time (in milliseconds) that CPD Server will wait for confirmation of the call result from T-Server (EventDestinationBusy) after a Busy call result from the Dialogic board. When the timeout expires, CPD Server accepts the busy call result as correct.
CPD Server	license-file	New option	7.0	Specifies the license address.
CPD Server	num-occ-port-licenses	New option	7.0	Specifies the number of licenses that CPD checks out initially.
CPD Server	number-userdata-pairs-to-print	Option removed	7.0	Specified the number of pairs in UserData to print.

Table 34: Configuration Option Changes (Continued)

Component Name	Option/Section Name	Type of Change	Change Occurred in Version	Details (optional)
CPD Server	out-of-service-attempts	New option	7.0	CPD Server immediately marks a Dialogic port <code>out-of-service</code> if the server receives a failure message after a predefined number of attempts to connect to that port. This option sets the number of attempts. See also <code>out-of-service-timeout</code> option.
CPD Server	out-of-service-timeout	New option	7.0	Determines how long to wait (in minutes) before using the out-of-service channel again.
CPD Server	use-gc-makecall-blk	Option removed	7.0	This option was specifically for ISDN support on DM3 boards. Currently CPD Server supports only Melcas protocol on DM3 boards, so this option is obsolete.
CPD Server	tsrelease	Option removed	7.0	Previously, the value of this option indicated whether to send a release request to T-Server (<code>tsrelease = yes</code>) or not to send a release request to T-Server (<code>tsrelease = no</code>). CPD Server 7.x queries the DN to find out if any calls remain active.

Table 34: Configuration Option Changes (Continued)

Component Name	Option/Section Name	Type of Change	Change Occurred in Version	Details (optional)
Release 6.5.2				
OCS	call_timeguard_timeout	New option	6.5.2	This option sets a timeout for call progress detection (CPD). A call is transferred to a queue when the timeout expires, regardless of the call result or the completion of CPD. This option only applies when OCS uses CPD Server. Not applicable when OCS uses PBX equipment for CPD. Option set for the OCS Application object or at the Campaign object level.
OCS	customer_id	New option	6.5.2	Prior to 6.5.2, only the phone field was used as the identifier in the Do Not Call (DNC) List. Since 6.5.2, a user-defined field, as specified by the value of the customer_id option in the OCS Application object, can also serve as an identifier for DNC requests.
OCS	extended_record_cancel	New option	6.5.2	From a third-party application, agents who are not participating in a particular Outbound campaign may cancel a record by phone number in a campaign. Setting extended_record_cancel option to yes enables it for a campaign or for the OCS Application object(s) in the configuration database.

Table 34: Configuration Option Changes (Continued)

Component Name	Option/Section Name	Type of Change	Change Occurred in Version	Details (optional)
OCS	log_call_stats	New option	6.5.2	This option creates a separate subsystem for Audit Logging to capture additional statistics on telephony events.
OCS	remote_release_action	New option	6.5.2	Provides choices for ways in which OCS can handle calls with the result of RemoteRelease.
CPD Server	max-number-ports-to-record	New option	6.5.2	<p>CPD Server is able to create two voice files for outbound calls that it dials: File 1 contains the line recording for the CPD stage. File 2 records the conversation between an agent and the called party if the call result is answer (ASM mode only).</p> <p>The max-number-ports-to-record option specifies the maximum number of agent ports on which to record the voice files at the same time.</p> <p>See these options: cpd-file-name-prefix and conversation-file-name-prefix.</p>
CPD Server	cpd-file-name-prefix	New option	6.5.2	The value of this option is a prefix that identifies voice File 1 (Call Result). The default is cpd_.
CPD Server	conversation-file-name-prefix	New option	6.5.2	The value of this option is a prefix that identifies voice File 2 (Conversation). The default is conv_.

Table 34: Configuration Option Changes (Continued)

Component Name	Option/Section Name	Type of Change	Change Occurred in Version	Details (optional)
CPD Server	forth-tone	New option	6.5.2	A beep signal alerts an agent immediately before a customer is connected. This optional beep signal is turned on or off by the forth-tone option.
CPD Server	line-type	Value changed	6.5.2	A new value dm3 for the line-type option replaced the previous value dm3-isdn.
CPD Server	tsclear	New option	6.5.2	This option controls the way a call is released. If tsclear = yes, RequestClearCall is issued to release an active call.

Other Option Changes

From 6.5.2 release and higher, users can define a dialing filter that exceeds the 255-character limit by dividing the long string into several shorter strings. Configuration options with the same name and sequential numbers added to the ends of the option names enable this feature. Genesys Administrator, OCM, and OCS build a dialing filter by concatenating the values of these options. For more information and examples of these configuration options, see the “Defining a Dialing Filter that Exceeds 255 Characters” section in Chapter 8 of the *Outbound Contact 8.0 Deployment Guide*.

Changes in the Primary Key

In the 7.0 release and higher, the primary key of the Calling List database table consists of the chain_id and chain_n fields. The primary key in 6.x consisted of the phone and phone_type fields.

Changes in Reserved User Data Keys

Table 35 lists the changes that occurred to data keys in Outbound Contact in 7.5 and 8.0. No changes were made to data keys in release 7.6. For more detailed information, see the *Outbound Contact 8.0 Deployment Guide*.

Table 35: Data Key Changes

Reserved User Data Key Name	Type of Change	Change Occurred in Version #	Details
GSW_CALL_TYPE	New key	8.0	Type of call leg, REGULAR or ENGAGING.
GSW_CONNECT_TIME	New key	8.0	Timestamp for call connection provided by SIP Server.
GSW_MEDIA_SRV_ID	New key	8.0	Identifier of the Media Server, used in an Outbound-VoIP environment.
GSW_QUEUE_DBID	New key	8.0	DBID of the Voice Transfer Destination DN, used in an Outbound-VoIP environment.
GSW_QUEUE_NAME	New key	8.0	Name of the Voice Transfer Destination DN, used in an Outbound-VoIP environment.
GSW_RECORD_URI	New key	8.0	URI for the record.
GSW_TRUNK_GROUP_DN_DBID	New key	8.0	DBID of the Trunk Group DN, used in an Outbound-VoIP environment.
GSW_TENANT_NAME	New key	8.0	Name of the Tenant for which the request is issued
GSW_CAMPAIGN_GROUP_NAME	New key	7.5	Name of the campaign group for which the request is issued.
GSW_CAMPAIGN_GROUP_DESCRIPTION	New key	7.5	Description of the campaign group for which the request is issued.
GSW_CONTACT_MEDIA_TYPE	New key	7.5	Media type corresponding to the Media Type Business Attribute Value.

Table 35: Data Key Changes (Continued)

Reserved User Data Key Name	Type of Change	Change Occurred in Version #	Details
GSW_AGENT_ID	New key	7.5	AgentID of the agent that is assigned for personal callback.
GSW_SWITCH_DBID	New key	7.5	DBID of the switch (avoids problems with Agent ID in personal callbacks).
InteractionType	New key	7.5	Type of the interaction that is created by OCS. The value of this key is always set to Outbound.
InteractionSubtype	New key	7.5	Subtype of the interaction, that is created by OCS. The value of this key is always set to OutboundNew.

Changes in Fields and Field Values

Table 36 lists the changes that occurred to fields and field values. For more detailed information about these fields, see the *Outbound Contact 8.0 Deployment Guide*.

Note: No changes were made to fields or field values in release 7.5, 7.6, or 8.0.

Table 36: Field Changes

Field Name in 7.2	Type of Change	Change Occurred in Version #	Details
group_id	New field	7.2	Stores the DBID of the Agent/Place Group configuration object.
switch_id	New field	7.2	Stores the DBID of the Switch configuration object.

Table 36: Field Changes (Continued)

Field Name in 7.2	Type of Change	Change Occurred in Version #	Details
treatments	New field	7.2	Saves the information required to properly restore the Treatment application sequence.
media_ref	New field	7.1	Reserved for future use.
email_subject	New field	7.1	Reserved for future use.
email_template_id	New field	7.1	Reserved for future use.
contact_info	Field renamed	7.0	The phone field in 6.5.1 is renamed contact_info in 7.0 to accommodate various forms of contact, such as, e-mail address and FAX number as well as phone number. The contact_info field is part of the default format for the 7.0 Calling List table.
contact_info_type	Field renamed.	7.0	The phone_type field in 6.5.1 is renamed contact_info_type in 7.0 The contact_info_type field is part of the default format for the 7.0 Calling List table.
app_id	Fields reserved	7.0	Reserved for future use.

Changes in Calling Lists and Formats

The following changes also support the migration of Calling Lists:

- Genesys Administrator 8.x and Outbound Contact Manager (OCM) 7.x and higher are capable of importing and exporting calling lists that belong to different databases and even different DBMS.

For OCM versions previous to 7.x, OCM did not perform import and export operations between two calling lists that belonged to different databases. OCM 7.x (and higher) removes this restriction. Both the source

and the destination calling lists must belong to database servers with the same DBMS type. See *OCM Help* (release 7 or higher) for import and export procedures.

- OCS release 7.1 supports calling lists based on the 6.5.2 to 7.1 formats. OCM 7.1 also allows the importation of 6.5.2 calling lists into 7.1 format.
- OCS 7.2 requires that all Calling Lists have the mandatory fields of the `switch_id`, `group_id`, and `treatments` in its associated format, as well as in physical database table. For more information, see Chapter 19 on [page 277](#) for migration procedures.

Changes in Licensing

Release 8.0

Outbound Contact 8.0 requires an 8.0 license. If you want to run Outbound Contact in a mixed environment (in which some Outbound Contact components are release 8.0, and others are release 7.5 or 7.6), both 7.x and 8.0 licenses must be present on License Server. With the exception of Push Preview and Power GVP, all dialing modes require Outbound Contact licenses.

Release 7.6

There were no licensing changes in release 7.6.

Release 7.5 and Dialing Modes

There is no change in Genesys licensing in release 7.5 for dialing modes that existed before the 7.5 release.

Dialing modes that are new in release 7.5 are licensed as follows:

- Push Preview and Power GVP dialing modes do not require Outbound Contact licenses. However, they do require their own respective application licenses.
- Each CPD port will still use one Genesys license. However, three types of Dialogic HMP licenses are required for each successful outbound call:
 - 1 license for Voice (dxxx)
 - 2 licenses for RTP_G_711
 - 2 licenses for IP_Call_Control (ipt)

Contact your Dialogic representative for more information about HMP licensing.



Chapter

19

Outbound Contact Migration Procedures

This chapter presents the procedures for migrating to Outbound Contact.

The following sections are included in this chapter:

- [Migration to 8.0, page 277](#)
- [Migration from 7.5 to 7.6, page 280](#)
- [Migration from 7.2 to 7.5, page 282](#)
- [Migration from 7.1 to 7.2, page 286](#)
- [Migration from 7.0 to 7.1, page 290](#)
- [Migration from 6.5.2 to 7.2, page 290](#)
- [Migration from 6.5.100.27-6.5.100.30 to 7.0, page 292](#)
- [Migration from 6.5.xxx-6.5.100.26 to 7.0, page 295](#)
- [Migration from 5.1.5, 6.0, or 6.1, page 298](#)

This section presents OCS-specific migration procedures. The other Outbound Contact components in this migration path follow the usual upgrade procedures.

Migration to 8.0

There are two ways to migrate to Outbound Contact 8.0.

- Upgrade existing components to the 8.0 release.
- Create a new solution using the procedure described in “Migration from 7.2 to 7.5” on [page 282](#) for Outbound Contact Server, CPD Server, and CPD Server Proxy.

Migration Notes 8.0

- Release 8.0 Outbound Contact components are backward compatible with the 7.6 and 7.5 releases of those components.
- New data keys were introduced in release 8.0. For more information, see “Changes in Reserved User Data Keys” on [page 271](#).
- A new dialing mode, Progressive GVP, was introduced in release 8.0. In addition, some of the existing dialing modes can now be used in a VoIP environment. For more information, see the *Outbound Contact 8.0 Deployment Guide*.
- New options were introduced in release 8.0. For more information, see “Changes in Configuration Options” on [page 254](#).
- Extensions to the desktop protocol were introduced in release 8.0 to prevent the canceling of records on the desktop. For more information, see “cancel-on-desktop” on [page 255](#).

Note: In release 8.0, Genesys Administrator replaces Configuration Manager and Outbound Contact Manager (OCM). Genesys Administrator provides the capability to provision, monitor, and deploy Outbound Contact 8.0 and other Genesys solutions. It also includes the ability to manage all related Campaigns activities. For information on Genesys Administrator, see the *Framework 8.0 Genesys Administrator Deployment Guide*.

Migration Procedure

Once you have completed the Framework migration and installed and configured Genesys Administrator, follow the procedures below to upgrade Outbound Contact to 8.0.

Server Application Upgrade Procedure

This section provides instructions on how to upgrade to the 8.0 release of OCS, CPD Server, and CPD Server Proxy using Genesys Administrator.

-
- Notes:**
- If you are running primary/backup servers, you can upgrade the pair as a non-stop operation. This includes upgrading the backup server, switching over from the primary to the backup server, and finally upgrading the primary server.
 - You can also use Configuration Manager to perform the upgrade.
 - When upgrading an existing component, you should not create a new Application object. Instead, use the existing Application object (keeping the original name) and update it by adding the new options available for use with your newly installed executable, removing obsolete options, and, if necessary, adjusting the values for existing options.
-

1. Install the 8.0 release of Outbound Contact Server (OCS) to a different directory on the same computer where the current component is installed. If you are using the optional CPD Server and CPD Server Proxy components, install those as well, using the same procedure.

Note: For installation instructions, see the *Outbound Contact 8.0 Deployment Guide*.

2. In Genesys Administrator, under Provisioning > Environment > Applications, double-click the Application object.
3. From the Options tab, export the current configuration options to a configuration file.

Note: Do not modify this text file. Preserve it as it is for comparison, as described in the next step, or to use for rollback purposes (in case the migration fails). For rollback instructions, see “Server Application Rollback Instructions” on [page 280](#).

4. Open the file in a text editor and compare the list of options in Table 34, “Configuration Option Changes,” on [page 254](#) with those in the text file to see if any option is obsolete or replaced in the new release.
5. Based on the comparison, add the new options to the Options tab of the appropriate Application object. Also, remove obsolete options, and, if necessary, adjust the values for existing options.

6. On the **Configurations** tab of the server application, in the **Connections** section, verify that the proper connections are still in place for the server. See the *Outbound Contact 8.0 Deployment Guide* for information on connections.
7. If necessary, change the settings in the tabs/sections of this object.
8. Click **OK** to save the changes and close the dialog box.

Server Application Rollback Instructions

If you experience problems upgrading to the 8.0 version, you can return to your existing previous configuration by doing the following:

1. In Genesys Administrator, under **Provisioning > Environment > Applications**, double-click the server **Application** object.

Note: You can also use Configuration Manager to perform the rollback.

2. On the **Options** tab, click **Import** and locate the configuration file you exported in [Step 3 on page 279](#).
This procedure overwrites the options on this tab with those in the configuration file.
3. If you changed settings on other tabs, return them to their previous settings.
4. Click **OK** to save the changes and close the dialog box.

Migration from 7.5 to 7.6

There are two ways to migrate to Outbound Contact 7.6.

- Upgrade existing components to the latest release.
- Create a new solution, using a procedure described in “Migration from 7.2 to 7.5” on [page 282](#).

Migration Notes from 7.5 to 7.6

Be aware of the following:

- Release 7.6 Outbound Contact components are backward compatible with the 7.5 components.
- No new data keys were introduced in release 7.6.

Migration Procedure

Once you have completed the Framework migration, follow the procedures below to upgrade Outbound Contact to 7.6.

Server Application Upgrade Procedure

This section provides instructions on how to upgrade to release 7.6 of OCS, CPD Server, and CPD Server Proxy.

-
- Notes:**
- If you are running primary/backup servers, you can upgrade the pair as a non-stop operation. This includes upgrading the backup server, switching over from the primary to the backup server, and finally upgrading the primary server.
 - When upgrading an existing component, you should not create a new Application object. Instead, use the existing Application object (keeping the original name) and update it by adding the new options available for use with your newly installed executable, removing obsolete options, and, if necessary, adjusting the values for existing options.
-

1. Install the 7.6 release of Outbound Contact Server (OCS) and Outbound Contact Manager (OCM) to different directories on the same computer where the current components are installed.

If you are using the optional CPD Server and CPD Server Proxy components, install those as well, using the same procedure.

Note: For installation instructions, see the *Outbound Contact 7.6 Deployment Guide*.

2. In Configuration Manager, open the Properties dialog box for the Application object.

Note: To view the Annex tab in the Properties dialog box, select Options from the View menu. On the General tab of the Options dialog box, select the Show Annex tab in object properties check box. Click OK to close the dialog box.

3. From the Options tab, export the current configuration options to a configuration file.

Note: Do not modify this text file. Preserve it as it is for comparison, as described in the next step, or to use for rollback purposes (in case the migration fails). For rollback instructions, see “Server Application Rollback Instructions” on [page 282](#).

4. Open the file in a text editor and compare the list of options in Table 34, “Configuration Option Changes,” on [page 254](#) with those in the text file to see if any option is obsolete or replaced in the new release.

5. Based on the comparison, add the new options to the Options tab of the appropriate Application object. Also, remove obsolete options, and, if necessary, adjust the values for existing options.
6. Verify on the Connections tab that the proper connections are still in place for the server. See the *Outbound Contact 7.6 Deployment Guide* for information on connections.
7. If necessary, change the settings in the remaining tabs of the Properties dialog box.
8. Click OK to save the changes and close the dialog box.

Server Application Rollback Instructions

If you experience problems upgrading to the 7.6 version, you can return to your existing previous configuration by doing the following:

1. In Configuration Manager, open the Properties dialog box for the Application object.
2. On the Options tab, click the Import from Configurations File icon and locate the configuration file you exported in [Step 3](#) on [page 281](#).
This procedure overwrites the options on this tab with those in the configuration file.
3. If you changed settings on other tabs, return them to their previous settings.
4. Click OK to save the changes and close the dialog box.

Outbound Contact Manager Upgrade Procedures

1. Install and configure the 7.6 version of OCM.

Note: For more information see the *Outbound Contact 7.6 Deployment Guide*.

2. Verify that a connection to Outbound Contact Server is configured on the Connections tab of the OCM Application object in Configuration Manager.

Migration from 7.2 to 7.5

Preliminary Procedures

You must be migrating from release 7.2 before performing these steps. Complete these preliminary procedures before starting your migration to Outbound Contact 7.5.

1. If you are using Dialogic's Host Media Processing (HMP) software, you should obtain the necessary license file from Dialogic.

Genesys licensing is addressed in these documents:

- *Genesys Licensing Guide*
- [Chapter 2, "Licensing Migration"](#) in this guide.

2. Migrate Framework from 7.2 to 7.5.

The migration of the Outbound CampaignGroupInfo object to the CampaignGroup object is performed by the Configuration Conversion Wizard (CCW). Framework migration is explained in detail in the Framework section in this guide.

Note: Starting with release 7.5, the backup OCS application maintains a direct connection to the primary OCS application. Previously, the backup OCS application monitored UserEvents that were distributed by the primary OCS application using the T-Server application. As a result, you cannot migrate your backup OCS application, perform a switchover, and then migrate your primary OCS application. You must stop your Outbound Contact solution before migrating to release 7.5.

3. Upgrade other Genesys components that Outbound Contact will use.
4. Review the section "Interoperability Among Outbound Contact Components" on [page 239](#) in this guide.

Migration Procedures

Outbound Contact release 7.5 is not backward compatible with Genesys release 7.2 or earlier. Genesys recommends that you install Outbound Contact 7.5 components in a new directory, separate from the Outbound Contact installation directory.

Note: Genesys recommends that you use the Outbound Solution Wizard (also known as the Outbound Contact Configuration Wizard) to perform this step and to complete the upgrade procedures for OCS, OCM, and CPD Server (optional).

The Wizard creates a standard configuration of the components of Outbound Contact 7.5. The Wizard creates all mandatory options with their default values. You can easily redefine these default values based on the specific needs of your contact center. The Wizard also provides a method for setting up the Dialogic board channels (ports) for CPD Server only when you create a new CPD Server application.

For instructions on using the Wizard, refer to the *Outbound Contact 7.5 Deployment Guide*.

Follow these procedures for migrating to Outbound Contact 7.5:

1. Import the Solution template for Outbound Contact 7.5.
2. Import the Application template for Outbound Contact Server 7.5.
3. Create and configure the Application object for Outbound Contact Server 7.5.
4. Install the 7.5 release of Outbound Contact Server (OCS) and Outbound Contact Manager (OCM) to different directories on the same computer where the current components are installed.

If you are using the optional CPD Server and CPD Server Proxy components, install those as well, using the same procedure.

Notes: For assistance with installation and also manual configurations, if necessary, refer to the *Outbound Contact 7.5 Deployment Guide*.

If objects and components have been customized, contact Genesys Professional Services for help.

Rollback Procedures: If the upgrade of Outbound Contact Server 7.5 fails, simply uninstall OCS 7.5.

5. Import the Application template for Outbound Contact Manager 7.5.
6. Create and configure the Application Object for Outbound Contact Manager 7.5.

Note: For assistance with manual configurations, if needed, refer to the *Outbound Contact 7.5 Deployment Guide*.

Rollback Procedures: If the upgrade of OCM 7.5 fails, simply uninstall OCM 7.5.

Steps 6 to 9 are optional if you are using switch-based call progress detection.

7. Import the Application template for CPD Server 7.5.
8. Create and configure the Application object for CPD Server 7.5.

Note: For assistance with manual configurations, if needed, refer to the *Outbound Contact 7.5 Deployment Guide*.

Rollback Procedures: If the upgrade of CPD Server 7.5 fails, simply uninstall CPD Server 7.5.

9. Import the Application template for CPD Server Proxy 7.5 if you choose to use this new 7.5 component.

10. Create and configure the Application object for CPD Server Proxy 7.5.

Note: For assistance with manual configurations, if needed, refer to the *Outbound Contact 7.5 Deployment Guide*.

Rollback Procedures: If the import and configuration of CPD Server Proxy 7.5 fails, simply uninstall CPD Server Proxy 7.5.

11. There are new data keys in Outbound Contact 7.5:

- GSW_CAMPAIGN_GROUP_NAME
- GSW_CAMPAIGN_GROUP_DESCRIPTION
- GSW_CONTACT_MEDIA_TYPE
- GSW_AGENT_ID
- GSW_SWITCH_DBID
- InteractionType
- InteractionSubtype

Refer to the *Outbound Contact 7.5 Reference Manual* for more information about these keys.

12. Fields in the calling list tables are updated as part of the CCW conversion procedure.

Note: OCM Help also explains how to import and export Calling List data. See the *OCM 7.5 Help* file for more information.

13. In Configuration Manager, you must perform the following steps:

- Configure the CampaignGroup object in the Campaign object.
- Add a Stat Server application in the Connections tab of the CampaignGroup object.

Note: If you require ADDP for connections between OCS and the other servers, you must add those servers to the Connections tab of the OCS Application object and also configure ADDP and other optional connection parameters. See the *Outbound Contact 7.5 Deployment Guide* for more details.

14. Reporting templates have not changed since release 7.2. See the Reporting solution documentation for more information about migrating reporting templates for versions previous to release 7.2.

Note: In release 7.5, the following three outbound-specific statistics were added: `CurrentAgentAssignment`, `CurrentNumberAgentsAssigned`, and `CurrentCampaignGroupDBID`. For more information about these statistics, see the “Outbound-Specific Statistics for Stat Server” section in Chapter 5 of the *Outbound Contact 7.6 Deployment Guide*.

Migration from 7.1 to 7.2

You can migrate Outbound Contact directly from release 7.1 to release 7.2. The procedures for this specific migration path are discussed in this section.

Preliminary Procedures

Complete these preliminary procedures before starting your migration to Outbound Contact 7.2:

1. Install Licensing Manager.

You should have the license files for 7.2 components.

Licensing is addressed in these documents:

- *Genesys Licensing Guide*
- [Chapter 2, “Licensing Migration”](#) in this guide.

2. Migrate Framework from 7.1 to 7.2:

Framework migration is explained in detail in the Framework section in this guide.

3. Upgrade other prerequisite Genesys components.

Review the section “Interoperability Among Outbound Contact Components” on [page 239](#) in this guide.

Migration Procedures

Follow these migration procedures for Outbound Contact (Steps 1-12):

1. Update contact center configuration (specific to Outbound Contact), as needed.
 - a. Place Groups
 - b. Agent Groups
 - c. DNSs

For additional information about Place Groups, Agent Groups, and DNAs as configuration objects, refer to the *Outbound Contact 7.2 Deployment Guide*.

2. Import the Solution template for Outbound Contact 7.2.

Genesys recommends that you install Outbound Contact 7 components in a new directory, separate from Outbound Contact 7.1.

Genesys also recommends that you use the Outbound Solution Wizard (also known as the Outbound Contact Configuration Wizard) to perform this step and to complete the upgrade procedures for these components: OCS, OCM, CPD Server (optional) and CPD Proxy Server (optional).

The Wizard creates a standard configuration of the components of Outbound Contact 7.2. The Wizard creates all mandatory options with their default values. You can easily redefine these default values based on the specific needs of your contact center. The Wizard also provides a method for setting up the Dialogic board channels (ports) for CPD Server.

For instructions on using the Wizard, refer to the *Outbound Contact 7.2 Deployment Guide*.

To determine if the first component you plan to upgrade to version 7.2 is backward compatible with the components not yet upgraded, refer to the section “Interoperability Among Outbound Contact Components” on [page 239](#) in this guide.

3. Import the Application template for Outbound Contact Server 7.2.

4. Create and configure the Application Object for Outbound Contact Server 7.2.

For assistance with manual configurations, if necessary, refer to the *Outbound Contact 7.2 Deployment Guide*.

Note: If objects and components have been customized, contact Genesys Professional Services for help.

Rollback Procedures: If the upgrade of Outbound Contact Server 7.2 fails, simply uninstall OCS 7.2.

5. Import Application template for Outbound Contact Manager 7.2.

6. Create and configure the Application Object for Outbound Contact Manager 7.2.

For assistance with manual configurations, if needed, refer to the *Outbound Contact 7.2 Deployment Guide*.

Rollback Procedures: If the upgrade of OCM 7.2 fails, follow these steps:

- a. Uninstall OCM 7.2.
- b. Reinstall OCM 7.1.

7. Import Application template for CPD Server 7.2.
8. Create and configure the Application Object for CPD Server 7.2.
For assistance with manual configurations, if needed, refer to the *Outbound Contact 7.2 Deployment Guide*.
Rollback Procedures: If the upgrade of CPD Server 7.2 fails, simply uninstall CPD Server 7.2.
9. Import the Application template for CPD Proxy Server 7.2 if you choose to use this new 7.2 component.
10. Create and configure the Application Object for CPD Proxy Server 7.2.
For assistance, refer to the *Outbound Contact 7.2 Deployment Guide*.
Rollback Procedures: If the import and configuration of CPD Proxy Server 7.2 fails, simply uninstall CPD Proxy Server.
11. There are two ways you can migrate data specific to Outbound Contact - manual and automatic. Each procedure is described as follows.

Note: OCM Help also explains how to import and export Calling List data from 7.1 format to 7.2 format. For more information, see *OCM 7.2 Help*.

Manual Migration

The migration of calling list data manually Outbound Contact 7.1 to version 7.2 requires that all Calling Lists have the mandatory `switch_id`, `group_id`, and `treatments` fields in the associated format, as well as in the physical database table. Calling lists that are associated with formats that do not contain these 3 fields (such as those from version 7.0 or earlier, or that contain the fields `phone` and `phone_type` instead of `contact_info` and `contact_info_type` respectively) must be migrated to Outbound Contact Solution 7.1. Only calling lists based on a 7.1 format can be migrated to Outbound Contact Solution 7.2.

To migrate the calling list data from Outbound Contact 7.1. to 7.2, complete the following steps:

1. Create a new `format` object (by making a copy of the existing format object).
2. In the new format, add shortcuts to the field objects: `switch_id`, `group_id`, and `treatments` from the `Environment\Fields` folder.

Note: If these fields do not exist in the `Fields` folder, you will need to upgrade your configuration database. Refer to previous sections in this chapter for instructions about how to complete this process.

3. Create a new `table access point` object, then copy the properties from the existing `table access point` object, and then assign a new format to it.

4. Assign the new table access point to the calling list object.
5. Alter the database to add the new fields using the appropriate syntax:
 - a. For MSSQL or Sybase databases, use the following SQL statement to add new fields to your calling list database tables:

```
Alter Table <table_name> ADD group_id INT NULL, switch_id INT NULL, treatments VARCHAR (255) NULL
```
 - b. For the Oracle database, use the following statement to add new fields to your calling list database tables:

```
Alter Table <table_name> ADD (group_id INT NULL, switch_id INT NULL, treatments VARCHAR2(255) NULL)
```
 - c. For DB2 and Informix databases, use the following statements to add new fields to your calling list database tables:

```
Alter Table <table_name> ADD group_id INT  
Alter Table <table_name> ADD switch_id INT  
Alter Table <table_name> ADD treatments VARCHAR(255)
```

Automatic Migration

The migration of calling list data automatically from Outbound Contact 7.1 to version 7.2 requires the update of the configuration database by using the Conversion Configuration Wizard.

The migration process is as follows:

1. Stop all applications that access the Configuration Server and those that use the database to be migrated.
2. Stop Configuration Server.
3. Backup the Configuration Database.
4. Run the Conversion Configuration Wizard (CCW) and follow the Wizard prompts.
5. Restart Configuration Server.
6. Start Configuration Manager, then check to ensure that all of the formats associated with the calling lists have been updated.
7. Alter the database tables to add the new fields using the appropriate syntax for your installation. For more information, refer to “Manual Migration” on [page 288](#).

Note: You can use CCW to migrate the configuration database from release 7.1 to release 7.2, 7.5, or 7.6. For more information about CCW, see the Framework migration chapters in this *Genesys Migration Guide*.

For more information about migrating reporting templates to Outbound Contact 7.2, see:

- *Reporting 7 CCPulse+ Help*, “Using the Import/Export Utility”.

- *Reporting 7 Data Modeling Assistant Help*, “Importing and Exporting Templates”.

Migration from 7.0 to 7.1

The migration procedures for the Outbound Contact 7.0.1 and 7.1 releases are the same as the Outbound Contact 7.0 release. If you are upgrading to Outbound Contact 7.0.1 or 7.1, follow the previous procedures that this guide describes for Outbound Contact 7.0.

Migration from 6.5.2 to 7.2

You can migrate Outbound Contact directly from release 6.5.2 to release 7.2. The procedures for this specific migration path are discussed in this section.

Preliminary Procedures

Complete these preliminary procedures before starting your migration to Outbound Contact 7.2:

1. Install Licensing Manager.

You should have the license files for 7.2 components.

Licensing is addressed in these documents:

- *Genesys Licensing Guide*
- “Licensing Migration” section in this guide.

2. Migrate Framework from 6.5 to 7.2.

Framework migration is explained in detail in the Framework section in this guide.

3. Upgrade other prerequisite Genesys components.

4. Review the section “Interoperability Among Outbound Contact Components” on [page 239](#) in this guide.

Migration Procedures

Follow these migration procedures for Outbound Contact (Steps 1-12):

1. Update contact center configuration (specific to Outbound Contact), as needed.
 - Place Groups
 - Agent Groups
 - DNS

For additional information about Place Groups, Agent Groups, and DNAs as configuration objects, refer to the *Outbound Contact 7.2 Deployment Guide*.

2. Import the Solution template for Outbound Contact 7.2.

Genesys recommends that you install Outbound Contact 7 components in a new directory, separate from Outbound Contact 6.5.2.

Genesys also recommends that you use the Outbound Solution Wizard (also known as the Outbound Contact Configuration Wizard) to perform this step and to complete the upgrade procedures for these components: OCS, OCM, CPD Server (optional) and CPD Proxy Server (optional).

The Wizard creates a standard configuration of the components of Outbound Contact 7.2. The Wizard creates all mandatory options with their default values. You can easily redefine these default values based on the specific needs of your contact center. The Wizard also provides a method for setting up the Dialogic board channels (ports) for CPD Server.

For instructions on using the Wizard, refer to the *Outbound Contact 7.2 Deployment Guide*.

To determine if the first component you plan to upgrade to version 7.2 is backward compatible with the components not yet upgraded, refer to the section “Interoperability Among Outbound Contact Components” on [page 239](#) in this guide.

3. Import the Application template for Outbound Contact Server 7.2.

4. Create and configure the Application Object for Outbound Contact Server 7.2.

For assistance with manual configurations, if necessary, refer to the *Outbound Contact 7.2 Deployment Guide*.

Note: If objects and components have been customized, contact Genesys Professional Services for help.

Rollback Procedures: If the upgrade of Outbound Contact Server 7.2 fails, simply uninstall OCS 7.2.

5. Import Application template for Outbound Contact Manager 7.2.

6. Create and configure the Application Object for Outbound Contact Manager 7.2.

For assistance with manual configurations, if needed, refer to the *Outbound Contact 7.2 Deployment Guide*.

Rollback Procedures: If the upgrade of OCM 7.2 fails, follow these steps:

- a. Uninstall OCM 7.2.
- b. Reinstall OCM 6.5.2.

7. Import Application template for CPD Server 7.2.
8. Create and configure the Application Object for CPD Server 7.2.
For assistance with manual configurations, if needed, refer to the *Outbound Contact 7.2 Deployment Guide*.
Rollback Procedures: If the upgrade of CPD Server 7.2 fails, simply uninstall CPD Server 6.5.2.
9. Import the Application template for CPD Proxy Server 7.2 if you choose to use this new 7.2 component.
10. Create and configure the Application Object for CPD Proxy Server 7.2.
For assistance, refer to the *Outbound Contact 7.2 Deployment Guide*.
Rollback Procedures: If the import and configuration of *CPD Proxy Server 7.2* fails, simply uninstall CPD Proxy Server.
11. Migrate data specific to Outbound Contact.
OCM Help explains how to import and export Calling List data from 6.5 format to the 7.2 format. See *OCM 7.2 Help*.

Note: Outbound Contact 7.2 is backward compatible with the 6.x format of the Calling Lists.

12. Migrate Reporting templates for Outbound Contact 7.2.
For information about importing Reporting templates for Outbound Contact 7.2, see:
 - *Reporting 7 CCPulse+ Help*, “Using the Import/Export Utility”
 - *Reporting 7 Data Modeling Assistant Help*, “Importing and Exporting Templates”

Migration from 6.5.100.27-6.5.100.30 to 7.0

Follow these migration procedures (Steps 1-12):

1. Update contact center configuration (specific to Outbound Contact), as needed.
 - Place Groups
 - Agent Groups
 - DNs
 - For additional information about Place Groups, Agent Groups, and DNs as configuration objects, refer to the *Outbound Contact 7.0 Deployment Guide*, Chapter 5, “Outbound-Specific Configurations of Framework Objects.”
2. Import the Solution template for Outbound Contact 7.0.

Genesys recommends that you install Outbound Contact 7 components in a new directory, separate from Outbound Contact 6.5.2.

Genesys also recommends that you use the Outbound Solution Wizard (also known as the Outbound Contact Configuration Wizard) to perform this step and to complete the upgrade procedures for these components: OCS, OCM, CPD Server (optional) and CPD Proxy Server (optional).

The Wizard creates a standard configuration of the components of Outbound Contact 7.0. The Wizard creates all mandatory options with their default values. You can easily redefine these default values based on the specific needs of your contact center. The Wizard also provides a method for setting up the Dialogic board channels (ports) for CPD Server.

For instructions on using the Wizard, refer to the *Outbound Contact 7.0 Deployment Guide*, Chapter 4, “Outbound Solution Wizard.”

To determine if the first component you plan to upgrade to version 7.0 is backward compatible with the components not yet upgraded, refer to the section “Interoperability Among Outbound Contact Components” on [page 239](#) in this guide.

3. Import the Application template for Outbound Contact Server 7.0.
4. Create and configure the Application Object for Outbound Contact Server 7.0.

For assistance with manual configurations, if necessary, refer to the *Outbound Contact 7.0 Deployment Guide*, Chapter 3, “Configuring OCS.”

Note: If objects and components have been customized, contact Genesys Professional Services for help.

Rollback Procedures: If the upgrade of Outbound Contact Server 7.0 fails, simply uninstall OCS 7.0.

5. Import Application template for Outbound Contact Manager 7.0.
6. Create and configure the Application Object for Outbound Contact Manager 7.0.

For assistance with manual configurations, if needed, refer to the *Outbound Contact 7.0 Deployment Guide*, Chapter 3, “Configuring OCM.”

Rollback Procedures: If the upgrade of OCM 7.0 fails, follow these steps:

- a. Uninstall OCM 7.0.
 - b. Reinstall OCM 6.5.x.
7. Import Application template for CPD Server 7.0.
 8. Create and configure the Application Object for CPD Server 7.0.

For assistance with manual configurations, if needed, refer to the *Outbound Contact 7.0 Deployment Guide*, Chapter 3, “Configuring CPD Server.”

Rollback Procedures: If the upgrade of CPD Server 7.0 fails, simply uninstall CPD Server 7.0.

9. Import the Application template for CPD Proxy Server 7.0 if you choose to use this new 7.0 component.
10. Create and configure the Application Object for CPD Proxy Server 7.0.

For assistance, refer to the *Outbound Contact 7.0 Deployment Guide*, Chapter 3, “Configuring Call Progress Detection Proxy.”

Rollback Procedures: If the import and configuration of CPD Proxy Server 7.0 fails, simply uninstall CPD Proxy Server.

11. Migrate data specific to Outbound Contact, such as:
 - Calling List Data
 - Do Not Call Data

OCM Help explains how to import and export Calling List data from 6.5 format to 7.0 format. See *OCM 7.0 Help*.

The migration of Do Not Call data from Outbound Contact 6.5.1 to 7.0 entails:

- Creating a new Table Access object in configuration.
- Creating a new database table in the database.
- Copying Do Not Call-related information from the old `gsw_request_log` table to the new `gsw_donotcall_list` table.

To Migrate Do Not Call data from Outbound Contact 6.5.1 to 7.0, follow these step-by-step procedures:

- a. Create a new Table Access object of the type “Log table.”

Note: For instructions on creating a Table Access object, see the *Outbound 7.0 Deployment Guide*, Chapter 5, section “Table Access Object.”

- b. In the Properties dialog box for this object, name this Table Access object `gsw_donotcall_list`.

Note: The exact name `gsw_donotcall_list` for the Table Access object allows OCS to distinguish this table. The table itself can have any name.

- c. Assign a Database Access Point for the `gsw_donotcall_list` table.

Use any Database Access Point that is convenient; there are no limitations on the physical location of this table.

- d. Run OCM to create the `gsw_donotcall_list` table.

Start OCM, select tenant, select OCS. OCM will automatically create the `gsw_donotcall_list` table in the database.

- e. Once the new database table is created, use the SQL statement below to copy the Do Not Call-related information from the old `gsw_request_log` table into the new table.

Before completing this step, please note the following:

To execute the `INSERT INTO` statement (below), you need permissions to modify tables.

You must replace:

- `<new_table_name>` placeholder with the actual `gsw_donotcall_list` table name, as configured in the Table Access Object.
- `<old_table_name>` placeholder with the actual `gsw_request_log` table name.

The exact syntax may vary for the `INSERT INTO` SQL statement, depending on your DBMS type. Check your DBMS documentation or consult your DBA, if necessary.

The following example is for an MS SQL Server:

```
INSERT INTO <new_table_name> (phone, dnc_message, time_stamp,
tenant_dbid)
SELECT phone, dnc_message, time_stamp, tenant_dbid FROM
<old_table_name>
WHERE request_type=15
```

Migrate Reporting templates for Outbound Contact 7.

For information about importing Reporting templates for Outbound Contact 7.0, see:

- *Reporting 7 CCPulse+ Help*, “Using the Import/Export Utility”
- *Reporting 7 Data Modeling Assistant Help*, “Importing and Exporting Templates”

Migration from 6.5.xxx-6.5.100.26 to 7.0

Note: If you are using Outbound Contact Server 6.5.100.26 or a previous version, you must upgrade OCS first, then upgrade the Framework components to 7.0.

Follow these migration procedures (Steps 1-12):

1. Update contact center configuration (specific to Outbound Contact), as needed.
 - Place Groups
 - Agent Groups
 - DNS
2. Import the Solution template for Outbound Contact 7.0.

Genesys recommends that you install Outbound Contact 7 components in a new directory, separate from Outbound Contact 6.5.2.

Genesys also recommends that you use the Outbound Solution Wizard (also known as the Outbound Contact Configuration Wizard) to perform this step and to complete the upgrade procedures for these components: OCS, OCM, CPD Server (optional) and CPD Proxy Server (optional).

The Wizard creates a standard configuration of the components of Outbound Contact 7.0. The Wizard creates all mandatory options with their default values. You can easily redefine these default values based on the specific needs of your contact center. The Wizard also provides a method for setting up the Dialogic board channels (ports) for CPD Server.

For instructions on using the Wizard, refer to the *Outbound Contact 7.0 Deployment Guide*.

To determine if the first component you plan to upgrade to version 7.0 is backward compatible with the components not yet upgraded, refer to the section “Interoperability Among Outbound Contact Components” on [page 239](#) in this guide.

3. Import the Application template for Outbound Contact Server 7.0.
4. Create and configure the Application Object for Outbound Contact Server 7.0.

For assistance with manual configurations, if necessary, refer to the *Outbound Contact 7.0 Deployment Guide*, Chapter 3, “Configuring OCS.”

Note: If objects and components have been customized, contact Professional Services for help.

Rollback Procedures: If the upgrade of Outbound Contact Server 7.0 fails, simply uninstall OCS 7.0.

5. Import Application template for Outbound Contact Manager 7.0.
6. Create and configure the Application Object for Outbound Contact Manager 7.0.

For assistance with manual configurations, if needed, refer to the *Outbound Contact 7.0 Deployment Guide*, Chapter 3, “Configuring OCM.”

- a. Uninstall OCM 7.0.
 - b. Reinstall OCM 6.5.x.
7. Import Application template for CPD Server 7.0.
 8. Create and configure the Application Object for CPD Server 7.0.

For assistance with manual configurations, if needed, refer to the *Outbound Contact 7.0 Deployment Guide*, Chapter 3, “Configuring CPD Server.”

Rollback Procedures: If the upgrade of CPD Server 7.0 fails, simply uninstall CPD Server 7.0.

9. Import the Application template for CPD Proxy Server 7.0 if you choose to use this new 7.0 component.

10. Create and configure the Application Object for CPD Proxy Server 7.0.

For assistance, refer to the *Outbound Contact 7.0 Deployment Guide*, Chapter 3, “Configuring CPD Proxy Server.”

Rollback Procedures: If the upgrade fails, simply uninstall CPD Proxy Server.

11. Migrate data specific to Outbound Contact, such as

- Calling List Data
- Do Not Call Data

OCM Help explains how to import and export Calling List data from 6.5 format to 7.0 format. See *OCM 7.0 Help*.

The migration of Do Not Call data from Outbound Contact 6.5.1 to 7.0 entails:

- Creating a new Table Access object in configuration.
- Creating a new database table in the database.
- Copying Do Not Call-related information from the old `gsw_request_log` table to the new `gsw_donotcall_list` table.

Step-by-step procedures for the migration of Do Not Call data follow.

To migrate Do Not Call data from Outbound Contact 6.5.1 to 7.0:

- a. Create a new Table Access object of the type “Log table.”

Note: For instructions on creating a Table Access object, see the *Outbound 6.5 Deployment Guide*, Chapter 5, section “Table Access Object.”

- b. In the Properties dialog box for this object, name this Table Access object `gsw_donotcall_list`.

Note: The exact name `gsw_donotcall_list` for the Table Access object allows OCS to distinguish this table. The table itself can have any name.

- c. Assign a Database Access Point for the `gsw_donotcall_list` table. Use any Database Access Point that is convenient; there are no limitations on the physical location of this table.
- d. Run OCM to create the `gsw_donotcall_list` table.

Start OCM, select tenant, select OCS. OCM will automatically create the `gsw_donotcall_list` table in the database.

- e. Once the new database table is created, use the SQL statement below to copy the Do Not Call-related information from the old `gsw_request_log` table into the new table.

Before completing this step, please note the following:

To execute the `INSERT INTO` statement (below), you need permissions to modify tables.

You must replace:

- `<new_table_name>` placeholder with the actual `gsw_donotcall_list` table name, as configured in the Table Access Object.
- `<old_table_name>` placeholder with the actual `gsw_request_log` table name.

The exact syntax may vary for the `INSERT INTO` SQL statement, depending on your DBMS type. Check your DBMS documentation or consult your DBA, if necessary.

The following example is for an MS SQL Server:

```
INSERT INTO <new_table_name> (phone, dnc_message, time_stamp,
tenant_dbid)
SELECT phone, dnc_message, time_stamp, tenant_dbid FROM
<old_table_name>
WHERE request_type=15
```

For information about importing Reporting templates for Outbound Contact 7.0, see:

- *Reporting 7 CCPulse+ Help*, “Using the Import/Export Utility”
- *Reporting 7 Data Modeling Assistant Help*, “Importing and Exporting Templates”

Migration from 5.1.5, 6.0, or 6.1

If you are using OCS 5.1.5, 6.0, or 6.1, follow this two-step migration path:

- See the *Genesys 6.5 Migration Guide* for instructions about upgrading to OCS 6.5.2 first.
- Migrate OCS 6.5.2 to 7.2. For more information, see “Migration from 6.5.2 to 7.2” on [page 290](#).



Part

5

T-Server Migration

This section describes migration from pre-8.0 releases to release 8.0 of T-Server and Network T-Server products. It discusses component changes, and Genesys software that supports and enables T-Server and Network T-Server functionality.

The information is divided into the following chapters:

- [Chapter 20, “Introduction to T-Server Migration,” on page 301](#) provides background information on T-Server migration.
- [Chapter 21, “Changes in T-Server and HA Proxy Configuration Options,” on page 307](#) offers a list of configuration options that may have changed since you last deployed T-Server.
- [Chapter 22, “T-Server Migration Procedures,” on page 429](#) provides the required steps to migrate T-Server. It also includes the steps you need to take for migration of HA Proxy components, if you use them in your enterprise.



Chapter

20

Introduction to T-Server Migration

This chapter provides background information on how to migrate and upgrade the T-Server and Network T-Server products. Basic information about T-Servers and T-Server options is available in your *T-Server Deployment Guide*.

This chapter discusses the following topics:

- [Preliminary Migration Procedures, page 301](#)
- [Migration Considerations, page 302](#)
- [Interoperability Among Framework Components, page 305](#)

Note: References to T-Server in these chapters also apply to Network T-Servers, except where noted.

Preliminary Migration Procedures

Note: If you want to upgrade your operating system, you must do this before migrating your Genesys product.

The migration process includes these preliminary procedures for T-Servers:

1. Review Chapter 1, “Migration Roadmap,” on [page 35](#) of this guide.
2. Examine the order in which the Genesys software required for Framework 8.0 should be upgraded. See “Order of Migration for 8.0” on [page 61](#).
3. Examine the component changes for T-Servers in Chapter 21, “Changes in T-Server and HA Proxy Configuration Options,” on [page 307](#).
4. You might also want to look at the option changes in that same chapter.

Note: These tables only discuss changes that directly affect the migration of this product. For a complete list of configuration options for T-Server, see the specific *T-Server Deployment Guide*. For a list of documentation relevant to the migration of this product, see “Reference Materials” below.

5. Review the licensing requirements for Framework 8.0. See Chapter 2, “Licensing Migration,” on [page 41](#) in this guide.
6. Check the interoperability of the components of Framework 8.0 during the upgrade procedures.

See *Genesys 8 Interoperability Guide* for information on the compatibility of Genesys products with various Configuration Layer Environments; Interoperability of Reporting Templates and Solutions; and *Gplus* Adapters Interoperability.

- Reference Materials**
- *T-Server 8.0 Deployment Guide* (for a specific T-Server)
 - *Framework 8.0 Deployment Guide*
 - *Genesys Licensing Guide*
 - *Genesys 8 Interoperability Guide*

Migration Considerations

Migration paths depend on the version of the specific T-Server you are migrating. In all cases it is assumed you are migrating to the most recent version of your T-Server. (Thus, for example, a heading such as “Migration from 7.6” means “Migration from Release 7.6 of T-Server to the most recent release of T-Server.”)

Multi-Site/Single-Site and Multi-Tenant Migration

T-Server migration requires planning system operation during the migration process:

- Single-Site Migration**
 - In single-site migrations, you need to suspend work in your production environment during the T-Server migration process.
- Multi-Site Migration**
 - In multi-site environments, while you are undergoing the migration process, you need to reroute work through another T-Server during upgrade in order to avoid suspending work.

Redundant T-Servers

Since T-Servers can operate in a high-availability (HA) configuration, providing you with redundant systems, you may be migrating multiple servers.

In the cases of both primary and backup T-Servers, the migration process is the same.

Hot Standby Redundancy Type

Starting with release 7.1, hot standby redundancy type is implemented in T-Servers for most types of switches. For some switches, you must compensate for the lack of link redundancy by using an additional Genesys component called HA Proxy.

See “HA Environment Migration” on [page 434](#) in Chapter 22, “T-Server Migration Procedures,” on [page 429](#) and see Chapter 21, “Changes in T-Server and HA Proxy Configuration Options,” on [page 307](#).

Historical Changes to T-Server

The history of T-Server has seen a few larger-scale developments. The two most important are:

- Expiration of support for configuration files when deploying T-Server. Your new version of T-Server requires that you use Configuration Manager to configure it and store all settings in the Configuration Database, not in a configuration file.
- Introduction of some support for a high-availability deployment with all T-Servers. While warm standby mode is available for all T-Servers, hot standby mode in its many variations is not available for some T-Servers. You must refer to the *T-Server 8.0 Deployment Guide* for your specific T-Server for information on hot-standby support.

Note: Network T-Servers use a load-sharing redundancy schema instead of warm or hot standby.

Most changes, however, involve small differences to your T-Server. Changes of this type are evident, for instance, in the addition of new options and alterations to valid option values.

These T-Server migration chapters highlight most of the changes to T-Server that will concern you during migration. However, refer to your specific *T-Server 8.0 Deployment Guide* as needed and carefully read all the instructions presented for your specific migration path before beginning the migration process.

Required Framework Components

T-Servers are part of the Framework Media Layer. Refer to Framework 8.0 documentation to learn about the role of T-Server in the Media Layer, and about the Media Layer’s role within the overall scope of a Framework migration. Be sure to refer to earlier portions of this guide which provide an overall picture of the larger migration process for all your Genesys components and identify the specific point at which T-Servers are migrated.

Note: Be sure to upgrade or install components of the Framework Configuration Layer before you migrate your T-Servers.

Licensing Changes

Regardless of which version of T-Server you have prior to migrating, be sure to check on the licensing requirements for the new version. In all cases, refer to the *Genesys Licensing Guide* available on the Technical Support Website for more information.

Note: In the Genesys 8 Framework, high-availability configurations do not require duplicate licenses. The HA license for your T-Server applies to both the primary and backup T-Servers.

Earlier Configuration Environment

T-Server 8.0 is fully backward compatible with the pre-8.0 release of T-Server clients. See “Interoperability Among Framework Components” on [page 305](#) for details on mixed environments. The 8.0 T-Server features can be configured using 8.0 Configuration Layer.

Note: Starting with release 7.5, the Keep-Alive Protocol (KPL) backward compatibility is no longer supported. If you have used the KPL with previous versions of Genesys, consider using ADDP after upgrading to 7.5. It provides the same functionality as KPL with fewer limitations. For more information on ADDP, see your *T-Server 8.0 Deployment Guide*.

Note: The 7.6 release of T-Server for Nortel Communication Server 2000/2100 is completely redesigned from 7.5. It now uses a new common framework called GCTM that provides consistency in behavior across Genesys T-Servers. Refer to the Changes from 7.5 to 7.6 section in chapter 10 of the Framework 7.6 T-Server and HA Proxy for Nortel Communication Server 2000/2100 Deployment Guide for details on changes to T-Server options in 7.6.

T-Server Enhancements

The following sections describe some of the major functional differences between the 8.0 and 7.6 releases of T-Server. See your *T-Server 8.0 Deployment Guide* for information on which of these changes apply to your particular T-Server.

Enhanced Event Propagation support for switch partitioning	T-Server now supports the Event Propagation feature in deployments that use switch partitioning or intelligent trunks.
Enhanced ISCC Transaction Monitoring support	T-Server now supports new key-value pairs in <code>AttributeExtensions</code> with ISCC transaction data requested using <code>TGetAccessNumber</code> in the following requests: <code>TMakeCall</code> , <code>TRouteCall</code> , <code>TSingleStepTransfer</code> , <code>TInitiateTransfer</code> , <code>TInitiateConference</code> , and <code>TMuteTransfer</code> . The ISCC Transaction Monitoring allows T-Server clients to monitor ISCC transactions of the call data transfer between T-Servers in a multi-site environment.
Enhanced Agent Reservation support	T-Server now supports Agent Reservation failure optimization, to ensure that only agent reservation requests of the highest priority are collected. This functionality can now be controlled with the <code>collect-lower-priority-requests</code> configuration option.
Link bandwidth reporting support	T-Server now supports notification of link bandwidth utilization. The following two new log events have been introduced: <ul style="list-style-type: none"> 20009 STANDARD MSG_TS_COMMON_LINK_ALARM_HIGH 20010 STANDARD MSG_TS_COMMON_LINK_ALARM_LOW Refer to <i>Framework 8.0 Combined Log Events Help</i> for information about the log events.
Notification of failed routing attempts and failed ISCC transactions	T-Server now supports notification of failed routing attempts and failed ISCC transactions. The following new log events have been introduced: <ul style="list-style-type: none"> 20011 STANDARD MSG_TS_COMMON_ALARM_ROUTE_FAILURE_HIGH_WATER_MARK 20012 STANDARD MSG_TS_COMMON_ALARM_ROUTE_FAILURE_LOW_WATER_MARK 21019 STANDARD ISCC_LOGMSG_TRANSACTION_FAILED Refer to <i>Framework 8.0 Combined Log Events Help</i> for information about the log events.
Real-time SDN licenses query support	8.0 T-Server can now report how many SDN licenses are currently available and in use, using the following key-value pairs in <code>AttributeExtensions</code> in <code>EventServerInfo</code> messages: <code>sdn-licenses-in-use</code> and <code>sdn-licenses-available</code> .

Interoperability Among Framework Components

The term *interoperable* refers to environments where different versions of Genesys solutions, components, or options work together compatibly during the migration process.

Interoperability of Genesys products can occur at two levels of migration:

- **Interoperability at the suite-level** means combining different versions of solutions and options during the migration process.

Example: You can migrate to the Configuration Layer of Framework 7.5 while still using 6.5 components. See *Genesys 8 Interoperability Guide* for information on the compatibility of Genesys products with various Configuration Layer Environments; Interoperability of Reporting Templates and Solutions; and *Gplus* Adapters Interoperability.

- **Interoperability at the solution-specific level** means combining different versions of the components of a particular solution while upgrading them sequentially during the migration process.

Example: The mixture of components may include executables, applications, routing strategies, scripts, and data that comprise a particular solution.

As you upgrade each of the components in sequence, you will need to know if it is backward-compatible with the other components of your environment.

T-Server Interoperability

Hot or Warm Standby Mode

If you are running your T-Servers in either hot or warm standby mode, then the primary and backup T-Servers must both be of the same release family (although within the family there can be minor-release differences).

Single-Site Environment

In single-site environments, if you are using a hot standby configuration that requires HA Proxy, you must use the same release family for both your T-Server and its corresponding HA Proxy, with some exceptions noted.

Multi-Site Environment

Multi-site deployments of T-Server allow for interoperability of T-Server versions between sites. You can migrate one T-Server (and its HA Proxy, if appropriate) without migrating your other T-Servers. Use this concept to keep your production system up during migration. You will need to route work through alternate T-Servers while migrating a given T-Server to the current release.

Note: Starting with release 7.6, T-Server for Nortel Communication Server 2000/2100 supports 7.5 HA Proxy.

Additional Information about Migration

The following information is also pertinent to the migration of T-Server 8.0.

- Be sure to review the specific issues that relate to your T-Server, especially with respect to changes in configuration options. (See Chapter 21, “Changes in T-Server and HA Proxy Configuration Options,” on [page 307](#) for details.)



Chapter

21

Changes in T-Server and HA Proxy Configuration Options

The chapter compares the changes for configuration options for T-Server 8.0 operation with earlier releases. In each case, details of the option change are given along with specific configuration instructions, when applicable. As with component configuration in Configuration Manager, the following configuration options are divided into sections.

The options listed here are cumulative from the 6.0 release of T-Server. Read through all the pertinent tables carefully to determine which options offer new or changed functionality for your new T-Server.

This chapter discusses the following topics:

- [Configuration Options Common to All T-Servers, page 307](#)
- [T-Server-Specific Configuration Options, page 318](#)

Complete information on each supported T-Server option for the current release is available in your specific *T-Server Deployment Guide*.

Configuration Options Common to All T-Servers

[Table 37](#) outlines the new and enhanced functionality of options in the various configuration sections for your new T-Server. The options listed in this table apply to any T-Server; the “T-Server Common Configuration Options” chapter of your specific *T-Server Deployment Guide* describes these options in detail.

As with the rest of the information in this chapter, it is assumed that you are migrating to the most recent release of T-Server. All version numbers in the following tables are for historical reference only.

Table 37: Changes to T-Server Common Configuration Options

Option Name	Type of Change	Occurred in Release #	Details
TServer Section			
port phone-file	See Details	6.0	These 5.1 options are no longer valid. You must configure all relevant configuration settings in the Configuration Database.
verbose log-file-name log-file-size log-remove-old-files log-check-interval log-buffering	See Details	6.0	These 5.1 options are no longer valid. Refer to Table 3, “Common Option Changes,” on page 100 for the replacement information.
link- <i>n</i> -name	See Details	6.5.2	The value of <i>n</i> cannot be zero.
log-trace-flags	New valid values	6.0	The +/-dev link value has been added.
		6.5.0	The following new values have been added: <ul style="list-style-type: none"> • +/-i scc • +/-passwd • +/-sw (reserved by Genesys Engineering) • +/-req (reserved by Genesys Engineering) • +/-callops (reserved by Genesys Engineering) • +/-conn (reserved by Genesys Engineering)
background-processing	New	6.1	
server-id	New default value	6.5.0	New default value: An integer equal to the Application DBID reported by Configuration Server. Old default value: 0
user-data-limit	New	7.0	
background-timeout	New	7.0.2	
merged-user-data	New	7.1	
ani-distribution	New	7.6	

Table 37: Changes to T-Server Common Configuration Options (Continued)

Option Name	Type of Change	Occurred in Release #	Details
compatibility-port	Obsolete	7.6	
dn-scope	New	8.0	
propagated-call-type	New	8.0	
License Section			
This section has been added in the 7.0 release. This section must be called <code>license</code> in the T-Server configuration.			
license-file	See Details	6.5.0	Prior to the 6.5 release of T-Server, this option was incorrectly listed as dynamic (changes take effect immediately). Any value change to this option only takes effect after T-Server is restarted.
		7.0	This option has been moved to the new License Section. Refer to the <i>Genesys Licensing Guide</i> for option description.
num-of-licenses	See Details	6.5.0	Prior to the 6.5 release of T-Server, the maximum value for this option was not documented. The maximum number of licenses that can be specified for this option is 9999.
		7.0	This option has been moved from the T-Server section to the license section.
num-sdn-licenses	New	7.0	
Agent-Reservation Section			
This section has been added in the 6.1 release. This section must be called <code>agent-reservation</code> .			
request-collection-time	New	6.1	
	New valid value	6.5.2	New valid value: A string value in the format described in “Timeout Value Format” on page 317 . Old valid value: Any integer

Table 37: Changes to T-Server Common Configuration Options (Continued)

Option Name	Type of Change	Occurred in Release #	Details
reservation-time	New	6.1	
	New valid value	6.5.2	New valid value: A string value in the format described in “Timeout Value Format” on page 317 . Old valid value: Any integer
reject-subsequent-request	New	6.5.2	
collect-lower-priority-requests	New	8.0	
Multi-Site Support Section This section must be called extrouter.			
cast-type	New valid values	6.1	The following valid values have been added: <ul style="list-style-type: none"> • direct-notoken • direct-ani • direct-uuu • direct-digits • reroute • dnis-pool
	New default values	6.5.0	New default values: route, direct, reroute, direct-uuu, direct-notoken, direct-ani, dnis-pool, direct-digits Old default value: route
	Changes take effect	6.5.2	Support for dynamic changes has been clarified in the document. Changes take effect for the next request for remote service.
	New valid value	6.5.3	The pullback valid value has been added.
	New valid value	7.1	The route-IOU valid value has been added. An alias, route-nicotine, has been added to the route value.
	New valid value	7.2	The direct-network-called valid value has been added.

Table 37: Changes to T-Server Common Configuration Options (Continued)

Option Name	Type of Change	Occurred in Release #	Details
direct-digits-key	New	6.1	
	Changes take effect	6.5.2	Support for dynamic changes has been clarified in the document. Changes take effect for the next request for remote service.
register-attempts	New	6.0	
	Changes take effect	6.5.2	Support for dynamic changes has been clarified in the document. Changes take effect for the next registration.
register-tout	New default value	6.0	New default value: 2 Old default value: 60
	See Details	6.5.0	This option is now used only with the route type of routing.
	New valid value	6.5.2	New valid value: A string value in the format described in “Timeout Value Format” on page 317 . Old valid value: Any integer
	Changes take effect	6.5.2	Support for dynamic changes has been clarified in the document. Changes take effect for the next registration.
default-dn	See Details	6.5.0	This option can also be configured for the direct type of routing.
	Changes take effect	6.5.2	Support for dynamic changes has been clarified in the document. Changes take effect for the next request for remote service.
route-dn	Changes take effect	6.1	This option now supports dynamic changes.
dn-for-unexpected-calls	New	6.1	

Table 37: Changes to T-Server Common Configuration Options (Continued)

Option Name	Type of Change	Occurred in Release #	Details
reconnect-tout	New valid value	6.1	The timeout for reconnection can be specified as unlimited.
		6.5.2	New valid value: A string value in the format described in “Timeout Value Format” on page 317 . Old valid value: Any integer
	Changes take effect	6.5.2	Support for dynamic changes has been clarified in the document. Changes take effect for the next request for remote service.
request-tout	New default value	6.0	New default value: 20 Old default value: 10
	New valid value	6.5.2	New valid value: A string value in the format described in “Timeout Value Format” on page 317 . Old valid value: Any integer
	Changes take effect	6.5.2	Support for dynamic changes has been clarified in the document. Changes take effect for the next request for remote service.
timeout	New default value	6.0	New default value: 60 Old default value: 30
	New valid value	6.5.2	New valid value: A string value in the format described in “Timeout Value Format” on page 317 . Old valid value: Any integer
	Changes take effect	6.5.2	Support for dynamic changes has been clarified in the document. Changes take effect for the next request for remote service.
report-connid-changes	New	6.5.0	

Table 37: Changes to T-Server Common Configuration Options (Continued)

Option Name	Type of Change	Occurred in Release #	Details
use-data-from	New valid values	6.5.2	New valid values: active, original, consult-user-data (reserved for Genesys internal use). Old valid values: consult, main.
	New valid value	7.6	New option value, active-data-original-call. Note: For compatibility with the previous T-Server releases, you can use the values consult, main, and consult-user-data for this option. These are aliases for active, original, and current, respectively.
	New default value	8.0	New default value: current. Old default value: active.
cof-feature	New	6.0	
	New default value	6.5.0	New default value: false Old default value: no
	New valid values	6.5.0	New valid values: true, false Old valid values: yes, no
cof-ci-req-tout	New	6.0	
	New valid value	6.5.2	New valid value: A string value in the format described in “Timeout Value Format” on page 317 . Old valid value: Any integer
	Changes take effect	6.5.2	Support for dynamic changes has been clarified in the document. Changes take effect for the next COF operation.

Table 37: Changes to T-Server Common Configuration Options (Continued)

Option Name	Type of Change	Occurred in Release #	Details
cof-rci-tout	New	6.0	
	New valid value	6.5.2	New valid value: A string value in the format described in “Timeout Value Format” on page 317 . Old valid value: Any integer
	Changes take effect	6.5.2	Support for dynamic changes has been clarified in the document. Changes take effect for the next COF operation.
cof-ci-wait-all	New	7.1	
cof-ci-defer-delete	New	7.1	
cof-ci-defer-create	New	7.2	
event-propagation	New	6.1	
tcs-use	See Details	6.5.0	As supported in later releases of T-Server 5.1, Transfer Connect Service (TCS) is now supported through the reintroduction of this option.
tcs-queue	See Details	6.5.0	As supported in later releases of T-Server 5.1, Transfer Connect Service (TCS) is now supported through the reintroduction of this option.
local-node-id	New	6.1	This option applies only to the T-Server for Nortel Communications Server 2000/2100, formerly known as Nortel DMS-100.
	New default value	6.5.0	New default value: 0 Old default value: No default value
	New valid values	6.5.0	New valid value: 0 or any positive integer Old valid value: Any positive integer
resource-allocation-mode	New	6.5.3	
resource-load-maximum	New	6.5.3	

Table 37: Changes to T-Server Common Configuration Options (Continued)

Option Name	Type of Change	Occurred in Release #	Details
backup-type	See Details	See Details	Implemented in the 6.0 release, this option has been removed in the 6.1 release.
cof-queues	See Details	See Details	Implemented in the 6.0 release for T-Server for Meridian 1, this T-Server common option has been removed in the 6.5 release.
protocol addp-timeout addp-remote-timeout addp-trace	See Details	See Details	Implemented in the 6.0 release, these options have been removed in the 6.5.2 release.
match-call-once	New	7.1	
network-request-timeout	New	7.1	
use-implicit-access-numbers	New	7.2	
inbound-translator-<n>	New	7.2	
compound-dn-representation	New	8.0	
default-network-call-id-matching	See Details	7.2	This option is undocumented in previous versions.
epp-tout	New	8.0	
Transaction Rules Section			
This section has been added in the 7.2 release. The section name is specified by the <code>inbound-translator-<n></code> option.			
rule-<n>	New	7.2	
Backup-Synchronization Section			
This section has been added in the 6.1 release. This section must be called <code>backup-sync</code> . This section applies only to those T-Servers that support <code>hot standby</code> .			
protocol	New	6.1	

Table 37: Changes to T-Server Common Configuration Options (Continued)

Option Name	Type of Change	Occurred in Release #	Details
addp-timeout	New	6.1	
	New default value	6.5.2	New default value: 0 Old default value: 1
	New valid values	6.5.2	New default value: Any integer between 0-3600 Old default value: Any integer between 1-65535
addp-remote-timeout	New	6.1	
	New default value	6.5.2	New default value: 0 Old default value: 1
	New valid value		New default value: Any integer between 0-3600 Old default value: Any integer between 1-65535
addp-trace	New	6.1	
sync-reconnect-tout	New	6.1	
	New valid value	6.5.2	New valid value: A string value in the format described in “Timeout Value Format” on page 317 . Old valid value: Any integer
network-provided-address	New	7.1	
	Obsolete	7.6	
Call-Cleanup Section			
This section has been added in the initial 7.1 release. This section must be called call-cleanup.			
notify-idle-tout	New	7.1	
cleanup-idle-tout	New	7.1	
periodic-check-tout	New	7.1	

Table 37: Changes to T-Server Common Configuration Options (Continued)

Option Name	Type of Change	Occurred in Release #	Details
Security Section			
This section has been added in the initial 7.5 release. This section must be called <code>Security</code> .			
<code>certificate</code>	New	7.5	
<code>certificate-key</code>	New	7.5	
<code>trusted-ca</code>	New	7.5	

T-Server also supports common log options. See Table 3, “Common Option Changes,” on [page 100](#) for details.

Timeout Value Format

This section of the document describes the values to use for those T-Server common options that set various time-outs. The current format allows you to use fractional values and various time units for timeout settings.

For timeout-related options, you can specify any value that represents a time interval as long as it is specified in either of the following formats:

```
[[[hours:]minutes:]seconds][.msecs]
```

or

```
[hours ruminates min][seconds sec][msecs msec]
```

Where a time unit name in *italic* (such as *hours*) is to be replaced by an integer value for this time unit.

Integer values with no measuring units are still supported for compatibility with previous releases of T-Server. When you do not specify any measuring units, the same units apply as those of the default value. For example, if the default value equals `60 sec`, specifying the value of `30` sets the option to 30 seconds.

Example 1 The following settings result in a value of 1 second and 250 milliseconds:

```
sync-reconnect-tout = 1.25
```

```
sync-reconnect-tout = 1 sec 250 msec
```

Example 2 The following settings result in a value of 1 minute and 30 seconds:

```
timeout = 1:30
```

```
timeout = 1 min 30 sec
```

T-Server-Specific Configuration Options

Refer to the following tables to find specific information relating to option changes that may have occurred between the most recent 8.0 release of T-Server and your earlier release. Complete information on each supported T-Server option for the current release is available in your specific *T-Server Deployment Guide*.

Note: Names of T-Servers have changed over time both to reflect their modified functionality and to accommodate the changes in names of switches. The names for T-Servers in this chapter reflect the most recent names for those products.

Changes to Options for HA Proxy

If an HA Proxy component has any changes to its configuration options, those changes are noted after the section corresponding to the T-Server with which it is associated.

Changes to T-Server-Specific Configuration Options

The following T-Servers have important differences in configurations from earlier releases (see the accompanying tables for details).

- [T-Server for Alcatel A4200/OXO, page 320](#)
- [T-Server for Alcatel A4400/OXE, page 323](#)
- [T-Server for Aspect ACD, page 330](#)
- [T-Server for Avaya Communication Manager, page 333](#)
- [HA Proxy for Avaya DEFINITY ECS \(MV\), page 338](#)
- [T-Server for Avaya INDeX, page 338](#)
- [T-Server for Avaya TSAPI, page 343](#)
- [T-Server for Cisco Unified Communications Manager, page 344](#)
- [T-Server for DataVoice Dharma, page 347](#)
- [T-Server for Digitro AXS/20, page 349](#)
- [T-Server for Ericsson MD110, page 351](#)
- [T-Server for Fujitsu F9600, page 359](#)
- [T-Server for EADS Intecom M6880, page 361](#)
- [T-Server for EADS Telecom M6500 Succession, page 363](#)
- [T-Server for Huawei C&C08, page 367](#)
- [T-Server for Meridian 1, page 368](#)
- [T-Server for Mitel SX-2000/MN-3300, page 369](#)
- [T-Server for NEC NEAX/APEX, page 374](#)

- T-Server for Nortel Communication Server 1000 with SCCS/MLS, page 376
- T-Server for Nortel Communication Server 2000/2100, page 380
- HA Proxy for Nortel Communication Server 2000/2100, page 386
- T-Server for Philips Sopho iS3000, page 386
- HA Proxy for Philips Sopho iS3000, page 388
- T-Server for Rockwell Spectrum, page 389
- T-Server for Siemens Hicom 300/HiPath 4000 CSTA I, page 391
- T-Server for Siemens HiPath DX, page 397
- T-Server for Siemens HiPath 3000 CSTA III, page 400
- T-Server for Siemens HiPath 4000 CSTA III, page 401
- T-Server for Meridian 1, page 368
- T-Server for Tadiran Coral, page 406
- T-Server for Teltronics 20-20, page 408
- T-Server for Tenovis Integral 33/55, page 409

Changes to Network T-Servers-Specific Options

- Network T-Server for AT&T, page 411
- Network T-Server for Concert, page 411
- Network T-Server for CRSP, page 415
- Network T-Server for DTAG, page 416
- Network T-Server for GenSpec, page 417
- Network T-Server for ISCP, page 425
- Network T-Server for NGSN, page 426
- Network T-Server for OPSI, page 427
- Network T-Server for SR3511, page 427

Network T-Servers with No Configuration Option Changes

- Network T-Server for MCI
- Network T-Server for Sprint

T-Server for Alcatel A4200/OXO

Prior to release 7.1, this product was known as T-Server for Alcatel A4200.

[Table 38](#) shows the modifications made to switch-specific options for T-Server for Alcatel A4200/OXO when migrating to its latest release.

Table 38: Option Modifications in T-Server for Alcatel A4200/OXO

Option Name	Type of Change	Occurred in Release #	Details
Application-Level Options > TServer Section			
inbound-bsns-calls	New	6.5.1	
outbound-bsns-calls	New	6.5.1	
legal-guard-time	New	6.5.1	
wrap-up-time	New	6.5.1	
timed-cwk-in-idle	New	6.5.1	
cwk-in-idle-force-ready	New	6.5.1	
agent-strict-id	New	6.5.2	
supervised-route-timeout	New	6.5.2	
shutdown-limit	Removed	6.5.2	
agent-no-answer-timeout	New	6.5.2	
	Modified	7.0	
agent-no-answer-overflow	New	6.5.2	
	Modified	7.0	
agent-no-answer-action	New	6.5.2	
	Modified	7.0	
notrdy-bsns-cl-force-rdy	New	7.0	
	Removed	7.6	
prd-dist-call-ans-time	New	7.0	
max-pred-req-delay	New	7.0	
extn-no-answer-timeout	New	7.0	
extn-no-answer-overflow	New	7.0	

Table 38: Option Modifications in T-Server for Alcatel A4200/OXO (Continued)

Option Name	Type of Change	Occurred in Release #	Details
posn-no-answer-timeout	New	7.0	
posn-no-answer-overflow	New	7.0	
inherit-bsns-type	New	7.0.2	
retain-call-tout	Modified	7.6	Renamed from <code>retain-call-tmout</code> and moved from CTI-Link section.
unknown-xfer-merge-udata	New	7.6	
untimed-wrap-up-value	New	7.6	
internal-bsns-calls	New	7.6	
unknown-bsns-calls	New	7.6	
wrap-up-threshold	New	7.6	
inherit-bsns-type	New	7.6	
backwds-compat-acw-behavior	New	7.6	
emulated-login-state	New	7.6	
sync-emu-agent	New	7.6	
agent-group	New	7.6	
timed-acw-in-idle	Modified	7.6	Renamed from <code>timed-cwk-in-idle</code> .
acw-in-idle-force-ready	Modified	7.6	Renamed from <code>cwk-in-idle-force-ready</code> .
nas-private	New	7.6	
recall-no-answer-timeout	New	7.6	
nas-indication	New	7.6	
accept-dn-type	New	7.6	
default-dn-type	New	7.6	
dn-del-mode	New	7.6	
callback-dn	New	7.6	

Table 38: Option Modifications in T-Server for Alcatel A4200/OXO (Continued)

Option Name	Type of Change	Occurred in Release #	Details
correct-connid	New	7.6	
correct-rqid	New	7.6	
convert-otherdn	New	7.6	
dn-for-undesired-calls	New	7.6	
auto-xfer-dly	New	7.6	
onhook-dly	New	7.6	
consult-supervised-rt	Modified	7.6	Default value changed to <code>false</code> .
Application-Level Options > Switch-Specific Type Section (New in 7.6)			
extension	New	7.6	
Application-Level Options > CTI-Link Section			
reroute-gap	Removed	6.5.2	
reg-interval	New	6.5.2	
	Modified	7.0.2	Default value changed from 60 to 0.
	Removed	7.6	
expire-call-tmout	Removed	7.0.2	
call-rq-gap	New	7.0.2	
hostname host	New	7.0.2	Name changed to <code>hostname</code> . You can still use the previous name as an alias.
reg-delay	New	7.6	
reg-silent	New	7.6	
rq-gap	New	7.6	
restart-cleanup-limit	New	7.6	
restart-cleanup-dly	New	7.6	
quiet-cleanup	New	7.6	
quiet-startup	New	7.6	

Table 38: Option Modifications in T-Server for Alcatel A4200/OXO (Continued)

Option Name	Type of Change	Occurred in Release #	Details
rq-expire-tout	New	7.6	
	Modified	7.6	Renamed from rq-expire-tmout.
ha-sync-dly-lnk-conn	New	7.6	
kpl-interval	New	7.6	
kpl-tolerance	New	7.6	
kpl-loss-rate	New	7.6	
port	Modified	7.6	Default value changed from no default value to 2555.
Agent Login-Level and DN-Level Options > TServer Section			
no-answer-timeout	New	7.0	
no-answer-overflow	New	7.0	
no-answer-action	New	7.0	

T-Server for Alcatel A4400/OXE

Prior to release 7.1, this product was known as T-Server for Alcatel A4400.

[Table 39](#) shows the modifications made to switch-specific options for T-Server for Alcatel A4400/OXE when migrating to its latest release.

Table 39: Option Modifications in T-Server for Alcatel A4400/OXE

Option Name	Type of Change	Occurred in Release #	Details
Application-Level Options > TServer Section			
rsi-remain-retry	New	6.1	
rsi-reroute-auth	New	6.1	
ack-on-noevt	New	6.1	
agent-state-evt-tout	New	6.1	
tserver-date-time	Removed	6.5.1	
update-pbx-time-interval	Removed	6.5.1	

Table 39: Option Modifications in T-Server for Alcatel A4400/OXE (Continued)

Option Name	Type of Change	Occurred in Release #	Details
sstep-transfer-enable	Removed	6.5.1	
release-busy-dest	Removed	6.5.1	
snapshot-on-start	New	6.5.1	
timed-cwk-in-idle	New	6.5.3	
cwk-in-idle-force-ready	New	6.5.3	
auto-transfer-to-route	New default value	6.5.3	New value: true Old value: false
rsi-reroute-auth	New default value	6.5.3	New value: 63
legal-guard-acw	New	6.5.3	
supervised-route	New	6.5.3	
agent-smart-monitor	New valid value	6.5.3	New value: strict
backup-routepoint	Removed	6.5.3	
agent-no-answer-timeout	New	7.0	
agent-no-answer-overflow	New	7.0	
agent-no-answer-action	New	7.0	
extn-no-answer-timeout	New	7.0	
extn-no-answer-overflow	New	7.0	
posn-no-answer-timeout	New	7.0	
posn-no-answer-overflow	New	7.0	
prd-dist-call-ans-time	New	7.0	Functionality changed.
notrdy-bsns-cl-force-rdy	New	7.0	
	Removed	8.0	
max-pred-req-delay	New	7.0	
pcm-port-rls-dly	New	7.0.1	

Table 39: Option Modifications in T-Server for Alcatel A4400/OXE (Continued)

Option Name	Type of Change	Occurred in Release #	Details
min-xfer-init-dly	New	7.0.1	
min-xfer-complete-dly	New	7.0.1	
auto-originate	Modified	7.0.2	Functionality changed.
trace	Removed	7.0.2	
allow-20-announ	New	7.0.2	
clean-failed-to-pilot	New	7.0.2	
snapshot-interval	New	7.0.2	
dtmf-tone-pause-duration	Removed	7.0.2	
dtmf-tone-duration	Removed	7.0.2	
min-route-dly	New	7.0.2	
correct-rqid	New	7.0.2	
correct-connid	New	7.0.2	
rsi-xfer-tout	New	7.0.2	
rsi-report-xfer	New	7.0.2	
max-outstanding	New	7.0.2	
	See Details	7.1	Moved from the T-Server section to the Link-Control section.
log-con-conf	Removed	7.0.2	
rq-gap	New	7.0.2	
	See Details	7.1	Moved from the T-Server section to the Link-Control section.
convert-otherdn	New	7.1	
callback-dn	New	7.1	
accode-privateservice	New	7.1	
accode-data	New	7.1	

Table 39: Option Modifications in T-Server for Alcatel A4400/OXE (Continued)

Option Name	Type of Change	Occurred in Release #	Details
accode-name	New	7.1	
	See Details	8.0	Default value changed from GCTI_CSTA_ACCOUNT_INFO to AccountCode in 8.0
supervised-route-timeout route-no-answer-timeout	Modified	7.1	Renamed from route-no-answer-timeout to supervised-route-timeout. You can still use the previous name as an alias.
agent-strict-id	New	7.1	
	See Details	8.0	New value passwd added.
failed-call-rls-dly	New	7.1	
inbound-bsns-calls	Modified	7.1	Functionality extended to include real agents.
outbound-bsns-calls	Modified	7.1	Functionality extended to include real agents.
wrap-up-time agent-pause-time	Modified	7.1	Renamed from agent-pause-time to wrap-up-time. You can still use the previous name as an alias.
agent-substitute	Modified	7.1	Default value changed to true.
link- <i>n</i> -name	Modified	7.1	Default value changed to link-tcp.
inherit-bsns-type	New	7.1	
internal-bsns-calls	New	7.1	
unknown-bsns-calls	New	7.1	
nas-private	New	7.1	
switchover-grace-tout	New	7.1	
	Removed	8.0	
switchover-bck-compat	New	7.1	
	Removed	8.0	
emu-redir-accode	New	7.1	

Table 39: Option Modifications in T-Server for Alcatel A4400/OXE (Continued)

Option Name	Type of Change	Occurred in Release #	Details
emu-redir-enable	New	7.1	
emu-redir-handover-tout	New	7.1	
snapshot-mon-opt	New	7.2	
	Removed	8.0	
use-rsi-consult	New	7.2	
unknown-xfer-merge-udata	New	7.2	
legal-guard-reason	New	7.2	
extdn-bck-compat	New	7.5	
	Removed	8.0	
force-long-eqid	New	7.5	
	See Details	8.0	Moved to the Link-control section.
retain-call-tout	See Details	8.0	Moved to the Tserver section.
clid-withheld-name	New	8.0	
agent-group	New	8.0	
preassign-agent-compat	New	8.0	
rel-cons-reconnect	New	8.0	
dn-for-undesired-calls	New	8.0	
untimed-wrap-up-value	New	8.0	
wrap-up-threshold	New	8.0	
timed-acw-in-idle	New	8.0	
acw-in-idle-force-ready	New	8.0	
backwds-compat-acw-behavior	New	8.0	
override-switch-acw	New	8.0	
sync-emu-acw	New	8.0	

Table 39: Option Modifications in T-Server for Alcatel A4400/OXE (Continued)

Option Name	Type of Change	Occurred in Release #	Details
nas-indication	New	8.0	
accept-dn-type	New	8.0	
default-dn-type	New	8.0	
dn-del-mode	New	8.0	
emulate-login	New	8.0	
emulated-login-state	New	8.0	
agent-only-private-calls	New	8.0	
agent-logout-on-unreg	New	8.0	
agent-logout-reassoc	New	8.0	
agent-emu-login-on-call	New	8.0	
call-type-by-dn	New	8.0	
releasing-party-report	New	8.0	
route-failure-alarm-high-wm	New	8.0	
route-failure-alarm-low-wm	New	8.0	
rsi-bypass-fwd-dnd	New	8.0	
super-queue	Removed	8.0	
max-ext-xfer-dly	New	7.6	
	Removed	8.0	
Application-Level Options > Switch-Specific Section (new in 8.0)			
extension	New	8.0	
acd-position	New	8.0	
routing-point	New	8.0	
Agent Login-Level and DN-Level Options > TServer Section			
no-answer-action	New	7.0	
no-answer-timeout	New	7.0	

Table 39: Option Modifications in T-Server for Alcatel A4400/OXE (Continued)

Option Name	Type of Change	Occurred in Release #	Details
no-answer-overflow	New	7.0	
dn-for-undesired-calls	New	7.1	
Application-Level Options > Link-Control Section			
This section has been added in the initial 7.1 release. This section must be called <code>link-control</code> .			
rq-gap	See Details	7.1	Moved from the TServer section to the <code>link-control</code> section.
expire-call-tout	New	7.1	
	Removed	8.0	
full-linktrace	New	7.1	
	Removed	8.0	
ha-sync-dly-lnk-conn	New	7.1	
rq-expire-tout	New	7.1	
	See Details	7.5	Default and valid values changed.
	See Details	8.0	Default value changed from <code>90000</code> to <code>10000</code> .
restart-period	New	7.1	
restart-cleanup-limit	New	7.1	
	See Details	8.0	Default value changed from <code>0</code> to <code>10</code> .
restart-cleanup-dly	New	7.1	
quiet-cleanup	New	7.1	
quiet-startup	New	7.1	
max-outstanding	See Details	7.1	Moved from the TServer section to the <code>link-control</code> section.
retain-call-tout	New	7.5	
port	See Details	7.1	Default value changed to <code>2555</code> . Previously there was no default value.
reg-delay	New	8.0	

Table 39: Option Modifications in T-Server for Alcatel A4400/OXE (Continued)

Option Name	Type of Change	Occurred in Release #	Details
reg-silent	New	8.0	
kpl-interval	New	8.0	
kpl-tolerance	New	8.0	
kpl-loss-rate	New	8.0	
call-rq-gap	New	8.0	
link-alarm-high	New	8.0	
link-alarm-low	New	8.0	
use-link-bandwidth	New	8.0	
rq-conflict-check	New	8.0	
device-rq-gap	New	8.0	

Note: When configuring the 8.0 T-Server, do not delete previously configured pre-8.0 options in the T-Server Application object. The presence of obsolete configuration options in the T-Server Application object does not affect the operation of the 8.0 T-Server.

T-Server for Aspect ACD

The high-availability deployment possibilities for this T-Server have gone through a number of modifications. It is important that you refer to your specific *T-Server 8.0 Deployment Guide* for this T-Server for details if you are migrating from or migrating to a high-availability deployment.

[Table 40](#) shows the modifications made to switch-specific options for T-Server for Aspect ACD when migrating to its latest release.

Table 40: Option Modifications in T-Server for Aspect ACD

Option Name	Type of Change	Occurred in Release #	Details
Application-Level Options > TServer Section			
ams-delay	See Details		Omitted previously in error.
answer-mode	See Details		Omitted previously in error.

Table 40: Option Modifications in T-Server for Aspect ACD (Continued)

Option Name	Type of Change	Occurred in Release #	Details
rna-timeout	See Details		Omitted previously in error.
link-1-name	New	6.5.3	Valid value: CS4-Link (Identifies name of section containing connection information about the Contact Server, version 4.)
link- <i>n</i> -name	New	6.5.3	
	New default value	7.0	New default value: link-tcp Old default value: empty string
deliver-data-variables	Previously undocumented values	7.0	Undocumented valid values: ringing and established
deliver-track-data	Previously undocumented values	7.0	Undocumented valid values: in-user-data and user-data
route-call-method	New value	7.0	New valid value: CIMR-and-CCR
agent-acw-predict	New	7.0	
password-separator	Removed	7.0	
	Re-introduced	7.0.2	
primary-port	New default value	7.0	Default value: -1 Functionality changed from 6.5.3 onwards with removal of HA Proxy.
use-track-id	New	7.0.1	
use-dndoff	New	7.0.1	
send-rls-on-acw	New	7.0.1	
	Modified	7.0.2	New value: omit-pkr
walk-away-bck-compat	New	7.0.2	Default value: link-tcp
second-call-consult	New	7.0.2	
correct-connid	New	7.0.2	
correct-rqid	New	7.0.2	

Table 40: Option Modifications in T-Server for Aspect ACD (Continued)

Option Name	Type of Change	Occurred in Release #	Details
use-hook-evt	New	7.0.2	
convert-otherdn	New	7.1	
poll-dn-tout	New	7.1	
convert-otherdn	New	7.1	
poll-dn-tout	New	7.1	
route-uses-ctimr	New	7.2	
rtend-subtype	New	7.2	
rtabrt-subtype	New	7.5	
route-uses-ctimr	See Details	7.6	Default value changed to false.
station-svc-evt	See Details	7.6	Default value changed to no.
releasing-party-report	New	8.0	
route-failure-alarm-high-wm	New	8.0	
route-failure-alarm-low-wm	New	8.0	
route-failure-alarm-period	New	8.0	
Application-Level Options > Link-Control Section			
link-alarm-high	New	8.0	
link-alarm-low	New	8.0	
use-link-bandwidth	New	8.0	
Application-Level Options > CTI-Link Section			
link-id	New	6.5.2	
	Removed	8.0	
host	New	6.5.3	
port	New	6.5.3	

Table 40: Option Modifications in T-Server for Aspect ACD (Continued)

Option Name	Type of Change	Occurred in Release #	Details
protocol	New	6.5.3	
cs-configuration	New	6.5.3	
kpl-interval	New	7.1	
kpl-tolerance	New	7.1	
ha-sync-dly-lnk-conn	New	7.1	
restart-period	New	7.2	
restart-cleanup-dly	New	7.2	
restart-cleanup-limit	New	7.2	
quiet-startup	New	7.2	
quiet-cleanup	New	7.2	
All Options			
Dynamic reconfiguration of options has been implemented in 7.0.202. Any exceptions are documented.			

T-Server for Avaya Communication Manager

Over the course of its previous releases, the T-Server name has changed for various reasons, including, but not limited to, changes in vendor name or in Genesys policy. The former names include:

- T-Server for Lucent DEFINITY G3.
- T-Server for Avaya DEFINITY ECS (G3).
- T-Server for Avaya DEFINITY ECS (MV).

The current name is T-Server for Avaya Communication Manager.

[Table 41](#) shows the modifications made to switch-specific options for T-Server for Avaya Communication Manager, when migrating to its latest release.

Table 41: Option Modifications in T-Server for Avaya Communication Manager

Option Name	Type of Change	Occurred in Release #	Details
Application-Level Options > TServer Section			
delay-event-link-connected	New	6.5.2	
	New default value	7.0	New value: true Old value: false
	Removed	7.5	
merge-consult-data	New valid values	6.5.2	New valid values: false, orig-prio, consult-prio Old valid values: false, orig-prio, consult-prio, copy-consult
	Obsolete	7.1	Use the T-Server common option merged-user-data instead. You can still use merge-consult-data as an alias.
log-trace-flags (specific to this T-Server)	New default and valid values	6.5.2	New default value: +asa i_dump New valid values: +/-asa i_dump
	See Details	7.5	Documented incorrectly. The correct default value for this option is -qass.
override-incorrect-calltype	New	6.5.3	
	Removed	7.5	
ts-tp-enabled	New	6.5.3	
ts-tp-heartbeat-timer	New	6.5.3	
ts-tp-heartbeat-timout	New	6.5.3	
follow-calls	New	6.5.3	
preserve-collected-digits	New valid value	6.5.3	New value: accumulate
second-call-as-consult	New	6.5.3	
soft-login-support	New	7.0	

Table 41: Option Modifications in T-Server for Avaya Communication Manager (Continued)

Option Name	Type of Change	Occurred in Release #	Details
soft-wrap-up-time	New	7.0	
disable-digits-collection	New default value	7.0	New value: true Old value: false
max-registration-per-sec	Removed	7.0.2	Replaced with bandwidth-startup.
bandwidth	New	7.0.1	
	Removed	7.0.2	Replaced with use-link-bandwidth-startup.
bandwidth-startup-reg	New	7.0.1	
	Removed	7.0.2	Replaced with use-link-bandwidth-startup.
bandwidth-startup-query	New	7.0.1	
	Removed	7.0.2	Replaced with use-link-bandwidth-startup.
use-link-bandwidth	New	7.0.2	
	Modified	7.5	Option functionality has been modified.
	Modified	8.0	New range of valid values: 0-3000
use-link-bandwidth-startup	New	7.0.2	Replaces bandwidth, bandwidth-startup-reg, and bandwidth-startup-query.
	Obsolete	7.5	Still available for backward compatibility.
	Modified	8.0	New range of valid values: 0-3000
use-link-bandwidth-backup	New	7.6	
	Modified	8.0	New range of valid values: 0-3000
query-on-timer	New	7.0.2	
query-agent-work-mode	New valid value	7.0.2	New value on-timer added.

Table 41: Option Modifications in T-Server for Avaya Communication Manager (Continued)

Option Name	Type of Change	Occurred in Release #	Details
enable-query-on-timer-aux	New	7.0.2	
	Modified	7.5	This option is for backward compatibility of the enable-query-on-timer option.
enable-query-on-timer	See Details	7.5	This option name replaces enable-query-on-timer-aux.
msec-wait-for-ack	New default value	7.0.1	New value: 12000 Old value: 3000
high-water-mark	New	7.0.1	
	Modified	8.0	Minimum value changed to 10.
use-old-fwd-key	New	7.1	
enable-ucid-swap	New default value	7.2	New value: true Old value: false
foreign-party-uses-dialed-num	New	7.2	
	Removed	7.5	
agent-no-answer-timeout	New	7.5	
agent-no-answer-action	New	7.5	
agent-no-answer-overflow	New	7.5	
query-on-timer-acw	New	7.5	
query-on-timer-auto-in	New	7.5	
query-on-timer-man-in	New	7.5	
num-of-host-crv	Removed	7.5	
broken-tp-calleded	Removed	7.5	
call-clear-timeout-sec	Removed	7.5	
translate-addr-by-type	Removed	7.5	
5ESS	Removed	7.5	

Table 41: Option Modifications in T-Server for Avaya Communication Manager (Continued)

Option Name	Type of Change	Occurred in Release #	Details
5E-agent-status	Removed	7.5	
ts-tp-enabled	See Details	7.5	Default value has been changed to true.
send-tcs-dtmf	New	7.5	
max-attempts-to-register	Modified	7.5	Option description changed.
set-otherdn-trunk-info	New	7.5	
create-addr-on-register	New	8.0	
interflow-as-dnis	New	8.0	
link-alarm-high	New	8.0	
route-failure-alarm-high-wm	New	8.0	
route-failure-alarm-low-wm	New	8.0	
route-failure-alarm-period	New	8.0	
update-button-info	New	8.0	
use-auto-dial	New	8.0	
out-of-service-retry-interval	New	8.0	
Application-Level Options > CTI-Link Section			
link-type	New	8.0	
Application-Level Options > CTI-Link Section for DMCC			
hostname	New	8.0	
link-type	New	8.0	
password	New	8.0	
port	New	8.0	
session-duration	New	8.0	
switch-name	New	8.0	

Table 41: Option Modifications in T-Server for Avaya Communication Manager (Continued)

Option Name	Type of Change	Occurred in Release #	Details
username	New	8.0	
Application-Level Options > Query-Agent-State Section			
This section has been added in the 7.0.2 release. This section must be called query-agent-state.			
enable-query-on-timer-aux	New	7.0.2	
query-on-timer-AUX<X>	New	7.0.2	

HA Proxy for Avaya DEFINITY ECS (MV)

Prior to release 7.1, this product was known as HA Proxy for Avaya DEFINITY ECS (G3) and even prior to that, as HA Proxy for Lucent DEFINITY G3 ECS.

No configuration options changed between release 6.x and 7.0.

Note: Starting with release 7.1, HA Proxy for Avaya Communication Manager is no longer supported.

T-Server for Avaya INDeX

Table 42 shows the modifications made to switch-specific options for T-Server for Avaya INDeX when migrating to its latest release.

Table 42: Option Modifications in T-Server for Avaya INDeX

Option Name	Type of Change	Occurred in Release #	Details
Application-Level Options > TServer Section			
shutdown-limit	Removed	6.5.2	
supervised-route-timeout	New default value	7.0	New default value: none Old default value: 0
	New default value	6.5.3	New default value: 0 (in 6.5.3) Old default value: 5
	New	6.5.2	
prd-dist-call-ans-time	New	6.5.3	

Table 42: Option Modifications in T-Server for Avaya INDeX (Continued)

Option Name	Type of Change	Occurred in Release #	Details
inbound-bsns-calls	New	6.5.3	
outbound-bsns-calls	New	6.5.3	
legal-guard-time	New	6.5.3	
wrap-up-time	New	6.5.3	
timed-cwk-in-idle	New	6.5.3	
cwk-in-idle-force-ready	New	6.5.3	
agent-strict-id	New	6.5.3	
agent-no-answer-timeout	Modified	7.0	
	New	6.5.2	
agent-no-answer-overflow	Modified	7.0	
	New	6.5.2	
agent-no-answer-action	Modified	7.0	
	New	6.5.2	
notrdy-bsns-cl-force-rdy	New	7.0	
	Removed	7.6	
max-pred-req-delay	New	7.0	
extn-no-answer-timeout	New	7.0	
extn-no-answer-overflow	New	7.0	
posn-no-answer-timeout	New	7.0	
posn-no-answer-overflow	New	7.0	
inherit-bsns-type	New	7.0.2	
use-redirect	New	7.0.2	
accept-err-sstep	New	7.0.2	
unknown-xfer-merge-udata	New	7.6	
clid-withheld-name	New	7.6	

Table 42: Option Modifications in T-Server for Avaya INDeX (Continued)

Option Name	Type of Change	Occurred in Release #	Details
agent-group	New	7.6	
wrap-up-threshold	New	7.6	
untimed-wrap-up-value	New	7.6	
internal-bsns-calls	New	7.6	
unknown-bsns-calls	New	7.6	
wrap-up-threshold	New	7.6	
inherit-bsns-type	New	7.6	
backwds-compat-acw-behavior	New	7.6	
override-switch-acw	New	7.6	
nas-private	New	7.6	
recall-no-answer-timeout	New	7.6	
nas-indication	New	7.6	
accept-dn-type	New	7.6	
nas-private	New	7.6	
recall-no-answer-timeout	New	7.6	
nas-indication	New	7.6	
accept-dn-type	New	7.6	
default-dn-type	New	7.6	
dn-del-mode	New	7.6	
emulate-login	New	7.6	
emulated-login-state	New	7.6	
sync-emu-agent	New	7.6	
retain-call-tout	New	7.6	
	Modified	7.6	Renamed from <code>retain-call-tmout</code> and moved to the TServer section.

Table 42: Option Modifications in T-Server for Avaya INDeX (Continued)

Option Name	Type of Change	Occurred in Release #	Details
emu-sstr	New	7.6	
cleanup-reserved	New	7.6	
dial-separator	New	7.6	
acw-in-idle-force-ready	Modified	7.6	Renamed from <code>cwk-in-idle-force-ready</code> .
timed-acw-in-idle	Modified	7.6	Renamed from <code>timed-cwk-in-idle</code> .
supervised-route-timeout	Modified	7.6	Default value changed to 5.
consult-supervised-rt	Modified	7.6	Default value changed to <code>false</code> .
correct-connid	New	7.6	
correct-rqid	New	7.6	
convert-otherdn	New	7.6	
dn-for-undesired-calls	New	7.6	
consult-supervised-rt	Modified	7.6	Default value changed to <code>false</code> .
Application-Level Options > Switch-Specific Type Section (New in 7.6)			
acd-queue	New	7.6	
Application-Level Options > cof-matching-trunks Section (New in 7.6.001.00)			
trunk-match- <i>n</i>	New	7.6	
Application-Level Options > trunk-match-<<i>n</i>> Section (New in 7.6.001.00)			
trunk-match- <i>n</i>	New	7.6	
location	New	7.6	
Application-Level Options > Link-Control Section			
reroute-gap	Removed	6.5.2.	
backup-mode	New	6.5.2	
	Removed	6.5.3	
max-outstanding	New	6.5.3	

Table 42: Option Modifications in T-Server for Avaya INDeX (Continued)

Option Name	Type of Change	Occurred in Release #	Details
rq-gap	New	6.5.3	
rq-expire-tmout	New default value	6.5.3	New value: 10000 Old value: 5000
access-manager	Removed	7.0	
kpl-interval	New	6.5.2	
	Modified	7.0.2	New default value: 60 Old default value: 10
	Modified	7.6	Default value changed to 10.
kpl-tolerance	New	6.5.2	
	Modified	7.0.2	New default value: 2 Old default value: 3
	Modified	7.6	Default value changed to 3.
call-rq-gap	New	7.0.2	
reg-interval	New	7.0.2	
reg-delay	New	7.6	
reg-silent	New	7.6	
restart-cleanup-limit	New	7.6	
restart-cleanup-dly	New	7.6	
quiet-cleanup	New	7.6	
quiet-startup	New	7.6	
kpl-loss-rate	New	7.6	
ha-sync-dly-lnk-con	New	7.6	
rq-expire-tout	Modified	7.6	Renamed from rq-expire-tmout.
Agent Login-Level and DN-Level Options > TServer Section			
no-answer-timeout	New	7.0	

Table 42: Option Modifications in T-Server for Avaya INDeX (Continued)

Option Name	Type of Change	Occurred in Release #	Details
no-answer-overflow	New	7.0	
no-answer-action	New	7.0	

T-Server for Avaya TSAPI

Table 43 shows the modifications made to switch-specific options for T-Server for Avaya TSAPI when migrating to its latest release.

Table 43: Option Modifications in T-Server for Avaya TSAPI

Option Name	Type of Change	Occurred in Release #	Details
Application-Level Options > TServer Section			
create-addr-on-register	New	8.0	
high-water-mark	New	7.6	
link-alarm-high	New	8.0	
update-button-info	New	8.0	
use-auto-dial	New	8.0	
use-link-bandwidth	New	7.6	
	Modified	8.0	New range of valid values: 0-3000
use-link-bandwidth-backup	New	7.6	
	Modified	8.0	New range of valid values: 0-3000
Application-Level Options > CTI-Link Section for DMCC			
hostname	New	8.0	
link-type	New	8.0	
port	New	8.0	
password	New	8.0	
session-duration	New	8.0	
switch-name	New	8.0	

Table 43: Option Modifications in T-Server for Avaya TSAPI (Continued)

Option Name	Type of Change	Occurred in Release #	Details
username	New	8.0	
Application-Level Options > Multi-Site Support Section			
default-network-call-id-matching	New	8.0	

T-Server for Cisco Unified Communications Manager

Prior to release 8.0, this product was known as T-Server for Cisco CallManager.

[Table 44](#) shows the modifications made to switch-specific options for T-Server for Cisco Unified Communications Manager when migrating to its latest release.

Table 44: Option Modifications in T-Server for Cisco Unified Communications Manager

Option Name	Type of Change	Occurred in Release #	Details
Application-Level Options > TServer Section			
multi-dn-login	New	6.5.3	
	Removed	7.5	
logout-on-out-of-service	New	7.0	
default-dn	See Details	7.0	New functionality. Provides the destination for calls that cannot be queued.
use-default-route	New	7.2	
audio-codec	Changes take effect	7.2	Changed to “After T-Server is restarted”
packet-size	Changes take effect	7.2	Changed to “After T-Server is restarted”
callmgr-autopickup-on	New	7.5	
logout-on-agent-disconnect	New	7.5	
logout-on-fwd	New	7.5	

Table 44: Option Modifications in T-Server for Cisco Unified Communications Manager (Continued)

Option Name	Type of Change	Occurred in Release #	Details
enable-pickup-jtapi-workaround	New	7.5	
enable-data-on-bridged	New	7.5	
wait-after-sm-conn-secs	Removed	7.5	
complete-rp-mutexfer-before-route	Removed	7.5	
agent-no-answer-action	New	7.5	
agent-no-answer-overflow	New	7.5	
agent-no-answer-timeout	New	7.5	
link- <i>n</i> -name	New	7.6	
ccm-host	Removed	8.0	
default-monitor-mode	New	8.0	
intrusion-enabled	New	8.0	
password	Removed	8.0	
record-only-business-calls	New	8.0	
recording-filename	New	8.0	
recording-filename-suffix	New	8.0	
user-login	Removed	8.0	
Application-Level Options > JTAPI Section			
JTAPI section	New section	6.5.3	
TServerTraceFileBase	New	8.0	
TServerTraceFileExt	New	8.0	
TServerTraceMaxFiles	New	8.0	
TServerTraceMaxFileSize	New	8.0	

Table 44: Option Modifications in T-Server for Cisco Unified Communications Manager (Continued)

Option Name	Type of Change	Occurred in Release #	Details
Application-Level Options > Global Group Section			
jvm-or-socket	New	7.2	
	See Details	7.6	The default value has changed to socket.
	Removed	8.0	
java-port	New	7.2	
	Removed	7.6	
enable-pickup-jtapi-workaround	New	7.5	
callmgr-autopickup-on	New	7.5	
enable-jtapi-keep-alive	New	7.5	
jtapi-keep-alive-timeout	New	7.5	
jtapi-keep-alive-retries	New	7.5	
Application-Level Options > Link Section			
ccm-host	New	7.6	
hostname	New	7.6	
password	New	7.6	
port	New	7.6	
protocol	New	7.6	
user-login	New	7.6	
DN-Level Options > TServer Section			
record	New	8.0	

T-Server for DataVoice Dharma

Table 45 shows the modifications made to switch-specific options for T-Server for DataVoice Dharma when migrating to its latest release.

Table 45: Option Modifications in T-Server for DataVoice Dharma

Option Name	Type of Change	Occurred in Release #	Details
Application-Level Options > TServer Section			
link-status-time	Removed	6.5.2	
route-rq-attempt	Removed	6.5.2	
shutdown-limit	Removed	6.5.2	
inbound-bsns-calls	New	6.5.3	Default value: false
outbound-bsns-calls	New	6.5.3	Default value: false
legal-guard-time	New	6.5.3	Default value: 0
wrap-up-time	New	6.5.3	Default value: 0
timed-cwk-in-idle	New	6.5.3	Default value: true
cwk-in-idle-force-ready	New	6.5.3	Default value: true
agent-strict-id	New	6.5.3	Default value: false
agent-no-answer-timeout	New	6.5.3	Default value: 15
	Modified	7.0	
agent-no-answer-overflow	New	6.5.3	No default value
	Modified	7.0	
agent-no-answer-action	New	6.5.3	Default value: none
	Modified	7.0	
notrdy-bsns-cl-force-rdy	New	7.0	Default value: false
extn-no-answer-timeout	New	7.0	Default value: 15
extn-no-answer-overflow	New	7.0	No default value
posn-no-answer-timeout	New	7.0	Default value: 15

Table 45: Option Modifications in T-Server for DataVoice Dharma (Continued)

Option Name	Type of Change	Occurred in Release #	Details
posn-no-answer-overflow	New	7.0	No default value
supervised-route-timeout	New	7.0	No default value
consult-supervised-rt	New	7.0	Default value: true
prd-dist-call-ans-time	New	7.0	Default value: 0
mute-xfer-dly	New	7.0.2	
max-pred-req-delay	New	7.0.2	
Application-Level Options > CTI-Link Section			
rq-gap	New	6.5.2	Default value: 10
kpl-interval	New	6.5.2	Default value: 10
retain-call-tmout	New	6.5.2	Default value: 15
reroute-gap	New	6.1	Default value: 300
	Removed	6.5.2	
expire-call-tmout	New	6.1	Default value: 60
	Removed	6.5.2	
kpl-tolerance	New	6.5.2	Default value: 3
switch-port	New default value	6.5.3	New value: 0 Old value: No default value
rq-expire-tmout	New default value	7.0	New value: 5000 Old value: 1000
	Modified	7.0.2	Default value changed from 10000 to 5000 in 7.0 and then changed back to 10000 in 7.0.2.
start-refid	New	7.0	Default value: 0
expire-call-tmout	Modified	7.0.2	Default value changed from 0 to 60.

Table 45: Option Modifications in T-Server for DataVoice Dharma (Continued)

Option Name	Type of Change	Occurred in Release #	Details
hostname switch-host	Modified	7.0.2	Renamed from switch-host to hostname. You can still use the previous name as an alias.
port switch-port	Modified	7.0.2	Rename from switch-port to port. You can still use the previous name as an alias.
Agent Login-Level and DN-Level Options > TServer Section			
no-answer-timeout	New	7.0	Default value: Same as value in corresponding global option
no-answer-overflow	New	7.0	No default value
no-answer-action	New	7.0	Default value: none

T-Server for Digitro AXS/20

[Table 46](#) shows the modifications made to switch-specific options for T-Server for Digitro AXS/20 when migrating to its latest release.

Table 46: Option Modifications in T-Server for Digitro AXS/20

Option Name	Type of Change	Occurred in Release #	Details
Application-Level Options > TServer Section			
emulate-login	New	7.5	
emulated-login-state	New	7.5	
agent-group	New	7.5	
sync-emu-agent	New	7.5	
untimed-wrap-up-value	New	7.5	
backwards-compat-acw-behavior	New	7.5	
override-switch-acw	New	7.5	
accept-dn-type	New	7.5	
default-dn-type	New	7.5	

Table 46: Option Modifications in T-Server for Digitro AXS/20 (Continued)

Option Name	Type of Change	Occurred in Release #	Details
dn-del-mode	New	7.5	
timed-cwk-in-idle timed-acw-in-idle	See Details	7.5	Renamed to <code>timed-acw-in-idle</code> . You can still use the old name as an alias.
cwk-in-idle-force-ready acw-in-idle-force-ready	See Details	7.5	Renamed to <code>acw-in-idle-force-ready</code> . You can still use the old name as an alias.
default-dialling-rule	New	7.5	
transit-call	New	7.5	
transit-request	New	7.5	
guard-transit-request	New	7.5	
Application-Level Options > Switch-Specific Type Section (New in 7.5)			
extension	New	7.5	
Application-Level Options > mk-feature-invoke-rules Section (New in 7.5)			
rule- <i>n</i>	New	7.5	
Application-Level Options > dialling-plan-rules Section (New in 7.5)			
ext-rule- <i>n</i>	New	7.5	
int-rule- <i>n</i>	New	7.5	
Application-Level Options > Link-Control Section			
reg-silent	New	7.5	
reg-delay	New	7.5	

T-Server for Ericsson MD110

Table 47 shows the modifications made to switch-specific options for T-Server for Ericsson MD110 when migrating to its latest release.

Table 47: Option Modifications for T-Server for Ericsson MD110

Option Name	Type of Change	Occurred in Release #	Details
Application-Level Options > TServer Section			
switch-domain-check	New	6.1	
connid-update	New	6.1	
	Removed	8.0	
call-expire-time	New valid values		New values: 150-800
	Removed	7.1	Replaced with <code>expire-call-tout</code> in the CTI-Link section.
call-cleanup-interval	Removed	7.1	Replaced with <code>expire-call-tout</code> in the CTI-Link section.
wrapup-timeout	New valid values		New upper limit: 86400000
	Removed	7.1	Replaced with <code>wrap-up-time</code> .
transfer-emulation	New	6.5.1	
	New default value	7.0	New default value: <code>true</code>
	Removed	7.0.2	
device-snapshot-interval	See Details		New units: seconds Old units: milliseconds
	Removed	7.1	Replaced with <code>expire-call-tout</code> in the CTI-Link section.
is-consult-outbound	New default value	6.5.3	New value: <code>false</code> Old value: <code>true</code>
	See Details	6.5.3	Functionality has changed.
	Removed	7.0	

Table 47: Option Modifications for T-Server for Ericsson MD110 (Continued)

Option Name	Type of Change	Occurred in Release #	Details
acd-login	New	6.5.3	
	Removed	8.0	
analog-transfer	New	6.5.3	
force-snapshot-interval	New	6.5.2	
dest-event-tout	New	6.5.1	
	New default value	6.5.3	New value: 1
	Removed	7.1	
route-request-attempt route-request-attempts	Modified	7.0	Renamed from <code>route-request-attempts</code> to <code>route-request-attempt</code> . You can still use the old name as an alias. Lower limit of valid values changed to 0. Default value changed to 0 in 6.5.3.
adn-login ADN-login	Modified	7.0	Renamed from <code>ADN-login</code> to <code>adn-login</code> . You can still use the old name as an alias. Functionality changed in 6.5.3.
route-consult-call route_consult_call	Modified	7.0	Renamed from <code>route_consult_call</code> to <code>route-consult-call</code> . You can still use the old name as an alias.
	New default value	7.1	Default value changed to <code>true</code> .
ext-routing-min-digits	New valid values		New lower limit: 0
use-makecall-login	New	7.0	
block-failed-dn-tout	New	7.0	
force-pbx-ag-state	New	7.0	
acw-predict-timeout	New	7.0	
	Removed	7.1	Functionality is provided by new libraries.

Table 47: Option Modifications for T-Server for Ericsson MD110 (Continued)

Option Name	Type of Change	Occurred in Release #	Details
login-code	New	7.0	Added to documentation
call-rq-gap	New	7.0	
	See Details	7.1	Moved from TServer section to the CTI-Link section.
min-route-dly	New	7.0.2	
redistr-dly	New	7.0.2	
ext-xfer-min-digits	New	7.0.2	
vto-onhook-delay	New	7.0.2	
log-level	Removed	7.1	
service-busy-attempt	Removed	7.1	
inbound-bsns-calls	New	7.1	
outbound-bsns-calls	New	7.1	
legal-guard-time	New	7.1	
wrap-up-time	New	7.1	
timed-cwk-in-idle	New	7.1	
timed-acw-in-idle	See Details	7.5	Renamed to <code>timed-acw-in-idle</code> . You can still use the old name as an alias.
cwk-in-idle-force-ready	New	7.1	
	See Details	7.5	Renamed to <code>acw-in-idle-force-ready</code> . You can still use the old name as an alias.
agent-strict-id	New	7.1	
	New value added	8.0	New value <code>passwd</code> added.
inherit-bsns-type	New	7.1	
unknown-bsns-calls	New	7.1	
internal-bsns-calls	New	7.1	

Table 47: Option Modifications for T-Server for Ericsson MD110 (Continued)

Option Name	Type of Change	Occurred in Release #	Details
notrdy-bsns-cl-force-rdy	New	7.1	
	Removed	7.5	
unknown-xfer-merge-udata	New	7.1	
prd-dist-call-ans-time	New	7.1	
max-pred-req-delay	New	7.1	
extn-no-answer-timeout	New	7.1	
extn-no-answer-overflow	New	7.1	
posn-no-answer-timeout	New	7.1	
posn-no-answer-overflow	New	7.1	
agent-no-answer-timeout	New	7.1	
agent-no-answer-overflow	New	7.1	
agent-no-answer-action	New	7.1	
supervised-route-timeout	New	7.1	
consult-supervised-rt	New	7.1	
correct-connid	New	7.1	
correct-rqid	New	7.1	
convert-otherdn	New	7.1	
dn-for-undesired-calls	New	7.1	
callback-dn	New	7.1	
nas-private	New	7.2	
recall-no-answer-timeout	New	7.2	
accept-dn-type	New	7.2	
default-dn-type	New	7.2	
dn-del-mode	New	7.2	
ext-redir-min-digits	New	7.2	

Table 47: Option Modifications for T-Server for Ericsson MD110 (Continued)

Option Name	Type of Change	Occurred in Release #	Details
emulate-login	New	7.5	
emulated-login-state	New	7.5	
agent-group	New	7.5	
sync-emu-agent	New	7.5	
untimed-wrap-up-value	New	7.5	
backwds-compat-acw-behavior	New	7.5	
override-switch-acw	New	7.5	
login-pincode	New	7.5	
reason-code	New	7.5	
consult-supervised-rt	See Details	7.5	Default value changed to <code>false</code> .
enable-retain-in-queue	New	7.2	
call-retain-in-queue	New	7.2	
expire-call-tout	New	7.1	
	See Details	7.5	Moved to TServer section from the Link-Control section.
	Removed	7.6	
retain-call-tout	New	7.1	
	See Details	7.5	Moved to TServer section from the Link-Control section.
clid-withheld-name	New	7.6	
queue-return-dly	New	7.6	
wrap-up-threshold	New	7.6	
nas-indication	New	7.6	
sync-emu-acw	New	8.0	
agent-only-private-calls	New	8.0	

Table 47: Option Modifications for T-Server for Ericsson MD110 (Continued)

Option Name	Type of Change	Occurred in Release #	Details
agent-logout-on-unreg	New	8.0	
agent-logout-reassoc	New	8.0	
agent-emu-login-on-call	New	8.0	
call-type-by-dn	New	8.0	
releasing-party-report	New	8.0	
route-failure-alarm-high-wm	New	8.0	
route-failure-alarm-low-wm	New	8.0	
route-failure-alarm-period	New	8.0	
queue-cleanup	Removed	8.0	
force-pbx-ag-state	Removed	8.0	
route-request-attempt	Removed	8.0	
default-destination	Removed	8.0	
Application-Level Options > Application-Link Section			
app-link-version	New valid values	6.5.2	Value 4.0 now applies to BC11 as well as to BC10. Default value changed to 3.0.200 in 6.5.2.
max-outstanding-login-rq	New	7.0	
rq-tout link-rq-timeout	Modified	7.0	Renamed from link-rq-timeout to rq-tout. You can still use the old name as an alias.
	Removed	7.1	Replaced with rq-expire-tmout in the link-control section.

Table 47: Option Modifications for T-Server for Ericsson MD110 (Continued)

Option Name	Type of Change	Occurred in Release #	Details
rd-dly link-rq-delay	New valid values		Default value is 200. Lower limit of valid values is 10.
	Modified	7.0	Renamed from link-rq-delay to rq-dly. You can still use the old name as an alias.
	Removed	7.1	Replaced with rq-gap in the link-control section.
max-outstanding-dev-rq link-max-outstanding-device-rq	Modified	7.0	Renamed from link-max-outstanding-device-rq to max-outstanding-dev-rq. You can still use the old name as an alias.
max-outstanding-rq link-max-outstanding-rq	Modified	7.0	Renamed from link-max-outstanding-rq to max-outstanding-rq. You can still use the old name as an alias.
	Modified	7.0.2	Default value changed from 8 to 4.
	Modified	7.1	Default value changed to 16.
	Removed	7.1	Replaced with max-outstanding in the link-control section.
max-rq-rate link-max-rq-rate	Modified	7.0	Renamed from link-max-rq-rate to max-rq-rate. You can still use the old name as an alias.
	Removed	7.1	
Application-Level Options > Reason-code-end Section (new in 7.5)			
absence-0 ... absence-9	New	7.5	
Application-Level Options > Link-Control Section (new in 7.1)			
The section name changed from the CTI-Link section to the link-control section for 7.1.			
CTI-Link Section	See Details	7.1	Renamed to link-control.
protocol	New default value	6.5.3	New value: tcp Old value: No default value
	Removed	7.1	
hostname	New	6.1	

Table 47: Option Modifications for T-Server for Ericsson MD110 (Continued)

Option Name	Type of Change	Occurred in Release #	Details
port	New	6.1	
ha-sync-dly-lnk-conn	New	7.1	
rq-expire-tout	New	7.1	Replaces <code>rq-tout</code> from the Application-Link section.
restart-period	New	7.1	
reg-interval	New	7.1	
kpl-interval	New	7.1	
kpl-tolerance	New	7.1	
restart-cleanup-limit	New	7.1	
restart-cleanup-dly	New	7.1	
quiet-cleanup	New	7.1	
quiet-startup	New	7.1	
call-max-outstanding	New	7.1	
max-outstanding	New	7.1	Replaces <code>max-outstanding-rq</code> from the Application-Link section.
call-rq-gap	See Details	7.1	Moved from the TServer section.
rq-gap	New	7.1	
reg-delay	New	7.2	
reg-silent	See Details	7.5	Default value change to <code>false</code> .
kpl-loss-rate	New	7.6	
link-alarm-high	New	8.0	
link-alarm-low	New	8.0	
use-link-bandwidth	New	8.0	
rq-conflict-check	New	8.0	
device-rq-gap	New	8.0	
call-max-outstanding	Removed	8.0	

Table 47: Option Modifications for T-Server for Ericsson MD110 (Continued)

Option Name	Type of Change	Occurred in Release #	Details
Application-Level Options > Switch-Specific Type Section (new in 7.2)			
extension	New	7.2	
Agent Login-Level and DN-Level Options > TServer Section			
no-answer-timeout	New	7.0	
no-answer-overflow	New	7.0	
no-answer-action	New	7.0	
dn-for-undesired-calls	New	7.1	
rq-gap	New	8.0	

T-Server for Fujitsu F9600

Table 48 shows the modifications made to switch-specific options for T-Server for Fujitsu F9600, when migrating to its latest release.

Table 48: Option Modifications in T-Server for Fujitsu F9600

Option Name	Type of Change	Occurred in Release #	Details
Application-Level Options > TServer Section			
transfer-delay	New	6.5.3	
notrdy-bsns-cl-force-rdy	New	7.0	
max-pred-req-delay	New	7.0	
extn-no-answer-timeout	New	7.0	
extn-no-answer-overflow	New	7.0	
posn-no-answer-timeout	New	7.0	
posn-no-answer-overflow	New	7.0	
supervised-route-timeout	New	7.0	
acw-predict-delay	New	7.0	
agent-no-answer-timeout	Modified	7.0	

Table 48: Option Modifications in T-Server for Fujitsu F9600 (Continued)

Option Name	Type of Change	Occurred in Release #	Details
agent-no-answer-overflow	Modified	7.0	
agent-no-answer-action	Modified	7.0	
inherit-bsns-type	New	7.0.2	
Application-Level Options > CTI-Link Section			
rq-gap	New default value	7.0	New value: 0 Old value: 10
reg-interval	New	7.0	
hostname host	Modified	7.0.2	Renamed from host to hostname in 7.0.2. You can still use the previous name as an alias.
use-native-routing use-csta-routing	Modified	7.0.2	Renamed from use-csta-routing to use-native-routing. You can still use the previous name as an alias.
call-rq-gap	New	7.0.2	
Agent Login-Level and DN-Level Options > TServer Section			
no-answer-timeout	New	7.0	
no-answer-overflow	New	7.0	
no-answer-action	New	7.0	

T-Server for EADS Intecom M6880

Prior to release 7.0, this product was known as T-Server for Intecom E and prior to that as T-Server for Intecom E and PointSpan.

[Table 49](#) shows the modifications made to switch-specific options for T-Server for EADS Intecom M6880 when migrating to its latest release.

Table 49: Option Modifications in T-Server for EADS Intecom M6880

Option Name	Type of Change	Occurred in Release #	Details
Application-Level Options > TServer Section			
simulate-request-after-login	New	6.5.2	
arc-timeout	New	6.5.2	
outcall-req-timeout	New	6.5.2	
ic-kpl-trace	New	6.5.3	
	Removed	8.0	Replaced with <code>print-heartbeat</code> .
print-heartbeat	New	8.0	
use-oaitk	Removed	6.5.3	
use-db-agent-state	New	6.5.3	
default-user-group	New	6.5.3	
sw-answer-detect-time	New valid value	6.5.3	New valid value: A string value in the format described in “Timeout Value Format” on page 317 . Old value: Any integer
hw-answer-detect-time	New valid value	6.5.3	New valid value: A string value in the format described in “Timeout Value Format” on page 317 . Old value: Any integer
max-call-queue-time	New valid value	6.5.3	New valid value: A string value in the format described in “Timeout Value Format” on page 317 . Old value: Any integer

Table 49: Option Modifications in T-Server for EADS Intecom M6880 (Continued)

Option Name	Type of Change	Occurred in Release #	Details
ring-no-answer-time	New valid value	6.5.3	New valid value: A string value in the format described in “Timeout Value Format” on page 317 . Old value: Any integer
min-call-answer-time	New valid value	6.5.3	New valid value: A string value in the format described in “Timeout Value Format” on page 317 . Old value: Any integer
rec-human-speech-detect	New valid value	6.5.3	
max-resource-wait-time	New valid value	6.5.3	
second-call-as-consult	New	7.2	
distrib-hidden-cims	New	7.5	
on-hook-after-parking	New	7.6	
atdc-no-digits	New	8.0	
atdc-do-not-ignore	New	8.0	
report-release-on-atdc-as	New	8.0	
req-retrieve-conf-support	New	8.0	
station-stat-timeout	New	8.0	
support-atdc	New	8.0	
create-addr-on-register	New	8.0	
Application-Level Options > CTI-Link Section^a			
app-id	Removed	6.5.3	
app-name	Removed	6.5.3	
app-password	Removed	6.5.3	
hostname	New	7.0.2	

Table 49: Option Modifications in T-Server for EADS Intecom M6880 (Continued)

Option Name	Type of Change	Occurred in Release #	Details
protocol	New	7.0.2	
port	New	7.0.2	

- a. Prior to release 6.5, T-Server connected to the Intecom switch using the OAI driver and the CTI-Link section with the options for that connection. Starting with release 6.5, T-Server connects to the switch directly, and the standard options for TCP connections are used.

T-Server for EADS Telecom M6500 Succession

[Table 50](#) shows the modifications made to switch-specific options for the T-Server for EADS Telecom M6500 Succession, when migrating to its latest release.

Table 50: Option Modifications in T-Server for T-Server for EADS Telecom M6500 Succession

Option Name	Type of Change	Occurred in Release #	Details
Application-Level Options > TServer Section			
link- <i>n</i> -name	Modified		Replaced by link- <i>n</i> -tcp.
aport-onhook-delay	New	6.5.2	
link- <i>n</i> -tcp	Modified	6.5.3	Default value changed to Link-tcp.
pbx-monitoring PBX-monitoring	Modified	7.0	Renamed from PBX-monitoring to pbx-monitoring. You can still use the previous name as an alias.
	Removed	7.5	
pbx-version PBX-version	Modified	7.0	Renamed from PBX-version to pbx-version. You can still use the previous name as an alias.
	Removed	7.5	
posn-no-answer-overflow	New	7.0	
posn-no-answer-timeout	New	7.0	
extn-no-answer-overflow	New	7.0	

Table 50: Option Modifications in T-Server for T-Server for EADS Telecom M6500 Succession (Continued)

Option Name	Type of Change	Occurred in Release #	Details
extn-no-answer-timeout	New	7.0	
agent-no-answer-action	New	7.0	
agent-no-answer-overflow	New	7.0	
agent-no-answer-timeout	New	7.0	
expire-call-tout	New	7.5	
unknown-xfer-merge-udata	New	7.5	
agent-group	New	7.5	
agent-strict-id	New	7.5	
legal-guard-time	New	7.5	
untimed-wrap-up-value	New	7.5	
inbound-bsns-calls	New	7.5	
outbound-bsns-calls	New	7.5	
internal-bsns-calls	New	7.5	
unknown-bsns-calls	New	7.5	
timed-acw-in-idle	New	7.5	
acw-in-idle-force-ready	New	7.5	
inherit-bsns-type	New	7.5	
backwds-compat-acw-behavior	New	7.5	
override-switch-acw	New	7.5	
nas-private	New	7.5	
recall-no-answer-timeout	New	7.5	
prd-dist-call-ans-time	New	7.5	
max-pred-req-delay	New	7.5	
accept-dn-type	New	7.5	

Table 50: Option Modifications in T-Server for T-Server for EADS Telecom M6500 Succession (Continued)

Option Name	Type of Change	Occurred in Release #	Details
default-dn-type	New	7.5	
dn-del-mode	New	7.5	
emulate-login	New	7.5	
emulated-login-state	New	7.5	
wrap-up-time	New	7.5	
sync-emu-agent	New	7.5	
retain-call-tout	New	7.5	
auto-xfer-dly	New	7.5	
correct-connid	New	7.5	
correct-rqid	New	7.5	
convert-otherdn	New	7.5	
dn-for-undesired-calls	New	7.5	
supervised-route-timeout	New	7.5	
consult-supervised-rt	New	7.5	
password-separator	Removed	7.5	
max-bad-rtreq	Removed	7.5	
call-expire-time	Removed	7.5	
aport-onhook-delay	Removed	7.5	
call-report-rqmembers	Removed	7.5	
Application-Level Options > Log-CTRL Section (Removed in 7.5)			
log-con-conf	Removed	7.5	
Application-Level Options > Channel-Conf Section (Removed in 7.5)			
channel-max-host-rq	Removed	7.5	
channel-max-device-rq	Removed	7.5	

Table 50: Option Modifications in T-Server for T-Server for EADS Telecom M6500 Succession (Continued)

Option Name	Type of Change	Occurred in Release #	Details
channel-rq-gap	Removed	7.5	
channel-rq-timeout	Removed	7.5	
number-of-links	Removed	7.5	
link-1-tcp	Removed	7.5	
Application-Level Options > Link-Control Section (New in 7.5)			
reg-delay	New	7.5	
reg-silent	New	7.5	
hostname	New	7.5	
port	New	7.5	
max-outstanding	New	7.5	
rq-gap	New	7.5	
restart-period	New	7.5	
restart-cleanup-limit	New	7.5	
restart-cleanup-dly	New	7.5	
quiet-cleanup	New	7.5	
quiet-startup	New	7.5	
rq-expire-tout	New	7.5	
call-rq-gap	New	7.5	
ha-sync-dly-lnk-conn	New	7.5	
Application-Level Options > Link-TCP Section (Removed in 7.5)			
iface	Modified	6.5.3	Default value changed to TCP.
	Removed	7.5	
iface-polltime	Modified	6.5.3	Default value changed to 20.
	Removed	7.5	

Table 50: Option Modifications in T-Server for T-Server for EADS Telecom M6500 Succession (Continued)

Option Name	Type of Change	Occurred in Release #	Details
iface-rdelay	Removed	7.5	
iface-address	Removed	7.5	
iface-port	Removed	7.5	
iface-use-len	Removed	7.5	
iface-pheader-len	Removed	7.5	
iface-app-proto	Removed	7.5	
Application-Level Options > Switch-Specific Type Section (New in 7.5)			
extension	New	7.5	
routing-point	New	7.5	
Agent Login-Level and DN-Level Options > TServer Section			
no-answer-timeout	New	7.0	
no-answer-overflow	New	7.0	
no-answer-action	New	7.0	

T-Server for Huawei C&C08

[Table 51](#) shows the modifications made to switch-specific options for the T-Server for Huawei C&C08 when migrating to its latest release.

Table 51: Option Modifications in T-Server for Huawei C&C08

Option Name	Type of Change	Occurred in Release #	Details
Application-Level Options > TServer Section			
agent-no-answer-action	New	6.5.2	
	Modified	7.0	Functionality modified
agent-no-answer-overflow	New	6.5.2	
	Modified	7.0	Functionality modified

Table 51: Option Modifications in T-Server for Huawei C&C08 (Continued)

Option Name	Type of Change	Occurred in Release #	Details
agent-no-answer-timeout	New	6.5.2	
	Modified	7.0	Functionality modified
posn-no-answer-overflow	New	7.0	
posn-no-answer-timeout	New	7.0	
extn-no-answer-overflow	New	7.0	
extn-no-answer-timeout	New	7.0	
outbound-bsns-calls	New	7.0	
inbound-bsns-calls	New	7.0	
Application-Level Options > CTI-Link Section			
reg-interval	Modified	6.5.3	Default value changed to 0.
hostname host	Modified	7.0	Name changed from host to hostname. You can still use the previous value as an alias.
expire-call-tmout	New	7.0.2	
call-rq-gap	New	7.0.2	
Agent Login-Level and DN-Level Options > TServer Section			
no-answer-timeout	New	7.0	
no-answer-overflow	New	7.0	
no-answer-action	New	7.0	

T-Server for Meridian 1

Starting with release 7.1, the functionality of Meridian 1 and Symposium Call Center Server T-Servers are combined into one T-Server. See “T-Server for Nortel Communication Server 1000 with SCCS/MLS” on [page 376](#).

T-Server for Mitel SX-2000/MN-3300

Table 52 shows the modifications made to switch-specific options for the T-Server for Mitel SX-2000/MN-3300 when migrating to its latest release.

Table 52: Option Modifications in T-Server for Mitel SX-2000/MN-3300

Option Name	Type of Change	Occurred in Release #	Details
Application-Level Options > TServer Section			
agent-strict-id	New	6.5.1	
cwk-in-idle-force-ready	New	6.5.1	
timed-cwk-in-idle	New	6.5.1	
wrap-up-time	New	6.5.1	
legal-guard-time	New	6.5.1	
outbound-bsns-calls	New	6.5.1	
inbound-bsns-calls	New	6.5.1	
agent-emu-sync	New	6.5.2	
prd-dist-call-ans-time	New	6.5.2	
shutdown-limit	Removed	6.5.2	
agent-no-answer-overflow	New	6.5.2	
	Modified	7.0	Functionality modified
agent-no-answer-timeout	New	6.5.2	
	Modified	7.0	Functionality modified
extn-no-answer-overflow	New	7.0	
extn-no-answer-timeout	New	7.0	
supervised-route-timeout	New	7.0	
posn-no-answer-overflow	New	7.0	
posn-no-answer-timeout	New	7.0	
max-pred-req-delay	New	7.0	
notrdy-bsns-cl-force-rdy	New	7.0	

Table 52: Option Modifications in T-Server for Mitel SX-2000/MN-3300 (Continued)

Option Name	Type of Change	Occurred in Release #	Details
inherit-bsns-type	New	7.0.2	
expire-call-tout	See Details	7.2	Renamed from <code>expire-call-tmout</code> and moved from CTI-Link section.
retain-call-tout	See Details	7.2	Renamed from <code>retain-call-tmout</code> and moved from CTI-Link section.
unknown-xfer-merge-udata	New	7.2	
agent-group	New	7.2	
untimed-wrap-up-value	New	7.2	
internal-bsns-calls	New	7.2	
unknown-bsns-calls	New	7.2	
timed-acw-in-idle	See Details	7.2	Renamed from <code>timed-cwk-in-idle</code> .
acw-in-idle-force-ready	See Details	7.2	Renamed from <code>cwk-in-idle-force-ready</code> .
backwds-compat-acw-behavior	New	7.2	
override-switch-acw	New	7.2	
nas-private	New	7.2	
recall-no-answer-timeout	New	7.2	
accept-dn-type	New	7.2	
default-dn-type	New	7.2	
dn-del-mode	New	7.2	
accode-privateservice	New	7.2	
accode-data	New	7.2	
accode-name	New	7.2	
accode-index	New	7.2	
emulate-login	New	7.2	
emulated-login-state	New	7.2	

Table 52: Option Modifications in T-Server for Mitel SX-2000/MN-3300 (Continued)

Option Name	Type of Change	Occurred in Release #	Details
agent-strict-d	New	7.2	
sync-emu-agent	New	7.2	
callback-dn	New	7.2	
retain-call-tout	New	7.2	
correct-connid	New	7.2	
correct-rqid	New	7.2	
convert-otherdn	New	7.2	
dn-for-undesired-calls	New	7.2	
remote-xfer-report	New	7.2	
divert-tout	New	7.2	
intrude-pty-change	New	7.2	
single-cpu-affinity	New	7.2	
mitai-log-path	New	7.2	
timed-cwk-in-idle	Removed	7.2	
cwk-in-idle-force-ready	Removed	7.2	
notrdy-bsns-cl-force-rdy	Removed	7.2	
agent-emu-sync	Removed	7.2	
dn-del-mode	Removed	7.2	Introduced in 7.2. Removed in 7.2.001.
Application-Level Options > Switch-Specific Type Section (new in 7.2)			
routing-point	New	7.2	
extension	New	7.2	
Agent Login-Level and DN-Level Options > TServer Section			
no-answer-timeout	New	7.0	
no-answer-overflow	New	7.0	
no-answer-action	New	7.0	

Table 52: Option Modifications in T-Server for Mitel SX-2000/MN-3300 (Continued)

Option Name	Type of Change	Occurred in Release #	Details
Application-Level Options > CTI-Link Section			
route-gap	Removed	6.5.2	
kpl-tolerance	New	6.5.2	
	Removed	7.0.2	
poll-interval	Modified	6.5.3	Default value changed from 33 to 100.
mitai-log-severity log-severity	Modified	7.0	Renamed from log-severity to mitai-log-severity. You can still use the old name for backward compatibility.
mitai-logfile-size log-rile-size	Modified	7.0	Renamed from log-file-size to mitai-logfile-size. You can still use the old name for backward compatibility.
mitai-logfile-path log-file-path	Modified	7.0	Renamed from log-file-path to mitai-logfile-path. You can still use the old name for backward compatibility.
mitai-runtime-dir runtime-dir	Modified	7.0	Renamed from runtime-dir to mitai-runtime-dir. You can still use the old name for backward compatibility.
mitai-trunk-correction trunk-correction	Modified	7.0	Renamed from trunk-connection to mitai-trunk-connection. You can still use the old name for backward compatibility.
mitai-timeout timeout	Modified	7.0	Renamed from timeout to mitai-timeout. You can still use the old name for backward compatibility.
mitai-service service	Modified	7.0	Renamed from service to mitai-service. You can still use the old name for backward compatibility.
hostname gateway	Modified	7.0	Renamed from gateway to hostname. You can still use the old name for backward compatibility.

Table 52: Option Modifications in T-Server for Mitel SX-2000/MN-3300 (Continued)

Option Name	Type of Change	Occurred in Release #	Details
call-rq-gap	New	7.0	
	Modified	7.0.2	Default value changed from: <ul style="list-style-type: none"> • 300 to 1000 in 7.0.200.10 • 1000 to 250 in 7.0.201.05
max-outstanding	Modified	7.0.2	Default value changed from 3 to 255.
hci-reset	Removed	7.0.2	
backup-mode	Removed	7.0.2	
reg-delay	New	7.2	
reg-silent	New	7.2	
restart-cleanup-limit	New	7.2	
restart-cleanup-dly	New	7.2	
quiet-cleanup	New	7.2	
quiet-startup	New	7.2	
ha-sync-dly-lnk-conn	New	7.2	
rq-expire-tmout	See Details	7.2	Renamed to rq-expire-tout.
mitai-service	Removed	7.2	
mitai-timeout	Removed	7.2	
mitai-trunk-correction	Removed	7.2	
mitai-runtime-dir	Removed	7.2	
mitai-log-file-path	Removed	7.2	
mitai-log-file-size	Removed	7.2	
mitai-log-severity	Removed	7.2	
unregister	Removed	7.2	

T-Server for NEC NEAX/APEX

Table 53 shows the modifications made to switch-specific options for T-Server for NEC NEAX/APEX when migrating to its latest release.

Table 53: Option Modifications in T-Server for NEC NEAX/APEX

Option Name	Type of Change	Occurred in Release #	Details
Application-Level Options > TServer Section			
consult-user-data	New	6.5.0	
trace-level	New default value	6.5.2	New value: level 2 Old value: level 1
trace-modules	New default values	6.5.2	New values: +all, -hash Old value: all
login-mode	New default value	6.5.2	New value: 2 Old value: 0
enable-alive-message	New default value	6.5.2	New value: true Old value: false
answer-mode	New default value	6.5.2	New value: 1 Old value: 3
max-calls	New default value	6.5.2	New value: 2003 Old value: 523
max-dns	New default value	6.5.2	New values: +all, -hash Old value: all
suppress-trunk-events	New default value	6.5.2	New value: false Old value: true
transfer-allow	New	6.5.2	
tenant-number	See Details	6.5.2	The option description has been updated.
tenant-number-list	New	6.5.2	
software-agent-state	New	6.5.3	
fix-double-hold	New	6.5.3	
no-response-timeout	New	7.0	

Table 53: Option Modifications in T-Server for NEC NEAX/APEX (Continued)

Option Name	Type of Change	Occurred in Release #	Details
make-call-agent-ppn	New	6.5.1	
message-record-size	Obsolete	7.0	
message-record-timeout	Obsolete	7.0	
message-record-increment	Obsolete	7.0	
link-up-delay	Obsolete	7.0	
merge-consult-data	Obsolete	7.0	Use <code>consult-user-data</code> instead.
scf10-answer-type	New	7.1	
fix-supervisor-release	New	7.1	
enable-query-addr-status	New	7.1	
enable-ssc	New	7.1	
number-of-links	New	7.1	
link-type	New	7.1	
snd-scf2-delay	New	7.2	
enable-query-dnd-status	New	7.2	
enable-query-fwd-status	New	7.2	
enable-query-mwl-status	New	7.2	
monitor-delay	Obsolete	7.6	
link-delay	Obsolete	7.6	
register-retries	Obsolete	7.6	
register-retry-delay	Obsolete	7.6	
oai-hold	See Details	7.6	The default value was changed to <code>true</code> .
monitor-call-using	New	8.0	
simulate-established	Obsolete	8.0	
simulate-established-delay	Obsolete	8.0	

Table 53: Option Modifications in T-Server for NEC NEAX/APEX (Continued)

Option Name	Type of Change	Occurred in Release #	Details
transfer-release-delay	Modified	8.0	T-Server now requests a switch to release a transferring party.
Unlicensed DN Section - Removed in 7.5			
<n>	Obsolete	7.5	See the <i>T-Server Deployment Guide</i> for instructions on configuring unlicensed DNs.

T-Server for Nortel Communication Server 1000 with SCCS/MLS

Starting with release 7.1, the functionality of Meridian 1 and Symposium Call Center Server T-Servers are combined into one T-Server. The current name is T-Server for Nortel Communication Server 1000 with SCCS/MLS.

[Table 54](#) shows the modifications made to switch-specific options for the T-Server for Nortel Communication Server 1000 with SCCS/MLS when migrating to its latest release.

Table 54: Option Modifications in T-Server for T-Server for Nortel Communication Server 1000 with SCCS/MLS

Option Name	Type of Change	Occurred in Release #	Details
Application-Level Options > TServer Section			
link-configuration	New	6.0	
mink-application-id mink-customer-number mink-host-id mink-poll-interval	Removed	6.0	See replacement options listed in the “CTI-Link Section.”
max-attempts-to-register	New	6.5.2	
ev-party-changed-for-cdn	New default value	6.5.2	New value: on Old value: off
cdn-cabq-timeout	New	6.5.3	

Table 54: Option Modifications in T-Server for T-Server for Nortel Communication Server 1000 with SCCS/MLS (Continued)

Option Name	Type of Change	Occurred in Release #	Details
link-type	New	6.5.3	Note: Do not set this option.
	New default value	7.1	New default value: symposium Old value: meridian
agent-compat-flags	New	7.0	
	Removed	7.1	
update-login-on-err	New	7.1	
acw-by-request-only	New	7.1	
make-call-manner	New	7.1	
response-timeout	New	7.1	
	Modified	7.6	Option description is updated.
out-of-service-retry-interval	New	7.1	
scu-emerg-type	New default value	7.1	New default value: 0xc
no-call-disconnect	New default value	7.1	Default changed to 0 (all).
set-dnis-from-dest	Modified	7.1	Range of possible values reduced to on or off (default).
delete-external-call-timeout delete-call-timeout	Modified	7.1	Name changed from delete-call-timeout to delete-external-call-timeout. Default now 30 seconds.
orig-callid-xfer-conf-init	See Details	7.1	Renamed from orig-call-xfer-init to orig-callid-xfer-conf-init.
link-configuration	Removed	7.1	
internal-addr-length	Removed	7.1	
complete-xfer-on-disc	Removed	7.1	
attach-cdn-info	Removed	7.1	
no-callid-release	Removed	7.1	

Table 54: Option Modifications in T-Server for T-Server for Nortel Communication Server 1000 with SCCS/MLS (Continued)

Option Name	Type of Change	Occurred in Release #	Details
wrong-callid-release	Removed	7.1	
rr-call-delay	Removed	7.1	
rls-ext-consult	Removed	7.1	
delete-sc-offh	Removed	7.1	
scan-call-interval	Removed	7.1	
support-networked-call	Removed	7.1	
accept-multiple-ring	Removed	7.1	
normalize-on-scr	Removed	7.1	
normalize-on-rr	Removed	7.1	
dta-cleanup-orig-rr	Removed	7.1	
dta-cleanup-orig-scr	Removed	7.1	
dta-cleanup-orig-sca	Removed	7.1	
rls-scd-no-type	Removed	7.1	
support-tat	Removed	7.1	
ev-party-changed	Removed	7.1	
callpilot-dn-range	New	7.2	
enable-consult-swap	New	7.2	
uudata-attach-type	New	7.2	
routing-state-timeout	New	7.5	
default-agent-id-is-position	New	7.5	
soft-tacw-support	New	7.5	
soft-wrap-up-time	New	7.5	
terminal-id	New	7.5	
set-discovery	New	7.6	

Table 54: Option Modifications in T-Server for T-Server for Nortel Communication Server 1000 with SCCS/MLS (Continued)

Option Name	Type of Change	Occurred in Release #	Details
create-addr-on-register	New	7.2	
rtp-info-password	New	7.6	
update-login-on-err	New	7.6	
dest-busy-codes	New	8.0	
dest-busy-invalid-num-codes	New	8.0	
Application-Level Options > CTI-Link Section			
mail-name	New location	6.0	New location: CTI-Link section
application-id	New	6.0	Replaces: mlink-application-id
customer-number	New	6.0	Replaces: mlink-customer-number
host-id	New	6.0	Replaces: mlink-host-id
poll-interval	New	6.0	Replaces: mlink-poll-interval
protocol	New valid value	6.5.3	tcp is the only valid value.
version	Removed	7.0	
DN-Level Options > TServer section			
default-agent-id	New	7.5	
vtport-generate-hook-events	New	7.6	

T-Server for Nortel Communication Server 2000/2100

Prior to release 7.1, this product was known as T-Server for Nortel DMS-100.

[Table 55](#) shows the modifications made to switch-specific options for T-Server for Nortel Communication Server 2000/2100 when migrating to its latest release.

Table 55: Option Modifications in T-Server for Nortel Communication Server 2000/2100

Option Name	Type of Change	Occurred in Release #	Details
Application-Level Options > TServer Section			
send-not-ready	Changes take effect	6.1	This option now supports dynamic changes.
	Removed	7.0.1	The functionality of these options is now available in the T-Server's default behavior.
use-query-dn	Changes take effect	6.1	This option now supports dynamic changes.
hex-dump	Changes take effect	6.1	This option now supports dynamic changes.
	Removed	7.6	
dn-query-info	Changes take effect	6.1	This option now supports dynamic changes.
	Removed	7.6	
unreg-dn-on-dms	Changes take effect	6.1	This option now supports dynamic changes.
	Removed	7.6	T-Server now uses a standard behavior to never disassociate a DN from the switch if the DN is in Configuration Manager. T-Server always disassociates a DN from the switch if the DN is not in Configuration Manager and no clients are registered for that DN.
send-agent-ready	Changes take effect	6.1	This option now supports dynamic changes.
	Removed	7.0.1	The functionality of these options is now available in the T-Server's default behavior.

Table 55: Option Modifications in T-Server for Nortel Communication Server 2000/2100 (Continued)

Option Name	Type of Change	Occurred in Release #	Details
send-result-on-error	Changes take effect	6.1	This option now supports dynamic changes.
send-retrieved	Changes take effect	6.1	This option now supports dynamic changes.
orig-inbound-to-dnis	Changes take effect	6.1	This option now supports dynamic changes.
dms-upgrade-time	Changes take effect	6.1	This option now supports dynamic changes.
no-other-dn-for-external	Changes take effect	6.1	This option now supports dynamic changes.
	Removed	7.6	
nlinks	Removed	6.5.0	The value specified in the <code>nlinks</code> configuration option no longer supersedes the number of links specified in the <code>link-n-name</code> option. With the 6.5 T-Server, a connection is made to each instance of <code>link-n-name</code> present in the <code>tserver</code> configuration section.
max-call-time-primary	See Details	6.1	This option now supports dynamic changes.
	New valid value	6.5.0	New value: <code>0-900000</code>
	New default value	6.5.0	New value: <code>36000</code>
	Obsolete	7.1	See your <i>T-Server Deployment Guide</i> for details.
	Removed	7.6	

Table 55: Option Modifications in T-Server for Nortel Communication Server 2000/2100 (Continued)

Option Name	Type of Change	Occurred in Release #	Details
max-call-time-backup	Changes take effect	6.1	This option now supports dynamic changes.
	New valid value	6.5.0	New value: 0-900000
	New default value	6.5.0	New value: 1000
	New default value	7.0.1	New default value: 36000 Old default value: 1000
	Obsolete	7.1	See your <i>T-Server Deployment Guide</i> for details
	Removed	7.6	
call-progress	New	6.5.0	
call-exist-time	New valid values	6.5.0	New value: 0-900000
	Changes take effect	6.1	This option now supports dynamic changes.
	Removed	7.6	
new-call-for-unknown-dest	New	6.5.0	
dial-plan-prefix	New	6.5.1	
	New valid values	6.5.2	New values: Any comma-delimited list of dialing prefixes (for example, 1, 9, 19)
use-dial-plan	See Details	6.5.1	The option <code>set-call-type-with-dialing</code> now manages the call type in dialing, while <code>use-dial-plan</code> indicates the possibilities for T-Server of the values given in <code>dial-plan-prefix</code> for comparing some DN values.
set-call-type-with-dialing	New	6.5.1	

Table 55: Option Modifications in T-Server for Nortel Communication Server 2000/2100 (Continued)

Option Name	Type of Change	Occurred in Release #	Details
logon-hard-reset	New	6.5.2	Note: This option has a requirement of SCAI version 17 or later.
use-supp-in-queued	New	6.5.3	
unregister-mode unregister-delay unregister-interval	Removed	6.5.3	The <code>register-interval</code> option applies to both registration and unregistration of DNSs.
register-interval	See Details	6.5.3	Now used for both registering and unregistering of addresses. Previously, <code>unregister-interval</code> was used for unregistering.
	Removed	7.6	The <code>flow-control</code> settings is used instead to control the flow of registration (and other) requests.
rp-xfer-mode	Removed	6.5.3	
retain-consult-data provide-orig-data	Removed	6.5.3	The common option <code>consult-user-data</code> should be used.
sync-addresses	New	7.0	
ha-heartbeat-period	New	7.0	
ha-heartbeat-timeout	New	7.0	
ha-heartbeat-failures	New	7.0	
appl-logon-already-ok	New	7.0.2	
send-answer-after-make	New	7.0.2	
agent-state-return-result	New	7.0.2	
noncontroller-released-digits	New	7.0.2	
	Modified	7.6	The default value was changed from 20 to 4.

Table 55: Option Modifications in T-Server for Nortel Communication Server 2000/2100 (Continued)

Option Name	Type of Change	Occurred in Release #	Details
sync-agent-state-after-released	New	7.0.2	
	Removed	7.6	The agent state is now always synchronized after a call is released. Multilink issues that previously required this feature to sometimes be turned off have been resolved.
change-dnis	New	7.1	
	Removed	7.6	The attribute DNIS, once set for a call, now never needs to be changed. This is standard T-Server behavior required by some clients.
address-sync-timeout	New	7.1	
	Removed	7.6	The option request-timeout is now used for address queries.
error-on-agent-state	New	7.1	
flow-control-period	New	7.2	
flow-control-rate	New	7.2	
	Removed	8.0	
flow-control-warning	New	7.2	
mute-xfer-retry-delay	New	7.2	
mute-xfer-retries	New	7.2	
link-stop-delay	New	7.2	
continuity-test-fail-number	Modified	7.5	Option description is modified.
dual-links	New	7.5	
mute-xfer-retries	New	7.5	
mute-xfer-retry-delay	New	7.5	

Table 55: Option Modifications in T-Server for Nortel Communication Server 2000/2100 (Continued)

Option Name	Type of Change	Occurred in Release #	Details
dn-reset-timeout	New	7.5	
	Removed	7.6	The request-timeout option is used for each individual request in reset.
request-timeout	New	7.5	
	Modified	7.6	Valid values are now 1000 to 60000.
link-restart-interval	New	7.5	
ncr-enabled	New	7.6	
call-held-enabled	New	7.6	
call-delete-delay	Removed	7.6	
external-mute-transfer-delay	Removed	7.6	The mute-transfer-delay option is now used for all consult call types. (External and internal).
max-register-retries	New	7.6	
agent-no-answer-action	New	7.6	
agent-no-answer-overflow	New	7.6	
agent-no-answer-timeout	New	7.6	
create-addr-on-register	New	8.0	
soft-login-support	New	7.6	
soft-wrap-up-time	New	7.6	
link-alarm-high	New	8.0	
Application-Level Options > CTI-Link Section			
pvc-channel	New	8.0	

HA Proxy for Nortel Communication Server 2000/2100

Prior to release 7.1, this product was known as HA Proxy for Nortel DMS-100.

[Table 56](#) shows the modifications made to switch-specific options for the HA Proxy for Nortel Communication Server 2000/2100 when migrating to its latest release.

Table 56: Option Modifications in HA Proxy for Nortel Communication Server 2000/2100

Option Name	Type of Change	Occurred in Release #	Details
Application-Level Options > HA Proxy Section			
ha-heartbeat-period	New	7.0	
ha-heartbeat-timeout	New	7.0	
ha-heartbeat-failures	New	7.0	
restart-delay	Modified	7.5	The default value of 0 was changed to 2 to correct an error in documentation.

T-Server for Philips Sopho iS3000

[Table 57](#) shows the modifications made to switch-specific options for T-Server for Philips Sopho iS3000 when migrating to its latest release.

Table 57: Option Modifications in T-Server for Philips Sopho iS3000

Option Name	Type of Change	Occurred in Release #	Details
Application-Level Options > TServer Section			
wrap-up-time	New	6.5.1	
legal-guard-time	New	6.5.1	
timed-cwk-in-idle	New	6.5.1	
cwk-in-idle-force-ready	New	6.5.1	
inbound-bsns-calls	New	6.5.1	
outbound-bsns-calls	New	6.5.1	
agent-no-answer-timeout	New	6.5.2	
	Modified	7.0	

Table 57: Option Modifications in T-Server for Philips Sopho iS3000 (Continued)

Option Name	Type of Change	Occurred in Release #	Details
agent-no-answer-overflow	New	6.5.2	
	Modified	7.0	
agent-no-answer-action	New	6.5.2	
	Modified	7.0	
prd-dist-ans-call-time	New	6.5.2	
	New default value	6.5.3	New value: 0
supervised-route-timeout	New	6.5.2	
agent-strict-id	New	6.5.2	
consult-supervised-rt	New	7.0	
extn-no-answer-overflow	New	7.0	
extn-no-answer-timeout	New	7.0	
max-pred-req-delay	New	7.0	
notrdy-bsns-cl-force-rdy	New	7.0	
posn-no-answer-overflow	New	7.0	
posn-no-answer-timeout	New	7.0	
inherit-bsns-type	New	7.0.2	
Application-Level Options > CTI-Link Section			
kpl-interval	New	6.1.0	
answer-code	New	6.5.2	
reg-interval	New	6.5.2	
kpl-tolerance	New	6.5.2	
shutdown-limit	Removed	6.5.2	
reroute-gap	Removed	6.5.2	
rq-expire-timeout	New default value		New value: 10000

Table 57: Option Modifications in T-Server for Philips Sopho iS3000 (Continued)

Option Name	Type of Change	Occurred in Release #	Details
restart-period	New default value		New value: 30
max-outstanding	New default value		New value: 8
backup-mode	New	6.5.3	Default value: direct
protocol	Removed	6.5.3	
hostname link-host	Modified	7.0	Named changed to hostname in 7.0. You can still use the old name as an alias.
port link-port	Modified	7.0	Name changed to port in 7.0. You can still use the old name as an alias. Default value changed from none to 2555 in 7.0.
rq-gap	New	7.0.2	
call-rq-gap	New	7.0.2	
Agent Login-Level and DN-Level Options > TServer Section			
no-answer-timeout	New	7.0	
no-answer-overflow	New	7.0	
no-answer-action	New	7.0	

HA Proxy for Philips Sopho iS3000

Table 58 shows the modifications to options for the HA Proxy for Philips Sopho iS3000, when migrating to its latest release.

Table 58: Option Modifications in HA Proxy for Philips Sopho iS3000

Option Name	Type of Change	Occurred in Release #	Details
host link-host	Renamed	6.5.2	Old value: host New value: link-host
port link-port	Renamed	6.5.2	Old value: port New value: link-port

Table 58: Option Modifications in HA Proxy for Philips Sopho iS3000

Option Name	Type of Change	Occurred in Release #	Details
switch	Removed	6.5.2	
timeout	New	6.5.2	
keep-connection	New	6.5.2	
shutdown-limit	New	6.5.2	

T-Server for Rockwell Spectrum

Table 59 shows the modifications made to switch-specific options for T-Server for Rockwell Spectrum, when migrating to its latest release.

Table 59: Option Modifications in T-Server for Rockwell Spectrum

Option Name	Type of Change	Occurred in Release #	Details
Application-Level Options > TServer Section			
script-prefix	Removed	6.1.1	Replaced with queue-prefix.
route-script-prefix	See Details	6.1.1	Replaced with route-dn-prefix.
detection	See Details	6.1.1	Replaced with detection-method.
answer-detection	See Details	6.1.1	Replaced with answering-machine-application.
rtt-time-limit	See Details	6.1.1	Replaced with poll-interval in the CTI-Link section.
link-keepalive-counter	See Details	6.1.1	Replaced with poll-interval in the CTI-Link section.
queue-prefix	New	6.1.1	Replaces: script-prefix.
route-dn-prefix	New	6.1.1	Replaces: route-script-prefix.
detection-method	New	6.1.1	Replaces: detection.
answering-machine-application	New	6.1.1	Replaces: answer-detection.
bypass-bad-packet	Removed	6.1.1	

Table 59: Option Modifications in T-Server for Rockwell Spectrum (Continued)

Option Name	Type of Change	Occurred in Release #	Details
rc-rate	Removed	6.1.1	
	Re-introduced	7.0.2	
trunk-group-prefix	Removed	6.1.1	
use-host-info-as-dn	Obsolete	7.0.2	
	Re-introduced	7.1	The default value is now <code>true</code> .
user-data-limit	New	7.0	
attach-acc-host-info	Obsolete	7.0.2	
show-dialing-dn	Obsolete	7.0.2	
	Re-introduced	7.1	Functionality is extended. The option is added back to the current options.
old-queue-style	Obsolete	7.0.2	
null-dn	Obsolete	7.0.2	
vag-support	New	7.1	
agent-group-prefix	New	7.1	
ignore-unknown-appl	New	7.1	
lan-agent-support	New	7.2	
allow-split-conference	New	7.6	
create-addr-on-register	New	8.0	
Application-Level Options > CTI-Link Section			
poll-interval	New	6.1.1	
	Modified	7.6	This option now supports dynamic changes.

T-Server for Siemens Hicom 300/HiPath 4000 CSTA I

Prior to release 6.5.3, this product was known as T-Server for Hicom 300.

Table 60 shows the modifications made to switch-specific options for T-Server for Siemens Hicom 300/HiPath 4000 CSTA I, when migrating to its latest release.

Table 60: Option Modifications in T-Server for Siemens Hicom 300/HiPath 4000 CSTA I

Option Name	Type of Change	Occurred in Release #	Details
Application-Level Options > TServer Section			
time-out	Removed	6.5	Replaced with <code>call-delete-timeout</code>
	New default value	6.5	Old value: 1800
call-delete-timeout	New default value	6.5	New value: 60
	Removed	7.1	Replaced with <code>retain-call-tout</code> and <code>expire-call-tout</code> .
use-predefined-keys	New	6.5	Supports the inclusion of predefined keys in the user data.
hicom300E-version	New default value		Removed
host-routing	New	6.5.2	
	New default value	6.5.3	New value: <code>false</code> Old value: <code>true</code>
	See Details	6.5.3	Functionality modified.
link- <i>n</i> -name	New default value	6.5	New value: <code>link-tcp</code>
	Removed	7.1	
uui-as-text	New	6.5.2	
	New default value and valid values	6.5.3	New value: <code>false</code> New valid values: <code>true</code> and <code>false</code> Old valid values: <code>text</code> and <code>binary</code>

Table 60: Option Modifications in T-Server for Siemens Hicom 300/HiPath 4000 CSTA I (Continued)

Option Name	Type of Change	Occurred in Release #	Details
agent-dev-check	New	6.5.3	
	Removed	7.1	
late-release	New	6.5.3	
request-timeout	New	6.5.2	
	New default value	6.5.3	New value: 10000
	Removed	7.1	Replaced with rq-expire-tout.
agent-clean-login	New	7.0	
transfer-timer xfer-timer	New	7.0	
	Modified	7.1	Renamed to transfer-timer. Old name still available as an alias.
soft-login-support	New	7.0	
	Removed	7.5	
soft-wrap-up-time wrap-up-time	New	7.0	
	Renamed	7.1	Replaced with wrapup-time.
divert-call-srvc-tout divert-call-service-timeout	Modified	7.0.2	Name changed from divert-call-service-timeout to divert-call-srvc-tout. Old name still available as an alias.
	Removed	7.1	
hicom300e-load-limit hicom300E-load-limit	Renamed	7.0.2	Renamed from hicom300E-load-limit to hicom300e-load-limit. Old name still available as an alias.
	Removed	7.1	
hicom300e-version hicom300E-version	Renamed	7.0.2	Renamed from hicom300E-version to hicom300e-version. Old name still available as an alias.
	Removed	7.1	

Table 60: Option Modifications in T-Server for Siemens Hicom 300/HiPath 4000 CSTA I (Continued)

Option Name	Type of Change	Occurred in Release #	Details
transfer-delay	New	7.0.2	
reconnect-timeout	Removed	7.1	See new option restart-period.
rtt-time-limit	Removed	7.1	See new options kpl-interval and kpl-tolerance.
link-keepalive-counter	Removed	7.1	See new options kpl-interval and kpl-tolerance.
inbound-bsns-calls	New	7.1	
outbound-bsns-calls	New	7.1	
legal-guard-time	New	7.1	
agent-strict-id	New	7.1	
inherit-bsns-type	New	7.1	
unknown-bsns-calls	New	7.1	
internal-bsns-calls	New	7.1	
unknown-xfer-merge-udata	New	7.1	
prd-dist-call-ans-time	New	7.1	
max-pred-req-delay	New	7.1	
extn-no-answer-timeout	New	7.1	
extn-no-answer-overflow	New	7.1	
posn-no-answer-timeout	New	7.1	
posn-no-answer-overflow	New	7.1	
agent-no-answer-timeout	New	7.1	
agent-no-answer-overflow	New	7.1	
agent-no-answer-action	New	7.1	
recall-no-answer-timeout	New	7.1	
supervised-route-timeout	New	7.1	

Table 60: Option Modifications in T-Server for Siemens Hicom 300/HiPath 4000 CSTA I (Continued)

Option Name	Type of Change	Occurred in Release #	Details
consult-supervised-rt	New	7.1	
emu-sstr	New	7.1	
rel-cons-reconnect	New	7.1	
new-iscc-tag	New	7.1	
correct-connid	New	7.1	
correct-rqid	New	7.1	
callback-dn	New	7.1	
pend-state-sync-tout	New	7.1	
accode-agent	New	7.1	
acw-retain-call	New	7.1	
accode-privateservice	New	7.1	
accode-data	New	7.1	
accode-name	New	7.1	
accode-index	New	7.1	
nas-private	New	7.1	
acw-retain-lock	New	7.1	
expire-call-tout	New	7.1	Replaces call-delete-timeout.
	Removed	7.6	
retain-call-tout	New	7.1	Replaces call-delete-timeout.
convert-otherdn	New	7.1	
dn-for-undesired-calls	New	7.1	
accept-dn-type	New	7.2	
default-dn-type	New	7.2	
dn-del-mode	New	7.2	

Table 60: Option Modifications in T-Server for Siemens Hicom 300/HiPath 4000 CSTA I (Continued)

Option Name	Type of Change	Occurred in Release #	Details
compatibility	New	7.2	
emulate-login	New	7.5	
emulated-login-state	New	7.5	
sync-emu-agent	New	7.5	
untimed-wrap-up-value	New	7.5	
backwds-compat-acw-behavior	New	7.5	
override-switch-acw	New	7.5	
dial-separator	New	7.5	
agent-group	New	7.5	
timed-cwk-in-idle	See Details	7.5	Renamed to <code>timed-acw-in-idle</code> . Old name still available as an alias.
cwk-in-idle-force-ready	See Details	7.5	Renamed to <code>acw-in-idle-force-ready</code> . Old name still available as an alias.
notrdy-bsns-call-force-rdy	Removed	7.5	
consult-supervised-rt	See Details	7.5	Default value changed to <code>false</code> .
clid-withheld-name	New	7.6	
nas-indication	New	7.6	
wrap-up-threshold	New	7.6	
Application-Level Options > Link-Control Section			
The section name changed from the <code>CTI-Link</code> section to the <code>Link-control</code> section.			
CTI-Link Section	See Details	7.1	Renamed to the <code>Link-control</code> section.
protocol	Removed	7.1	
restart-cleanup-limit	New	7.1	
restart-cleanup-dly	New	7.1	
quiet-cleanup	New	7.1	

Table 60: Option Modifications in T-Server for Siemens Hicom 300/HiPath 4000 CSTA I (Continued)

Option Name	Type of Change	Occurred in Release #	Details
quiet-startup	New	7.1	
rq-expire-tout	New	7.1	Replaces request-timeout.
call-rq-gap	New	7.1	
rq-gap	New	7.1	
kpl-interval	New	7.1	Replaces link-keepalive-counter.
kpl-tolerance	New	7.1	Replaces link-keepalive-counter.
reg-interval	New	7.1	
acse-enable	New	7.1	
ha-sync-dly-lnk-conn	New	7.1	
max-outstanding	New	7.1	
reg-silent	See Details	7.5	Default value changed to true.
kpl-loss-rate	New	7.6	
Application-Level Options > Switch-Specific Type Section (new in 7.2)			
extension	New	7.2	
acd-queue	New	7.2	
routing-point	New	7.2	
routing-queue	New	7.2	
Agent Login-Level and DN-Level Options > TServer Section			
no-answer-timeout	New	7.1	
no-answer-overflow	New	7.1	
no-answer-action	New	7.1	

T-Server for Siemens HiPath DX

Table 61 shows the modifications made to switch-specific options for T-Server for Siemens HiPath DX when migrating to its latest release.

Table 61: Option Modifications for T-Server for Siemens HiPath DX

Option Name	Type of Change	Occurred in Release #	Details
Application-Level Options > TServer Section			
agent-no-answer-timeout	New	6.5.2	Default value: 15
	Modified	7.0	
agent-no-answer-overflow	New	6.5.2	No default value
	Modified	7.0	
agent-no-answer-action	New	6.5.2	No default value
	Modified	7.0	
agent-strict-id	New	6.5.1	Default value: false
wrap-up-time	New	6.5.1	Default value: 0
legal-guard-time	New	6.5.1	Default value: 0
timed-cwk-in-idle	New	6.5.1	Default value: true
cwk-in-idle-force-ready	New	6.5.1	Default value: true
inbound-bsns-calls	New	6.5.1	Default value: false
outbound-bsns-calls	New	6.5.1	Default value: false
shutdown-limit	Removed	6.5.1	
notrdy-bsns-cl-force-rdy	New	7.0	Default value: false
prd-dist-call-ans-time	New	7.0	Default value: 0
max-pred-req-delay	New	7.0	Default value: 3
extn-no-answer-timeout	New	7.0	Default value: 15
extn-no-answer-overflow	New	7.0	No default value
posn-no-answer-timeout	New	7.0	Default value: 15
posn-no-answer-overflow	New	7.0	No default value

Table 61: Option Modifications for T-Server for Siemens HiPath DX (Continued)

Option Name	Type of Change	Occurred in Release #	Details
supervised-route-timeout	New	7.0	No default value
inherit-bsns-type	New	7.0.2	
accept-dn-type	New	7.2	
default-dn-type	New	7.2	
dn-del-mode	See Details	7.2	Replaces dev-del-mode
Application-Level Options > CTI-Link Section			
manual-in	Removed	6.1	
use-switch-logins	Removed	6.1	
application-name	New	6.1	Default value: GCTI T-Server
hd-login-mode	New	6.1	Default value: agent
hd-logout-mode	New	6.1	Default value: agent
accode-privateservice	New	6.5.1	Default value: false
accode-udata	New	6.5.1	Default value: false
accode-agent	New	6.5.1	Default value: false
acw-retain-call	New	6.5.1	Default value: false
accode-use-rsn	New	6.5.2	Default value: false
trunk-map-mode	New	6.5.2	Default value: standard
reroute-gap	Removed	6.5.2	Default value: 300
strict-routing	New	6.5.3	Default value: true
host link-host	Modified	7.0	Renamed from link-host to hostname. You can still use previous name as an alias. New value: No default value Old value removed in 6.5.3: localhost

Table 61: Option Modifications for T-Server for Siemens HiPath DX (Continued)

Option Name	Type of Change	Occurred in Release #	Details
port link-port	Modified	7.0	Renamed from link-port to port in 7.0. New default value: 18544 Old default value: 20000
rq-gap	New	6.1	
	New default value	7.0	New default value: 0 Old default value: 10
use-routing use-native-routing	New	6.1	
	Modified	7.0	Renamed to use-native-routing. Default value: true
max-outstanding	New	6.1	
	New default value	7.0	New default value: 100 Old default value: 1
walk-away-bck-compat	New	7.0	Default value: true
call-rq-gap	New	7.0.2	
call-max-outstanding	New	7.0.2	
reg-delay	New	7.2	
reg-silent	New	7.2	
Agent Login-Level and DN-Level Options > TServer Section			
no-answer-timeout	New	7.0	Default value: Same as value in corresponding global option
no-answer-overflow	New	7.0	No default value
no-answer-action	New	7.0	No default value

T-Server for Siemens HiPath 3000 CSTA III

Table 62 shows the modifications made to switch-specific options for the T-Server for Siemens HiPath 3000 CSTA III when migrating to its latest release.

Table 62: Option Modifications in T-Server for Siemens HiPath 3000 CSTA III

Option Name	Type of Change	Occurred in Release #	Details
Application-Level Options > TServer Section			
internal-bsns-calls	New	7.1	
unknown-bsns-calls	New	7.1	
nas-private	New	7.1	
recall-no-answer-timeout	New	7.1	
convert-other-dn	New	7.1	
dn-for-undesired-calls	New	7.1	
callback-dn	New	7.1	
unknown-xfer-merge-udata	New	7.1	
correct-connid	New	7.1	
correct-rqid	New	7.1	
expire-call-tout	See details	7.1	Moved to the T-Server section and renamed from <code>expire-call-tmout</code> .
retain-call-tout	See details	7.1	Moved to the T-Server section and renamed from <code>retain-call-tmout</code> .
Application-Level Options > Link-Control Section			
The section name changed from the CTI-Link section to the <code>link-control</code> section.			
CTI-Link Section	See Details	7.1	Renamed to the <code>link-control</code> section.
quiet-cleanup	New	7.1	
quiet-startup	New	7.1	
restart-cleanup-dly	New	7.1	
ha-sync-dly-lnk-conn	New	7.1	

T-Server for Siemens HiPath 4000 CSTA III

Table 63 shows the modifications made to switch-specific options for the T-Server for Siemens HiPath 4000 CSTA III when migrating to its latest release.

Table 63: Option Modifications in T-Server for Siemens HiPath 4000 CSTA III

Option Name	Type of Change	Occurred in Release #	Details
Application-Level Options > TServer Section			
agent-no-answer-timeout	Modified	7.0	
agent-no-answer-overflow	Modified	7.0	
agent-no-answer-action	Modified	7.0	
notrdy-bsns-cl-force-rdy	New	7.0	
	Removed	7.5	
max-pred-req-delay	New	7.0	
extn-no-answer-timeout	New	7.0	
extn-no-answer-overflow	New	7.0	
posn-no-answer-timeout	New	7.0	
posn-no-answer-overflow	New	7.0	
agent-dev-check	New	7.0.2	
	Removed	7.1	
inherit-bsns-type	New	7.0.2	
accode-use-uevent	New	7.0.2	
	Removed	7.1	
accode-use-rsn	New	7.0.2	
	Removed	7.1	
accode-agent	New	7.0.2	
acw-retain-call	New	7.0.2	
accode-private-service	New	7.0.2	

Table 63: Option Modifications in T-Server for Siemens HiPath 4000 CSTA III (Continued)

Option Name	Type of Change	Occurred in Release #	Details
accode-data	New	7.0.2	
accode-name	New	7.0.2	
dtmf-digit-length	See Details	7.1	Moved to Tserver section.
internal-bsns-calls	New	7.1	
unknown-bsns-calls	New	7.1	
unknown-xfer-merge-udata	New	7.1	
nas-private	New	7.1	
recall-no-answer-timeout	New	7.1	
accode-index	New	7.1	
acw-retain-lock	New	7.1	
correct-connid	New	7.1	
correct-rqid	New	7.1	
pend-state-sync-tout	New	7.1	
callback-dn	New	7.1	
convert-otherdn	New	7.1	
dn-for-undesired-calls	New	7.1	
agent-clean-login	New	7.1	
retain-call-tout (retain-call-tmout)	See Details	7.1	Moved to the TServer section and renamed from retain-call-tmout. You can still use the previous name as an alias.
expire-call-tout (expire-call-tmout)	See Details	7.1	Moved to the TServer section and renamed from expire-call-tmout in 7.1. You can still use the previous name as an alias.
	Removed	7.6	
uui-as-text	See Details	7.1	Moved from the link-control section.

Table 63: Option Modifications in T-Server for Siemens HiPath 4000 CSTA III (Continued)

Option Name	Type of Change	Occurred in Release #	Details
transfer-timer	See Details	7.1	Moved from the link-control section.
	See Details	7.5	Upper limit of value range increased to 10000.
accept-dn-type	New	7.2	
default-dn-type	New	7.2	
dn-del-mode	New	7.2	
heartbeat-appname	New	7.2	
heartbeat-overflow	New	7.2	
emulate-login	New	7.5	
emulated-login-state	New	7.5	
agent-group	New	7.5	
sync-emu-agent	New	7.5	
	Removed	8.0	
dial-separator	New	7.5	
untimed-wrap-up-value	New	7.5	
backwds-compat-acw-behavior	New	7.5	
override-switch-acw	New	7.5	
timed-cwk-in-idle	See Details	7.5	Renamed to <code>timed-acw-in-idle</code> . You can still use the old name as an alias.
cwk-in-idle-force-ready	See Details	7.5	Renamed to <code>acw-in-idle-force-ready</code> . You can still use the old name as an alias.
consult-supervisrd-rt	See Details	7.5	Default value changed to <code>false</code> .
legal-guard-time	See Details	7.5	Upper limit of value range increased to 30.
clid-withheld-name	New	7.6	

Table 63: Option Modifications in T-Server for Siemens HiPath 4000 CSTA III (Continued)

Option Name	Type of Change	Occurred in Release #	Details
wrap-up-threshold	New	7.6	
nas-indication	New	7.6	
rtmem-divert-tout	New	7.6	
vto-onhook-dly	New	7.6	
auto-reconnect-on-fail	New	7.6	
sync-emu-acw	New	8.0	
agent-only-private-calls	New	8.0	
agent-logout-on-unreg	New	8.0	
agent-logout-reassoc	New	8.0	
agent-emu-login-on-call	New	8.0	
bsns-call-type	New	8.0	
call-type-by-dn	New	8.0	
releasing-party-report	New	8.0	
route-failure-alarm-high-wm	New	8.0	
route-failure-alarm-low-wm	New	8.0	
route-failure-alarm-period	New	8.0	
agent-strict-id	New value added	8.0	New value passwd added.
Application-Level Options > Link-Control Section			
The section name changed from the CTI-Link section to the link-control section.			
CTI-Link Section	See Details	7.1	Renamed to the link-control section.
hostname host	Modified	7.0.2	Name changed from host to hostname. You can still use the previous name as an alias. Default value changed to callbridge in 7.0.
call-rq-gap	New	7.0.2	

Table 63: Option Modifications in T-Server for Siemens HiPath 4000 CSTA III (Continued)

Option Name	Type of Change	Occurred in Release #	Details
kpl-interval	New	7.0	
kpl-tolerance	New	7.0	
max-outstanding	New	7.0	
rq-gap	New	7.0	
ha-sync-dly-lnk-conn	New	7.1	
restart-cleanup-limit	New	7.1	
	Modified	8.0	New default value: 0 Old default value: 10
restart-cleanup-dly	New	7.1	
quiet-cleanup	New	7.1	
quiet-startup	New	7.1	
retain-call-tout retain-call-tmout	See Details	7.1	Renamed from <code>retain-call-tmout</code> . Moved to the TServer section.
expire-call-tout expire-call-tmout	See Details	7.1	Renamed from <code>expire-call-tmout</code> . Moved to the TServer section
rq-expire-tout rq-expire-tmout	Modified	7.1	Renamed from <code>rq-expire-tmout</code> . You can still use the previous name as an alias.
reg-delay	New	7.2	
reg-silent	New	7.2	
	Modified	7.5	Default value change to true.
kpl-loss-rate	New	7.6	
link-alarm-high	New	8.0	
link-alarm-low	New	8.0	
use-link-bandwidth	New	8.0	
rq-conflict-check	New	8.0	

Table 63: Option Modifications in T-Server for Siemens HiPath 4000 CSTA III (Continued)

Option Name	Type of Change	Occurred in Release #	Details
device-rq-gap	New	8.0	
Application-Level Options > Switch-Specific Type Section (new in 7.2)			
extension	New	7.2	
acd-queue	New	7.2	
routing-point	New	7.2	
routing-queue	New	7.2	
Agent Login-Level and DN-Level Options > TServer Section			
no-answer-timeout	New	7.0	
no-answer-overflow	New	7.0	
no-answer-action	New.	7.0	

T-Server for Symposium Call Center Server

Starting with release 7.1, the functionality of Meridian I and Symposium Call Center Server T-Servers are combined into one T-Server. See “T-Server for Nortel Communication Server 1000 with SCCS/MLS” on [page 376](#).

T-Server for Tadiran Coral

[Table 64](#) shows the modifications made to switch-specific options for T-Server for Tadiran Coral when migrating to its latest release.

Table 64: Option Modifications in T-Server for Tadiran Coral

Option Name	Type of Change	Occurred in Release #	Details
Application-Level Options > TServer Section			
wrap-up-time	New	6.5.1	
legal-guard-time	New	6.5.1	
timed-cwk-in-idle	New	6.5.1	
cwk-in-idle-force-ready	New	6.5.1	

Table 64: Option Modifications in T-Server for Tadiran Coral (Continued)

Option Name	Type of Change	Occurred in Release #	Details
inbound-bsns-calls	New	6.5.1	
outbound-bsns-calls	New	6.5.1	
shutdown-limit	Removed	6.5.2	
keep-alive-timeout	Removed	6.5.2	
alternate-expire-timeout	Removed	6.5.2	
vto-onhook-delay	New	6.5.2	
aport-onhook-delay	Modified	7.0	Renamed from <code>aport-onhook-delay</code> .
agent-no-answer-timeout	New	6.5.3	
	Modified	7.0	
agent-no-answer-overflow	New	6.5.3	
	Modified	7.0	
agent-no-answer-action	New	6.5.3	
	Modified	7.0	
notrdy-bsns-cl-force-rdy	New	7.0	
prd-dist-call-ans-time	New	7.0	
max-pred-req-delay	New	7.0	
extn-no-answer-timeout	New	7.0	
extn-no-answer-overflow	New	7.0	
posn-no-answer-timeout	New	7.0	
posn-no-answer-overflow	New	7.0	
supervised-route-timeout	New	7.0	
inherit-bsns-type	New	7.0.2	
Application-Level Options > CTI-Link Section			
max-queued	Removed	6.5.2	
kpl-interval	New	6.5.2	

Table 64: Option Modifications in T-Server for Tadiran Coral (Continued)

Option Name	Type of Change	Occurred in Release #	Details
kpl-tolerance	New	6.5.2	
reroute-gap	Removed	6.5.2	
reg-interval	New	7.0	
call-rq-gap	New	7.0.2	
call-max-outstanding	New	7.0.2	
rq-gap	Modified	7.0.2	Default value changed from 10 to 0.
host hostname	Modified	7.0.2	Named changed from host to hostname. You can still use the previous name as an alias.
Agent Login–Level and DN-Level Options > TServer Section			
no-answer-timeout	New	7.0	
no-answer-overflow	New	7.0	
no-answer-action	New	7.0	

T-Server for Teltronics 20-20

Table 65 shows the modifications made to switch-specific options for T-Server for Teltronics 20-20 when migrating to its latest release.

Table 65: Option Modifications in T-Server for Teltronics 20-20

Option Name	Type of Change	Occurred in Release #	Details
Application-Level Options > TServer Section			
default-destination	See Details	6.5.3	New default value: 9999
link-timeout	See Details	6.5	New default value: 1000
	See Details	6.5	New lower limit: 1000
tracking-timeout	See Details	6.5	New default value: 3000
channel-rq-timeout	See Details	6.5	New default value: 10
correct-connid	New	7.0.2	

Table 65: Option Modifications in T-Server for Teltronics 20-20 (Continued)

Option Name	Type of Change	Occurred in Release #	Details
Application-Level Options > UDP-Connection Section			
iface-address	New default value	6.5.3	New value: harr i shost
Application-Level Options > Switch Collect-and-Route Configuration Section			
hil-hold-invoke	New	6.5.2	Reserved for Genesys engineers until 7.0.200.05.

T-Server for Tenovis Integral 33/55

Table 66 shows the modifications made to switch-specific options for T-Server for Tenovis Integral 33/55 when migrating to its latest release.

Table 66: Option Modifications in T-Server for Tenovis Integral 33/55

Option Name	Type of Change	Occurred in Release #	Details
Application-Level Options > TServer Section			
wrap-up-time	New	6.5.1	
legal-guard-time	New	6.5.1	
timed-cwk-in-idle	New	6.5.1	
cwk-in-idle-force-ready	New	6.5.1	
inbound-bsns-calls	New	6.5.1	
outbound-bsns-calls	New	6.5.1	
agent-no-answer-timeout	New	6.5.2	
	Modified	7.0	
agent-no-answer-overflow	New	6.5.2	
	Modified	7.0	
agent-no-answer-action	New	6.5.2	
	Modified	7.0	

Table 66: Option Modifications in T-Server for Tenovis Integral 33/55 (Continued)

Option Name	Type of Change	Occurred in Release #	Details
agent-strict-id	New	6.5.2	
shutdown-limit	Removed	6.5.2	
agent-substitute	New	6.5.3	
prd-dist-ans-call-time	New	6.5.3	
supervised-route-timeout	New	6.5.3	
consult-supervised-rt	New	7.0	
vto-onhook-delay	New	7.0	
no-answer-action-dly	New	7.0	
notrdy-bsns-cl-force-rdy	New	7.0	
max-pred-req-delay	New	7.0	
extn-no-answer-timeout	New	7.0	
extn-no-answer-overflow	New	7.0	
posn-no-answer-timeout	New	7.0	
posn-no-answer-overflow	New	7.0	
inherit-bsns-type	New	7.0.2	
Application-Level Options > CTI-Link Section			
reroute-gap	Removed	6.5.2	
reg-interval	New	6.5.2	
expire-call-tmout	Units changed	6.5.3	New units: seconds Old units: minutes
cti-version	New	6.5.3	
wrapup-time (for real agents)	Removed	7.0	
hostname link-host	Modified	7.0.2	Name changed to hostname. You can still use the previous name as an alias.
port link-port	Modified	7.0.2	Name changed to port. You can still use the previous name as an alias.

Table 66: Option Modifications in T-Server for Tenovis Integral 33/55 (Continued)

Option Name	Type of Change	Occurred in Release #	Details
call-rq-gap	New	7.0.2	
call-max-outstanding	New	7.0.2	
Agent Login-Level and DN-Level Options > TServer Section			
no-answer-timeout	New	7.0	
no-answer-overflow	New	7.0	
no-answer-action	New	7.0	

Network T-Server for AT&T

[Table 67](#) shows the modifications made to switch-specific options for Network T-Server for AT&T, when migrating to its latest release.

Table 67: Option Modifications in Network T-Server for AT&T

Option Name	Type of Change	Occurred in Release #	Details
pgf-debug Section			
pgf-debug	New	7.0	Section pgf-debug has been added.
debug	New	7.0	

Network T-Server for Concert

[Table 68](#) shows the modifications made to T-Server-specific options for Network T-Server for Concert, when migrating to its latest release.

Table 68: Option Modifications in Network T-Server for Concert

Option Name	Type of Change	Occurred in Release #	Details
TServer Section			
log-file-name	Removed	7.0	
log-file-size	Removed	7.0	
log-remove-old-files	Removed	7.0	

Table 68: Option Modifications in Network T-Server for Concert (Continued)

Option Name	Type of Change	Occurred in Release #	Details
log-check-interval	Removed	7.0	
log-buffering	Removed	7.0	
remote-agent-route-support	Removed	7.0	
use-purge-by-time	Removed	7.0	
max-response-wait	Removed	7.0	
def-route-type	Moved	7.0	This option moved to section crp.
def-label	Moved	7.0	This option moved to section crp.
use-purge-by-size	Moved	7.0	This option moved to section crp.
max-queue-size	Moved	7.0	This option moved to section crp.
request-queue-size	Removed	7.0	
queue-check-time-msec	Removed	7.0	
min-dialed-len-national	Moved	7.0	This option moved to section crp.
max-dialed-len-national	Moved	7.0	This option moved to section crp.
min-dialed-len-international	Moved	7.0	This option moved to section crp.
max-dialed-len-international	Moved	7.0	This option moved to section crp.
min-ani-len-national	Moved	7.0	This option moved to section crp.
max-ani-len-national	Moved	7.0	This option moved to section crp.
min-ani-len-international	Moved	7.0	This option moved to section crp.
max-ani-len-international	Moved	7.0	This option moved to section crp.
min-ced-len	Moved	7.0	This option moved to section crp.
max-ced-len	Moved	7.0	This option moved to section crp.
ss7-tcap-impl-name	Removed	7.0	
dgms-max-dialogs	Removed	7.0	
dgms-local-ssn	Removed	7.0	
dgms-node-name	Removed	7.0	

Table 68: Option Modifications in Network T-Server for Concert (Continued)

Option Name	Type of Change	Occurred in Release #	Details
dgms-logical-name	Removed	7.0	
hp-ss7-ssn	Removed	7.0	Replaced with ssn and included in section OpenCall.
hp-ss7-name	Removed	7.0	Replaced with ss7Name and included in section OpenCall.
hp-appl-id	Removed	7.0	Replaced with appId and included in section OpenCall.
hp-inst-id	Removed	7.0	Replaced with instId and included in section OpenCall.
hp-tcap-timeout-sec	Removed	7.0	
ss7-tcap-impl-name	Removed	7.0	
AsnSap Section			
AsnSap	New	7.0	The section AsnSap has been added.
type-table-file	New	7.0	
codec-data-location-specified	New	7.0	
encode-module-name	New	7.0	
encode-type-name	New	7.0	
decode-module-name	New	7.0	
decode-type-name	New	7.0	
data-location	New	7.0	
property-map-location	New	7.0	
pgf Section			
pgf	New	7.0	The section pgf has been added.
ptc-file	New	7.0	
pgf-debug Section			
pgf-debug	New	7.0	The section pgf-debug has been added.

Table 68: Option Modifications in Network T-Server for Concert (Continued)

Option Name	Type of Change	Occurred in Release #	Details
debug	New	7.0	
crp Section			
crp	New	7.0	The section crp has been added.
def-route-type	New	7.0	
Timers Section			
Timers	New	7.0	The section Timers has been added.
Call Timeout	New	7.0	
DecSs7 Section			
DecSs7	New	7.0	The section DecSs7 has been added.
tcap-allow-multi-comp	New	7.0	
NMS Section			
NMS	New	7.0	The section NMS has been added.
serviceName	New	7.0	
serviceManager	New	7.0	
paramFlags	New	7.0	
traceFlags	New	7.0	
boardNum	New	7.0	
appid	New	7.0	
sapid	New	7.0	
ssn	New	7.0	
ansi_param_container	New	7.0	
switchover	New	7.0	
tcap-allow-multi-comp	New	7.0	
OpenCall Section			
OpenCall	New	7.0	Section OpenCall has been added.

Table 68: Option Modifications in Network T-Server for Concert (Continued)

Option Name	Type of Change	Occurred in Release #	Details
ssn	New	7.0	Replaces hp-ss7-ssn.
ss7Name	New	7.0	Replaces hp-ss7-name.
sccpServiceType	New	7.0	
appId	New	7.0	Replaces hp-app l - i d.
instId	New	7.0	Replaces hp - i n s t - i d.
openTimeout	New	7.0	
reconnectTimeout	New	7.0	
tcap-allow-multi-comp	New	7.0	

Network T-Server for CRSP

[Table 69](#) shows the modifications made to switch-specific options for Network T-Server for CRSP, when migrating to its latest release.

Table 69: Option Modifications in Network T-Server for CRSP

Option Name	Type of Change	Occurred in Release #	Details
CRSP Section			
allow_pstn_consult	New	7.1	
Timers Section			
Session Timeout	See Details	7.6	This option is undocumented in previous versions.

Network T-Server for DTAG

Table 70 shows the modifications made to switch-specific options for Network T-Server for DTAG, when migrating to its latest release.

Table 70: Option Modifications in Network T-Server for DTAG

Option Name	Type of Change	Occurred in Release #	Details
service-%d Section			
service-%d	New	6.5.3	The section <code>service-%d</code> has been added.
service-indicator	New	6.5.3	
max-length	New	6.5.3	
ClearANIfCLIR	Modified	7.2	New valid values: <code>true</code> , <code>false</code> Old valid values: <code>0</code> , <code>1</code>
add-zeroes	Modified	7.2	New valid values: <code>true</code> , <code>false</code> Old valid values: <code>0</code> , <code>1</code> Option name spelling corrected Old name: <code>add-zeros</code> New name: <code>add-zeroes</code>
reroute-by-scp-for-announcement	Modified	7.2	New valid values: <code>true</code> , <code>false</code> Old valid values: <code>0</code> , <code>1</code>
reroute-by-scp-for-destination	Modified	7.2	New valid values: <code>true</code> , <code>false</code> Old valid values: <code>0</code> , <code>1</code>
TServer Section			
scp-<n>-name	See Details	7.6	This option is undocumented in previous versions.
service-<n>	See Details	7.6	This option is undocumented in previous versions.

Network T-Server for GenSpec

Table 71 shows the modifications made to switch-specific options for Network T-Server for GenSpec when migrating to its latest release.

Table 71: Option Modifications in Network T-Server for GenSpec

Option Name	Type of Change	Occurred in Release #	Details
Tcap Tcl Network Interface-specific Section			
asn-type-table-file	Removed	6.5.1	Replaced with <code>type-table-file</code> and included in section <code>AsnSap</code> .
tcap-impl-name	Removed	6.5.1	
bcd-star	Removed	6.5.1	Replaced with <code>bcd-conversion</code> and included in section <code>pgf</code> . See also <code>bcd-pound</code> .
bcd-pound	Removed	6.5.1	Replaced with <code>bcd-conversion</code> and included in section <code>pgf</code> . See also <code>bcd-star</code> .
TclServer-specific Section			
TcapTclNetworkInterface_specific	Removed	6.5.1	
tcl-config-file	Removed	6.5.1	Replaced with <code>ptc-file</code> and included in section <code>pgf</code> .
IWF_specific Section			
IWF_specific	Removed	6.5.1	Replaced with the GenSpec section. All options are unchanged.
FlowControl_State	Moved	6.5.1	Moved to section GenSpec.
SendRouteResponseOnTimeout	Moved	6.5.1	Moved to section GenSpec.
WaitingForRouter_Timeout	Moved	6.5.1	Moved to section GenSpec.
WaitingForRouter_AfterTreatmentEnd_Timeout	Moved	6.5.1	Moved to section GenSpec.
WaitingForSCP_TreatmentApplied_Timeout	Moved	6.5.1	Moved to section GenSpec.

Table 71: Option Modifications in Network T-Server for GenSpec (Continued)

Option Name	Type of Change	Occurred in Release #	Details
WaitingForSCP_TreatmentEnd_Timeout	Moved	6.5.1	Moved to section GenSpec.
WaitingForSCP_RouteUsed_Timeout	Moved	6.5.1	Moved to section GenSpec.
WaitingForSCP_EndCall_Timeout	Moved	6.5.1	Moved to section GenSpec.
gdi_specific Section			
gdi_specific	Removed	6.5.1	This section has been renamed g l i . All options are renamed from a g d i prefix to a g l i prefix. For example, g d i -mode is now g l i -mode.
gdi-mode	Removed	6.5.1	
gdi-keep-alive-interval	Removed	6.5.1	
gdi-keep-alive-tries	Removed	6.5.1	
gdi-reconnect-delay	Removed	6.5.1	
gdi-link-proving-delay	Removed	6.5.1	
gdi_client_specific Section			
gdi_client_specific	Removed	6.5.1	
gdi-client-mode	Removed	6.5.1	
gdi-n-clients	Removed	6.5.1	
gdi-client-address	Removed	6.5.1	
gdi-connection-list	Removed	6.5.1	
gdi_server_specific Section			
gdi_server_specific	Removed	6.5.1	This section has been renamed g l i _server . All options are renamed from a g d i prefix to a g l i prefix. For example, g d i -server-mode is now g l i -server-mode.
gdi-server-mode	Removed	6.5.1	

Table 71: Option Modifications in Network T-Server for GenSpec (Continued)

Option Name	Type of Change	Occurred in Release #	Details
gdi-n-servers	Removed	6.5.1	
gdi-server-address	Removed	6.5.1	
gdi-client-list	Removed	6.5.1	
AsnSap Section			
encode-module-name	New	6.5.1	
	Removed	8.0	
encode-type-name	New	6.5.1	
	Removed	8.0	
decode-module-name	New	6.5.1	
	Removed	8.0	
decode-type-name	New	6.5.1	
	Removed	8.0	
type-table-file	New	6.5.1	
	Removed	8.0	
codec-data-location-specified	Removed	8.0	
data-location	Removed	8.0	
property-map-location	Removed	8.0	
pgf Section			
ptc-file	New	6.5.1	Replaces tcl-config-file and included in section pgf.
	Removed	8.0	
watermark	New	7.0	
	Moved	8.0	Moved to section TServer.

Table 71: Option Modifications in Network T-Server for GenSpec (Continued)

Option Name	Type of Change	Occurred in Release #	Details
GenSpec Section			
GenSpec section	New	6.5.1	Replaces the <code>IWF_spec i f i c</code> section. All options are moved from there to here and remain unchanged. See <code>IWF_spec i f i c</code> section.
CallMonitoring_Events	New	7.0	
	Removed	7.1	
FlowControlState	Renamed	7.1	Renamed from <code>F l o w C o n t r o l _ S t a t e</code> .
FlowControl_State	See Details	8.0	Moved to section TServer. Renamed <code>f l o w - c o n t r o l - s t a t e</code> .
DNISubsetLength	Renamed	7.1	Renamed from <code>D N I S _ S u b s e t _ L e n g t h</code> .
DNIS_Subset_Length			
LoadBalanceOutboundLinks	New	7.1	
	See Details	8.0	Moved to section TServer. Renamed <code>l o a d - b a l a n c e - o u t b o u n d - l i n k s</code> .
MaxTreatmentError	New	7.1	
	See Details	8.0	Moved to section TServer. Renamed <code>m a x - t r e a t m e n t - e r r o r</code> .
NegInvokeIds	New	7.1	
	See Details	8.0	Moved to section TServer. Renamed <code>n e g - i n v o k e - i d s</code> .
AllowPstnConsult	New	7.1	
	See Details	8.0	Moved to section TServer. Renamed <code>a l l o w - p s t n - c o n s u l t</code> .
SendRouteRequestOn-Timeout	Modified	7.2	New valid values: true, false Old valid values: yes, no
	See Details	8.0	Moved to section TServer. Renamed <code>s e n d - r o u t e - r e s p o n s e - o n - t i m e o u t</code> .

Table 71: Option Modifications in Network T-Server for GenSpec (Continued)

Option Name	Type of Change	Occurred in Release #	Details
FlowControlWaitForLogin	New	7.6	
	See Details	8.0	Moved to section TServer. Renamed <code>flow-control-wait-for-login</code> .
gli Section			
gli section	New	6.5.1	This section has been renamed <code>gli</code> from the previous name of <code>gdi_specific</code> . All options are renamed from a <code>gdi</code> prefix to a <code>gli</code> prefix. For example, <code>gdi-mode</code> is now <code>gli-mode</code> .
gli-mode	New	6.5.1	
	Removed	8.0	
gli-keep-alive-interval	New	6.5.1	
	New default value	6.5.1	New default value: <code>20</code> Old default value: <code>-1</code>
gli-keep-alive-tries	New	6.5.1	
	New default value	6.5.1	New default value: <code>20</code> Old default value: <code>-1</code>
gli-reconnect-delay	New	6.5.1	
gli-link-proving-delay	New	6.5.1	
	Obsolete	7.5	
	Removed	8.0	
gli-queue-max-timeout	New	8.0	
gli_server Section			
gli-server-mode	New	6.5.1	
	Removed	8.0	
gli-n-servers	New	6.5.1	
	Obsolete	7.5	
	Removed	8.0	

Table 71: Option Modifications in Network T-Server for GenSpec (Continued)

Option Name	Type of Change	Occurred in Release #	Details
gli-server-address	New	6.5.1	
gli-client-list	New	6.5.1	
gli-circuit-failover	New	6.5.1	
gli_server_group_<n> Section			
gli-tls-cert	New	7.5	
gli-tls-cert-key	New	7.5	
gli-trusted-ca	New	7.5	
RerouteSap Section			
RerouteSap section	New	6.5.1	
	Removed	7.1	
reroute-info-path	New	6.5.1	
	Removed	7.1	
debug	New	6.5.1	
	Removed	7.1	
pgf-debug Section			
pgf-debug section	New	7.0	The section pgf-debug has been added.
	See Details	7.1	Not to be documented. For internal use only.
debug	New	7.0	
Timers Section			
DefaultRouteTimeout WaitingForRouter_Timeout	See Details	7.1	Renamed from WaitingForRouter_Timeout. Moved from the GenSpec section.
	Removed	8.0	Replaced by urs-response-timeout option.

Table 71: Option Modifications in Network T-Server for GenSpec (Continued)

Option Name	Type of Change	Occurred in Release #	Details
TreatmentRouteTimeout WaitingForRouter_After TreatmentEnd_Timeout	See Details	7.1	Renamed from WaitingForRouter_After TreatmentEnd_Timeout. Moved from the GenSpec section.
	Removed	8.0	Replaced by <code>urs-response-timeout</code> option.
TreatmentAppliedTimeout WaitingForSCP_Treatment Applied_Timeout	See Details	7.1	Renamed from WaitingForSCP_Treatment Applied_Timeout. Moved from the GenSpec section.
	See Details	8.0	Moved to section TServer. Renamed <code>treatment-applied-timeout</code> .
TreatmentEndTimeout WaitingFor SCP_ TreatmentEnd_Timeout	See Details	7.1	Renamed from WaitingForSCP_Treatment End_Timeout. Moved from the GenSpec section.
	Removed	8.0	Obsolete
RouteUsedTimeout WaitingForSCP_RouteUsed_ Timeout	See Details	7.1	Renamed from WaitingForSCP_RouteUsed_Timeout. Moved from the GenSpec section.
	Removed	8.0	Obsolete
EndCallTimeout WaitingForSCP_EndCall_ Timeout	See Details	7.1	Renamed from WaitingForSCP_EndCall_Timeout. Moved from the GenSpec section.
	See Details	8.0	Moved to section TServer. Renamed <code>end-call-timeout</code> .
AsyncRequestTimeout AsyncRequest_Timeout	See Details	7.1	Renamed from AsyncRequest_Timeout. Moved from the GenSpec section.
	Removed	8.0	Obsolete
OutboundCallTimeout	New	7.1	
	Removed	8.0	Obsolete

Table 71: Option Modifications in Network T-Server for GenSpec (Continued)

Option Name	Type of Change	Occurred in Release #	Details
OutboundRerouteTimeout	New	7.1	
	Removed	8.0	Obsolete
RouteRequestTimeout	New	7.1	
	Modified	7.2	Corrected default value New value: 1 min Old value: 1 m
	Removed	8.0	Obsolete
TServer Section			
gli_server_group_<n>	See Details	7.6	This option is undocumented in previous versions.
abort-calls-on-link-failure	New	8.0	
allow-pstn-consult	See Details	8.0	Moved from GenSpec section. Renamed from AllowPstnConsult.
flow-control-state	See Details	8.0	Moved from GenSpec section. Renamed from FlowControlState.
flow-control-wait-for-login	See Details	8.0	Moved from GenSpec section. Renamed from FlowControlWaitForLogin.
bcd-conversion	Moved	8.0	Moved from pgf section.
bcd-order	Moved	8.0	Moved from pgf section.
dnis-subset-length	See Details	8.0	Moved from GenSpec section. Renamed from DNISubsetLength.
end-call-timeout	See Details	8.0	Moved from Timers section. Renamed from EndCallTimeout.
event-abandoned-on-error	See Details	8.0	Moved from GenSpec section. Renamed from EventAbandonedOnError.
load-balance-outbound-links	See Details	8.0	Moved from GenSpec section. Renamed from LoadBalanceOutboundLinks.

Table 71: Option Modifications in Network T-Server for GenSpec (Continued)

Option Name	Type of Change	Occurred in Release #	Details
max-treatment-error	See Details	8.0	Moved from GenSpec section. Renamed from MaxTreatmentError.
neg-invoke-ids	See Details	8.0	Moved from GenSpec section. Renamed from NegInvokeIds.
network-response-timeout	New	8.0	
send-extension-data-to-scp	New	8.0	
send-route-response-on-timeout	See Details	8.0	Moved from GenSpec section. Renamed from SendRouteResponseOnTimeout.
switch-response-timeout	New	8.0	
treatment-applied-timeout	See Details	8.0	Moved from Timers section. Renamed from TreatmentAppliedTimeout.
treatment-state-timeout	New	8.0	
urs-response-timeout	New	8.0	
watermark	Moved	8.0	Moved from pgf section.

Network T-Server for ISCP

[Table 72](#) shows the modifications made to T-Server-specific options for Network T-Server for ISCP, when migrating to its latest release.

Table 72: Option Modifications in Network T-Server for ISCP

Option Name	Type of Change	Occurred in Release #	Details
pgf-debug Section			
pgf-debug	New	7.0	The section pgf-debug has been added.
debug	New	7.0	
AsnSap Section			
type-table-file	Modified	8.0	Default Value changed from ldap.tt to tserver.tt.

Table 72: Option Modifications in Network T-Server for ISCP (Continued)

Option Name	Type of Change	Occurred in Release #	Details
tcp Section			
tcp-len-trim	New	8.0	

Network T-Server for NGSN

Table 73 shows the modifications made to T-Server-specific options for Network T-Server for NGSN, when migrating to its latest release.

Table 73: Option Modifications in Network T-Server for NGSN

Option Name	Type of Change	Occurred in Release #	Details
pgf-debug Section			
pgf-debug	New	7.0	The section pgf-debug has been added.
debug	New	7.0	
allow_pstn_consult	New	7.1	
gli Section			
gli-link-proving-delay	Obsolete	7.5	
gli_server Section			
gli-n-servers	Obsolete	7.5	
gli_server_group_<n> Section			
gli-tls-cert	New	7.5	
gli-tls-cert-key	New	7.5	
gli-trusted-ca	New	7.5	
ASNSap Section			
codec-data-location-specified	Removed	7.6	
data-location	Removed	7.6	
property-map-location	Removed	7.6	

Table 73: Option Modifications in Network T-Server for NGSN (Continued)

Option Name	Type of Change	Occurred in Release #	Details
TServer Section			
gli_server_group_<n>	See Details	7.6	This option is undocumented in previous versions.
Timers Section			
RouteUsedTimeout	New	7.6	

Network T-Server for OPSI

[Table 74](#) shows the modifications made to switch-specific options for Network T-Server for OPSI, when migrating to its latest release.

Table 74: Option Modifications in Network T-Server for OPSI

Option Name	Type of Change	Occurred in Release #	Details
pgf-debug Section			
pgf-debug	New	7.0	The section pgf-debug has been added.
debug	New	7.0	

Network T-Server for SR3511

[Table 75](#) shows the modifications made to switch-specific options for Network T-Server for SR3511, when migrating to its latest release.

Table 75: Option Modifications in Network T-Server for SR3511

Option Name	Type of Change	Occurred in Release #	Details
TServer Section			
ivr-max-response-wait	Modified	8.0	Default value changed from 0 to 3600.
router-max-response-wait	Modified	8.0	Default value changed from 0 to 10.
reconnect-attempt-period	Modified	8.0	Default value changed from 15 to 5.
no-error-is-success	Modified	8.0	Default value changed from 500 to 0.

Table 75: Option Modifications in Network T-Server for SR3511 (Continued)

Option Name	Type of Change	Occurred in Release #	Details
routing-point-call-model	Modified	8.0	Valid and default values changed to true, false from yes, no.
link-n-name	Modified	8.0	Default value changed from No default value to link-tcp.



Chapter

22 T-Server Migration Procedures

This chapter discusses the migration procedures for releases 6.x and 7.x to 8.0 and contains the following sections:

- [Migration from Previous Releases, page 429](#)
- [Deploying T-Server 8.x in 6.x Environment, page 432](#)
- [HA Environment Migration, page 434](#)

Migration from Previous Releases

This section describes the migration procedures for T-Server from pre-8.0 releases. It covers the following topics:

- [Prerequisites for a 8.0 Framework Environment, page 429](#)
- [T-Server Migration Procedures, page 430](#)
- [Known Migration Issues for Specific T-Servers, page 432](#)
- [Licensing Issues for T-Server 8.x in a 6.x Environment, page 432](#)

Prerequisites for a 8.0 Framework Environment

If you are migrating your entire existing Genesys Framework to the 8.0 release of Framework, you must upgrade your Configuration Layer components to 8.0 before you migrate your T-Servers. If you are only upgrading your T-Servers, there are no special steps you need to take with your existing Configuration Layer. In both scenarios, the steps for migrating T-Server are the same.

Licensing

Prior to migrating your T-Server, be aware that you need to take licensing issues into account. Starting with release 7.0, the licensing requirements for T-Server have changed from previous releases. Please refer to the *Genesys Licensing Guide* and your *T-Server Deployment Guide* for complete licensing information.

Starting with release 7.0, T-Servers refer to the license server for authentication. The new license server rules are described in the *Genesys Licensing Guide*.

Licensing Requirements for T-Server

The following are short descriptions of the issues you must consider when deploying your new licensing for T-Server:

- A stand-alone T-Server serving a single site requires licenses to register all DNs it monitors. Single-site licenses are also required for all Network T-Servers.
- T-Servers operating with the hot standby redundancy require a special CTI HA technical license, which allows for high-availability implementations in addition to regular T-Server licenses.
- T-Servers performing multi-site operations require licenses that allow for such operations in addition to regular T-Server licenses.
- Network T-Server for GenSpec has two new licensing requirements: NTS Deployment and IVR Treatment.

Licensing Prerequisites

Before starting your migration of T-Server:

1. Obtain appropriate license files for 8.0 T-Servers.
2. Install Licensing Manager.

Other Migration Information

Related migration information that may help you migrate T-Server is available elsewhere in this guide. See:

1. Chapter 2, “Licensing Migration,” on [page 41](#)
2. Framework migration information in Part Two of this guide
3. *Genesys 8 Interoperability Guide*
4. Information on upgrades to other prerequisite Genesys components

T-Server Migration Procedures

Use the following two sections to assist you in performing a basic upgrade to or rollback from pre-8.0 releases to 8.0 or rollback from release 8.0 to pre-8.0 releases of T-Server. For information about migrating the HA configurations, see “HA Environment Migration” on [page 434](#).

T-Server Upgrade Procedures

To Upgrade T-Server

Perform the following steps for each T-Server Application object whose data was converted from pre-8.0 releases of Configuration Database:

1. Store the existing configuration option settings in a *.cfg file using the Export utility in Configuration Manager. Preserve this *.cfg file in a secure location in case you need to rollback later. Refer to *Framework 8.0 Configuration Manager Help* for instructions on using the Export utility.
2. Install a physical T-Server 8.0 application. For installation instructions, refer to the *Framework 8.0 Deployment Guide*.
3. Verify the parameters on the Start Info tab of the T-Server Application object in Configuration Manager—the T-Server working directory, executable name, and command-line parameters.
4. Specify any new configuration options on the Options tab of the T-Server Application object in Configuration Manager. See your specific *T-Server Deployment Guide* for complete details on options. Also see “Configuration Options Common to All T-Servers” on [page 307](#) of this guide for notes on updates to options.
5. If you have not previously used the centralized-logging and alarm-signaling capabilities of the Management Layer, but would like to do so now, add a connection to Message Server on the Connections tab of the T-Server Application object in Configuration Manager.
6. If using Configuration Server Proxy for notifying this T-Server about configuration changes, add Configuration Server Proxy to the Connections tab of the T-Server Application object in Configuration Manager.

Refer to the “Start and Stop T-Server Components” chapter in your specific *T-Server 8.0 Deployment Guide* for startup instructions.

Note: Starting with release 7.6, the executable file for T-Server for Nortel Communication Server 2000/2100 renamed ncs2000_server.

For migration procedures in high-availability environment, see “HA Environment Migration” on [page 434](#).

T-Server Rollback Procedures

To Rollback to Earlier Version

If you must return to your pre-8.0 Genesys installation:

1. Import the *.cfg file that has your pre-8.0 T-Server configuration options to restore previously configured settings. Refer to *Framework 8.0 Configuration Manager Help* for instructions on using the Import utility.
2. Delete any new connections to server applications you have configured on the Connections tab of the T-Server Application object in Configuration Manager.

3. Uninstall T-Server 8.0.

Known Migration Issues for Specific T-Servers

T-Server for Alcatel 4200/OXO

The 7.6 release of T-Server for Alcatel A4200/OXO includes a large number of architecture, coding, and feature changes which make high availability between a 7.0 and a 7.6 T-Server unsupported.

Genesys therefore does not support any high-availability functionality where a 7.6 and a 7.0 T-Server are configured as a high-availability pair.

T-Server for Alcatel A4400/OXE

When migrating from releases 7.x to 8.x, note the following:

- When performing an in-service upgrade from pre-7.x releases to 8.0 and emulated agents are used in the environment, these agents must be logged out before switching over to the new T-Server, and then logged in again after the switchover.
- Genesys does not recommend performing an in-service downgrade (8.x to 7.x) in environments where emulated routing or outbound dialling using TMakePredictiveCall are used. The primary and backup T-Servers must both be of the same release family.

Deploying T-Server 8.x in 6.x Environment

T-Server 8.0 supports deployment into an environment that will continue to use 6.x, 7.1, 7.2, 7.5, and 7.6 Genesys components. The steps required for this type of deployment are the same as those you must take to install T-Server in a 8.0 environment. The differences in the mixed environment case determine how you must deploy your licensing for T-Server.

Note: If you are running your T-Servers in either hot or warm standby mode, then the primary and backup T-Servers must both be of the same release family.

Licensing Issues for T-Server 8.x in a 6.x Environment

While the steps for migrating T-Server to a 8.x or a mixed environment are generally the same, there are a few licensing issues that you need to consider for the mixed environment.

License Section in Options Tab

The License section in the Options tab of the T-Server Application object is not required for backward compatibility in the 6.x environment. However, in the event that you need to specify numbers of licenses, you may add that section. See the *Framework 8.0 Deployment Guide* for full details.

**To Deploy
Licensing for
T-Server**

There are two ways to deploy licensing for T-Server 8.x in a 6.x environment:

1. Use one License Manager (LM) 8.3 or higher for the whole environment
or
2. Use two separate LMs—one for 6.x applications and another one for 8.x applications. In this case, retain your existing 6.x license, and order 8.x licenses for the appropriate servers.

Note: Genesys 5.x and 6.x applications require FLEXm License Manager 6.1 or higher; Genesys 8.x applications require FLEXm License Manager 8.3 or higher; and only Genesys applications for RedHat Linux Enterprise require FLEXm License Manager 9.5.

If you choose option Number 1 above (use one LM 8.3), select one of the following procedures:

- a. Order T-Server 8.x licenses for the same host where your LM is running.
- b. Update the license file with the new features for your new T-Server.
- c. Stop the old LM and start LM 8.3.
- d. Install LM 8.3. Configure it in the same way you configured your previous LM, using the same port and license file.
- e. Install T-Server.
- f. Start T-Server.

or

- a. Order T-Server 8.x licenses for any other hosts where your LM 8.3 will be running.
- b. Install LM 8.3.
- c. Run LM 8.3 with the new license file (containing licenses for T-Server 8.x).
- d. Install T-Server.
- e. Start T-Server.

If you use two or more T-Servers, and these T-Servers share licenses, create a new section called `license` on the `Options` tab for each T-Server Application in Configuration Manager before you start the T-Servers. Configure the `license` section options before starting T-Server. See the *Genesys Licensing Guide* and “T-Server Common Configuration Options” section in your *T-Server 8.0 Deployment Guide* for information on configuring license options.

Note: Since licensing is based on DNs in use, be sure to configure in the Configuration Database all DNs that agents use (ACD Positions Extensions) and that T-Server should control.

HA Environment Migration

Depending on the switch type, one of the following cases will apply:

- T-Servers that do not use HA Proxies
- T-Servers that use HA Proxies in pre-8.0 and continue to use them in 8.0
- T-Servers that used HA Proxies in previous releases but no longer use them

Note: To verify if your T-Server still requires HA Proxy, refer to the switch-specific *T-Server Deployment Guide*.

T-Servers That Do Not Use HA Proxies

Starting with the backup T-Server, follow the upgrade steps described in “T-Server Migration Procedures” on [page 430](#) for each T-Server in the redundant pair. The migration will be completed once you have upgraded and restarted both the primary and backup T-Server.

T-Servers That Use HA Proxies

Starting with the backup T-Server, follow the upgrade steps described in “T-Server Migration Procedures” on [page 430](#) for each T-Server in the redundant pair. After this is done, upgrade your HA Proxy components. The T-Servers and HA Proxies must be of the same release family.

Notes: For T-Server for Nortel Communication Server 2000/2100 only.

- Before migrating from 6.x-7.1 to 7.2 or later, you need to stop both primary and backup T-Servers.
 - Starting with release 7.6, T-Server supports 7.5 HA Proxy.
-

T-Servers That Used HA Proxies in Previous Releases but No Longer Use Them

Starting with the backup T-Server, follow the upgrade steps described in “T-Server Migration Procedures” on [page 430](#) for each T-Server in the redundant pair. After this is done, follow these steps to complete the migration:

1. Stop all HA Proxies.
2. Stop all T-Servers.
3. For Avaya Communication Manager only: Configure links on the switch to connect to the hosts where the 8.0 T-Servers will run.
4. Reconfigure each T-Server to connect directly to their respective link:
 - a. Remove the HA Proxies from the `Connections` tab.
 - b. Create a CTI-Link section on the `Options` tab.
 - c. Configure the `link-n-name` option to point to the CTI-Link section.

Note: For T-Server for Avaya Communication Manager only. Each T-Server should be configured to connect to a different link.

5. Start the 8.0 T-Servers. (Refer to the “Start and Stop T-Server Components” chapter in your specific *T-Server 8.0 Deployment Guide* for startup instructions.)



Part

6

Migrating from the IP Media eXchange Solution to the SIP Server Solution

This section describes the IP Media eXchange migration.

- [Chapter 23, “IPMX 7.0.2 Migration to SIP Server 7.2,” on page 439](#) describes how to migrate IP Media eXchange (IPMX), and upgrade the components that belong to IPMX, after the successful migration of Framework.
- [Chapter 24, “Introduction to IP Media eXchange Migration,” on page 461](#), describes how to migrate 7.0.2 IP Media eXchange (IPMX) to the new 7.2 Genesys SIP Server architecture and how to upgrade the components that belong to the new SIP Server architecture, after the successful migration of Framework.



Chapter

23

IPMX 7.0.2 Migration to SIP Server 7.2

This chapter describes how to migrate Genesys IPMX to the new Genesys 7.2 SIP-based architecture and how to upgrade the components that belong to IPMX after Framework has been successfully migrated. Information in this chapter is divided into the following topics:

- [Overview, page 439](#)
- [General Instructions, page 440](#)
- [Migration from 7.0.2 to 7.2, page 444](#)
- [Changes From Previous Releases, page 454](#)

Overview

The migration of the 7.0.2 IPMX solution to the 7.2 SIP Server solution creates a new environment that functionally resembles the existing one, but has a different structure.

Most of the 7.0.2 (or previous) IPMX applications continue to be part of the 7.2 SIP Server solution. However, in 7.2, these applications play a much different role as the functional relationships and physical connections are different. You may want to reconsider the network topology of your implementation before you migrate your existing IPMX to the SIP Server-based implementation due to the change in roles and protocols of the IPMX solution components. See “Component Changes from 7.0.2 to 7.2” on [page 441](#) for more information.

The migration procedure involves two steps:

- Reconfiguration of the endpoints and devices.
- Deployment of the new Genesys software and the creation of its new configuration environment.

You should understand the scope and the need of reconfiguration of the existing endpoints and devices before migrating the Genesys IP server applications. The following should be taken into consideration:

- SIP endpoints and devices originally configured to use DMX as their SIP proxy/registrar should be reconfigured to use the SIP Server directly.
- H.323 endpoints and devices that can use SIP are recommended to be reconfigured to use SIP and to use SIP Server as its proxy/registrar.
- H.323 endpoints and devices that do not support SIP will use their original DMX as its gatekeeper/gateway, which in the new environment acts only as the gateway between H.323 and SIP networks.

Note: You may want to reconsider the network topology and the host allocation of the new Genesys server components used for your implementation.

The SIP Server 7.2 application does not necessarily have to be installed on the same host as where the original SMCP T-Server was installed.

You will want to decide on the number of DMX modules that you want to retain as H.323-to-SIP gateways, their host allocations, their ports, and their assignment of H.323 endpoints and devices.

Furthermore, it is likely that your 7.2 Genesys SIP Server solution will employ a significantly smaller number of Stream Manager applications since they no longer pass-through RTP/RTCP traffic and are only used for call treatment and conferencing services.

General Instructions

This section discusses the Required Framework Components, Licensing, and Component Changes from 7.0.2 to 7.2.

Required Framework Components

Genesys SIP Server solution requires these Genesys Framework components (see important note below about “[Licensing](#)” requirements):

- DB Server
- Configuration Server
- Configuration Manager
- Stat Server
- License Manager

If you are using Genesys Universal Routing Solution (Enterprise Routing and/or Network Routing), you will also need the Universal Routing Server (URS) and the Interaction Routing Designer.

If you have not already installed the DB Server and/or Stat Server for your solution, see the *Framework 7.2 Deployment Guide*.

Licensing

SIP Server uses the Genesys License Control System described in the *Licensing Genesys Products* document on the Documentation Library DVD. The licensing requirements specified in this document must be met before installing/configuring Genesys SIP Server.

A major change with Genesys Licensing is that URS licensing is no longer based on the number of instances of Universal Routing Server. Instead URS licensing is based on routing seats. URS licensing controls the number of active routing targets within concurrently active sessions. The number of currently activated routing targets cannot exceed the limit in the license file.

Note: URS High Availability (HA) mode now requires licensing.

Component Changes from 7.0.2 to 7.2

The Genesys SIP Server solution has been called IP Media eXchange (IPMX) or Voice over IP (VoIP) Option in previous releases. SMCP T-Server has been replaced by SIP Server. There are no changes to the names of the two IPMX components in this 7.2 release:

- Distributed Media Exchange (DMX)
- Stream Manager (SM)

However, each of these applications has a new role and contains new functionality in the 7.2 release. See the corresponding Deployment Guide for information about each component's functionality and option changes.

SIP Server

SIP Server 7.2 implements and extends the functionality formerly performed by the SMCP T-Server and DMX. It replaces both the SMCP T-Server as an application server and DMX as the switching component. Unlike SMCP T-Server, SIP Server directly interfaces with SIP endpoints and devices. But, it does not work directly with H.323 endpoints and devices.

DMX

DMX 7.2 no longer performs call switching and conferencing. It performs only as a H.323-to-SIP gateway in order to support endpoints and devices that cannot be reconfigured to use the SIP protocol. Therefore, DMX is no longer needed in a pure SIP environment.

DMX 7.2 performs the following functions:

- Negotiates codecs and converts protocols between SIP and endpoints using H.323 (H.225/245).
- Enables the exchange of audio and video media types across many networks, such as PSTN, PBX, LAN, and WAN.
- Performs in Traditional or Load Balancing modes.

Figure 17 illustrates the new role of DMX within the SIP Server solution architecture in release 7.2.

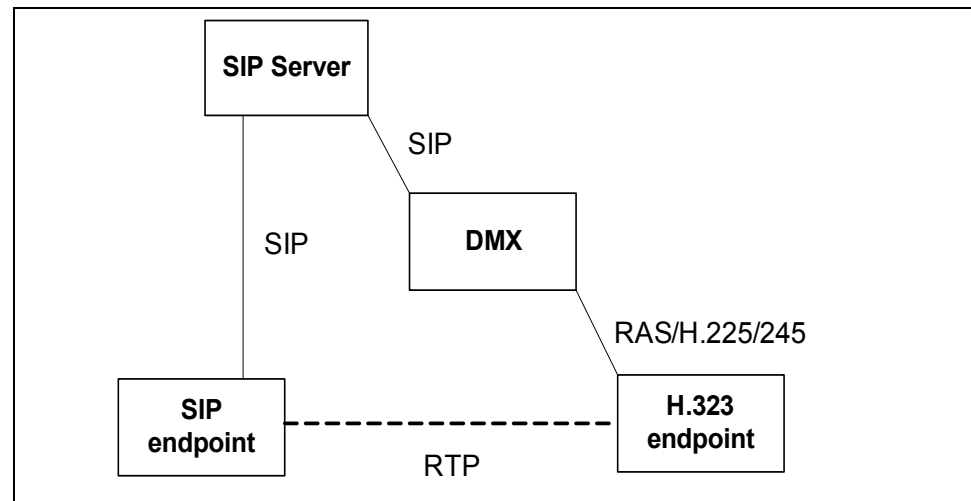

Figure 17: Changes in Architecture for 7.2 SIP/DMX Applications

Stream Manager

Previously, Stream Manager was a mandatory component controlled by DMX through a proprietary protocol. The major role of Stream Manager was passing the RTP/RTCP streams between the endpoints, with the exception of DMX when running in SM-bypass mode. As a secondary functionality, Stream Manager assisted DMX in performing call treatments and conferencing services.

Stream Manager 7.2 is used only as a media server. It generates and processes RTP streams to perform the following functions:

- Playing and recording announcements
- Recording announcement and conference call streams into files
- Basic conference call support
- Silent voice monitoring
- Whisper coaching
- DTMF support

Stream Manager 7.2 is controlled directly by the SIP Server through the SIP extension NETANN (Basic Network Media Services with SIP).

Figure 18 illustrates the applications that interact with Stream Manager to process call treatments.

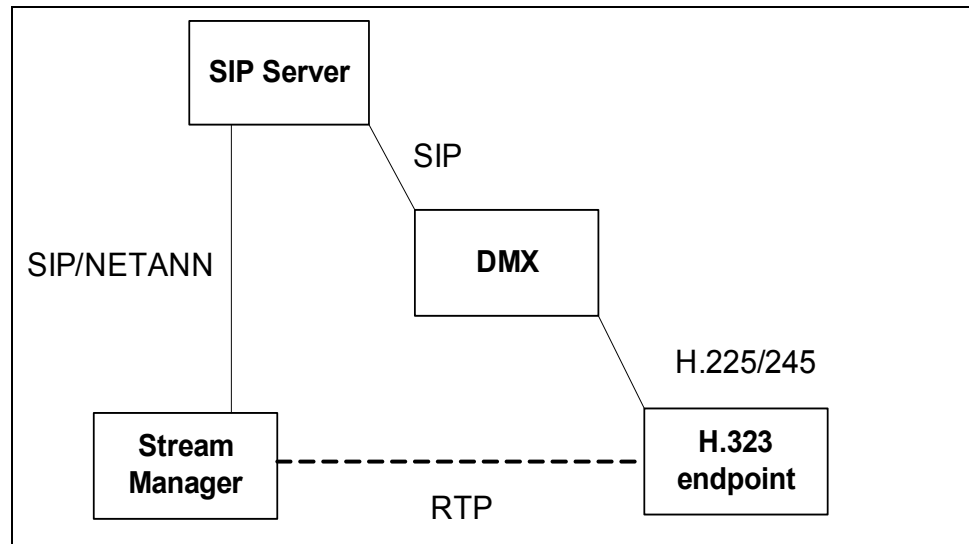

Figure 18: Stream Manager as a Call Treatment Server

Figure 19 illustrates Stream Manager's conference functions.

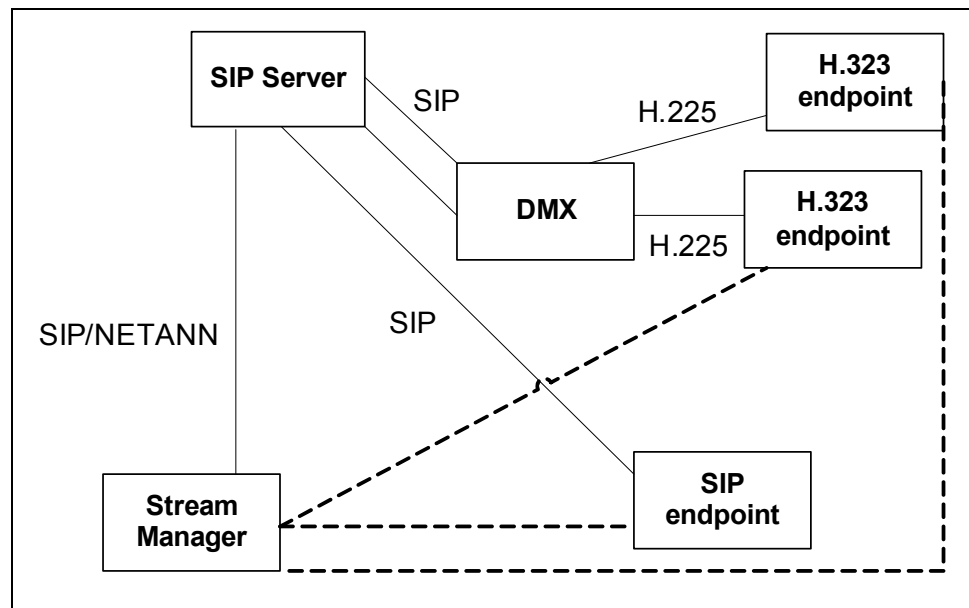

Figure 19: Stream Manager as a Conference Server

Migration from 7.0.2 to 7.2

The IPMX Upgrade procedure is intended for the creation of a configuration environment for the new SIP Server solution based on the existing IPMX configuration environment.

The migration of the Genesys IPMX software and configuration environment is guided by the IPMX Upgrade Wizard. The Wizard guides you through the steps to create a configuration environment for the new SIP Server solution, based on the existing IPMX configuration environment. The Wizard also modifies the configuration of several other Genesys solutions and components originally integrated with IPMX so that they integrate with the newly-deployed SIP Server solution in the same manner as they initially worked with the IPMX.

While configuring new and upgrading existing applications, the Wizard deploys and pre-configures installation packages for the new and upgraded applications. As you complete the configuration upgrade, use these installation packages to install new or upgrade existing software components.

Migration Procedure

Please complete the following recommendations before starting the Wizard:

- Familiarize yourself with the functionality and general deployment procedures of the 7.2 SIP Server, DMX, and Stream Manager applications. See the *Framework 7.2 SIP Server Deployment Guide* and *Framework 7.2 Stream Manager Deployment Guide* for more information about these components.
- Identify the following in your existing implementation:
 - Your current IPMX network topology.
 - Host allocations of the existing IPMX components.
 - The types, functionalities, and protocols that IPMX uses to interoperate with the endpoints and devices.
- Consider reconfiguring the H.323 endpoints end devices to use SIP Server.
- Plan your new SIP Server solution network topology and the host allocation of the new server components.
- Complete the migration to Framework 7.2.
- **Back up your configuration database prior to migration.** Use your database tools to do this.

Installing the Wizard

The following steps needs to be completed before you proceed:

- Install the Common Wizard Component Set from the Management Framework DVD.
- Install the SIP Server Configuration Wizard from the SIP Server DVD.
- If you are using Stream Manager, installed the Stream Manager Configuration Wizard from the Stream Manager DVD.

Starting the Wizard

Use the following steps to start the Wizard:

1. Launch Wizard Manager using the Genesys Wizard Manager shortcut in the Genesys Solutions\Framework folder of the Start menu.

Warning! You should not cancel, close, or terminate the Wizard until the Wizard completes the migration. Doing so will leave the configuration in an incomplete state that requires you to restore the original content of the configuration database from the backup you created.

2. Log into the Configuration Layer. Your account credentials must allow full control over the configuration objects under the Environment and Resources (in a single-tenant configuration environment) or the Tenant folders (in a multi-tenant configuration environment).
3. Check Display Individual Applications on the Wizard Manager's Upgrades page,
4. Select an existing SMCP T-Server application object in the list of applications.
5. Click the Upgrade button.

Note: If you have Configuration Manager installed, you can also launch the IPMX Upgrade Wizard from the Configuration Manager by right-clicking the SMCP T-Server application object and then selecting Wizard->Configure in the context menu, then pressing the Upgrade... button on the General page of the SMCP T-Server Properties dialog.

Warning! Avoid making any other changes in the configuration database while performing the upgrade using the Wizard.

Using the Wizard

You will perform the following major steps of the IPMX upgrade procedure under the Wizard's guidance.

- Create configuration objects for the new SIP Server configuration environment based on the existing IPMX configuration.
- Configure and deploy the SIP Server.
- Replicate the telephony configuration objects (such as DNs and Agent Logins) into the SIP Server environment.
- Manage DMX modules by upgrading and converting them for their new role as H.323-to-SIP gateways.
- Manage DN objects that represent H.323 endpoints and devices by assigning them to DMX gateways or converting them to SIP Server.
- Manage Stream Manager applications by upgrading and converting them for their new role as media servers.

The following sections provide a more detailed description for each of these steps.

Creating the SIP Server Solution Configuration Objects

The Wizard uses the SMCP T-Server that you selected for upgrade and its associated SMCP Switch as the base to create new configuration objects for the SIP Server solution. The new configuration objects are:

- `SIP Switch Switching Office` object: A virtual switching office that represents the entire SIP telephony solution and may contain configuration items common for all SIP Switches within your solution.
- `Switch` object: A virtual switch containing telephony configuration for a single SIP Server.
- `SIP Server Application` object: An application containing the configuration for the SIP Server application.

These three new objects will correspond to similar objects from your existing IPMX implementation. The Wizard closely matches the configuration of the new SIP Server objects so that the functionality of the new solution will be similar to the existing IPMX configuration.

Deploying and Configuring a New SIP Server Solution

The next step in the deployment of the new SIP Server solution is using the combined Switch and SIP Server Application Wizard. SIP Server is deployed by the same Configuration Wizard that is used for deploying a completely new SIP Server solution.

Note: This document is not intended for complete description of the SIP Server deployment. Please refer to the *Framework 7.2 SIP Server Deployment Guide* for detailed information about SIP Server functionality, configuration, and deployment processes.

While navigating through its windows, you will perform the following functions:

- Complete the configuration of the `Switch` object.
- Deploy the SIP Server installation package.
- Review the new features and configure major settings of the new SIP Server.
- Have the ability to review and customize SIP Server's advanced options.
- Commit the new objects into the configuration database.

Note: The difference between this deployment and the IPMX solution upgrade is that in order to match existing IPMX functionality, the initial settings and default values of the configuration options are initialized based on the existing IPMX solution. The SIP Server Wizard is aware of the IPMX upgrade process, so it may perform differently and produce a configuration different from the deployment of a new SIP Server.

The sections below focus on topics specific to an IPMX solution upgrade.

SIP Server Host By default, the SIP Server Wizard suggests to install the SIP Server on the host where the original SMCP T-Server is installed. Although this is recommended for most cases, it is not required. As the SIP Server combines the functionality of the SMCP T-Server and DMX, in certain cases it is recommended to deploy SIP Server on the host running one of the DMX modules, especially if the majority of the endpoints communicate with DMX using SIP Server. Installing SIP Server on this host will save you from reconfiguring the ability of these endpoints to contact the server on another host.

Listening Ports The port you specify in the `Server Information` Wizard page is the port that Genesys T-Server client applications will use to connect to SIP Server. By default, the Wizard suggests using the same T-Server client port as the original SMCP T-Server. It is recommended to leave it at this default value so that you will not need to reconfigure the client applications.

Note: If you are installing SIP Server on the host of the original SMCP T-Server and use the default port, the Wizard will warn you about the reuse of the same port by a different application. This is OK, as you are not going to run both SMCP and SIP Servers concurrently.

The SIP port you specify on the `Listening Ports` Wizard page defaults to the setting of the original DMX application port that was installed on the same host as the original SMCP T-Server. This saves you from reconfiguring SIP endpoints that were initially configured to work with this DMX application.

Note: As in the case of the T-Server client port, you will be warned of port reuse. The new SIP Server can not be run concurrently with the original DMX.

Installation Package

The Wizard asks you for the product DVD containing the SIP Server when deploying the SIP Server Installation Package. Ensure that the version is 7.2 or later of the SIP Server product DVD. The Wizard will not be able to configure earlier versions of SIP Server to replace the IPMX solution.

Note: The same copy of the Installation Package that is created by the Wizard should be used to install both primary and backup SIP Servers.

Backup Server Information

You may optionally deploy and configure a backup SIP Server, regardless if the original SMCP T-Server was deployed in the High Availability configuration or not. If you choose to deploy a backup SIP Server, the Wizard will create the backup SIP Server application object with the same configuration options as the primary server. You will be asked separately for the settings that differ between the primary and backup servers.

Warning! You should install the primary and backup SIP Servers on hosts running the same type and version of operating system due to the nature of the SIP Server High Availability implementation.

Common T-Server Options

Configuration options that are common for all T-Servers are copied from the corresponding options of the original SMCP T-Server. This process ensures that the existing functionality of your IPMX solution is retained. Common T-Server options new for the 7.2 release are initially set to their default values.

New SIP Server Functionality

The SIP Server Wizard will ask you to review the configuration options regarding major T-Server functionality and suggest that you configure any options that were not previously available in the existing IPMX solution.

Advanced Options

The Wizard will suggest that you review the complete list of configuration options it created for the SIP Server application object in the Advanced Properties Wizard window before committing this information into the configuration database. Although the Wizard is designed to create correct functional configuration in the majority of cases, you may still need to adjust some options specific for your implementation and environment. The Wizard does not enforce limitations on most of the options presented on the Advanced Property window; nor does it enforce their integrity.

Note: Although the Wizard presents you with a short description for most of the configuration options, you should consult the *Framework 7.2 SIP Server Deployment Guide* for a detailed description of each option, and also consult the SIP Server Release Notes and Release Advisory for any last-minute changes or additions that could not be part of the Wizard due to time limitations.

Replicating and Converting Telephony Objects

The next step performed by the IPMX Upgrade Wizard is to replicate and convert the following telephony objects into the new SIP Switch object from the original IPMX configuration. This task is completely automated.

Telephony objects such as DNs and Agent Logins define the telephony configuration of your IP solution. The Upgrade Wizard replicates and converts these objects from their original IPMX configuration into the new SIP Switch using the same configuration folder structure defined in the original Voice over IP SMCP Switch.

Agent Login codes and DN numbers are retained from the original configuration with one exception: SIP Server DNs do not contain the @ symbol in their numbers so it is replaced with an underscore. Aliases of the new DNs are also retained from the existing ones. This ensures that the existing references to the DNs by Number or Alias will continue to function.

Notes: In certain cases some original telephony objects may be modified in order to comply with integrity rules enforced by the Configuration Server. If this occurs, a corresponding warning record is added into the Wizard log.

Any original telephony object configuration settings that are not recognized by the Wizard are copied into new objects without change.

The DN object's `override` field that was used by IPMX for addressing and keeping DN-specific behavior modifiers is copied into the new SIP Server DNs. However, the value and its associated functionality is not recognized by SIP Server. The value of the `override` field is retained for reference only and for possible future use. Some elements of the original content of this field cannot be mapped into the configuration of the SIP Server DNs. The DN-specific behavior defined by these modifiers may not be exactly duplicated in the SIP Server environment.

References to the Telephony Objects

Several types of configuration objects that initially referred to their original telephony objects are updated to their corresponding new objects. The following objects and references are updated:

- Persons (Agents), Login IDs
- Places, assigned DNs
- DN Groups, assigned DNs
- Agent Groups, Place Groups, DN Groups, Origination DNs
- DNs, Default DNs
- Treatments, Destination DNs
- IVR Ports, Associated DNs
- Campaigns, Campaign Groups, Voice Transfer Destination

The new telephony objects are added to the list in one-to-many references. The references to old objects will be automatically deleted by Configuration Server

when you delete the Voice over IP SMCP Switch. In objects with one-to-one references, the references to the IPMX objects are replaced with the references to the new SIP Server objects.

Managing DMX Servers

DMX server no longer perform call switching and conferencing in the SIP Server architecture. It only performs as a H.323-to-SIP gateway in order to support endpoints and devices that cannot be reconfigured to use SIP.

Note: It is recommended that you reconfigure all endpoints and devices to use SIP and interoperate with the SIP Server directly in order to avoid protocol conversion overhead. You will no longer need DMX server if you already have or plan to switch to a pure SIP environment.

You will need to upgrade the DMX modules in `standalone`, `dual` and `client` modes to support the associated endpoints/devices if you plan to continue using endpoints and devices with the H.323 protocols. You will also need to upgrade related DMX servers in `gatekeeper` mode. DMX servers that you no longer plan to use should be marked as `Disabled`. The endpoints and devices originally associated with these DMX servers should be either reassigned to the remaining DMX servers or reconfigured to connect to SIP Server directly using SIP.

DMX no longer participates in call conferencing services. This functionality is now provided by Stream Manager servers that are directly controlled by the SIP Server. You should not upgrade any DMX servers that are in `MCU` mode.

The DMX Modules window in the IPMX Upgrade Wizard lists all the DMX servers associated with the original SMCP T-Server. The page requires you to either upgrade each DMX or disable it. Disabling it changes the corresponding DMX application object in Configuration Manager as `Disabled`.

Upgrading DMX

The DMX application is upgraded by the DMX Wizard. This is the same Configuration Wizard used for deploying DMX servers within the new SIP Server solution.

Note: This document is not intended for complete description of the DMX deployment. Please refer to *Part Three: DMX Reference Information* in the *Framework 7.2 SIP Server Deployment Guide* for more information about DMX functionality within the SIP Server solution, and its configuration and deployment processes.

The major changes for DMX servers within the SIP Server solution are as follows:

- DMX 7.2 no longer accepts connections from T-Server and no longer interoperates with T-Server through SMCP. The interoperation with the SIP Server is done through the SIP protocol.
- DMX 7.2 no longer uses Stream Manager servers.
- DMX 7.2 no longer interoperates with SIP endpoints and devices, except for SIP Server itself.

The DMX association with SIP Server is determined by the presence of a connection to SIP Server in the **Connections** tab of the DMX application object. This connection in the configuration object does not correspond to any permanent TCP connection between the two servers. It is used only to determine the proper destination for calls from a H.323 to a SIP environment.

DMX is treated as a regular gateway by the SIP Server. As with any other gateway, DMX should be represented in the SIP Server configuration as a **Trunk DN**, specifying the DMX host and SIP port in its **contact** option in the **Annex** tab.

Besides deployment of the new installation package, the DMX Upgrade Wizard makes changes in the configuration required for the new DMX servers to interoperate with the SIP Server. The Wizard will perform the following:

- Remove obsolete DMX options.
- Replace the connection to/from the SMCP T-Server with the one to the SIP Server.
- Create the **Trunk DN** representing DMX to the SIP Server as the gateway for the DMX in stand-alone, dual and client modes.
- Disable Stream Manager applications initially associated with the DMX.

Assigning H.323 DNs

This step is required only if the original IPMX configuration contained DNs which represent H.323 endpoints or devices.

The IPMX configuration does not have information about the assignment of these endpoints/devices to the DMX modules. However, this information is required in the SIP Server solution. Each H.323 DN representing an endpoint or device that you plan to keep should explicitly be assigned to one of the retained DMX servers. SIP Server will interface with each endpoint/device through the assigned DMX server. DNs that remain unassigned to any DMX server will be considered as SIP DNs. Any corresponding endpoint/devices should be reconfigured to use SIP and SIP Server as the proxy/registrar.

When you assign each DN into the configuration, the Wizard updates the **DN contact** option in the **Annex** tab with host and port information of the assigned DMX. The address of the endpoint/device itself is moved to the **Request-URI** entry.

Managing Stream Managers

Stream Manager servers were mandatory components controlled by DMX through a proprietary protocol in IPMX. With the exception of DMX running in the SM-bypass mode, the major role of Stream Managers was passing RTP/RTCP streams between endpoints. As a secondary functionality, Stream Manager assisted DMX in performing call treatments and conferencing services.

In a 7.2 SIP Server environment, RTP/RTCP traffic in two-way calls pass directly between the endpoints. Stream Manager is used only as a media server. It generates and processes RTP streams to perform the following functions:

- Playing and recording announcements.
- Recording announcement and conference call streams into files.
- Basic call conference support.
- Silent voice monitoring.
- Whisper coaching.
- DTMF support.

If you are not planning to use any of these functionalities, there is no need to upgrade Stream Manager. You may simply mark their application objects as `Disabled` within the Wizard, and later remove the application objects in Configuration Manager and then uninstall the Stream Manager applications from their host computers.

The Stream Manager window in the IPMX Upgrade Wizard lists all Stream Managers configured as part of the original IPMX solution. The window requires you to either upgrade each Stream Manager or disable it. Disabling simply marks corresponding application object in the configuration as `Disabled`. This acknowledges that this application will no longer be used.

Upgrading Stream Manager

The Stream Manger application is upgraded by the Stream Manager Wizard.

Note: This document is not intended as a complete description of the Stream Manager deployment. Please refer to the *Framework 7.2 Stream Manager Deployment Guide* for detailed information about Stream Manager functionality within the SIP Server solution, and its configuration and deployment process.

Although Stream Manager 7.2 retains its earlier mode of operation in which the client controls Stream Manager's operation through the permanent TCP connection using a proprietary protocol, this particular mode is limited in its functionality and is not recommended for the 7.2 SIP Server environment. Stream Manager should be configured as a stand-alone media server that accepts SIP requests from one or more clients using the SIP extension NETANN (Basic Network Media Services with SIP).

When upgrading Stream Manager in the SIP Server solution, the Stream Manager Wizard will ask you to specify the SIP port that the SIP/NETANN requests will be accepted from SIP Server. Make sure that no other application on the Stream Manager's host uses this port when specifying the SIP port.

Note: The majority of SIP applications, including SIP clients, use the default SIP port 5060.

Stream Manager is treated by SIP Server as an announcement server and a conference server. Each of these services should be represented in the SIP Server configuration by the `Voice over IP Service` DN with the `service-type` option containing a value of `music` and `mcu` accordingly.

The Stream Manager Wizard creates both these DNs and populates its `contact` option in the `Annex` tab with Stream Manager's host and port settings.

Completing the IPMX Upgrade Wizard

When the Wizard completes the upgrade, it presents a log listing any newly-created or updated configuration objects. The log may also contain warnings about circumstances that require additional attention.

The Upgrade Wizard does not remove any objects from the original configuration. Instead, it marks any unused objects as `Disabled`. After you have completed the migration and installation of all software components for the new solution and ensured that it is functional, you may want to cleanup the configuration by removing:

- Any obsolete objects, such as any application objects deleted by SMCP T-Server.
- Any DMX servers not upgraded and their associated Stream Managers.
- The original SMCP Switch together with its telephony objects may be also deleted. This will automatically remove any references to its telephony objects retained by the Upgrade Wizard in the rest of the configuration.

Rollback Instructions

The migration procedure not only creates a new configuration environment for the SIP Server solution, but it modifies the configuration of the existing IPMX solution by disabling its components. The Wizard also updates several configuration objects relevant to other Genesys solutions and components in order to integrate them with the new SIP Server solution.

The Wizard makes several mutually-dependent changes to many objects in the configuration database. The Wizard does not support the rollback of the changes it makes if it is cancelled during the migration process.

If for any reason the resulting configuration is not acceptable, the only way to rollback the changes made by the Wizard is to restore the configuration

database content from the database backup made before the Wizard was launched. Perform the following steps to restore the database:

1. Stop Configuration Server.
2. Restore the configuration database from the backup using your database management tools.
3. Restart Configuration Server.

Changes From Previous Releases

The following functionality will change from the previous release of IPMX after the Wizard has been run:

- SIP Server does not support a MCU device configured with the H.323 protocol. Previously in IPMX 7.0.2, a MCU device configured with the H.323 protocol was supported.
- DTMF tones produced from a SIP endpoint are not supported. Previously in IPMX 7.0.2, DTMF tones were supported when the option `media-proxy` was set with a value of 1.
- Remote 3pcc answer is not supported when other features associated with with the `call-mode` option are modified by the Wizard. Previously in IPMX 7.0.2, remote 3pcc answer was supported when the option `call-mode` was set with a value of R for a DN.

[Table 76](#), and [Table 77](#) list all changes in the configuration options for the DMX and Stream Manager components. All new options are optional and should be set to default values if they are not configured.

Table 78 on [page 456](#) displays a list of SIP Server option value differences between the SIP Server default value and the default value set by the Upgrade Wizard.

The following table lists the DMX option changes:

Table 76: DMX Option Changes

Current Option Name	Type of Change	Change Occurred Version
<code>amd-mode</code>	new option	7.2
<code>delay-own-tcs</code>	new option	7.0
<code>dtmf-sip</code>	new option	7.0
<code>leg-record-timeout</code>	obsolete option	7.2
<code>leg-regular-timeout</code>	obsolete option	7.2

Table 76: DMX Option Changes (Continued)

Current Option Name	Type of Change	Change Occurred Version
-mcu	obsolete option	7.2
MediaWaitForConnect	obsolete option	7.2
progress-inband	new option	7.0
silence-suppression	new option added to x-config section	7.0
sip-port	new option	7.0
sip-transport	new option	7.0
t120	obsolete option	7.2
video-codec	new option added to x-config section	7.0

[Table 77](#) lists the Stream Manager option changes:

Table 77: SM Option Changes

Current Option Name	Type of Change	Change Occurred Version
sip-port sip-default-annc sip-annc-codecs sip-conf-codecs sip-http-codecs	new options	7.2
rtp-stream-delay file-cache-size audio-file-format	new options	7.2
log-trace-flags	new option	7.2
sip-h261-fmtp sip-h263-fmtp	new options	7.2
call-address	new \$AUTO value	7.2

Table 77: SM Option Changes (Continued)

Current Option Name	Type of Change	Change Occurred Version
debug-level -pc mixer-buffer-range	obsolete options	7.2
max-record-file-size	new option	7.0
max-record-silence	new option	7.0
max-record-time	new option	7.0
-pc	obsolete command line option	7.2
rtp-inactivity-timeout	new option	7.0
rtp-ip-precedence	new option	7.0

Table 78 lists SIP Server options (and default values, where specified) and the value change after the Upgrade Wizard:

Table 78: Upgrade Wizard SIP Server Option Changes

SIP Server Option	Upgrade Wizard Default Value
sip-port	Uses DMX: x-config\sip-port
sm-port	Uses DMX: x-config\sm-port
audio-codecs	Uses DMX: x-config\audio-codec. 1: PCMU 2: PCMA 3: G723 4: G729 8: GSM
ring-tone = music/ring_back	Uses value from SMCP TServer\ring-tone
busy-tone = music/busy_5sec	Uses value from SMCP TServer\no-answer-5sec-tone

Table 78: Upgrade Wizard SIP Server Option Changes (Continued)

SIP Server Option	Upgrade Wizard Default Value
fast-busy-tone = music/atb_5sec	Uses value from SMCP TServer\fast-busy-tone
silence-tone = music/silence	Uses value from SMCP TServer\silence-tone
collect-tone = music/collect	Uses value from SMCP TServer\collect-tone
default-music = music/on_hold	Uses value from SMCP TServer\hold-music
sip-enable-moh = false	If SMCP TServer\hold-music is specified, then the value is true. Otherwise, the value is false.
wrap-up-time = 0	Uses value from SMCP T-ServerServer\after-call-work
inbound-bsns-calls = false	true (SMCP T-Server treats all calls as business)
outbound-bsns-calls = false	true (SMCP T-Server treats all calls as business)
internal-bsns-calls = false	true (SMCP T-Server treats all calls as business)
unknown-bsns-calls = false	true (SMCP T-Server treats all calls as business)
agent-strict-id = false	Uses value from SMCP TServer\login-verify
inherit-bsns-type = false	false (SIP Server default)
legal-guard-time = 0	If the value of the option TServer\notready-after-acw is false, then the new value is 0. Otherwise, the new value is 30.
notrdy-bsns-cl-force-rdy = false	false (SIP Server default)
timed-cwk-in-idle = true	false (There is no manual wrapup timer in SMCP T-Server.)
cwk-in-idle-force-ready = true	false (There is no manual wrapup timer in SMCP T-Server.)

Table 78: Upgrade Wizard SIP Server Option Changes (Continued)

SIP Server Option	Upgrade Wizard Default Value
agent-no-answer-timeout = 15	Uses value from SMCP TServer\acdq-rna-timeout
extn-no-answer-timeout = 15	Uses value from SMCP TServer\acdq-rna-timeout
posn-no-answer-timeout = 15	Uses value from SMCP TServer\acdq-rna-timeout
recall-no-answer-timeout = 15	Uses value from SMCP TServer\acdq-rna-timeout
agent-no-answer-action = none	none (SIP Server default)
agent-no-answer-overflow =	recall (The only action in SMCP T-Server.)
extn-no-answer-overflow =	recall (The only action in SMCP T-Server.)
posn-no-answer-overflow =	recall (The only action in SMCP T-Server.)
nas-private = false	true (There are no private calls in SMCP T-Server.)
predictive-call-router-timeout = 20	20 (SIP Server default)
prd-dist-call-ans-time = 0	0 (SIP Server default)
max-pred-req-delay = 3	3 (SIP Server default)
default-dn =	Uses value from SMCP T-Server\inbound-default-dn
am-detected = drop	connect (The default SMCP T-Server behavior.)
fax-detected = drop	connect (The default SMCP T-Server behavior.)
external-registrar =	(empty) (SIP Server default)
internal-registrar-enabled = true	true (SIP Server default)
internal-registrar-domains =	(empty) (SIP Server default)

Table 78: Upgrade Wizard SIP Server Option Changes (Continued)

SIP Server Option	Upgrade Wizard Default Value
rq-expire-tmout = 32000	32000 (SIP Server default)
call-rq-gap = 0	0 (SIP Server default)
sip-hold-rfc3264 = false	false (SIP Server default)
dtmf-payload = 101	Uses value from SMCP TServer\dtmf-payload-type
router-timeout = 10	10 (SIP Server default)
sip-block-headers =	SIP Server default
make-call-alert-info =	true (SIP Server default)
sip-enable-100rel = true	true (SIP Server default)
ringing-on-route-point = true	true
session-refresh-interval = 1800	1800 (SIP Server default)
max-legs-per-sm = 0	0 (no limit in SMCP T-Server)
owerride-to-on-divert = false	SIP Server default
unknown-xfer-merge-udata = false	SIP Server default



Chapter

24 Introduction to IP Media eXchange Migration

This chapter describes how to migrate IP Media eXchange (IPMX) and upgrade the components that belong to IPMX after Framework has been successfully migrated. Information in this chapter is divided into the following topics:

- [General Instructions, page 461](#)
- [Migration from 6.5 to 7.0, page 464](#)

The first release of IPMX was 6.0, under the name Voice over IP (VoIP) Option.

General Instructions

The following section discusses:

- [“Required Framework Components” on page 461](#)
- [“Licensing” on page 462](#)
- [“Component Changes from 6.5 through 7.0” on page 462](#)
- [“Other Migration Issues” on page 464](#)

Required Framework Components

IPMX requires these Genesys Framework components (see important note below about [“Licensing”](#) requirements):

- DB Server
- Configuration Server
- Configuration Manager
- Stat Server
- License Manager

If you are using Genesys Universal Routing Solution (Enterprise Routing and/or Network Routing), you will also need the Universal Routing Server and the Interaction Routing Designer.

If you have not already installed the DB Server and/or Stat Server for your solution, see the *Framework 7.0 Deployment Guide*.

Licensing

IP Media eXchange 7.0 uses the Genesys License Control System described in the *Licensing Genesys Products* document on the Documentation Library DVD. The licensing requirements specified in this document must be met before installing/configuring IP Media eXchange components.

A major change with Genesys 7 licensing is that URS licensing is no longer based on the number of instances of Universal Routing Server. Instead URS licensing is based on routing seats. URS licensing controls the number of active routing targets within concurrently active sessions. The number of currently activated routing targets cannot exceed the limit in the license file.

Also, URS High Availability (HA) mode now requires licensing.

Component Changes from 6.5 through 7.0

IPMX was called Voice over IP (VoIP) Option in releases 6.1 and 6.5. There have been no changes to the names of its three components:

- Simple Media Control Protocol (SMCP) T-Server
- Distributed Media Exchange (DMX)
- VoIP Stream Manager (SM)

Between 6.1 and 6.5 several changes were made to the object types for the DMX and SM components. See [Table 79](#).

Table 79: IPMX Application Objects and Types

Application	Object Type		
	5.1	6.0	6.1 and Later
VoIP Stream Manager (SM)	Third-Party Server	Third-Party Server	Voice over IP Stream Manager
Distributed Media Exchange (DMX)	Third-Party Server	Voice over IP Controller	Voice over IP DMX Server
SMCP T-Server	TServer		

The type of DMX and SM object to use depends on the underlying version of Genesys Framework. Refer to *IPMX 7.0 Reference Manual*, Chapter 3 “IPMX Configuration Objects” for additional information.

DMX

Changes in the functionality for DMX include:

- Support for the Session Initiation Protocol (SIP) RFC 3261 and is compatible with the most popular SIP-compatible, off-the-shelf hardware or software for DMX.
- Video exchange for H.323 (NetMeeting 3.01) and SIP-protocol (Messenger 5.0 under Windows XP).
- Full compatibility with Genesys Framework 6.5 and can now be used in conjunction with ConfigServer 6.5 and DB Server 6.5.
- Ability to be configured to become a software-based Voice Conferencing and Multipoint Control Unit (MCU).
- It is now possible to run DMX in single or multi-mode configurations with DMX in the following roles:
 - One DMX is both gatekeeper and client simultaneously.
 - Multi-DMX configurations where each DMX is both gatekeeper and client simultaneously.
 - One DMX is gatekeeper and the other DMXs (up to three) are clients.
 - One DMX is both gatekeeper and client at the same time and the other is in MCU mode.

SM

Changes in the functionality of SM include:

- Transfers of Application Sharing (T.120 Protocol) Sessions with data preservation for SM.
- Call recording.
- Call Progress Treatment support.
- Silent Voice Monitoring.
- Voice/Video Mute Control.
- Full compatibility with Genesys Framework 6.5 - SM can now be used in conjunction with ConfigServer 6.5 and DB Server 6.5.

Other Migration Issues

There are no major changes in the architecture between IPMX 6.1/ 6.5 and 7.0. Some new features added in release 7.0 may require changes to your configuration. See *IPMX 7.0 Getting Started Guide* for a list of new features and *IPMX 7.0 Reference Manual* for details on configuration.

Migration from 6.5 to 7.0

The following information summarizes the migration from release 6.1 or 6.5 to 7.0.

General Recommendations

- First complete the migration of Framework (see the chapters on Framework migration in this guide).
- Do not make any changes to your IPMX configuration, except as described in Step 2 of “[Migration Procedure](#)” on [page 465](#). Install the new IPMX 7.0 components to your existing IPMX configuration objects.
- You should back up your IPMX configuration data prior to migration. To do this, follow these steps for each IPMX component:
 - a. In Configuration Manager, open the Properties dialog box for the component application object.
 - b. From the Options tab, export the default configuration options to a configuration file. Keep this file in case you have problems configuring IPMX 7.0 and need to return to the previous version.
- For the same reason, you should install the new IPMX components into a different directory than the existing environment.

To facilitate the configuration of new 7.0 features, it may be helpful to view options within new object templates. This requires importing templates to Configuration Manager.

Warning! Do not import the templates into existing applications. You could overwrite existing configuration options.

Migration Procedure

The following steps should be performed to ensure a successful migration:

1. Install each Genesys IPMX component (DMX, SM and SMCP T-Server), using the Installation Package.

- Use separate installation packages rather than the wizard to maintain a tight control on what objects are changed within Configuration Manager. Wizards will prompt you to install an entire new switching environment.

The installation package installs the following new files:

- Executables (DMX, SM, SMCP T-Server)
- Batch Files (DMX, SM, SMCP T-Server)
- Log Message System Files (DMX, SM, SMCP T-Server)

No changes are made to the Configuration database during this time.

2. Make the following modifications within Configuration Manager:
 - Switch—add a DN of type Voice Over IP Service for calls over IP networks, such as the public Internet (new requirement for 7.0). For details see *IPMX 7.0 Reference Manual*, Chapter 3 “IPMX Configuration Objects,” the section on “Addressing for Services.”
 - DMX Application—If you want to use the optional RAS Client/Server functionality, you must add the section Gatekeeper and its options to the Options tab. The Gatekeeper options are listed in *IPMX 7.0 Reference Manual*, Chapter 5 “Configuration Options,” section on “DMX options.”
 - T-Server Application—T-Server is a licensed component and requires access to a license file. The batch file must make reference to a license file using the -l parameter or the license file option must be configured.
 - SM Application—Add an option called debug-level to the x-config section. (see *IPMX 7.0 Reference Manual*, Chapter 5 “Configuration Options,” for full descriptions of all options).

Rollback Instructions

For each IPMX component, do the following:

1. In the Configuration Manager, display the Properties dialog box for the application.
2. On the Options tab, click the Import from Configurations File icon and locate the configuration file you exported in Step 2 under “General Recommendations” on [page 464](#). This procedure overwrites the options on this tab with those in the configuration file.
3. Make any other required changes, such as configuring connections to the applications of the restored environment.
4. Click OK to save the changes and close the dialog box.

Changes in Configuration Options

Table 80, Table 81, and Table 82 list all changes in the configuration options for the three IPMX components. All new options are optional and should be set to default values if they are not configured.

Table 80: SMCP T-Server Option Changes

Current Option Name	Type of change	Change occurred in Version #	Details (optional)
acdq-rna-timeout	new option added to TServer section	7.0	60
all	default value changed in log section	7.0	Old value: stdout New value: stderr
addp-remote-timeout	new option added to backup-sync section	7.0	0
addp-timeout	new option added to backup-sync section	7.0	0
addp-trace	new option added to backup-sync section	7.0	off
add-trp-info	new option added to TServer section	7.0	false
background-timeout	new option added to TServer section	7.0	60 ms
bad-destination-5sec-tone	new option added to TServer section	7.0	music/sit_5sec
bad-destination-tone	new option added to TServer section	7.0	music/sit
buffering	removed from log section	7.0	true
busy-5sec-tone	removed from TServer section	7.0	music/busy_5sec

Table 80: SMCP T-Server Option Changes (Continued)

Current Option Name	Type of change	Change occurred in Version #	Details (optional)
busy-tone	removed from TServer section	7.0	music/busy_tone
cast-type	default option changed in extrouter section	7.0	Old value: route New value: route direct reroute pullback direct-uu direct-notoken direct-ani dnis-pool direct-digits
cof-ci-req-tout	default option changed in extrouter section	7.0	Old value: 500 New value: 500 msec
cof-rci-tout	default option changed in extrouter section	7.0	Old value: 10 New value: 10 sec
collect-tone	new option added to TServer section	7.0	music/collect
configuration-error-5sec-tone	new option added to TServer section	7.0	music/reorder_5sec
configuration-error-tone	new option added to TServer section	7.0	music/reorder
debug	removed from TServer section	7.0	stdout
destination-busy-5sec-tone	new option added to TServer section	7.0	music/busy_5sec
destination-busy-tone	new option added to TServer section	7.0	music/busy
dn-request-limit	new option added to TServer section	7.0	100

Table 80: SMCP T-Server Option Changes (Continued)

Current Option Name	Type of change	Change occurred in Version #	Details (optional)
do-not-call-free-dn	new option added to TServer section	7.0	false
event-propagation	removed from extrouter section	7.0	list
expire	removed from log section	7.0	false
fast-busy-tone	new option added to TServer section	7.0	music/atb_5sec
inbound-to-pbx	removed from TServer section	7.0	false
license	new section	7.0	
license-file	removed from TServer section	7.0	<required> moved to license section
log-trace-flags	new option added to TServer section	7.0	+isc +cfgSdn -cfgserv +passwd +udata - devlink -sw - req -callops -conn -client
make-after-answer	new option added to TServer section	7.0	false
max-call-returns	new option added to TServer section	7.0	1
max-call-setup-repeats	new option added to TServer section	7.0	3
network-callback	new option added to TServer section	7.0	
network-default-dn	new option added to TServer section	7.0	
network-failure-5sec-tone	new option added to TServer section	7.0	music/atb_5sec

Table 80: SMCP T-Server Option Changes (Continued)

Current Option Name	Type of change	Change occurred in Version #	Details (optional)
network-failure-tone	new option added to TServer section	7.0	music/atb
network-max-calls	new option added to TServer section	7.0	0
network-service-dn	new option added to TServer section	7.0	
no-answer-5sec-tone	new option added to TServer section	7.0	music/rna_5sec
no-answer-tone	new option added to TServer section	7.0	music/rna
no-music-to-mcu	new option added to TServer section	7.0	false
normal-release-5sec-tone	new option added to TServer section	7.0	music/normal_5sec
normal-release-tone	new option added to TServer section	7.0	music/normal
notready-after-acw	new option added to TServer section	7.0	false
num-of-licenses	removed from TServer section	7.0	max moved to license section
num-sdn-licenses	new option added to TServer section	7.0	max added to license section
old-smcp	removed from TServer section	7.0	true
pretend-status	removed from TServer section	7.0	true

Table 80: SMCP T-Server Option Changes (Continued)

Current Option Name	Type of change	Change occurred in Version #	Details (optional)
queue-music	default value changed in TServer section	7.0	Old value: music/in_queue New value: None
reconnect-tout	default value changed in extrouter section	7.0	Old value: 5 New value: 5 sec
reject-subsequent-request	default value changed in agent-reservation section	7.0	Old value: 0 New value: true
release-tone	new option added to TServer section	7.0	music/release
request-collection-time	default value changed in agent-reservation section	7.0	Old value: 100 New value: 100 msec
request-tout	default value changed in extrouter section	7.0	Old value: 20 New value: 20 sec
reservation time	default value changed in agent-reservation section	7.0	Old value: 10000 New value: 10000 msec
resource-allocation-mode	new option added to extrouter section	7.0	circular
resource-load-maximum	new option added to extrouter section	7.0	0
queue-max-calls	new option added to TServer section	7.0	0
rtp-info-password	new option added to TServer section	7.0	

Table 80: SMCP T-Server Option Changes (Continued)

Current Option Name	Type of change	Change occurred in Version #	Details (optional)
segment	removed from log section	7.0	false
silence-tone	new option added to TServer section	7.0	music/silence
sip-callid-host	new option added to TServer section	7.0	
tcs-queue	new option added to extrouter section	7.0	
tcs-use	new option added to extrouter section	7.0	never
timeout	default value changed in extrouter section	7.0	Old value: 60 New value: 60 sec
user-data-limit	new option added to TServer section	7.0	16000
verbose	default value changed in log section	7.0	Old value: trace New value: standard
voice-call-monitoring-password	new option added to TServer section	7.0	
voice-call-monitoring-target-hint	new option added to TServer section	7.0	no

DMX 6.5 and higher has a new Options section called **gatekeeper**. The default value for this option might be different depending on the DMX mode template (see [Table 81](#) and [Table 82](#)).

Table 81: DMX Option Changes

Current Option Name	Type of change	Change occurred in Version #	Comment
collect-digits	new option	7.0	default value: false Value: x-conf ig Note: Every time DMX 6.5 performs digits collection, it sends new digits along with the old ones.
delay-own-tcs	new option	7.0	2000 (msecs)
dtmf-sip	new option	7.0	rtp-nte
leg-record-timeout	new option added to x-config section	7.0	10000
leg-regular-timeout	new option added to x-config section	7.0	30000
-mcu	new command line option	7.0	
MediaWaitForConnect	new option	7.0	false
progress-inband	new option	7.0	false
silence-suppression	new option added to x-config section	7.0	null
sip-port	new option	7.0	5060
sip-transport	new option	7.0	udp

Table 81: DMX Option Changes (Continued)

Current Option Name	Type of change	Change occurred in Version #	Comment
t120	new option added to x-config section1	7.0	false
video-codec	new option added to x-config section	7.0	0

Table 82: SM Option Changes

Current Option Name	Type of change	Change occurred in Version #	Comment
max-record-file-size	new option	7.0	0
max-record-silence	new option	7.0	0
max-record-time	new option	7.0	300
-pc	new command line option	7.0	normal
rtcp-inactivity-timeout	new option	7.0	30 secs
rtp-ip-precedence	new option	7.0	0



Part

7

SIP Server Solution Migration

This section describes the migration of SIP Server, Network SIP Server, and Stream Manager from releases 7.2, 7.5, and 7.6 to release 8.0. It discusses component changes, and the Genesys software that supports and enables SIP Server solution functionality.

The information is divided into the following chapters:

- [Chapter 25, “Introduction to SIP Server Solution Migration,”](#) on page 477 provides background information on SIP Server solution migration.
- [Chapter 27, “Changes in Configuration Options,”](#) on page 491 offers a list of configuration options that may have changed since you last deployed the SIP Server solution.
- [Chapter 26, “SIP Server Solution Migration Procedures,”](#) on page 485 provides the required steps to migrate the SIP Server solution.

Refer to “Migrating from the IP Media eXchange Solution to the SIP Server Solution” on [page 437](#) for information about the migration procedures of Genesys products to release 7.2



Chapter

25

Introduction to SIP Server Solution Migration

This chapter provides background information on how to migrate and upgrade the SIP Server, Network SIP Server, and Stream Manager products.

Basic information about the SIP Server solution and SIP Server options is available in:

- *Framework 8.0 SIP Server Deployment Guide*
- *Stream Manager 7.6 Deployment Guide*
- *Framework 7.5 Network SIP Server Deployment Guide*

This chapter discusses the following topics:

- [Preliminary Migration Procedures, page 477](#)
- [Migration Considerations, page 478](#)
- [Interoperability Among Framework Components, page 482](#)

Note: References to SIP Server in these chapters also apply to Network SIP Server, except where noted.

Preliminary Migration Procedures

Note: If you want to upgrade your operating system, you must do this before migrating your Genesys product.

The migration process includes these preliminary procedures for the SIP Server solution:

1. Review Chapter 1, “Migration Roadmap,” on [page 35](#) of this guide.

2. Examine the order in which the Genesys software required for Framework 7.6 should be upgraded.
3. Examine the component changes for the SIP Server solution in Chapter 27, “Changes in Configuration Options,” on [page 491](#).
4. Look at the option changes in Chapter 27, “Changes in Configuration Options,” on [page 491](#).

Note: These tables only discuss changes that directly affect the migration of this product. For a complete list of configuration options for the SIP Server solution, see the *Framework 8.0 SIP Server Deployment Guide*; the *Stream Manager 7.6 Deployment Guide*; and the *Framework 7.5 Network SIP Server Deployment Guide*. For a list of documentation relevant to the migration of this product, see the list below.

5. Review the licensing requirements for Framework 7.6. See Chapter 2, “Licensing Migration,” on [page 41](#) in this guide.
6. Check the interoperability of the components of Framework 7.6 during the upgrade procedures.

See the following documents for more information about compatibility among different versions of Genesys products.

- *Framework 8.0 SIP Server Deployment Guide*
- *Stream Manager 7.6 Deployment Guide*
- *Framework 7.5 Network SIP Server Deployment Guide*
- *Genesys Licensing Guide*
- *Framework 7.6 Deployment Guide*
- *Genesys 8 Interoperability Guide*

Migration Considerations

Migration paths depend on the version of the specific SIP Server that you are migrating. In all cases it is assumed that you are migrating to the most recent version of your application.

Multi-Site/Single-Site and Multi-Tenant Migration

SIP Server migration requires the planning of system operation during the migration process:

- In single-site migrations, you need to suspend work in your production environment during the SIP Server solution migration process.

- In multi-site environments, while you are undergoing the migration process, you need to reroute work through another SIP Server (or Stream Manager) during the upgrade, in order to avoid suspending work.

Redundant SIP Servers

Since SIP Server can operate in a high-availability (HA) configuration providing you with redundant systems, you may be migrating multiple servers. In the cases of both primary and backup SIP Servers, the migration process is the same.

Required Framework Components

SIP Server is a part of the Framework Media Layer. Refer to Framework 7.6 documentation to learn about the role of SIP Server in the Media Layer, and about the Media Layer's role within the overall scope of a Framework migration. Be sure to refer to earlier portions of this guide which provide an overall picture of the larger migration process for all your Genesys components, and identify the specific point at which SIP Server is migrated.

Note: Be sure to upgrade or install components of the Framework Configuration Layer before you migrate your SIP Server. See the Framework Migration section in this guide.

Licensing Changes

Regardless of which version of SIP Server you have prior to migrating, be sure to check on the licensing requirements for the new version. In all cases, refer to the *Genesys Licensing Guide* available on the Technical Support Website for more information.

Note: In the Genesys 7 Framework, high-availability configurations do not require duplicate licenses. The HA license for your SIP Server applies to both the primary and backup SIP Servers.

Earlier Configuration Environment

SIP Server 8.0 is fully backward compatible with the pre- 8.0 release of SIP Server clients. See “Interoperability Among Framework Components” on [page 482](#) for details on mixed environments. The 8.0 SIP Server features can be configured using 7.6 Configuration Layer.

SIP Server Solution Enhancements

The following sections describe some of the major functional differences between the 7.6 and 8.0 releases of the SIP Server solution.

SIP Server

The enhancements include:

- **TCompleteTransfer using REFER or REFER with Replaces header.** SIP Server now supports the TCompleteTransfer operation by using either the SIP REFER method or the SIP REFER method with the Replaces header.
- **Automatic Agent Logout.** SIP Server can now automatically log out an agent after a specified period of inactivity, ensuring accurate reporting of agent activity.
- **Enhanced geo-location support.** SIP Server now supports the ability to assign the geo-location for a call from the routing strategy, which takes precedence over geo-location configured at the DN-level in Configuration Manager.
- **Support for TClearCall requests.** TClearCall instructs SIP Server to delete all parties from any type of call. This includes call operations currently underway or currently queued (for example, a HoldCall operation delayed while waiting for a response to an INVITE request).
- **Enhanced high availability (HA) support.** SIP Server now supports several additional capabilities related to high availability deployments:
 - SIP Server now supports high availability configurations where both primary and backup SIP Server instances reside on a single host server.
 - SIP Server now synchronizes the SIP registration contact header for a particular device across both primary and backup SIP Server instances.
- **Enhanced reliability for media services.** SIP Server now immediately re-invites the next available media server, in cases where a BYE message is received from the media server while playing music-on-hold or ringback tone, or when the HTTP stream is disconnected.
- **Nailed-Up Agent.** SIP Server can now provide a persistent SIP session for agents that require a dedicated connection to the contact center—typically for TDM agents dialing in to the contact center from the PSTN.
- **Enhanced Agent No-Answer Supervision.** SIP Server can now apply Agent No-Answer Supervision functionality (alternate routing or forced agent logout) in cases where an agent DN returns a 4xx rejection response to an INVITE request.
- **Support for Quality of Service (QoS).** SIP Server can now set QoS bits to a user-defined value in order to prioritize SIP signaling traffic.
- **Stuck Calls Cleanup.** SIP Server now supports the detection and cleanup of stuck calls.

- **Support for early media.** SIP Server now supports the exchange of early media before a particular session is accepted (for example, to provide an audio treatment before the call is answered, thereby avoiding toll charges for the caller).
- **Support for ITU-T Recommendation E.164.** SIP Server now supports the E.164 recommendation for the international public telecommunication numbering plan.

Note: See the *Framework 8.0 SIP Server Deployment Guide* for more information about these changes.

Stream Manager

The enhancements for Stream Manager include:

- Support for Quality of Service (QoS). Stream Manager can now set QoS bits to a user-defined value in order to prioritize SIP signaling traffic.
- The off-line transcoding utility in Stream Manager, `smzip`, can now convert audio files from one codec to another.
- Stream Manager can now reject new dialogs based on a configured load threshold.
- Stream Manager can now send two types of DTMF tones—digitized tones and named telephone events (RFC 2833).

Network SIP Server

The enhancements for Network SIP Server include:

- Network SIP Server supports the `default-route-destinations` configuration option at both the Application and the Switch/DN level.
- Network SIP Server supports the `OPTIONS` SIP request. Network SIP Server returns a `200 OK` SIP message as a response to that request.

Note: See the *Framework 7.5 Network SIP Server Deployment Guide* for more information about this change.

Stream Manager Considerations

When migrating to the recent version of Stream Manager, pay attention to the following items:

- If you are migrating from release 7.2, you must update your video file names.

- In pre-7.5 releases, the `sip-h261-fmt` and `sip-h263-fmt` options controlled both the SDP (Session Description Protocol) and the file selection. In 7.5 release and later, the SDP and the file selection are individually specified in the `sip-h26x-fmt` and `h26x-ann-c-fmts` options.
- In pre-7.5 releases, the order of the codecs listed in the `sip-ann-c-codecs` and `sip-conf-codecs` options determined how call or conference recording was performed. In 7.5 release and later, the `sip-record-codec` option determines this functionality.
- In pre-7.6 releases, the list of codecs for Real-time Transcoding feature was controlled by the `sip-conf-codecs` option. In 7.6 release, this option affects conferences only. A new option, `sip-trans-codecs`, has been added to control transcoding.

There are many changes to configuration options between release 7.5 and 7.6. For more information, see “Stream Manager” on [page 497](#) in this Migration Guide and the *Stream Manager 7.6 Deployment Guide*.

Interoperability Among Framework Components

The term *interoperable* refers to environments where different versions of Genesys solutions, components, or options work together compatibly during the migration process.

Interoperability of Genesys products can occur at two levels of migration:

- **Interoperability at the suite-level** means combining different versions of solutions and options during the migration process.

Example: You can migrate to the Configuration Layer of Framework 7.6 while still using 6.5 components. See *Genesys 7 Interoperability Guide* and the *Genesys 8 Interoperability Guide* for information on the compatibility of Genesys products with various Configuration Layer Environments; Interoperability of Reporting Templates and Solutions; and *Gplus* Adapters Interoperability.

- **Interoperability at the solution-specific level** means combining different versions of the components of a particular solution while upgrading them sequentially during the migration process.

Example: The mixture of components may include executables, applications, routing strategies, scripts, and data that comprise a particular solution.

As you upgrade each of the components in sequence, you will need to know if it is backward-compatible with the other components of your environment.

SIP Server Interoperability

If you are running your SIP Servers in either hot or warm standby mode in a single-site deployment, then the primary and backup SIP Servers must both be of the same release family (although within the family there can be minor-release differences).

Multi-site deployments of SIP Server allow for interoperability of SIP Server versions between sites. You can migrate one SIP Server without migrating your other SIP Servers. Use this concept to keep your production system up during migration. You will need to route work through alternate SIP Servers while migrating a given SIP Server to the current release.

An additional consideration for multi-site deployments—special configuration is required in cases where resources on different SIP Server switches share the same name. Prior to release 7.5, SIP Server differentiated between internal and inbound calls based on information in specific SIP headers. Starting in release 7.6, however, SIP Server relies strictly on the option `enforce-external-domains` to differentiate inbound from internal calls, in cases where the user name in the `From` header of the incoming `INVITE` matches the name of any internal resource. This option must be configured on every SIP Server instance in a multi-site deployment, and must contain the addresses of all the other SIP Server instances in the deployment. In addition, for Trunk DN's that point to an external SIP Server, if you configure `override-domain-from` on the trunk, you must also add the value of this option to the `enforce-external-domain` list of the opposite SIP Server. For more information about these options, see the *Framework 8.0 SIP Server Deployment Guide*.

Additional Information about Migration

The following information is also pertinent to the migration of the SIP Server solution 8.0.

- Be sure to review the specific issues that relate to your SIP Server solution, especially with respect to changes in configuration options. (See Chapter 27, “Changes in Configuration Options,” on [page 491](#) for details.)

Note: For an overview about migration issues, please see Chapter 1, “Migration Roadmap,” on [page 35](#) of this guide.



Chapter

26

SIP Server Solution Migration Procedures

This chapter discusses the migration procedures for release 8.0 and contains the following sections:

- [Deploying the SIP Server Solution, page 485](#)

Please refer to “Migrating from the IP Media eXchange Solution to the SIP Server Solution” on [page 437](#) for more information about previous release migration information.

Deploying the SIP Server Solution

This section describes the migration procedures for the SIP Server solution from the 7.2, 7.5, and 7.6 releases.

Note: References to SIP Server in these chapters also apply to Network SIP Server, except where noted.

Prerequisites for a 7.6 Framework Environment

SIP Server 8.0 integrates with Genesys Framework 7.6. If you are migrating your entire existing Genesys Framework to the 7.6 release of Framework, you must upgrade your Configuration Layer components to 7.6 before you migrate your SIP Server solution. If you are only upgrading your SIP Server solution, there are no special steps you need to take with your existing Configuration Layer. In both scenarios, the steps for migrating the SIP Server solution are the same.

Licensing

Prior to migrating your SIP Server solution, be aware that you need to take licensing issues into account. Starting with release 7.0, the licensing requirements for SIP Server have changed from previous releases. Please refer to the *Genesys Licensing Guide* and the *Framework 8.0 SIP Server Deployment Guide* or the *Framework 7.5 Network SIP Server Deployment Guide* for complete licensing information.

Starting with release 7.0, SIP Server refer to the license server for authentication. The new license server rules are described in the *Genesys Licensing Guide*.

Licensing Requirements for SIP Server

The following are short descriptions of the issues you must consider when deploying your new licensing for SIP Server:

- A stand-alone SIP Server serving a single site requires licenses to register all DNs it monitors. Single-site licenses are also required for all Network SIP Servers.
- SIP Servers operating with the hot standby redundancy require a special CTI HA technical license, which allows for high-availability implementations in addition to regular SIP Server licenses.
- SIP Servers performing multi-site operations require licenses that allow for such operations in addition to regular SIP Server licenses.

Licensing Prerequisites

Before starting your migration of SIP Server:

1. Obtain appropriate license files for 8.0 SIP Server.
2. Install Licensing Manager.

Other Migration Information

Related migration information that may help you migrate SIP Server is available elsewhere in this guide. See:

1. Chapter 2, “Licensing Migration,” on [page 41](#)
2. Framework migration information in Part Two of this guide
3. *Genesys 8 Interoperability Guide*
4. Information on upgrades to other prerequisite Genesys components

SIP Server Migration Procedures

Use the following two sections to assist you in performing a basic upgrade to or rollback from pre-8.0 releases to 8.0, or rollback from release 8.0 to pre-8.0 releases of SIP Server.

SIP Server Upgrade Procedures

Perform the following steps for each SIP Server Application object whose data was converted from pre-7.6 releases of Configuration Database:

1. Store the existing configuration option settings in a *.cfg file using the Export utility in Configuration Manager. Preserve this *.cfg file in a secure location in case you need to rollback later. Refer to *Framework 7.6 Configuration Manager Help* for instructions on using the Export utility.
2. Install a physical SIP Server 8.0 application. For installation instructions, refer to the *Framework 8.0 SIP Server Deployment Guide*.
3. Verify the parameters on the Start Info tab of the SIP Server Application object in Configuration Manager—the SIP Server working directory, executable name, and command-line parameters.
4. Specify any new configuration options on the Options tab of the SIP Server Application object in Configuration Manager. See the *Framework 8.0 SIP Server Deployment Guide* for complete details about options. Also see [“Configuration Options Common to All T-Servers” on page 307](#) of this guide for notes on updates to options.
5. If you have not previously used the centralized-logging and alarm-signaling capabilities of the Management Layer, but would like to do so now, add a connection to Message Server on the Connections tab of the SIP Server Application object in Configuration Manager.
6. If using Configuration Server Proxy for notifying this SIP Server about configuration changes, add Configuration Server Proxy to the Connections tab of the SIP Server Application object in Configuration Manager.

Refer to the “Start and Stop T-Server Components” chapter in the *Framework 8.0 SIP Server Deployment Guide* for startup instructions.

SIP Server Rollback Procedures

If you must return to your pre-8.0 Genesys installation:

1. Import the *.cfg file that has your pre-8.0 SIP Server configuration options to restore previously configured settings. Refer to *Framework 7.6 Configuration Manager Help* for instructions on using the Import utility.
2. Delete any new connections to server applications you have configured on the Connections tab of the SIP Server Application object in Configuration Manager.
3. Uninstall SIP Server 8.0 .

Stream Manager Migration Procedures

Use the following two sections to assist you in performing a basic upgrade to or rollback from pre-7.6 releases to 7.6 or rollback from release 7.6 to pre-7.6 releases of Stream Manager.

Stream Manager Upgrade Procedures

Perform the following steps for each Stream Manager Application object whose data was converted from pre-7.6 releases of Configuration Database:

1. Store the existing configuration option settings in a *.cfg file using the Export utility in Configuration Manager. Preserve this *.cfg file in a secure location in case you need to rollback later. Refer to *Framework 7.6 Configuration Manager Help* for instructions on using the Export utility.
2. Install a physical Stream Manager 7.6 application. For installation instructions, refer to the *Stream Manager 7.6 Deployment Guide*.
3. Verify the parameters on the Start Info tab of the Stream Manager Application object in Configuration Manager—the Stream Manager working directory, executable name, and command-line parameters.
4. Specify any new configuration options on the Options tab of the Stream Manager Application object in Configuration Manager.

Note: Many changes to configuration options have been made between release 7.5 and 7.6, including moving several options to new sections. For these moved options, changes to any existing configuration is not mandatory. Stream Manager also supports these moved options as configured in their previous sections. See “Stream Manager” on [page 497](#) in this Migration Guide and the *Stream Manager 7.6 Deployment Guide* for more information about these changes.

5. If you have not previously used the centralized-logging and alarm-signaling capabilities of the Management Layer, but would like to do so now, add a connection to Message Server on the Connections tab of the Stream Manager Application object in Configuration Manager.
6. If using Configuration Server Proxy for notifying this Stream Manager about configuration changes, add Configuration Server Proxy to the Connections tab of the Stream Manager Application object in Configuration Manager.

Refer to the “Installing and Starting Stream Manager” chapter in the *Stream Manager 7.6 Deployment Guide* for startup instructions.

Stream Manager Rollback Procedures

If you must return to your pre-7.6 Genesys installation:

1. Import the *.cfg file that has your pre-7.6 Stream Manager configuration options to restore previously configured settings. Refer to *Framework 7.6 Configuration Manager Help* for instructions on using the Import utility.
2. Delete any new connections to server applications you have configured on the Connections tab of the Stream Manager Application object in Configuration Manager.
3. Uninstall Stream Manager 7.6.

DMX Migration Procedures

SIP Server 8.0 no longer supports DMX. No upgrade is required for 8.0 SIP Server.



Chapter

27

Changes in Configuration Options

The chapter compares the changes for configuration options for the SIP Server 8.0 solution operation with earlier releases. In each case, details of the option change are given along with specific configuration instructions, when applicable. As with component configuration in Configuration Manager, the following configuration options are divided into sections.

This chapter discusses the following topics:

- [SIP Server Solution-Specific Configuration Options, page 492](#)

The options listed here are cumulative from the 7.0 release of SIP Server. Read through all the pertinent tables carefully to determine which options offer new or changed functionality for your new SIP Server solution.

Note: SIP Server is built with the T-Server Common Part (TSCP). See [“Configuration Options Common to All T-Servers” on page 307](#) for more information about changes to these options. SIP Server also supports common log options. See Table 3, “Common Option Changes,” on [page 100](#) for details.

Complete information on each supported SIP Server solution option for the current release is available in the *Framework 8.0 SIP Server Deployment Guide*; the *Stream Manager 7.6 Deployment Guide*; and the *Framework 7.5 Network SIP Server Deployment Guide*.

SIP Server Solution-Specific Configuration Options

Refer to the following tables to find specific information relating to option changes that may have occurred between the most recent 7.6 release of the SIP Server solution and your earlier release. Complete information about each supported option for the current release is available in the *Framework 8.0 SIP Server Deployment Guide*; the *Stream Manager 7.6 Deployment Guide*; and the *Framework 7.5 Network SIP Server Deployment Guide*.

Note: Prior to release 7.2, SIP Server was known as SIP Communication Server.

Changes to SIP Server Solution-Specific Configuration Options

The following SIP Server solution applications have important differences in configurations from earlier releases (see the accompanying tables for details).

- [SIP Server, page 492](#)
- [Stream Manager, page 497](#)
- [DMX, page 501](#)
- [Network SIP Server, page 501](#)

SIP Server

[Table 83](#) lists configuration options that changed between the various releases of SIP Server. If a configuration option has been replaced with another that enables the same functionality, the new option's name and location are noted.

Table 83: Option Modifications in SIP Server

Option Name	Type of Change	Occurred in Release	Details
Application Level > Options Tab > TServer Section			
sip-replaces-mode	New	8.0	
auto-logout-ready	New	8.0	
sip-ip-tos	New	8.0	
default-network-call-id-matching	New	7.6	

Table 83: Option Modifications in SIP Server (Continued)

Option Name	Type of Change	Occurred in Release	Details
map-sip-errors	New	7.6	
music-in-conference-file	New	7.6	
mwi-mode	New	7.6	
observing-routing-point	New	7.6	
parking-music	New	7.6	
set-notready-on-busy	New	7.6	
sip-dtmf-send-rtp	New	7.6	
sip-enable-call-info	New	7.6	
sip-retry-timeout	New	7.6	
sip-ring-tone-mode	New	7.6	
userdata-map-trans-prefix	New	7.6	
sip-block-headers	New	7.5	
default-video-file	New	7.5	
divert-on-ringing	New	7.5	
emergency-recording-cleanup-enabled	New	7.5	
emergency-recording-filename	New	7.5	
sip-treatments-continuous	New	7.5	
sip-initial-hold-recvonly	Removed	7.5	
sip-initial-hold-rfc3264	Removed	7.5	
sm-port	Removed	7.5	
transfer-complete-by-refer	Removed	7.5	
cpd-info-timeout	New	7.5	
delay-between-refresh-on-switchover	New	7.5	

Table 83: Option Modifications in SIP Server (Continued)

Option Name	Type of Change	Occurred in Release	Details
delay-to-start-refresh-on-switchover	New	7.5	
enforce-external-domains	New	7.5	
sip-enforce-sdp-origin-rules	Removed	7.6	
	New	7.2.1	
dual-dialog-enabled	New	7.2.1	
reject-call-incall	New	7.2.1	
reject-call-notready	New	7.2.1	
event-ringing-on-100trying	New	7.2.1	
sip-refer-to-sst-enabled	New	7.2.1	
sip-treatments-continuous	New	7.2.1	
straight-forward	New	7.2.1	
subscription-id	New	7.2.1	
transfer-complete-by-refer	New	7.2.1	
sip-initial-hold-recvonly	New	7.2.1	
handle-vsp	New	7.2.1	
reinvite-requires-hold	New	7.2	
transfer-complete-by-refer	New	7.2	
override-to-on-divert	New	7.2	
intrusion-enabled	New	7.2	
monitor-internal-calls	New	7.2	
default-monitor-scope	New	7.2	
sip-hold-rfc3264	New	7.2	
mwi-host	New	7.2	
mwi-port	New	7.2	

Table 83: Option Modifications in SIP Server (Continued)

Option Name	Type of Change	Occurred in Release	Details
mwi-domain	New	7.2	
mwi-extension-enable	New	7.2	
mwi-agent-enable	New	7.2	
mwi-group-enable	New	7.2	
sip-treatments-enabled	New	7.2	
make-call-rfc3725-flow	New	7.2	
request-uri	New	7.2	
authenticate-requests	New	7.2	
sip-address	New	7.2	
sip-sync-local-contact	Removed	7.6	
	New	7.2	
sip-sync-peer-contact	Removed	7.6	
	New	7.2	
reuse-sdp-on-reinvite	New	7.2	
sip-initial-hold-rfc3264	New	7.2	
oos-check	New	7.2	
oos-force	New	7.2	
geo-location	New	7.2	
find-trunk-by-location	New	7.2	
private-line	New	7.2	
am-detected	New	7.1	
fax-detected	New	7.1	
internal-bsns-calls	New	7.1	
unknown-bsns-calls	New	7.1	
nas-private	New	7.1	

Table 83: Option Modifications in SIP Server (Continued)

Option Name	Type of Change	Occurred in Release	Details
prd-dist-call-ans-time	New	7.1	
max-pred-req-delay	New	7.1	
expire-call-tmout	Removed	7.1	
retain-call-tmout	Removed	7.1	
Application Level > Options Tab > UPDATE, INVITE, and INFO Sections			
extensions-<n>	Renamed from Extensions-n.	7.1	Not backward compatible with 7.0.2 because of case sensitivity.
userdata-<n>	Renamed from UserData-n.	7.1	Not backward compatible with 7.0.2 because of case sensitivity.
Agent Login-Level and DN-Level > Annex Tab > TServer Section			
line-type	New	8.0	
transfer-complete-by-refer	New	8.0	
auto-logout-ready	New	8.0	
sip-early-dialog-mode	New	8.0	
charge-type	New	8.0	
capacity	New	7.6	
capacity-group	New	7.6	
cpn	New	7.6	
default-dn	New	7.6	
default-music	Modified	8.0	This option replaces the music-in-queue-file option when configured on an ACD Queue DN.
display-name	New	7.6	
music-in-queue-file	Removed	8.0	This option is no longer supported on the DN-level. Use default-music instead.
out-rule-<n>	New	7.6	
override-call-type	New	7.5	

Table 83: Option Modifications in SIP Server (Continued)

Option Name	Type of Change	Occurred in Release	Details
rfc-2976-dtmf	New	7.5	
reuse-sdp-on-reinvite	Modified	7.6	The option functionality modified.
sip-busy-type	New	7.6	
sip-ring-tone-mode	New	7.6	
sip-server-inter-trunk	New	7.6	
use-display-name	New	7.6	
userdata-map-filter	New	7.6	
agent-greeting	New	7.5	
customer-greeting	New	7.5	
force-register	New	7.5	
dual-dialog-enabled	New	7.5	
reject-call-incall	New	7.5	
reject-call-notready	New	7.5	
subscribe-presence-domain	New	7.5	
subscribe-presence-from	New	7.5	
subscribe-presence-expire	New	7.5	
subscribe-presence-	New	7.5	
enable-agent-login-presence	New	7.5	

Stream Manager

[Table 84](#) lists configuration options that changed between the various releases of Stream Manager. If a configuration option has been replaced with another that enables the same functionality, the new option's name and location are noted.

Table 84: Option Modifications in Stream Manager

Option Name	Type of Change	Occurred in Release	Details
Call Section			
call (section)	Removed	7.6	Contained options moved to a new section or removed completely.
call-protocol	Removed	7.6	Used by other components in IPMX architecture; never used by Stream Manager itself.
call-address	Renamed, moved	7.6	Renamed to rtp-address; moved to new section contact.
	New value	7.2	New \$AUTO value.
Contact Section			
contact (section)	New	7.6	
rtp-address	Modified, moved	7.6	Formerly call-address; moved from call section.
max-ports	Moved	7.6	Moved from x-conf ig section.
rtp-port	Moved	7.6	Moved from x-conf ig section.
sip-port	Moved	7.6	Moved from x-conf ig section.
	New	7.2	
Codecs Section			
codecs (section)	New	7.6	
codec-choice-priority	New	7.6	
packet-size	New	7.5	Added in release 7.5, documented in 7.6.
sip-annc-codecs	Modified, moved	7.6	Default and valid values changed; moved from x-conf ig section.
	Value order changed	7.5	Default value was changed to list the less resource-intensive values first.
	New	7.2	

Table 84: Option Modifications in Stream Manager (Continued)

Option Name	Type of Change	Occurred in Release	Details
sip-annc-transcode	New	7.6	
sip-conf-codecs	Modified, moved	7.6	Default and valid values changed; moved from x-conf ig section.
	See Details	7.5	<ul style="list-style-type: none"> • Default value was changed to list the less resource-intensive values first. • G.723 audio codec and supported video codecs can be specified
	New	7.2	
sip-g723-fmtp	New	7.6	
sip-g729-fmtp	New	7.6	
sip-h261-fmtp	Moved	7.6	Moved from x-conf ig section.
	New	7.2	
sip-h263-fmtp	Moved	7.6	Moved from x-conf ig section.
	New	7.2	
sip-h264-fmtp	See Details	7.6	Added in earlier release, documented in 7.6.
sip-http-codecs	Moved	7.6	Moved from x-conf ig section.
	New	7.2	
sip-pcap-codecs	Modified, moved	7.6	Default and valid values changed; moved from x-conf ig section.
sip-record-codecs sip-record-codec	Modified, moved	7.6	Formerly sip-record-codec; default and valid values changed; moved from x-conf ig section.
	New	7.5	
Limits Section			
limits (section)	New	7.6	

Table 84: Option Modifications in Stream Manager (Continued)

Option Name	Type of Change	Occurred in Release	Details
conf-cleanup-timeout	Moved	7.6	Moved from x-conf ig section.
	New	7.5	
file-cache-size	Moved	7.6	Moved from x-conf ig section.
	New	7.2	
lost-leg-timeout	New	7.6	
max-mixer-delay	Moved	7.6	Moved from x-conf ig section.
max-record-file-size	Moved	7.6	Moved from x-conf ig section.
max-record-silence	Moved	7.6	Moved from x-conf ig section.
max-record-time	Modified, moved	7.6	Default value changed; moved from x-conf ig section.
rtcp-inactivity-timeout	Moved	7.6	Moved from x-conf ig section.
rtp-stream-delay	Moved	7.6	Moved from x-conf ig section.
	New	7.2	
sip-http-delay	Moved	7.6	Moved from x-conf ig section.
	New	7.5	
sip-load-threshold	New	7.6	
X-Config Section			
log-trace-flags	Modified	7.6	Valid values changed.
	New	7.2	
rtp-close-delay	New	7.6	Added in earlier release, documented in 7.6.
rtp-ip-precedence	Removed	7.6	Replaced by rtp-ip-tos.
rtp-ip-tos	New	7.6	
sip-dtmf-delay	New	7.6	
sip-dtmf-duration	Modified	7.6	Default value and description changed.

Table 84: Option Modifications in Stream Manager (Continued)

Option Name	Type of Change	Occurred in Release	Details
sip-dtmf-method	New	7.6	
sip-ip-tos	New	7.6	
sip-record-all-conf	Removed	7.6	
sip-record-base-name	Removed	7.6	
sip-conf-gain	New	7.5	
sip-record-codec	New	7.5	
sip-send-info	New	7.5	
h261-annc-fmts	New	7.5	
h263-annc-fmts	New	7.5	
h264-annc-fmts	New	7.5	
beep-on-rtp-nte	New	7.5	
sip-call-record-mode	New	7.5	
audio-file-format	New	7.2	
debug-level	Removed	7.2	
-pc	Removed	7.2	
mixer-buffer-range	Removed	7.2	

DMX

DMX is no longer supported with SIP Server, starting with release 8.0.

Network SIP Server

There are no option changes in Network SIP Server between release 7.2 and release 8.0.



Part

8

IVR Interface Option Migration

The chapters in this section describe the migration process from releases 6.5 to 7.0, 7.0 to 7.1, 7.1 to 7.2, 7.2 to 7.5, 7.5 to 8.0 and from release 7.x to release 8.0 of IVR Interface Option products. They also discuss component and option changes and the other Genesys software that supports and enables IVR Interface Option functionality.

The information is divided into the following chapters:

- Chapter 28, “Introduction to IVR Interface Option Migration,” on page 505 provides background information on IVR Interface Option migration.
- Chapter 29, “Configuration Option Changes in IVR Interface Option,” on page 513 offers a list of configuration options that have changed from IVR Interface Option 6.5 to 7.0, from 7.0 to 7.1, from 7.1 to 7.2, and from 7.2 to 7.5.
- Chapter 30, “IVR Interface Option Migration Procedures,” on page 523 provides the required steps to migrate IVR Interface Option from 6.5 to 7.0, from 7.0 to 7.1, from 7.1 to 7.2, and from 7.2 to 7.5.
- Chapter 31, “Migration from Network T-Server for XML-Based GenSpec to IVR Server,” on page 529 provides the required steps to migrate from Network T-Server 6.5 for XML-Based GenSpec to IVR Server 7.x.



Chapter

28

Introduction to IVR Interface Option Migration

This chapter discusses the preliminary migration procedures for IVR Interface Option 7.0, 7.1, 7.2, 7.5, and 8.0.

This chapter discusses the following topics:

- [Preliminary Migration Procedures, page 505](#)
- [Component Compatibility, page 506](#)
- [IVR Architecture Changes, page 507](#)
- [Application Compatibility, page 509](#)
- [Component Changes, page 511](#)
- [Additional Information about Migration, page 512](#)

Preliminary Migration Procedures

Note: If you want to upgrade your operating system, you must do this before migrating your Genesys product.

The migration process includes these preliminary procedures for IVR Interface Option 7.0, 7.1, 7.2, 7.5, and 8.0:

1. Review Chapter 1, “Migration Roadmap,” on [page 35](#) of this guide.
2. Examine the component changes in “Component Changes” on [page 511](#) and the configuration option changes for IVR Interface Option 7.0, 7.1, 7.2, 7.5, and 8.0 in Chapter 29, “Configuration Option Changes in IVR Interface Option,” on [page 513](#).

Notes: Please note that the tables in Chapter 29, “Configuration Option Changes in IVR Interface Option,” on [page 513](#) discuss changes that directly affect the migration of this product only.

For complete information about “What’s New in This Release” of IVR Interface Option 7.0, 7.1, 7.2, 7.5, or 8.0 and how those releases function, please see the relevant release of the *IVR Interface Option IVR Server System Administrator’s Guide*.

For a complete list of documentation relevant to the migration of this product, see “[Reference Materials](#).”

3. Review the licensing requirements for IVR Interface Option 7.x and higher. See the *Genesys Licensing Guide*.
4. Check the interoperability of the components of IVR Interface Option 7.x and higher during the upgrade procedures. See “[Component Compatibility](#).”
5. See *Genesys Interoperability Guide* for information on the compatibility of Genesys products with various Configuration Layer Environments; Interoperability of Reporting Templates and Solutions; and *Gplus* Adapters Interoperability.
6. Review other issues pertaining to the migration of IVR Interface Option 7.x and higher. See “IVR Architecture Changes” on [page 507](#) and “Application Compatibility” on [page 509](#).

Reference Materials

- *Genesys Licensing Guide*
- The relevant *IVR Interface Option IVR Server System Administrator’s Guide*
- The relevant *IVR Interface Option IVR Driver System Administrator’s Guide* for your IVR Driver
- *Genesys Interoperability Guide*

Component Compatibility

The Genesys IVR Interface Option Server and Driver connect to and communicate with the Genesys environment, which supports telephony functions, tracks call flow, and manipulates call data.

IVR Architecture Changes

The following sections provide IVR Option 7.0, 7.1, 7.2, 7.5, and 8.0 architecture enhancements.

IVR Interface Option 8.0 Architecture Enhancements

The following features have been introduced for the drivers:

- A new API, `iLSRqUdataGetAll`, will return all known key-value pairs.
- The `iLWatch` API must be used during times on slow activity or inactivity to allow Keep-Alive messages to IVR Server.
- A new API, `iLConnectionOpenCfgServer80`, allows the definition of client-side ports and a backup Configuration Server.
- High Availability mode communication with IVR Server is now available.
- A new `getreply_with_location` configuration parameter can ask for the target switch to be returned.
- TLS is now supported.
- Client-side ports are now supported.
- A new API, `iLGetParmValue`, returns optional parameters.
- `iLConnectionOpenConfigServer` can be configured to return the value `false` instead of exiting when a connection to Configuration Server cannot be made.
- Configurable driver statistics are now available.

IVR Interface Option 7.5 Architecture Enhancements

With MPS 3.0, the Genesys IVR Driver functions in the *N+1 redundancy mode*. This is a Nortel system backup configuration in which one node serves as a backup (secondary) node for multiple operational (primary) nodes. You must install and configure the Genesys IVR Driver on each node. The redundant driver then functions as in Warm Standby mode. For more information, see the *Media Processing Server Series System Reference Manual*.

Note: To take advantage of the full range of IVR Driver 7.5 functions, you must use IVR Server 7.5, Genesys Framework 7.5, and Genesys 7.5 licensing.

IVR Interface Option 7.2 Architecture Enhancements

- A new feature has been introduced into some of the IVR Drivers to maximize service availability through the use of Agent state manipulation.

- For IVR-In-Front configurations, IVR Server can report `EventDNOutOfService` and `EventDNBackInService` for DNs associated with IVR Ports. This feature can be used to prevent calls from being routed to an IVR in cases where the IVR Driver is not available to process new calls.

Note: This feature is not supported for Load Balanced IVR Server configurations. It is available for stand-alone or Warm Standby configurations of IVR-In-Front mode configurations only.

- IVR Server can logout the agent assigned to an IVR Port when the IVR Port configuration object is disabled, and login the agent assigned to an IVR Port when the IVR Port configuration option is enabled.
This feature allows individual IVR Ports to be taken out of service and allows all of the IVR Ports associated with an IVR object to be disabled when the IVR configuration object is disabled.
- An IVR Server instance can be taken out of service without impacting existing calls using the new flow control feature. By setting the new configuration option `flow-control` in section `IServer` to value `true`, IVR Server will inform connected IVR Drivers that no new calls from this IVR will be accepted.
- IVR Server supports Unicode in user data provided by the GVP platform. Unicode character data is transcoded by IVR Server into a specific character encoding prior to attaching user data to a call. IVR Server transcodes user data from this specific character encoding back to Unicode when providing user data to the GVP platform. The resultant Unicode must be limited to no more than two byte unicodes.

Note: To take advantage of the full function of IVR Server 7.2, Genesys recommends that you use Framework 7.2 and IVR Driver 7.2.

IVR Interface Option 7.1 Architecture Enhancements

- IVR Server can now be configured to specify the work mode at the time of Agent Login.
- IVR Server (in IVR Network T-Server mode) now supports the Network Call Monitoring feature which allows the CTI-less T-Server of the Expert Contact Solution to receive Call Monitoring Events such as call created, call deleted, call party added, and call party deleted.
- IVR Server now supports the predictive dialing method used by Genesys outbound components: Outbound Contact Solution and Voice Callback Solution.
- The IVR Configuration Wizard now supports configuration of the IVR Server in IVR Network T-Server mode.

Note: To take advantage of the full function of IVR Server 7.1, Genesys recommends that you use Framework 7.1 and IVR Driver 7.1.

IVR Interface Option 7.0 Architecture Enhancements

With release 7, the IVR Interface Option architecture has been enhanced to include these features:

- In addition to the IVR-In-Front and the IVR-Behind-Switch configuration modes, IVR Server can now be configured in IVR Network T-Server mode. This mode provides functionality previously available in the Network T-Server 6.5 for XML-Based GenSpec product offering.
- The Genesys IVR Interface Option Wizard is available for IVR Interface Option 7.0. The IVR Server and IVR Driver applications can be configured using the wizard. For the IVR Drivers for Aspect (UnixWare only) and CONVERSANT, you can use the wizard to configure ports and DNSs on the IVR object, but not on the IVR_Driver application itself.
- The IVR Driver must still be installed manually. See the installation and configuration instructions provided in the IVR Server and IVR Driver *System Administrator's Guides*.

Application Compatibility

The following sections indicate application compatibility issues to be considered when migrating to a new release.

When Migrating from 7.x to 8.0

Applications migrating to use the 8.0 I-Library, must now ensure that they call the `ilWatch()` function periodically to provide cycles to the I-Library.

When Migrating from 6.5 to 7.0, 7.1, 7.2 or 7.5

User applications written to use Genesys IVR Interface Option 6.5 are compatible with IVR Interface Option 7.0, 7.1, 7.2, or 7.5. For example, scripts assembled in Genesys IVR Interface Option 6.5 are compatible with IVR Interface Option 7.0, 7.1, 7.2, or 7.5 with minimal changes. 6.1 Drivers are not compatible with 6.5+ IVR Server.

- For the `GetCallInfo` function, if a value is not available for a given key (like ANI), the default behavior is that the string `NULL` is returned for that key. In IVR Driver 6.5, the string `Not Available` was returned instead. If your applications use the string `Not Available`, you can keep the 6.5 behavior. For all 7.0, 7.1, 7.2, or 7.5 IVR Drivers *except* those on UnixWare platforms, on the `Options` tab of the IVR_Driver application's `Properties` dialog box, set the `compat65` option to `yes` in the `ivr_server_interface` section. For the IVR Drivers for Aspect (UnixWare only) and CONVERSANT, set the `compat65` option to `yes` in the `DataTransport` section of the `Annex` tab on the IVR object's `Properties` dialog box.

- For the `UDataGetKVP` function, if a key is given that is not in the current call information, the default behavior is that the string `NoMatch` is returned. In IVR Driver 6.5, the string `Error NoMatch` was returned instead. If your applications use the string `Error NoMatch`, you can keep the 6.5 behavior. For all 7.0, 7.1, 7.2, or 7.5 IVR Drivers *except* those on UnixWare platforms, on the `Options` tab of the `IVR_Driver` application's `Properties` dialog box, set the `compat65` option to `yes` in the `ivr_server_interface` section. For the IVR Drivers for Aspect (UnixWare only) and CONVERSANT, set the `compat65` option to `yes` in the `DataTransport` section of the `Annex` tab on the IVR object's `Properties` dialog box.
- The IVR Server can now be configured to participate in Genesys centralized logging. IVR Driver and IVR Server log events are available through the Genesys Message Server and the Solution Control Interface when you configure centralized logging. See the *IVR Interface Option 7.x IVR Server System Administrator's Guide* for information on how to configure centralized logging. The log events are available in the latest *Combined Log Events Help*, which you can download from the Genesys Technical Support website at <http://genesyslab.com/support>.
- The `StatGet` function is not supported in IVR Interface Option 7.x and higher. You should use `StatPeek` instead. For more information, see the description for `StatPeek` in the *System Administrator's Guide* for your IVR Driver or in the *Genesys Developer Program 7.x IVR SDK XML Developer's Guide*.
- The `RouteDone` function is not supported in IVR Interface Option 7.x and higher. Instead, the IVR Server sends a `route used` message to the Universal Routing Server (URS) automatically. For more information, see the description of the `RouteRequest` function in the *System Administrator's Guide* for your IVR Driver or in the *Genesys Developer Program 7.x IVR SDK XML Developer's Guide*.
- Colons in user data keys can be used when attaching user data, but not when retrieving user data.
- You can use the IVR Interface Option Wizard to define and configure IVRs, ports, and DNSs. This wizard can be used to configure an entire range of ports and DNSs at the same time, rather than individually. The manual configuration steps, which are located in the *IVR Interface Option 7.x IVR Server System Administrator's Guide*, can still be used to configure IVR ports one at a time. For the IVR Drivers for Aspect (UnixWare only) and CONVERSANT, you can use the wizard to configure ports and DNSs on the IVR object, but not on the `IVR_Driver` application.
- A new `IVR_Driver` application must be configured for use with IVR Driver and IVR Server for releases 7.0, 7.1, 7.2, or 7.5. This new application is not available or required for the IVR Driver for Aspect CSS on UnixWare or the IVR Driver for CONVERSANT.

- New configuration steps are required for the IVR Driver configuration file. See the *System Administrator's Guide* for your IVR Driver for more information.
- New statistics for retrieving the position in queue and the estimated wait time for calls are available for IVR Driver 7.0, 7.1, 7.2, and 7.5 through attached user data from URS. See the *Universal Routing 7 Reference Guide* for more information.
- IVR Library and IVR Server log events are now available through the Genesys Message Server when you configure centralized logging. To enable this feature in your IVR Driver, you must use the new configuration parameters in the IVR Driver configuration file. These new logging functions are not available for the IVR Drivers for Aspect CSS on UnixWare and CONVERSANT.
- Genesys G7 licensing is required for IVR Server 7.0, 7.1, 7.2, and 7.5. IVR Server 7.0, 7.1, 7.2, and 7.5 support licensing for IVR-In-Front, IVR-Behind-Switch, IVR Network T-Server, and IVR Network T-Server Routing configuration modes. For more information, see the *Genesys Licensing Guide* and the T-Server common configuration options appendix in the *IVR Interface Option 7.x IVR Server System Administrator's Guide*.
- LCA (Local Control Agent) must be installed on the same machine as the IVR and the IVR Driver for the IVR Drivers 7.0, 7.1, 7.2, and 7.5 to run. This does not apply to the IVR Drivers 7.0, 7.1, 7.2, or 7.5 for Aspect CSS on UnixWare and CONVERSANT.

Note: IVR Driver 7.x requires the use of IVR Server 7.x and Genesys Framework 7.x. Genesys 7.x licensing is also required.

For other restrictions, see the Release Notes for the IVR Server and your IVR Driver for release 7.0, 7.1, 7.2, or 7.5.

Component Changes

The following sections indicate component changes for releases.

- 8.0 Release** In release 8.0 the I-Library component is available as a separate download for patch releases.
- 7.5 Release** There were no component changes from release 7.2 to 7.5.
- 7.2 Release** There were no component changes from release 7.1 to 7.2.
- 7.1 Release** There were no component changes from release 7.0 to 7.1.
- 7.0 Release** The following items have changed from release 6.5 to 7:

- **Licensing**—IVR Server 7 requires G7 licensing. For more information, see the *Genesys Licensing Guide* and the T-Server common configuration options appendix in the *IVR Interface Option 7 IVR Server System Administrator's Guide*.

Additional Information about Migration

Migrating to 7.0, 7.1, 7.2, 7.5, or 8.0

The following information is also pertinent to the migration of IVR Interface Option 7.0, 7.1, 7.2, 7.5, or 8.0:

- IVR Interface 6.1 must be migrated first to IVR Interface Option release 6.5 and then to release 7.0, 7.1, 7.2, 7.5, or 8.0.

Notes: Prior to IVR Interface Option 7.1, all Genesys supplied IVR Drivers were packaged on a single CD. With IVR Interface Option 7.1, 7.2, and 7.5, each vendor Driver is on a separate CD; therefore, if you have multiple vendor IVR types, you will need to obtain one CD for each of your IVR types. With IVR Interface Option 8.0, all Genesys supplied IVR Drivers are packaged on a single CD.

For an overview about migration issues, please see Chapter 1, “Migration Roadmap,” on [page 35](#).



Chapter

29

Configuration Option Changes in IVR Interface Option

This chapter lists the changes in configuration options from IVR Interface Option between successive releases from 6.5 onwards. In each case, details of the option change are given along with specific configuration instructions, when applicable. As with component configuration in Configuration Manager, the following configuration options are divided into sections.

The options listed here are cumulative from the 6.5 release of IVR Interface Option. Read through all the pertinent tables carefully to determine which options offer new or changed functionality for your IVR Server and IVR Driver.

This chapter discusses the following topics:

- [IVR Server Configuration Options, page 513](#)
- [IVR Driver Configuration Options, page 515](#)

Complete information on each configuration option supported for IVR Interface Option for the current release is available in the relevant *IVR Interface Option IVR Server System Administrator's Guide*.

IVR Server Configuration Options

This section identifies changes in configuration options between successive versions of IVR Server.

IVR Server Changes from 7.5 to 8.0

No changes are required for IVR Server 8.0 operation. For details about new features, see the *IVR Interface Option 8.0 IVR Server System Administrator's Guide*.

IVR Server Changes from 7.2 to 7.5

No changes are required for IVR Server 7.5 operation. For details about new features, see the *IVR Interface Option 7.5 IVR Server System Administrator's Guide*.

IVR Server Changes from 7.1 to 7.2

No changes are required for IVR Server 7.2 operation. For details about new features, see the *IVR Interface Option 7.2 IVR Server System Administrator's Guide*.

IVR Server Changes from 7.0 to 7.1

No changes are required for IVR Server 7.1 operation. For details about new features, see the *IVR Interface Option 7.1 IVR Server System Administrator's Guide*.

IVR Server Changes from 6.5 to 7.0

This section discusses new and enhanced configuration options required for IVR Server 7.0 operation. For existing customers, where a 6.5 configuration option has been updated for release 7, details of the update are given along with specific configuration instructions, when applicable.

[Table 85](#) lists configuration options that have changed between 6.5 and 7.0 releases of IVR Interface Option. If a configuration option has been replaced with another that enables the same functionality, the new option name and section (if applicable) are noted.

Note: When options are described in [Table 85](#) as Moved from one chapter to another, both chapters are in the *IVR Interface Option 7 IVR Server System Administrator's Guide*.

Table 85: Option Changes 6.5 to 7.0—IVR Server

Option Name	Type of Change	Details
DataTransport Section		
See “IVR Driver Changes from 7.0 to 7.1” on page 516 .		
extrouter		
Note: You should only configure external routing on the TServer_IVR application if you are using the IVR-In-Front or dual (IVR-In-Front and IVR-Behind-Switch) configuration mode. If you are using only the IVR-Behind-Switch configuration mode, external routing should be configured on the premise T-Server application instead.		
InFront Section		
UseQueue	New	No default value. Valid value is any valid ACD queue name.
IServerGLMSap Section		
checkout-interval	New Required	Valid values are in the range of 600 seconds to 3600 seconds.
operation-mode	New Required	Valid Values: IVR, NTS.

IVR Driver Configuration Options

This section identifies changes in configuration options between various versions of IVR Drivers.

IVR Driver Changes from 7.5 to 8.0

[Table 86](#) outlines the new and enhanced functionality of options for 8.0 IVR Driver. For details about new features, see the *IVR Interface Option 8.0 IVR Server System Administrator’s Guide*.

Table 86: Option Changes 7.5 to 8.0—IVR Driver

Option Name	Type of Change	Details
iserver_mode_hotstandby	New	
getreply_with_location	New	
cfg-server-response	New	

Table 86: Option Changes 7.5 to 8.0—IVR Driver (Continued)

Option Name	Type of Change	Details
load_sharing_iservers_client_hosts	New	
load_sharing_iservers_client_ports	New	
log_print_statistics	New	
log_print_statistics_reset	New	

IVR Driver Changes from 7.2 to 7.5

No changes are required for IVR Driver 7.5 operation. For details about new features, see the *IVR Interface Option 7.5 IVR Server System Administrator's Guide*.

IVR Driver Changes from 7.1 to 7.2

No changes are required for IVR Driver 7.2 operation. For details about new features, see the *IVR Interface Option 7.2 IVR Server System Administrator's Guide*.

IVR Driver Changes from 7.0 to 7.1

This section discusses new and enhanced configuration options required for IVR Driver 7.1 operation. Because of limitations on the UnixWare platform, the IVR Drivers 7.1 for Aspect CSS on UnixWare and for CONVERSANT use different configuration options than the rest of the release 7.1 IVR Drivers.

Configuration Option Changes from 7.0 to 7.1 —Aspect (UnixWare Only) and CONVERSANT

[Table 87](#) shows the configuration options that have changed between the 7.0 and 7.1 releases of the IVR Drivers for Aspect CSS on UnixWare and CONVERSANT.

Table 87: Option Changes 7.0 to 7.1—IVR Drivers for Aspect (UnixWare Only) and CONVERSANT

Option Name	Type of Change	Details
DataTransport Section		
compat65	New	Valid Values: yes, no.

Table 87: Option Changes 7.0 to 7.1—IVR Drivers for Aspect (UnixWare Only) and CONVERSANT (Continued)

Option Name	Type of Change	Details
log_file_backup_name_short	Removed	
time_hb_is	Removed	

Configuration Option Changes from 7.0 to 7.1 —Edify

Table 89 on [page 519](#) shows the configuration options that have changed between the 7.0 and 7.1 releases of the IVR Driver for Edify. Also, the IVR Driver for Edify is configured to automatically run as a Windows Service in release 7.1.

Configuration Option Changes from 7.0 to 7.1 —Microsoft Speech Server

The 7.0 release of the IVR Driver for Microsoft Speech Server contained the same functions as the 7.0 UnixWare drivers. The 7.1 release of the IVR Driver for Microsoft Speech Server has been upgraded to provide the same functions as the other (non-UnixWare) drivers.

[Table 88](#) lists the options that have changed since the 7.0 release for the IVR Driver for Microsoft Speech Server. If a configuration option has been replaced with another that enables the same functionality, the new option name and section (if applicable) are noted.

Table 88: Option Changes 7.0 to 7.1—Microsoft Speech Server

Option Name	Type of Change	Details
ivr_server_interface Section		
compat65	New	Valid Values: yes, no.
load_sharing_isservers	Changed Moved	For release 7.1, the list must contain <i>all</i> load-sharing I-Servers, including the one that will serve as the primary (in the case of Warm Standby). Option and documentation moved from DataTransport section to new ivr_server_interface section.

Table 88: Option Changes 7.0 to 7.1—Microsoft Speech Server (Continued)

Option Name	Type of Change	Details
time_recon_is	Changed Moved	Valid values changed to any integer greater than or equal to 1000. Option and documentation moved from DataTransport section to new ivr_server_interface section.
log_content Section		
log_dbg	Removed	
log_file_backup_amount	Removed	
log_file_backup_name_short	Removed	
log_file_name	Removed	
log_file_size	Removed	
print_options	Removed	
time_hb_is	Removed	
log_print_level	New	Specifies the level of logging for debug messages. Valid Values: flow, xml, debug, detail, none.
log_print_date	Moved	Option and documentation moved from DataTransport section to new log_content section.
log_print_hb	Moved	Option and documentation moved from DataTransport section to new log_content section.
log_print_name	Changed Moved	Default value changed from No to Yes. Option and documentation moved from DataTransport section to new log_content section.
log_print_recv	Moved	Option and documentation moved from DataTransport section to new log_content section.
log_print_send	Moved	Option and documentation moved from DataTransport section to new log_content section.
log_print_time	Moved	Option and documentation moved from DataTransport section to new log_content section.

Table 88: Option Changes 7.0 to 7.1—Microsoft Speech Server (Continued)

Option Name	Type of Change	Details
log_print_time_ms	Changed Moved	Default value changed from No to Yes. Option and documentation moved from DataTransport section to new log_content section.
log_print_timeouts	Moved	Option and documentation moved from DataTransport section to new log_content section.
log_print_adata	Changed Moved	Default value changed from Yes to No. Option and documentation moved from DataTransport section to new log_content section.

Configuring the .ini File for IVR Driver for Microsoft Speech Server

For the IVR to communicate with the IVR Driver and the IVR Server, you must configure the `MSSSIsvr.ini` file. Several of the options in this file have changed from release 7.0 to 7.1.

- For the 7.0 configuration instructions, see *IVR Interface Option 7 IVR Driver for Microsoft Speech Server System Administrator's Guide*.
- For the 7.1 configuration instructions, see *IVR Interface Option 7.1 IVR Driver for Microsoft Speech Server System Administrator's Guide*.

Configuration Option Changes from 7.0 to 7.1 —All Other Drivers

[Table 89](#) shows the configuration option changes from release 7.0 to release 7.1 for these IVR Drivers:

- IVR Driver for Aspect on Solaris
- IVR Driver for MPS
- IVR Driver for Show N Tel
- IVR Driver for WVR for AIX
- IVR Driver for WVR for Windows

Table 89: Option Changes 7.0 to 7.1—All Non-UnixWare IVR Drivers

Option Name	Type of Change	Details
ivr_server_interface Section		
compat65	New	Valid Values: yes, no.

IVR Driver Changes from 6.5 to 7.0

This section discusses new and enhanced configuration options required for IVR Driver 7.0 operation. Because of limitations on the UnixWare platform, the IVR Drivers 7.0 for Aspect (UnixWare only) and CONVERSANT use different configuration options than the rest of the release 7.0 IVR Drivers.

Configuration Option Changes from 6.5 to 7.0 —Aspect (UnixWare Only) and CONVERSANT

Table 90 lists the options that have changed since the 6.5 release for the IVR Drivers for Aspect CSS on UnixWare and CONVERSANT. If a configuration option has been replaced with another that enables the same functionality, the new option name and section (if applicable) are noted.

Table 90: Option Changes 6.5 to 7.0—Aspect (UnixWare Only) and CONVERSANT

Option Name	Type of Change	Details
DataTransport Section		
log_file_backup_name_short	Removed	
time_hb_is	Removed	
log_print_level	New	Valid Values: flow, xml, debug, detail, none.
log_file_name	Changed	Default value changed from No default value to con.
log_file_backup_amount	Changed	Default value changed from No default value to 0.
time_recon_is	Changed	Valid values changed to any integer greater than or equal to 1000.
log_print_name	Changed	Default value changed from No to Yes.
log_print_time_ms	Changed	Default value changed from No to Yes.
log_print_adata	Changed	Default value changed from Yes to No.
log_dbg	Changed	Changes take effect After Driver is restarted, and not Immediately.

Configuration Option Changes from 6.5 to 7.0 —All Other Drivers

Because IVR Driver 7.0 requires the new `IVR_Driver` application, all IVR Drivers 7.0 except Aspect CSS on UnixWare and CONVERSANT require new configuration options and the reconfiguration of some existing options. Changes in this section apply to the IVR Driver for Aspect on Solaris platforms. Table 91 on [page 521](#) lists the options that are new or have changed since the 6.5 release. If a configuration option has been replaced with another that enables the same functionality, the new option name and section (if applicable) are noted.

Note: Configuration options that were previously configured on the `Annex` tab of the IVR object are now configured on the `Options` tab of the new `IVR_Driver` application. New options are also configured on the `Options` tab of the `IVR_Driver` application.

Table 91: Option Changes 6.5 to 7.0—All Other Drivers

Option Name	Type of Change	Details
ivr_server_interface Section		
<code>load_sharing_isservers</code>	Changed Moved	For release 7, the list must contain <i>all</i> load-sharing I-Servers, including the one that will serve as the primary (in the case of Warm Standby). Option and documentation moved from <code>DataTransport</code> section to new <code>ivr_server_interface</code> section.
<code>time_recon_is</code>	Changed Moved	Valid values changed to any integer greater than or equal to 1000. Option and documentation moved from <code>DataTransport</code> section to new <code>ivr_server_interface</code> section.
log_content Section		
<code>log_dbg</code>	Removed	
<code>log_file_backup_amount</code>	Removed	
<code>log_file_backup_name_short</code>	Removed	
<code>log_file_name</code>	Removed	
<code>log_file_size</code>	Removed	
<code>print_options</code>	Removed	

Table 91: Option Changes 6.5 to 7.0—All Other Drivers (Continued)

Option Name	Type of Change	Details
time_hb_is	Removed	
log_print_level	New	Specifies the level of logging for debug messages. Valid Values: flow, xml, debug, detail, none.
log_print_date	Moved	Option and documentation moved from DataTransport section to new log_content section.
log_print_hb	Moved	Option and documentation moved from DataTransport section to new log_content section.
log_print_name	Changed Moved	Default value changed from No to Yes. Option and documentation moved from DataTransport section to new log_content section.
log_print_recv	Moved	Option and documentation moved from DataTransport section to new log_content section.
log_print_send	Moved	Option and documentation moved from DataTransport section to new log_content section.
log_print_time	Moved	Option and documentation moved from DataTransport section to new log_content section.
log_print_time_ms	Changed Moved	Default value changed from No to Yes. Option and documentation moved from DataTransport section to new log_content section.
log_print_timeouts	Moved	Option and documentation moved from DataTransport section to new log_content section.
log_print_adata	Changed Moved	Default value changed from Yes to No. Option and documentation moved from DataTransport section to new log_content section.



Chapter

30

IVR Interface Option Migration Procedures

This chapter discusses the migration procedures between successive releases from 6.5 onwards. It contains the following sections:

- [Upgrading IVR Server, page 523](#)
- [Upgrading IVR Drivers, page 525](#)

Upgrading IVR Server

This section provides instructions on how to migrate and rollback between various versions of IVR Server.

Upgrading from 7.5 to 8.0

There are no configuration changes required when migrating from 7.5 to 8.0.

Upgrading from 7.2 to 7.5

There are no configuration changes required when migrating from 7.2 to 7.5.

Upgrading from 7.1 to 7.2

There are no configuration changes required when migrating from 7.1 to 7.2.

Upgrading from 7.0 to 7.1

There are no configuration changes required when migrating from 7.0 to 7.1.

Upgrading from 6.5 to 7.x

- Procedures**
1. Store the existing configuration option settings in a *.cfg file using the Export utility in Configuration Manager. Preserve this *.cfg file in a secure location in case of rollback. Refer to the *Framework 7.x Configuration Manager Help* for instructions on using the Export utility.
 2. Use the IVR Interface Option Wizard in configure mode in Configuration Manager to upgrade existing IVR Interface Option 6.5 applications to release 7.0, 7.1, 7.2, or 7.5. If you want to preserve your 6.5 applications, you can use the Genesys Wizard Manager to create new applications for release 7.0, 7.1, 7.2, or 7.5. For more information on how to use these wizards, see the *IVR Interface Option 7.x IVR Server System Administrator's Guide*.
 3. If you have not previously used the centralized-logging and alarm-signaling capabilities of the Management Layer, but would like to do so now, add a connection to Message Server on the **Connections** tab of the TServer_IVR application in Configuration Manager.
 4. If you use Configuration Server Proxy for notifying the IVR Server about configuration changes, add Configuration Server Proxy to the **Connections** tab of the TServer_IVR application in Configuration Manager.

**Rollback
Instructions:
7.x or 8.0 to 6.5**

If returning to your 6.5 Genesys installation:

1. To restore previously configured settings, import the *.cfg file into which you exported IVR Server 6.5 configuration options. Refer to the relevant *Framework Configuration Manager Help* for instructions on using the Import utility.
2. Delete any new connections to server applications you have configured on the **Connections** tab of the TServer_IVR and I-Server applications in Configuration Manager.
3. Delete the I-Server application and any IVR or IVR port objects that were created for this installation.

Note: If your 6.5 configuration relies on any of these connections, do not delete them.

4. Uninstall release 7.x or higher of the TServer_IVR application.

Upgrading IVR Drivers

This section provides instructions on how to migrate and rollback between various versions of IVR Drivers.

Because of limitations on the UnixWare platform, the IVR Drivers for Aspect CSS on UnixWare and CONVERSANT do not support the new functions in IVR Driver 7.x or 8.0. Therefore, these two drivers have different upgrade procedures than the rest of the release 7.x and 8.0 IVR Drivers.

Note: Prior to IVR Interface Option 7.1, all Genesys supplied IVR Drivers were packaged on a single CD. From IVR Interface Option 7.1, each vendor Driver is on a separate CD, therefore if you have multiple vendor IVR types, you will need to obtain one CD for each of your IVR types, until Genesys 8.0 at which time all drivers are placed onto one CD.

**IVR Driver 7.0 to 7.1, 7.2, 7.5 or 8.0 Upgrade Procedures,
or from 7.1 to 7.2, 7.5, or 8.0 Upgrade Procedures,
or from 7.2 to 7.5, or 8.0 Upgrade Procedures,
or from 7.5 to 8.0 Upgrade Procedures
—Aspect CSS on UnixWare and CONVERSANT**

None required.

Note: Aspect CSS Driver is not released in 8.0.

**IVR Driver 7.1, 7.2, 7.5, or 8.0 to 7.0 Rollback Instructions,
or from 7.2, 7.5, or 8.0 to 7.1 Rollback Instructions,
or from 7.5 or 8.0 to 7.2 Rollback Instructions,
or from 8.0 to 7.5 Rollback Instructions
—Aspect CCS on UnixWare and CONVERSANT**

To return to your 7.0, 7.1, 7.2, or 7.5 Genesys installation:

- Uninstall IVR Driver 7.1, 7.2, 7.5, or 8.0.
- Reinstall IVR Driver 7.0, 7.1, 7.2, or 7.5.

**IVR Driver 7.0 to 7.1, 7.2 or 7.5 Upgrade Procedures,
or from 7.1 to 7.2 or 7.5 Upgrade Procedures,
or from 7.2 to 7.5 Upgrade Procedures
—Microsoft Speech Server**

1. Copy and rename the existing configuration file for your IVR Driver 7.0, 7.1, or 7.2. Customize the IVR Driver 7.1, 7.2, or 7.5 configuration file using the instructions provided in the *IVR Interface Option 7.x IVR Driver for Microsoft Speech Server System Administrator's Guide*.

2. Uninstall the Customer Test Package (CTP) for release 7.0, 7.1, or 7.2.
3. Uninstall the IVR Driver for Microsoft Speech Server 7.0, 7.1, or 7.2.
4. Since the `IVR_Driver` application is new for release 7.x and required, you must create a new `IVR_Driver` application. You can use the Genesys Wizard Manager to create an `IVR_Driver` application, or you can use the IVR Interface Option Wizard in configure mode in Configuration Manager to upgrade your existing IVR objects to release 7.1, 7.2, or 7.5. Creating the `IVR_Driver` application is part of the wizard upgrade process. For more information on how to use these wizards, see the *IVR Interface Option 7.x IVR Server System Administrator's Guide*.
5. Install the Customer Test Package (CTP) for release 7.1, 7.2, or 7.5.
6. Install release 7.1, 7.2, or 7.5 of the IVR Driver for Microsoft Speech Server.

Note: Microsoft Speech Server Driver is not released in 8.0.

**IVR Driver 7.1, 7.2, or 7.5 to 7.0 Rollback Instructions,
or from 7.2 or 7.5 to 7.1 Rollback Instructions,
or from 7.5 to 7.2 Rollback Instructions
—Microsoft Speech Server**

To return to your 7.0, 7.1, or 7.2 Genesys installation:

1. Stop the IVR Driver for Microsoft Speech Server 7.1, 7.2, or 7.5.
2. Stop Internet Information Services (IIS) on the Microsoft Web Server.
3. Back up the Web Server system to preserve your IVR Driver for Microsoft Speech Server 7.0, 7.1, or 7.2 profiles.
4. Uninstall the IVR Driver for Microsoft Speech Server and the Customer Test Package (CTP) for release 7.1, 7.2, or 7.5.
5. Install the IVR Driver for Microsoft Speech Server and CTP for release 7.0, 7.1, or 7.2.
6. Configure the IVR Driver for Microsoft Speech Server 7.0, 7.1, or 7.2 and the CTP 7.0, 7.1, or 7.2 using the instructions in the *IVR Interface Option 7.x IVR Driver for Microsoft Speech Server System Administrator's Guide*.

Note: Microsoft Speech Server Driver is not released in 8.0.

**IVR Driver 7.0 to 7.1, 7.2, 7.5, or 8.0 Upgrade Procedures,
or from 7.1 to 7.2 7.5 or 8.0 Upgrade Procedures,
or from 7.2 to 7.5 or 8.0 Upgrade Procedures,
or from 7.5 to 8.0 Upgrade Procedures
—All Other Drivers**

1. Copy and rename the existing configuration file for your IVR Driver.

2. Customize the IVR Driver configuration file using the instructions provided in the relevant driver's *System Administrator's Guide*.
3. Install and configure IVR Driver using the instructions provided in the relevant driver's *System Administrator's Guide*.

Note: Envoy Driver and WVR for Windows Driver are not released in 8.0.

**IVR Driver 7.1, 7.2, 7.5, or 8.0 to 7.0 Rollback Instructions,
or from 7.2, 7.5, or 8.0 to 7.1 Rollback Instructions,
or from 7.5 or 8.0 to 7.2 Rollback Instructions,
or from 8.0 to 7.5 Rollback Instructions
—All Other Drivers**

To return to your 7.0, 7.1, 7.2, or 7.5 Genesys installation:

1. Restore the renamed IVR Driver 7.0, 7.1, 7.2, or 7.5 configuration file to the correct file name.
2. Uninstall the newer IVR Driver.
3. Reinstall the older IVR Driver.

Note: Envoy Driver and WVR for Windows Driver are not released in 8.0.

Upgrading IVR Driver from 6.5 to 7.x

Because of limitations on the UnixWare platform, the IVR Drivers for Aspect CSS on UnixWare and CONVERSANT do not support the new functions in IVR Driver 7.0, 7.1, 7.2, or 7.5. Therefore, these two drivers have different upgrade procedures than the rest of the release 7.x IVR Drivers.

**IVR Driver 6.5 to 7.x Upgrade Procedures
—Aspect (UnixWare Only) and CONVERSANT**

None required.

**IVR Driver 7.x to 6.5 Rollback Instructions
—Aspect CSS on UnixWare and CONVERSANT**

If returning to your 6.5 Genesys installation:

- Uninstall IVR Driver 7.x.
- Reinstall IVR Driver 6.5.

IVR Driver 6.5 to 7.x Upgrade Procedures

—All Other Drivers

1. Copy and rename the existing configuration file for your IVR Driver 6.5. Customize the IVR Driver 7.x configuration file using the instructions provided in the *System Administrator's Guide* for your IVR Driver 7.x.
2. Since the `IVR_Driver` application is new for release 7.x and required, you must create a new `IVR_Driver` application. You can use the Genesys Wizard Manager to create an `IVR_Driver` application, or you can use the IVR Interface Option Wizard in configure mode in Configuration Manager to upgrade your existing IVR objects to release 7.x. Creating the `IVR_Driver` application is part of the wizard upgrade process. For more information on how to use these wizards, see the *IVR Interface Option 7.x IVR Server System Administrator's Guide*.

IVR Driver 7.x to 6.5 Rollback Instructions

—All Other Drivers

If returning to your 6.5 Genesys installation:

1. Restore the renamed IVR Driver 6.5 configuration file to the correct file name.
2. Delete any new connections to `IVR_Driver` applications you have configured on the `Connections` tab of the `TServer_IVR` application in Configuration Manager.
3. Delete the `IVR_Driver` application and any IVR or IVR port objects that were created for this installation.

Note: If your 6.5 configuration relies on any of these connections, do not delete them.

4. Uninstall IVR Driver 7.x.
5. Reinstall IVR Driver 6.5.



Chapter

31

Migration from Network T-Server for XML-Based GenSpec to IVR Server

This chapter describes how to migrate Network T-Server 6.5 for XML-Based GenSpec to IVR Server 7.0, 7.1, 7.2, 7.5, or 8.0. Information in this chapter is divided among the following topics:

- [Migration Overview, page 529](#)
- [General Information, page 530](#)
- [Configuration Changes, page 531](#)
- [IVR XML Implementations, page 533](#)
- [Message Specification Migration, page 533](#)
- [Message Changes, page 534](#)

Note: Network T-Server 6.5 for XML-Based GenSpec is also called NTS GenSpec in this chapter.

Migration Overview

To migrate from NTS GenSpec to IVR Server 7.0, 7.1, 7.2, 7.5, or 8.0, follow these general steps:

- Verify that you are using a supported release of the required products listed in [Table 92](#).
- Install IVR Server 7.0, 7.1, 7.2, 7.5, or 8.0. See the relevant *IVR Interface Option IVR Server System Administrator's Guide* for information on how to install and configure IVR Server.
- In Configuration Manager, make the configuration option changes described in “Configuration Changes” on [page 531](#).

- Make the XML protocol changes described in “Message Changes” on [page 534](#).

General Information

Component Compatibility

The Genesys 7.0, 7.1, 7.2, 7.5, or 8.0. IVR Interface Option Server and Driver connect to and communicate with the Genesys environment, which supports telephony functions, tracks call flow, and manipulates call data.

Before you can configure IVR Interface Option 7.0, 7.1, 7.2, 7.5, or 8.0, a supported level of each of the Genesys products shown in [Table 92](#) must be installed and running.

Table 92: Required Products and Supported Releases

Required Product	Supported Release
Genesys Framework	<ul style="list-style-type: none"> • 6.1 • 6.5 • 7.0 • 7.1 • 7.2 • 7.5 • 8.0
Premise T-Server	<ul style="list-style-type: none"> • 6.1 • 6.5 • 7.0 • 7.1 • 7.2 • 7.5 • 8.0

If you currently use an unsupported release of Genesys Framework or T-Server, you must upgrade to a supported release before you install the IVR Server.

Note: Genesys Framework and Genesys T-Server can be installed on the same computer on which the IVR Server is installed, or a different one.

Configuration Changes

Table 93 shows the configuration option differences between the Network T-Server 6.5 for XML-Based GenSpec application and the IVR Server 7 application.

Table 93: NTS for XML-Based GenSpec and IVR Server Differences

NTS GenSpec Option Name	Type of Change	Details
GenSpec Section		
MaxCallLifetime	Delete	Option Call Timeout in the Timers section is used in place of MaxCallLifetime.
IRTimeout	Delete	Option Router Timeout in the Timers section is used in place of IRTimeout.
gli-keep-alive-interval	None	This option and its values remain the same in IVR Server.
gli-keep-alive-tries	None	This option and its values remain the same in IVR Server.
gli-reconnect-delay	None	This option and its values remain the same in IVR Server.
gli-link-proving-delay	None	This option and its values remain the same in IVR Server.
gli_server		
gli-server-mode	None	This option and its values remain the same in IVR Server.
gli-n-servers	None	This option and its values remain the same in IVR Server.
gli_server_group_<n>		
gli-circuit-failover	None	This option and its values remain the same in IVR Server.
gli-server-address	None	This option and its values remain the same in IVR Server.
gli-client-list	None	This option and its values remain the same in IVR Server.

Table 93: NTS for XML-Based GenSpec and IVR Server Differences (Continued)

NTS GenSpec Option Name	Type of Change	Details
pgf		
ptc-file	Change value	Valid value is any valid relative or absolute path to the I-Server .smx file.
CallIdSap		
output-network-call-id-key	Delete	This option does not exist in IVR Server.
input-network-call-id-key	Change value	Valid Value: XML.Message.GctiMsg.CallId.Val.
license		
license-file	None	The name of a valid license file is required for T-Server 7.x and IVR Server 7.
num-of-licenses	None	The starting number of licenses to be checked out for this IVR Server 7.
num-sdn-licenses	Change in usage for IVR Server	The number of seat DN licenses to be checked out for T-Server and for IVR Server when it is configured for IVR Network T-Server mode. Do not use this option for IVR Server unless you are using IVR Network T-Server mode.
IServer		
called-num-subset	New	Determines the number of rightmost digits of callNum that are to be used as AttributeThisDN in T-Library messages. Default value is 0. Valid value is any positive integer.
dtd-file	New	Specifies the name of the .dtd file to be included in XML messages sent by IVR Server.
IServerGLMSap		
checkout-interval	New	The interval at which IVR Server attempts to request license updates from FlexLM for the maximum call usage during that interval.
operation-mode	New	This option must be set to IVR or NTS for IVR Server 7 to run.

IVR XML Implementations

[Table 94](#) lists the kinds of implementations that can use the IVR XML protocol rather than the GenSpec XML protocol.

Table 94: Implementations Using GenSpec XML and IVR XML

Protocol	Implementations Used
GenSpec XML	<ul style="list-style-type: none"> • SCP, Service Node, Network, Parking IVR
IVR XML	<ul style="list-style-type: none"> • SCP, Service Node, Network, Parking IVR • IVR-In-Front • IVR-Behind the PABX

Message Specification Migration

This section provides information on migrating from the GenSpec XML 2.8 protocol to the IVR XML 1.05 protocol. It describes the minimum set of IVR XML messages and flows required to reach iso-functionality with GenSpec XML.

[Table 95](#) compares the message specifications for GenSpec XML and IVR XML and shows the required changes for protocol migration at the Transport and Communication layers.

Table 95: Transport and Communication Layer Modifications

Layer	GenSpec XML	IVR XML	Status
Communication Layer	TCP	TCP	No Change
Message	GLI (header) + XML Msg (Data)	GLI (Header) + XML Msg (Data)	No Change

Table 95: Transport and Communication Layer Modifications (Continued)

Layer	GenSpec XML	IVR XML	Status
XML Msg	GenSpec XML 2.8 NewCall RouteRequest RouteResponse Connected EndCall Failure RunApp AppStarted AppCompleted Cancel CancelCompleted	IVR XML LoginReq LoginResp flow on connection setup NewCall RouteRequest RouteResponse Connected EndCall Failure TreatCall TreatStatus TreatStatus Cancel CancelCompleted	Added: LoginRequest LoginResponse flow on connection setup Modified: The flows are identical, but some Msg names and Msg tags have changed. GenSpec XML is a subset of IVR XML.

Message Changes

The only required changes for the protocol migration from GenSpec XML to IVR XML are in the XML Messages. The following sections describe these changes. For a full understanding of the IVR XML protocol, refer to the relevant *Genesys Developer Program IVR SDK XML Developer's Guide*.

XML Header: Reference to DTD File

The reference to the DTD file in the XML Message header has changed. GenSpec XML used to refer to `GctiMsg.dtd`. IVR XML refers to `IServer.dtd`, which is provided and installed along with the I-Server application.

GenSpec XML

```
<?xml version="1.0" encoding="ISO-8859-1"?>
<!DOCTYPE GctiMsg PUBLIC "GctiMsgId" "GctiMsg.dtd">
or
<?xml version="1.0" encoding="ISO-8859-1"?>
<!DOCTYPE GctiMsg SYSTEM "GctiMsgId" "GctiMsg.dtd">
```

IVR XML

```
<?xml version='1.0' encoding='iso-8859-1'?><!DOCTYPE GctiMsg SYSTEM
'IServer.dtd'>
```

Encoding of Extensions and UserData

Encoding of Extensions and UserData has changed from GenSpec XML to IVR XML.

GenSpec XML

Extensions Tag:

```
<ExtnsEx>
```

UserData Tag:

```
<UDataEx>
```

Encoding of a Key Value Pair:

```
<NVPair>
  <NVName>Customer Number</NVName>
  <NVVal>162739</NVVal>
</NVPair>
```

Only Key Value Pairs of type String are supported.

Extensions example:

```
<ExtnsEx>
  <NVPair>
    <NVName>Customer Number</NVName>
    <NVVal>162739</NVVal>
  </NVPair>
</ExtnsEx>
```

UserData example:

```
<UDataEx>
  <NVPair>
    <NVName>Customer Number</NVName>
    <NVVal>162739</NVVal>
  </NVPair>
</UDataEx>
```

From GctiMsg.dtd:

```
<!ELEMENT UserData (NVPair)+>
<!ELEMENT Extensions (NVPair)+>
```

```

<!ELEMENT NVPair (NVName, NVVal)>
<!ELEMENT NVName (#PCDATA)>
<!ELEMENT NVVal (#PCDATA)>

```

IVR XML

Extensions Tag:

```
<ExtnsEx>
```

UserData Tag:

```
<UDataEx>
```

Encoding of a Key Value Pair:

```
<Node Name='Customer Number' Type='Str' Val='162739' />
```

Key Value Pairs of types String, Integer, and Binary are supported. Possible Node Types are Str, Int, and Bin.

Extensions example:

```

<ExtnsEx>
  <Node Name='Customer Number' Type='Str' Val='162739' />
</ExtnsEx>

```

UserData example:

```

<UDataEx>
  <Node Name='Customer Number' Type='Str' Val='162739' />
</UDataEx>

```

From IServer.dtd:

```

<!ELEMENT List (Node | List)+>
<!ATTLIST List Name CDATA #REQUIRED>
<!ELEMENT Node EMPTY>
<!ATTLIST Node Name CDATA #REQUIRED
  Type (Int | Str | Bin) #REQUIRED
  Val CDATA #REQUIRED>
<!ELEMENT UDataEx (Node | List)+>
<!ELEMENT ExtnsEx (Node | List)+>

```

Login Flow on Connection Setup

After establishing a connection to the IVR Server, the IVR needs to initiate a session and authenticate the user access to the IVR Server.

This is done by sending a Login Request (LoginReq) to the IVR Server. This message contains two attributes:

- `Version`, which identifies the version of the protocol (2.0 for IVR XML)
- `ClientName`, which corresponds to the name given to the IVR application object in Configuration Manager.

IVR Server will inform the IVR if the login was successful or not, through a Login Response (LoginResp).

This message contains at least two attributes:

- `IServerVer`, which identifies the version of the IVR Server
- `Result: Success | InvalidProtocolVer`

Call Routing Messages

NewCall Message

Apart from the encoding of Extensions and UserData, the shape of the NewCall message has not changed. GenSpec XML and IVR XML are still using the same attributes. The only difference is in the Version attribute, which is now a required parameter in IVR XML:

GenSpec XML

```
Version="1.0"
```

IVR XML

```
Version = "2.0"
```

RouteRequest Message

Apart from the encoding of Extensions and UserData, the shape of the RouteRequest message has not changed for IVR Network T-Server implementations. In IVR XML, the RouteRequest message has a new attribute RouteDN, which is required in IVR-In-Front and IVR-Behind-Switch implementations. This attribute contains the value of the DN where a strategy is loaded (value of a Routing Point configured on the Switch).

From IServer.dtd (IVR XML):

```
<!ELEMENT RouteRequest (CED?, ((UserData?, Extensions?)|(UDataEx?,
ExtnsEx?)))>
<!ATTLIST RouteRequest RouteDN CDATA #IMPLIED>
<!ELEMENT CED (#PCDATA)>
```

RouteResponse Message

Apart from the encoding of Extensions, the shape of the RouteResponse message has not changed. GenSpec XML and IVR XML are still using the same attributes.

Connected Message

Apart from the encoding of Extensions, the shape of the Connected message has not changed. GenSpec XML and IVR XML are still using the same attributes.

EndCall Message

Apart from the encoding of Extensions and UserData, the shape of the EndCall message has not changed. GenSpec XML and IVR XML are still using the same attributes.

The only change is at the Call Model level. With GenSpec XML and GenSpec XML T-Server, it was possible to trigger EndCall(EndCause = Resources), generating RequestRouteCall(RouteTypeReject) at Universal Routing Server level. With IVR XML and IVR Server, RequestRouteCall(RouteTypeReject) triggers EndCall(EndCause = Default) or EndCall(EndCause = Normal) if AttributeOtherDN is not empty.

Failure Message

Apart from the encoding of Extensions, the shape of the Failure message has not changed. GenSpec XML and IVR XML are still using the same attributes.

In GenSpec XML, the Failure message was used to report routing and treatment failures:

- FailureCause = Busy | NoAnswer | ConnectFailed for routing failures
- FailureCause = RunAppFailed for treatment failures.

In IVR XML, a new message has been introduced to specifically report treatment failures — TreatStatus(Status = NotStarted). Routing failures are still reported through the Failure message, using FailureCause = Busy | NoAnswer | ConnectFailed. Therefore, Failure(FailureCause = RunAppFailed) is not supported anymore by IVR XML and IVR Server.

Treatment Messages

Between GenSpec XML and IVR XML, most of the treatment messages have changed. These changes apply to Message names or Message attributes. The role of each message and the call flows remain unchanged.

RequestID attribute

In GenSpec XML, treatments used to be identified by a Request ID within each call context. This behavior does not apply to IVR XML. The RequestID attribute has been removed from all treatment messages.

Request for treatment

GenSpec XML only supported one type of Genesys treatment: Play Application. IVR XML has been enhanced to support all Genesys treatments.

In GenSpec XML, a request for treatment was triggered at the IVR level through the RunApp message. This message has been removed from IVR XML and has been replaced by a TreatCall message.

GenSpec XML

Exchange of parameters with the IVR was possible through the AppName attribute (mapped with Treatment Play Application - APP_ID) and the Extensions (mapped with Genesys AttributeExtensions).

Message Name: RunApp

```
<!ELEMENT RunApp (RequestId, AppName, Extensions?)>
<!ELEMENT RequestId (#PCDATA)>
<!ELEMENT AppName (#PCDATA)>
```

IVR XML

Exchange of parameters with the IVR is now possible through the Parameters attribute (mapped with Genesys AttributeTreatmentParms) and the Extensions (mapped with Genesys AttributeExtensions).

The TreatCall message also includes a Type attribute, which describes the kind of Genesys treatment and is requested from the strategy.

If a Treatment Play Application is requested from the strategy (required with GenSpec XML), then the Type attribute will be set to PlayApplication.

RequestID attribute is no longer present in the request for treatment.

Message Name: TreatCall

```
<!ELEMENT TreatCall (Parameters?, ExtnsEx?)>
<!ATTLIST TreatCall Type (PlayAnnounce |
  PlayAnnounceAndDigits |
  Music | RAN | Busy |
  CollectDigits| CancelCall|
  SetDefaultRoute|
  PlayApplication | IVR | RingBack |
  Silence | VerifyDigits | RecordAnnounce |
  DeleteAnnounce | TextToSpeech | FastBusy |
  TextToSpeechAndDigits) #REQUIRED>
<!ELEMENT Parameters (Node | List)+>
```

Recommended:

If the IVR only supports `Type = PlayApplication`, it is strongly recommended to have the IVR send a `TreatStatus (Status = NotStarted)` message if another treatment `Type` is received or requested.

Treatment Started notification

After receiving a request for treatment and starting its execution, the IVR needs to inform the Genesys applications that the treatment has successfully started.

In GenSpec XML, this notification was sent through the `AppStarted` message. This message has been removed from IVR XML and has been replaced by a `TreatStatus (Status = Started)` message.

GenSpec XML

The `AppStarted` message only contained a `RequestID` attribute, and its value had to map the one sent in the previous `RunApp` message.

Message Name: `AppStarted`
`<!ELEMENT AppStarted (RequestId)>`

IVR XML

The `TreatStatus` message has several purposes:

- Report that the treatment has successfully started.
- Report that the treatment could not be applied.
- Report that the treatment has been completed.

In order to report the fact that the treatment could be applied and has started successfully, the `Status` attribute must be set to `Started`.

The `TreatStatus` message also includes `Extensions` and `UserData` attributes. But when the `Status` attribute is set to `Started`, the IVR Server does not take these parameters into account. `Extensions` and `UserData` only apply when `Status` is set to `Completed`.

`RequestID` attribute is no longer present in the `Treatment Started` notification.

Message Name: `TreatStatus`

Required Attribute: `Status = Started`

```
<!ELEMENT TreatStatus (UDataEx?, ExtnsEx?)>
<!ATTLIST TreatStatus Status (Started | NotStarted | Completed)
#REQUIRED
CED CDATA #IMPLIED>
```

Treatment Failure notification

After receiving a request for treatment, if the IVR is not able to apply it due to a lack of resources or an unsupported treatment type, the IVR needs to inform the Genesys applications that the treatment could not be started and applied.

In GenSpec XML, this notification was sent through the `Failure` message, setting the `FailureCause` to `RunAppFailed`. This message has been removed from IVR XML and has been replaced by a `TreatStatus (Status = NotStarted)` message.

GenSpec XML

In GenSpec XML, the `Failure` message was used to report routing and treatment failures:

- `FailureCause = Busy | NoAnswer | ConnectFailed` for routing failures.
- `FailureCause = RunAppFailed` for treatment failures.

When a treatment could not be applied on the IVR, this was reported back to the Genesys applications through a `Failure (FailureCause = RunAppFailed)` message.

IVR XML

The `TreatStatus` message has several purposes:

- Report that the treatment has successfully started.
- Report that the treatment could not be applied.
- Report that the treatment has been completed.

In order to report the fact that the treatment could not be applied, the `Status` attribute must be set to `NotStarted`.

The `TreatStatus` message also includes `Extensions` and `UserData` attributes. But when the `Status` attribute is set to `NotStarted`, the IVR Server does not take these parameters into account. `Extensions` and `UserData` only apply when `Status` is set to `Completed`.

`RequestID` attribute is no longer present in the Treatment Failure notification.

Message Name: `TreatStatus`

Required Attribute: `Status = NotStarted`

```
<!ELEMENT TreatStatus (UDataEx?, ExtnsEx?)>
<!ATTLIST TreatStatus Status (Started | NotStarted | Completed)
#REQUIRED
CED CDATA #IMPLIED>
```

Treatment Completion notification

After applying a treatment and eventually collecting some data, the IVR needs to inform the Genesys applications that the treatment has successfully completed.

In GenSpec XML, this notification was sent through the `AppCompleted` message. This message has been removed from IVR XML and has been replaced by a `TreatStatus (Status = Completed)` message.

GenSpec XML

The `AppCompleted` message contained a `RequestID` attribute, and its value had to map the one sent in the previous `RunApp` message.

If provided, the value of `CED` attribute was mapped with `AttributeCollectedDigits` in the `EventTreatmentEnd` message.

Other data collected on the IVR could be sent to the Genesys applications through the `Extensions` or `UserData` attributes.

Message Name: `AppCompleted`

```
<!ELEMENT AppCompleted (RequestId, CED?, UserData?, Extensions?)>
<!ELEMENT CED (#PCDATA)>
```

IVR XML

The `TreatStatus` message has several purposes:

- Report that the treatment has successfully started.
- Report that the treatment could not be applied.
- Report that the treatment has been completed.

In order to report the fact that the treatment has completed successfully, the `Status` attribute must be set to `Completed`.

If provided, the value of the `CED` attribute is mapped with `AttributeCollectedDigits` in the `EventTreatmentEnd` message.

The `TreatStatus` message also includes `Extensions (ExtnsEx)` and `UserData (UDataEx)` attributes. When the `Status` attribute is set to `Completed`, the IVR Server takes these parameters into account, and presents them in `AttributeExtensions` and `AttributeUserData` of the `EventTreatmentEnd` message.

`RequestID` attribute is no longer present in the `Treatment Completed` notification.

Message Name: `TreatStatus`

Required Attribute: `Status = Completed`

```
<!ELEMENT TreatStatus (UDataEx?, ExtnsEx?)>
<!ATTLIST TreatStatus Status (Started | NotStarted | Completed)
#REQUIRED
CED CDATA #IMPLIED>
```

Request for Cancel

When a treatment is being applied on the IVR and a Routing Request is sent by Universal Routing Server to the T-Server (GenSpec XML T-Server or IVR Server), the T-Server first sends a Cancel message to the IVR.

The same message name is used with GenSpec XML and IVR XML.

GenSpec XML

The Cancel message only contained a RequestID attribute, and its value had to map the one sent in the previous RunApp message.

Message Name: Cancel

```
<!ELEMENT Cancel (RequestID)>
```

IVR XML

The Cancel message has no attribute.

RequestID attribute is no longer present in the request to cancel.

Message Name: Cancel

```
<!ELEMENT Cancel EMPTY>
```

Cancel Completion notification

When a treatment is being applied on the IVR and a Routing Request is sent by Universal Routing Server to the T-Server (GenSpec XML T-Server or IVR Server), the T-Server first sends a Cancel message to the IVR. Before the T-Server sends the RouteResponse message with the appropriate destination, the IVR has to notify the T-Server that the treatment was successfully completed. This could be done using a AppCompleted/TreatStatus(Status = Completed) message or using a CancelCompleted message.

In the case of a CancelCompleted notification, the same message name is used with GenSpec XML and IVR XML.

GenSpec XML

The CancelCompleted message only contained a RequestID attribute, and its value had to map the one sent in the previous RunApp message.

Message Name: CancelCompleted

```
<!ELEMENT CancelCompleted (RequestID)>
```

IVR XML

The CancelCompleted message has no attribute.

RequestID attribute is no longer present in the request to cancel.

Message Name: CancelCompleted

```
<!ELEMENT CancelCompleted EMPTY>
```

Treatment Play Application mapping

If a Treatment Play Application is requested from the strategy, the mapping between the Genesys attributes and the GenSpec XML/IVR XML attributes operates as presented below.

GenSpec XML

By default, the APP_ID attribute (in AttributeTreatmentParms) of the Treatment Play Application will be mapped with the AppName attribute of the RunApp message.

In the Genesys T-Library, APP_ID is encoded as an integer. Therefore, if digits or a string must be sent to the IVR in the AppName attribute, a workaround had been set in place at the GenSpec XML T-Server level.

If a parameter with a key equal to the value of the APP_ID parameter was present in the AttributeTreatmentParms, its value was used to fill the AppName attribute.

Example 1: T-Library request:

```
RequestApplyTreatment
AttributeThisDN'2001'
AttributeConnID009001017f2e0001
AttributeTreatmentTypeTreatmentPlayApplication
AttributeTreatmentParms[37] 00 02 01 00..
'APP_ID'1
'LANGUAGE' 'English'
AttributeReferenceID3
```

GenSpec XML message:

```
RunApp(AppName = "1")
```

Example 2: T-Library request:

```
RequestApplyTreatment
AttributeThisDN'2001'
AttributeConnID009001017f2e0001
AttributeTreatmentTypeTreatmentPlayApplication
AttributeTreatmentParms[37] 00 02 01 00..
'APP_ID'1
'LANGUAGE' 'English'
'1' 'Customer Number'
AttributeReferenceID3
```

GenSpec XML message:

```
RunApp(AppName = "Customer Number")
```

IVR XML

This workaround does not apply to IVR XML and IVR Server. Indeed, all treatment parameters can be sent to the IVR. Therefore, the T-Library requests will result in the messages presented below.

Example 1: T-Library request:

```

RequestApplyTreatment
  AttributeThisDN'2001'
  AttributeConnID009001017f2e0001
  AttributeTreatmentTypeTreatmentPlayApplication
  AttributeTreatmentParms[37] 00 02 01 00..
  'APP_ID'1
  'LANGUAGE' 'English'
  AttributeReferenceID3

```

GenSpec XML message:

```

<TreatCall Type='PlayApplication'>
  <Parameters>
    <Node Name='APP_ID' Type='Int' Val='1'/>
    <Node Name='LANGUAGE' Type='Str' Val='English'/>
  </Parameters>
</TreatCall>

```

Example 2: T-Library request:

```

RequestApplyTreatment
  AttributeThisDN'2001'
  AttributeConnID009001017f2e0001
  AttributeTreatmentTypeTreatmentPlayApplication
  AttributeTreatmentParms[37] 00 02 01 00..
  'APP_ID'1
  'LANGUAGE' 'English'
  '1' 'Customer Number'
  AttributeReferenceID3

```

GenSpec XML message:

```

<TreatCall Type='PlayApplication'>
  <Parameters>
    <Node Name='APP_ID' Type='Int' Val='1'/>
    <Node Name='LANGUAGE' Type='Str' Val='English'/>
    <Node Name='1' Type='Str' Val='Customer Number'/>
  </Parameters>
</TreatCall>

```



Part

9

Call Concentrator Migration

The chapters in this section describe the migration process from release 6.1 to release 7.0 of Call Concentrator. They also discuss the other Genesys software that supports and enables Call Concentrator 7.0 functionality.

The information is divided into the following chapters:

- Chapter 32, “Introduction to Call Concentrator Migration,” on page 549 discusses the preliminary migration procedures and the migration order for Call Concentrator.
- Chapter 33, “Changes in Call Concentrator 7.0,” on page 553 presents information that you need to upgrade the configuration options of Call Concentrator from release 6.1 to 7.0. This section only discusses changes (additions, deletions, and modifications) in the product that need specifically to be addressed during the migration process.
- Chapter 34, “Call Concentrator Migration Procedures,” on page 555 discusses the migration procedures for release 6.1 to 7.0.

Note: Call Concentrator did not have 6.0 or 6.5 releases.



Chapter

32

Introduction to Call Concentrator Migration

This chapter discusses the preliminary migration procedures and the migration order for Call Concentrator 7.0 and contains the following sections:

- [Preliminary Migration Procedures, page 549](#)
- [Migration Order 7.0, page 550](#)
- [Interoperability, page 551](#)

Preliminary Migration Procedures

Note: If you want to upgrade your operating system before migrating your Genesys product, contact Professional Services.

The migration process includes these preliminary procedures for Call Concentrator 7.0:

1. Review Chapter 1, “Migration Roadmap,” on [page 35](#) of this guide.
2. Examine the order in which the Genesys software required for Call Concentrator 7.0 should be upgraded. See “Migration Order 7.0” on [page 550](#).
3. Examine the option changes for Call Concentrator in “Changes to Call Concentrator Configuration Options” on [page 554](#).

Note: For complete information about new features and functionality in this release of Call Concentrator, see the *Call Concentrator 7 Getting Started Guide*. For a complete list of configuration options for Call Concentrator 7, see the *Call Concentrator 7 Deployment Guide*.

4. Review the licensing requirements for Call Concentrator 7.0. See Chapter 2, “Licensing Migration,” on [page 41](#).
5. See *Genesys 8 Interoperability Guide* for information on the compatibility of Genesys products with various Configuration Layer Environments; Interoperability of Reporting Templates and Solutions; and *Gplus Adapters Interoperability*.
6. Review other issues pertaining to the migration of Call Concentrator to version 7.0. See “Additional Information about Migration” on [page 552](#).

Reference Materials

- *Genesys Licensing Guide*
- *Call Concentrator 7 Getting Started Guide*
- *Call Concentrator 7 Deployment Guide*
- *Call Concentrator 7 Reference Manual*
- *Genesys 8 Interoperability Guide*

Migration Order 7.0

This section is specific to the applications and components that enable or support Call Concentrator.

Multi-Site/Single-Site and Multi-Tenant Migration

It is possible to migrate all sites or all tenants simultaneously or to migrate separate sites independently. Because the migration from Call Concentrator 6.1 to 7.0 does not require any modification of the database structure, you can have instances of Call Concentrator 6.1 and 7.0 operating simultaneously.

Migration and Upgrade Order

Note: The steps below are an outline of the stages of migration. For detailed step-by-step migration instructions, see Chapter 34, “Call Concentrator Migration Procedures,” on [page 555](#).

To Update or Migrate Call Concentrator

Migrate or upgrade the Call Concentrator 7.0 application, the other enabling software, and relevant data for Call Concentrator in the following order:

1. Install the updated License Manager, which is required for all Genesys 7 products, and obtain a Call Concentrator 7 license file.
See Chapter 2, “Licensing Migration,” on [page 41](#) in this guide and the *Genesys Licensing Guide*.

2. Migrate any Genesys products you are upgrading. Call Concentrator requires these Genesys products:
 - DB Server.
 - Configuration Server.
 - T-Server(s).
 - Load Distribution Server (optional).

Note: Call Concentrator 7 is backward compatible with a Genesys 6.5 or 6.1 environment.

3. If necessary, update your contact center configuration (e.g., Place Groups, Agent Groups, DNs, and so on) using Configuration Manager.
4. Configure any upgraded or new T-Server(s), DBServer and Database Access Point(s) before proceeding to create and configure the Call Concentrator application.
5. Back up your Call Concentrator database.
6. Follow the normal installation and configuration procedures, as explained in the *Call Concentrator 7 Deployment Guide*.

Interoperability

The term *interoperable* means that different versions of Genesys solutions, components, or options can work together compatibly.

Interoperability of Genesys products can occur at two levels:

- **Interoperability at the suite-level** means combining different versions of solutions and options.

Example: You can migrate to the Configuration Management Layer of Framework 7.0 while still using 6.5 components. See the *Genesys 7 Interoperability Guide* and the *Genesys 8 Interoperability Guide* for information on the compatibility of Genesys products with various Configuration Layer Environments; Interoperability of Reporting Templates and Solutions; and *Gplus* Adapters Interoperability.

- **Interoperability at the solution-specific level** means combining different versions of the components of a particular solution.

Compatibility Among Components of Call Concentrator

Call Concentrator 7.0 includes only Call Concentrator itself. It has no other components.

Additional Information about Migration

For a high-level overview of migration issues, please see Chapter 1, “Migration Roadmap,” on [page 35](#) in this guide.



Chapter

33

Changes in Call Concentrator 7.0

This section provides information to upgrade the configuration options of Call Concentrator from release 6.1 to 7.0. This section discusses changes (additions, deletions, and modifications) to be made during the migration process. The product documentation for each release contains a comprehensive list of changes from release to release:

- *Reporting 6.1 Overview for Call Concentrator*
- *Call Concentrator 7 Getting Started Guide*

This chapter discusses the following topics:

- [Changes for 7.0, page 553](#)
- [Changes to Call Concentrator Configuration Options, page 554](#)

Changes for 7.0

Call Concentrator 7 includes no new database features that affect migration. Call Concentrator calculations of `WtTime`, `RoutTime`, and `RingTime` have been modified. These changes do not affect migration.

Note: For information about all the new features and functions in Call Concentrator 7.0, including a detailed explanation of the changes to `WtTime`, `RoutTime`, and `RingTime`, see Chapter 2, “Introducing Call Concentrator 7,” in the *Call Concentrator 7 Getting Started Guide*.

Changes to Call Concentrator Configuration Options

Table 96 explains the changes to the Call Concentrator application options.

Table 96: Configuration Option Changes from 6.1 to 7.0

Option/Section Name	Type of Change	Change Occurred in Version #	Details
logfile Options Section	Section removed	6.1	Logging is handled through the Genesys common logging system. Use the Log options section to set logging parameters.
Configuration Options Section			
	<i>AgentStatuses</i> option added	6.1.300.01	
	<i>DbMaxErrors BeforeShutdown</i> option added	6.1.200.00	
	<i>IgnoreRingingTime</i> option added	6.1.200.00	
	<i>use_original_connid</i> option added	6.1.200.00	
	<i>StatInterval</i> option added	6.1.200.04	
	<i>UseCfgDNType</i> option added	6.1.300.08	
	<i>IgnoreVRP</i> option added	6.1.300.08	
	<i>show-attached-data</i> option added	7.0	



Chapter

34

Call Concentrator Migration Procedures

This chapter discusses the migration procedures for release 6.1 to 7.0 and contains this section:

- [Migration from 6.1 to 7.0, page 555](#)

Note: Call Concentrator had no 6.5 release.

Migration from 6.1 to 7.0

This chapter discusses the migration procedures for Call Concentrator and other Genesys software that enables and supports it.

Preliminary Migration Procedures

Complete these preliminary procedures before starting your migration of Call Concentrator:

1. Install the updated License Manager, available in the Call Concentrator installation package.

Licensing is addressed in these documents:

- *Genesys Licensing Guide*
 - *Chapter 2, “Licensing Migration,” on [page 41](#)*
2. If desired, migrate Framework from 6.x to 7.0.
See “Interoperability” on [page 551](#).
 3. Upgrade of other prerequisite Genesys components, such as T-Server(s), if desired.

Migration Procedures

Follow these migration procedures:

To Migrate Call Concentrator

1. Update your contact center configuration as needed.
2. Configure any new T-Server(s), DB Server, and Database Access Point(s) or make any necessary changes to your existing ones.
3. Back up your Call Concentrator database.
4. Follow the Call Concentrator configuration and installation procedure for your platform, as described in the *Call Concentrator 7 Deployment Guide*.

Note: Consult Professional Services regarding migration of any and all customized Genesys products.

Rollback Procedures

To Rollback to Previous Version

If the upgrade of Call Concentrator fails, please proceed with the rollback procedure.

1. If you started Call Concentrator, stop it. For startup and shutdown methods, see Chapter 6, “Starting and Stopping,” in the *Call Concentrator 7 Deployment Guide*.
2. Follow the appropriate uninstall instructions for your platform in Chapter 7, “Uninstalling Call Concentrator,” in the *Call Concentrator 7 Deployment Guide*.



Part

10

Universal Routing Migration

Note: The term “Universal Routing” encompasses both Enterprise Routing and Network Routing.

The chapters in this section describe the migration process to Universal Routing 7.6 from release 7.2. They also discuss component changes and the other Genesys software that supports and enables Universal Routing 7.6 functionality.

The information is divided into the following chapters:

- Chapter 35, “Introduction to Universal Routing Migration,” on page 559 discusses the preliminary migration procedures and the migration order for Universal Routing 7.6.
- Chapter 36, “Changes in Universal Routing Through 7.6,” on page 591 provides information about changes in components, configuration options, functions, objects, and statistics used in Universal Routing from release 6.5 to 7.6.
- Chapter 37, “Universal Routing Migration Procedures,” on page 615 explains the migration procedures for releases 6.x to 7.6.

Note: 5.1/6.0/6.1 Customers: There is no direct migration from 5.x, 6.0, or 6.1 to 7.6. Instead, you must first migrate to 6.5 as described in the *Genesys 6.5 Migration Guide*, which can be found on the 6.5 Documentation Library DVD or the Technical Support website. Once the migration to 6.5 is complete, you can migrate directly to Universal Routing 7.6.

Migrating to Universal Routing 7.6 enables you to take full advantage of its new features and expanded capabilities. For detailed descriptions, see the following documents:

- *Universal Routing 7.6 Deployment Guide* (see the “New Features” section in the “Overview” chapter).
- *Universal Routing 7.6 Reference Manual*, for more detailed descriptions of the new objects, options, functions, and statistics mentioned in the New Features section of the *Deployment Guide*.
- *Universal Routing 7.6 Routing Solutions Guide*, for information on skills-based routing, business priority routing, cost-based routing, and share agent by service level agreement routing.
- *Genesys 7.5 Proactive Routing Solution Guide*, for information on a solution that results from the integration of Universal Routing, Outbound Contact, Multimedia, and Agent Desktop.
- *Universal Routing 7.6 Interaction Routing Designer Help*
- *Universal Routing Server 7.6.x Release Note*
- *Interaction Routing Designer 7.6.x Release Note*
- *Custom Server 7.6.x Release Note*
- In addition, the new features and expanded capabilities are summarized in Chapter 37, “Universal Routing Migration Procedures,” on [page 615](#) of this guide.



Chapter

35

Introduction to Universal Routing Migration

This chapter discusses the preliminary migration procedures and component compatibility for Universal Routing 7.6. It contains the following sections:

- [Preliminary Migration Procedures, page 559](#)
- [Order of Migration for Universal Routing, page 561](#)
- [Interoperability Among Universal Routing Components, page 563](#)
- [Availability of New Features and Capabilities, page 566](#)

Preliminary Migration Procedures

Follow these procedures before migrating to Universal Routing 7.6.

Database/Operating System Upgrade

Before migration, you may need to upgrade the operating system and/or database used by Universal Routing 7.6. Determine whether you need to upgrade by checking the *Genesys Supported Operating Environment Reference Manual*.

Note: If you need to upgrade your operating system or database, you must do this before migrating your Genesys product.

If you need to upgrade your operating system and/or database, consult your vendor documentation.

Preliminary Genesys Migration Procedures

The Genesys migration process includes these preliminary procedures for Universal Routing 7.6:

1. Review “Migration Roadmap” on [page 35](#) of this guide.
2. Examine the order in which the Genesys software required for Universal Routing 7.6 should be upgraded. See “Order of Migration for Universal Routing” on [page 561](#).
3. Examine the component changes in “Component Changes for Universal Routing” on [page 592](#).

You might also want to review:

- “Configuration Option Changes” on [page 593](#).
- “Changes to Functions” on [page 600](#).
- “Changes to Strategy-Building Objects” on [page 608](#)
- “Changes to Predefined Statistics” on [page 611](#)

Note: Please note that these tables only discuss changes that directly affect migration of this product. For more high-level information about what’s new in Universal Routing 7.6, see the “New Features” section in the “Overview” chapter of the *Universal Routing 7.6 Deployment Guide*. For a complete list of documentation relevant to the migration of this product, see “Reference Materials” on [page 561](#).

4. Review the licensing requirements for Universal Routing 7.6. See Chapter 35, “Introduction to Universal Routing Migration,” on [page 559](#). Key points are summarized below:
 - You must set up licensing before starting to install and configure Universal Routing 7.6, which works with FLEXlm 8.3. or 9.5. However, if your operating system is Red Hat Enterprise Linux AS v4.0 or 3.0 on the 32-bit Intel platform, you must install FLEXlm 9.5 (there is no FLEXlm 8.3 for Linux).
 - For Release 7.6, Genesys implements its Interim Licensing Solution (ILS). The term “Interim” means prior to Genesys Release 8.0. The intent of the ILS is to simplify and streamline the current licensing system. The main element of the ILS is a Default license control file based solely on the number of Enterprise Routing and Network Routing seats—whether single-site, multi-site, or as part of the CIM platform.
 - Genesys will not proactively retrieve and replace all existing license files in production. First-time purchases and upgrade requests will be fulfilled using the Default license file (unless an exception has been requested).

- URS reports a license violation when it detects that the number of purchased seats exceeds the number allowed by the license, but doesn't stop normal operation. Instead, it will not route to the license-violated seats.
 - For more information on the ILS, consult the *Genesys Licensing Guide* document available on the Technical Support website and the Documentation Library DVD.
5. Check the interoperability of the Universal Routing components so that your components remain compatible during the migration process. See “Interoperability Among Universal Routing Components” on [page 563](#).
 6. See *Genesys 8 Interoperability Guide* for information on the compatibility of Genesys products with various Configuration Layer Environments; Interoperability of Reporting Templates and Solutions; and *Gplus* Adapters Interoperability.
 7. Review other issues pertaining to the migration of Universal Routing to version 7.6. See [Chapter 36](#).

Reference Materials

- *Genesys Licensing Guide*
- *Universal Routing 7.6 Deployment Guide* (contains both getting-started and deployment information).
- *Universal Routing 7.6 Reference Manual*
- *Universal Routing 7.6 Routing Application Configuration Guide*
- *Universal Routing 7.6 Cost-Based Routing Configuration Guide*
- *Genesys 7.6 Proactive Routing Solution Guide*
- *Genesys 8 Interoperability Guide*

Order of Migration for Universal Routing

The “Order of Migration” section in this chapter is specific to Universal Routing 7.6.

Single Site, Multi-Site and Multi-Tenant Migration

You can migrate all sites or all tenants simultaneously or migrate separate sites independently. If you will have different versions at different sites at any point during your migration, review the component interoperability restrictions discussed on [page 563](#).

Partial Upgrades

The basic process for multi-site customers involves stopping routing activity at a site and re-routing all interactions to another site during migration.

To minimize the amount of time taken by the re-routing process, you can do a partial migration and migrate only certain components during the re-route period.

Note: Universal Routing Server (URS) and Interaction Routing Designer (IRD) must be from the same release in order to work together. For example, you cannot run IRD 7.5 with URS 7.2; you cannot run IRD 7.5 with URS 7.6.

Migration and Upgrade Order

This section provides an overview of the migration order and procedures. Detailed instructions are available in [Chapter 37](#).

Migrate the components of Universal Routing 7.6, any other required software, and your data in the following order:

1. Install or upgrade Licensing Server. For details and the versions of Licence Manager supported, see Chapter 2, “Licensing Migration,” on [page 41](#) and *Genesys Licensing Guide*.
2. Migrate Management Framework, which is the foundation for all Genesys products, solutions, and options.
 - For information about migrating the layers and components of Management Framework, see “Framework Migration” in this guide.
3. Use the instructions found in [Chapter 37](#) to migrate Universal Routing components.

When upgrading components, determine whether each component you upgrade to version 7.6 is backward-compatible with the existing components. See “Interoperability Among Universal Routing Components” on [page 563](#).

4. Perform this step only if you are currently running 5.x strategies. You must recreate your 5.x strategies in IRD 7.6. IRD 7.2 and later does not recognize a 5.x strategy so you cannot load it on a routing point.

One way to handle this situation is to do as follows:

- Use the Migration Procedure information on chapter to install URS and IRD 7.6 in an environment separate from your Production environment.
- Export the URS options from your Production environment to the this separate environment.
- Document the objects, logic, and flow of each 5.x strategy on paper.
- Recreate each strategy in IRD 7.6.

- After the Universal Routing components are migrated to 7.6, export the recreated strategies to your Production environment.

Interoperability Among Universal Routing Components

The term *interoperable* refers to whether it is possible for different versions of Genesys solutions, components, or options to work together compatibly during the migration process.

- *Interoperability at the suite-level* means combining various versions of Genesys products during the migration process.

For example, you can install and use URS and IRD 7.6 with Genesys Framework 7.1. See the *Genesys 7 Interoperability Guide* and the *Genesys 8 Interoperability Guide* for information on the compatibility of Genesys products with various Configuration Layer Environments; Interoperability of Reporting Templates and Solutions; and *Gplus* Adapters Interoperability.

- *Interoperability at the product level* means combining different versions of the components of a particular product—such as Universal Routing—while migrating them sequentially.

Interoperability of Universal Routing components can occur with these restrictions: In order to obtain the fully functionality of a given release of Universal Routing, the same versions of URS and IRD must be installed and run together. In other words:

URS and IRD 7.6 must be installed and run together.

URS and IRD 7.5 must be installed and run together.

URS and IRD 7.2 must be installed and run together.

For example, you cannot migrate to URS 7.6 and use a 7.5 version IRD or vice-versa if you want the full functionality of Universal Routing 7.6.

Other examples:

Assume you are satisfied with the functionality of your current URS, but want to upgrade to the latest version of IRD. If you upgrade IRD, then you must upgrade URS. If you do not do this, the older version of URS will not know how to execute any new IRD objects, for example.

In the reverse case, assume you wish to upgrade URS, but are satisfied with the older version of IRD. In this case, it is possible not to upgrade IRD. However, as a result, not all functionality of the upgraded URS will be available to you.

Note that URS 7.6 can open/execute strategies created with versions of IRD previous to 7.6 as described in Table 105 on [page 588](#).

The following section provides detailed interoperability information.

Universal Routing Component Compatibility

A Genesys 7.6 routing solution is designed to work with the components in [Table 97](#):

Table 97: 7.6 Routing Solution Components

Component	Version	Notes
Universal Routing Server	7.6	<p>When the agent reservation feature is used in an LDS/multi-URS environment, Genesys recommends that all URSs come from the same family (all 7.5 or all 7.6, for example), and that you configure them all with the same set of options.</p> <p>Note: You can gracefully eliminate one URS instance at a time from traffic by setting its load percentage share to zero. New URSs can be added on the fly. However, when different families of URSs work together, agent reservation can sometimes be disrupted. Some URSs may get more successful reservations than others. While this will most likely not happen, it is possible.</p>
Interaction Routing Designer	7.6	
Custom Server	7.0. and later	Optional component.
Load Distribution Server	7.0 and later	Optional component. See Universal Routing Server note.
Universal Callback Server	7.0 and later	Optional component.

A Genesys 7.5 routing solution is designed to work with the components in [Table 98](#):

Table 98: 7.5 Routing Solution Components

Component	Version	Notes
Universal Routing Server	7.5	When the agent reservation feature is used in an LDS/multi-URS environment, Genesys recommends that all URSs come from the same family (all 7.5 or all 7.6, for example), and that you configure them all with the same set of options.
Interaction Routing Designer	7.5	
Custom Server	7.0. and later	Optional component.
Load Distribution Server	7.0 and later	Optional component. See Universal Routing Server note.
Universal Callback Server	7.0 and later	Optional component.

A Genesys 7.2 routing solution is designed to work with the components in [Table 99](#):

Table 99: 7.2 Routing Solution Components

Component	Version	Notes
Universal Routing Server	7.2	When the agent reservation feature is used in an LDS/multi-URS environment, Genesys recommends that all URSs come from the same family (all 7.2 or all 7.5, for example), and that you configure them all with the same set of options.
Interaction Routing Designer	7.2	
Custom Server	7.0. and later	Optional component.

Table 99: 7.2 Routing Solution Components (Continued)

Component	Version	Notes
Load Distribution Server	7.0 and later	Optional component. See Universal Routing Server note.
Universal Callback Server	7.0 and later	Optional component.

Note: URS/IRD 7.2 and later will work with Custom Server 6.0. However, this release of Custom Server is not Management Layer-compliant.

Availability of New Features and Capabilities

Each new Universal Routing 7.x release contains new features and enhanced capabilities, which are summarized below. These are fully described in the “New Features” section of the “Overview” chapter in the applicable *Universal Routing Deployment Guide*.

They are also described in the Universal Routing Server 7.x and Interaction Routing Designer 7.x Release Notes.

7.6 Feature and Component Matrix

[Table 100](#) shows what other Genesys software components (in addition to URS/IRD 7.6) are required to use the new features and capabilities in Universal Routing 7.6, which can work in a pure voice environment or with Genesys Multimedia components.

Note: Also see changes to options in [Table 109 on page 593](#), changes to functions in [Table 110 on page 600](#), changes to strategy-building objects in [Table 111 on page 609](#), and changes to predefined statistics in [Table 112 on page 612](#).

Table 100: 7.6 Feature and Component Matrix

Feature	Multimed. 7.5 or 7.6 Compon. required?	Stat Server version required	Custom Server version required	LDS version required	Config Server version required	T-Server version required
Universal Routing Server						
<p>Universal Routing 7.6 supports instant messaging using SIP Server. If an agent can receive both voice and IM interactions based on agent capacity rules, Universal Routing supports the following capabilities:</p> <p>Routing voice call to agents behind a traditional PBX (TDM phone and SIP Instant Messaging client).</p> <p>Routing voice calls to agents with SIP voice-only phones.</p> <p>Routing voice calls to agents with SIP endpoints supporting both the voice and the instant message channels at the same time.</p> <p>A single agent can support several instant message interactions simultaneously based on agent capacity rules.</p> <p>For more information on a Genesys Instant Messaging solution, see the <i>Genesys 7.6 Instant Messaging Solution Guide</i>.</p>	No	7.2 or later	6.5 or later	6.5 or later	7.2 or later	SIP Server 7.6 or later
<p>Enhanced prioritization mechanism used to select T-Servers for distributing virtual queue events. URS now takes into account the very first T-Server that the call was transferred from (if any).</p> <p>For more information, see the New Features section in the Overview Chapter of the <i>Universal Routing 7.6 Deployment Guide</i>.</p>	No	7.2 or later	6.5 or later	6.5 or later	7.2 or later	7.5 or later

Table 100: 7.6 Feature and Component Matrix (Continued)

Feature	Multimed. 7.5 or 7.6 Compon. required?	Stat Server version required	Custom Server version required	LDS version required	Config Server version required	T-Server version required
Enhanced method for updating a call's Caller-Entered Digits (CED) attribute. If <code>AttributeCollectedDigits</code> in the event has a value, URS updates CED upon receiving any event from the following list: <ul style="list-style-type: none"> • <code>EventQueued</code>, <code>EventRouteRequest</code>, <code>EventRinging</code>, <code>EventEstablished</code>, <code>EventPartyChanged</code> • Upon receiving <code>EventDigitsCollected</code> • Upon receiving <code>EventTreatmentEnd</code> for currently played treatment. 	No	7.2 or later	6.5 or later	6.5 or later	7.2 or later	7.5 or later
When option <code>hide-private_data</code> is set to true, in addition to its previous functionality: <ul style="list-style-type: none"> • URS will not print in its logs parameters for Web Service requests and also any result that a Web Service returns. • <code>http_bridge</code> will not print in its log parameters and results of Web Service requests. • <code>http_bridge</code> will not generate an <code>xml-soap</code> log. 	No	7.2 or later	6.5 or later	6.5 or later	7.2 or later	7.5 or later
IVR Server load balancing deployed in In-Front mode	No	7.2 or later	6.5 or later	6.5 or later	7.2 or later	7.5 or later
Option <code>report_reasons</code> enables you to add information to interactions regarding the reason for routing for reporting purposes (such as default routing performed by the switch).	No	7.2 or later	6.5 or later	6.5 or later	7.2 or later	6.5 or later

Table 100: 7.6 Feature and Component Matrix (Continued)

Feature	Multimed. 7.5 or 7.6 Compon. required?	Stat Server version required	Custom Server version required	LDS version required	Config Server version required	T-Server version required
Router Self-Awareness mode enables URSs deployed in a load sharing mode to communicate with each other regarding selected targets and target statistics. Options using and lds, set in Message Server, facilitate communications.	No	7.2 or later	6.5 or later	6.5 or later	7.2 or later	6.5 or later
When load balancing calls across multiple sites, you can use load balancing statistics to more accurately account for the number of calls at each site by including calls that in are transition from the network to the contact center site. For more information, see Table 112 on page 612 . Note: Some load balancing statistics take Router Self-Awareness into account but don't require it. Other load balancing statistics don't use Router Self-Awareness at all.	No	7.6	6.5 or later	6.5 or later	7.2 or later	6.5 or later
To support reporting on load balancing, and to allow for both real-time and historical reporting of calls in transition, you can set option report_statistics to instruct URS to attach additional reporting data to calls.	No	7.2 or later	6.5 or later	6.5 or later	7.2 or later	6.5 or later
You can implement a load balancing algorithm in your strategies using function StrTargets. It facilitates the creation of a comma-separated list of targets for use as input parameters to the utility subroutines described below.	No	7.2 or later	6.5 or later	6.5 or later	7.2 or later	6.5 or later

Table 100: 7.6 Feature and Component Matrix (Continued)

Feature	Multimed. 7.5 or 7.6 Compon. required?	Stat Server version required	Custom Server version required	LDS version required	Config Server version required	T-Server version required
Utility subroutines accept a comma-separated list of targets and a corresponding “selecting” procedure and then returns the optimal target.	No	7.2 or later	6.5 or later	6.5 or later	7.2 or later	6.5 or later
The RStatCallsInTransition statistic can be used in a strategy to adjust other statistics received from Stat Server. Returns the number of calls that URS believes are on the way to corresponding targets, but which have not yet arrived.	No	7.2 or later	6.5 or later	6.5 or later	7.2 or later	6.5 or later
The ExtrouterError function changes the default URS reaction upon failure to get a remote access number. If set to false, URS will continue the attempt to route the call based on the original number.	No	7.2 or later	6.5 or later	6.5 or later	7.2 or later	6.5 or later
The CountSkillInGroup function now uses the default Stat Server if the Stat Server parameter is missed in the function specification	No	7.2 or later	6.5 or later	6.5 or later	7.2 or later	6.5 or later
The ExcludeAgents function now actually excludes the agent if the agent was selected as a target and then excluded from the list of valid targets using the ExcludeAgents function.	No	7.2 or later	6.5 or later	6.5 or later	7.2 or later	6.5 or later
The StatExpectedWaitingTime statistic in the formula for the InVQWaitTime function is replaced with $\max(\text{StatLoadBalance}, 0) \cdot \text{StatLoadBalance}$ more accurately counts time to wait.	No	7.2 or later	6.5 or later	6.5 or later	7.2 or later	6.5 or later

Table 100: 7.6 Feature and Component Matrix (Continued)

Feature	Multimed. 7.5 or 7.6 Compon. required?	Stat Server version required	Custom Server version required	LDS version required	Config Server version required	T-Server version required
If T-Server distributes the EventDiverted message with state 22, URS updates AttributeExtensions of the EventDiverted message with a new key-value pair with key Reason and an integer value.	No	7.2 or later	6.5 or later	6.5 or later	7.2 or later	6.5 or later
As a result of receiving EventRouteUsed, EventReleased, or EventAbandoned, URS will provide the ReasonSystemName attribute specified by Interaction Server. It can then be forwarded to the reporting engine to report on the reason why the call left the virtual queue.	7.6	7.2 or later	6.5 or later	6.5 or later	7.2 or later	6.5 or later
You can secure the client-side port of the URS connection to Configuration Server during wizard installation. For other servers, use the Application object (Connections list).	For component support of client-side port security, see Table 101 on page 576 .					
Interaction Routing Designer						
Function FirstHomeLocation, returns the value of the FirstTransferHomeLocation field in the T-Server event that started the strategy. Function SetHomeLocation, allows you to specify the home location for the current call in a strategy. You can use these functions to implement the new prioritization mechanism to select a T-Server for Virtual Queue events distribution (see page 567 .)	No	7.2 or later	6.5 or later	6.5 or later	7.2 or later	7.2 or later

Table 100: 7.6 Feature and Component Matrix (Continued)

Feature	Multimed. 7.5 or 7.6 Compon. required?	Stat Server version required	Custom Server version required	LDS version required	Config Server version required	T-Server version required
<p>The View object used in business processes has the following new features:</p> <ul style="list-style-type: none"> • A new Scheduling tab lets you specify the scheduling conditions that Interaction Server should use, based upon the scheduled time contained in interactions. • A new Database Hints tab, especially applicable to an Oracle database, allows entry of special tags in SQL queries that cause queries to execute in a way that optimizes performance. • A new Segmentation tab can be used to submit an equal number of different interaction types (segments) and to limit the total number of interactions submitted to a strategy. • The General tab adds a Check Interval field where you can specify how often Interaction Server should check the queue associated with the view and, if necessary, adjust the number of interactions that can be submitted to the strategy. 	Yes	7.2 or later	6.5 or later	6.5 or later	7.6 or later	6.5 or later
<p>The Workbin object in IRD's Interaction Design window adds a Queue tab, which can be used for escalating interactions. The new tab allows you to associate the workbin with a private (invisible) queue or you can select an existing queue in the current business process.</p>	Yes	7.2 or later	6.5 or later	6.5 or later	7.6 or later	6.5 or later

Table 100: 7.6 Feature and Component Matrix (Continued)

Feature	Multimed. 7.5 or 7.6 Compon. required?	Stat Server version required	Custom Server version required	LDS version required	Config Server version required	T-Server version required
IRD's Function object contains several new Date and Time functions that you can use when setting the scheduled time in interactions: GetUTC, UTCAdd, UTCFromString, and UTCToString.	Yes	7.2 or later	6.5 or later	6.5 or later	7.2 or later	6.5 or later
When two or more URS instances run in load sharing mode through Load Distribution Server, IRD synchronizes strategy loading so you do not have to load/unload the same strategy on every URS for each Routing Point in IRD's Monitoring view.	No	7.2 or later	6.5 or later	6.5 or later	7.2 or later	6.5 or later
IRD can lock a strategy or subroutine to warn others that it is in use.	No	7.2 or later	6.5 or later	6.5 or later	7.2 or later	6.5 or later
The IRD installation process enables you to configure one or more security banner messages, which can be configured to display every time users log into IRD or on a one-time basis.	No	7.2 or later	6.5 or later	6.5 or later	7.2 or later	6.5 or later
When business processes are imported, strategies containing objects that use Screening Rules and Standard Responses now successfully recompile.	No	7.2 or later	6.5 or later	6.5 or later	7.2 or later	6.5 or later
Move variable definitions used in one strategy to another strategy.	No	7.2 or later	6.5 or later	6.5 or later	7.2 or later	6.5 or later
Export Solution and Import Solution views, menu commands, and logs help you avoid issues that may arise when migrating to different environments or when there are software versions.	No	7.2 or later	6.5 or later	6.5 or later	7.2 or later	6.5 or later

Table 100: 7.6 Feature and Component Matrix (Continued)

Feature	Multimed. 7.5 or 7.6 Compon. required?	Stat Server version required	Custom Server version required	LDS version required	Config Server version required	T-Server version required
You can export strategies and subroutines in archive (*.zcf), native (*.rbn), open (*.xml), and text (*.kvl) format. All other objects are exported in text (*.kvl) format.	No	7.2 or later	6.5 or later	6.5 or later	7.2 or later	6.5 or later
The properties of any strategy object can be exported to/imported from a text file through context menu commands Export object and Import object. Before inserting an imported object in another strategy, you can edit the object properties.						
You can now view a loaded strategy without first having to unload it	No	7.2 or later	6.5 or later	6.5 or later	7.2 or later	6.5 or later
The properties of any strategy object can be viewed/edited as plain text. This feature is useful when if there is a problem opening an object property dialog box.	No	7.2 or later	6.5 or later	6.5 or later	7.2 or later	6.5 or later
The Web Service object property dialog box allows you to provide parameters that can be used to authenticate (if necessary) Web Service requests during URS communication with the specified Web Service.	No	7.2 or later	6.5 or later	6.5 or later	7.2 or later	6.5 or later

Table 100: 7.6 Feature and Component Matrix (Continued)

Feature	Multimed. 7.5 or 7.6 Compon. required?	Stat Server version required	Custom Server version required	LDS version required	Config Server version required	T-Server version required
The MultiScreen and Screen objects now use screening rule display names instead of object names. This assists in name resolution when business processes containing routing strategies that use these objects are exported and imported back to different environments. The MultiScreen object gives the option of getting screening data from a variable.	Yes	7.2 or later	6.5 or later	6.5 or later	7.2 or later	6.5 or later
The Acknowledgement, Autoresponse, Chat Transcript, CreateEmailOut, CreateNotification, Create SMS, and Forward objects now use Standard Response display names instead of object names. This assists in name resolution when business processes containing routing strategies that use these objects are exported and imported back to different environments.	Yes	7.2 or later	6.5 or later	6.5 or later	7.2 or later	6.5 or later
The inactivity-timeout option allows you to require that users log back into IRD after a specified period of user inactivity.	No	7.2 or later	6.5 or later	6.5 or later	7.2 or later	6.5 or later
IRD implements Application level security. In order to use IRD 7.6, each Person object must have one or more Access Groups assigned. Any user without an assigned Access Group can open IRD, but can only view the GUI.	No	7.2 or later	6.5 or later	6.5 or later	7.2 or later	6.5 or later

Table 100: 7.6 Feature and Component Matrix (Continued)

Feature	Multimed. 7.5 or 7.6 Compon. required?	Stat Server version required	Custom Server version required	LDS version required	Config Server version required	T-Server version required
When creating subroutines, the Input Parameters dialog box allows you to specify the nature of all input parameters.	No	7.2 or later	6.5 or later	6.5 or later	7.2 or later	6.5 or later
Custom Server						
You can secure the client-side port of the Custom Server connection to Configuration Server. For other servers, use the Application object (Connections list).	For component support of client-side port security, see Table 101 .					

Client-Side Port Definition

[Table 101](#) indicates where client-side port configuration is supported for other servers.

Table 101: Solution Component Support for Client-Side Port Security

7.6 Clients	Config. Server/Config. Server Proxy	Custom Server	T-Server	URS
URS	Yes, 7.6 required	Yes, 7.6 required	Yes, 7.6 required	--
Custom Server	Yes, 7.6 required	--	NA	NA

Notes: NA = Not Applicable.

Client-side port configuration is not supported for DB Server, Load Distribution Server, Interaction Server, Message Server, and Stat Server.

For detailed information on client-side port configuration, see the “Client-Side Port Definition” chapter of the *Genesys 7.6 Security Deployment Guide*.

7.5 Feature and Component Matrix

[Table 102](#) shows what components are required to use the new features and capabilities in Universal Routing 7.5, which can work in a pure voice environment or with Genesys Multimedia components.

Table 102: 7.5 Feature and Component Matrix

Feature	Multimed.7.5 or 7.6 Compon. required?	URS/IRD version required	Stat Server version required	Custom Server version required	LDS version required	Config Server version required	T-Server version required
Universal Routing Server							
Cost-based routing. URS can calculate the Infrastructure and/or Resource cost of routing to any target and use the cost as additional target selection criteria. For more information, see the <i>Universal Routing 7.6 Cost-Based Routing Configuration Guide</i> .	No. Support only for voice and voip interaction.	URS/IRD 7.5 or later	6.5 or later	6.5 or later	6.5 or later	7.5	6.5 or later
Share agent by service level agreement routing. Allows you to perform conditional routing without the need to configure “looping” in complex strategies. For more information, see the <i>Universal Routing 7.6 Application Configuration Guide</i> .	No	URS/IRD 7.5 or later	6.5 or later	6.5 or later	6.5 or later	7.0.1 or later	6.5 or later
URS can recognize a new Business Attribute used to represent a Global Interaction Type. You can use this attribute to track the original purpose of an interaction that has moved across T-Servers and/or Media Servers.	Yes	URS/IRD 7.5 or later	7.2 or later	6.5 or later	6.5 or later	7.2 or later	6.5 or later

Table 102: 7.5 Feature and Component Matrix (Continued)

Feature	Multimed.7.5 or 7.6 Compon. required?	URS/IRD version required	Stat Server version required	Custom Server version required	LDS version required	Config Server version required	T-Server version required
URS and ICON now synchronize virtual queue information. This avoids any potential problems with calls getting stuck in virtual queues.	No	URS/IRD 7.5 or later	7.5 or later	6.5 or later	6.5 or later	7.2 or later	6.5 or later
The Service Level routing rule algorithm responsible for the expansion of the current working set of agents from ideally-skilled to non-ideally skilled considers calls in queue. This is especially applicable in a low volume and/or long talk time contact center.	No	URS/IRD 7.5 or later	6.5 or later	6.5 or later	6.5 or later	7.0.1 or later	6.5 or later
Interaction Routing Designer							
In IRD's Interaction Design window, a new Limitations tab in the strategy properties dialog box reflects the configuration limitations associated with the strategy.	Yes 7.5 or later	URS/IRD 7.5 or later	7.2 or later	6.5 or later	6.5 or later	7.2 or later	6.5 or later
In the Target Selection tab of the Routing Selection object, URS accepts agent skills and object properties ("pseudo statistics") as target selection criteria.	No	URS/IRD 7.5 or later	6.5 or later	6.5 or later	6.5 or later	7.0.1 or later	6.5 or later

Table 102: 7.5 Feature and Component Matrix (Continued)

Feature	Multimed.7.5 or 7.6 Compon. required?	URS/IRD version required	Stat Server version required	Custom Server version required	LDS version required	Config Server version required	T-Server version required
The Voice Treatment object, Play Application, now lets you indicate whether a custom parameter is a string or numeric datatype.	No	URS/IRD 7.5 or later	6.5 or later	6.5 or later	6.5 or later	7.0.1 or later	6.5 or later
When editing a business process in IRD's Interaction Design window, you can now add comments.	Yes 7.5 or later	URS/IRD 7.5 or later	7.2 or later	6.5 or later	6.5 or later	7.2 or later	6.5 or later
Interaction Design lets you create a visually less complex flow. Global view allows you to display all business process objects found in the window as well as print them. Deployment view presents the names of the applications, ports and connections.	Yes 7.5 or later	URS/IRD 7.5 or later	7.2 or later	6.5 or later	6.5 or later	7.2 or later	6.5 or later
You can now store IRD re-usable objects in custom as well as default folders of type Script.	No	URS/IRD 7.5 or later	6.5 or later	6.5 or later	6.5 or later	7.0.1 or later	6.5 or later

Table 102: 7.5 Feature and Component Matrix (Continued)

Feature	Multimed.7.5 or 7.6 Compon. required?	URS/IRD version required	Stat Server version required	Custom Server version required	LDS version required	Config Server version required	T-Server version required
New Outbound strategy-building objects let you automate building Calling Lists, finishing the processing Calling List records, rescheduling customer calls, and updating Calling List records. You can also add customer records to Do Not Call lists from within a strategy. Requires Outbound Contact 7.5.	Yes 7.5 or later	URS/IRD 7.5 or later	7.5 or later	6.5 or later	6.5 or later	7.5	6.5 or later
Support of new Outbound Contact capability to assign agents to various Campaigns. The Target Selection tab in both objects adds target type: Campaign Group. Requires Outbound Contact 7.5.	No unless routing non-voice interactions then need 7.5 or later	URS/IRD 7.5 or later	7.5 or later	6.5 or later	6.5 or later	7.5	6.5 or later
Functions SelectDN and SData add the Campaign Group target as an additional parameter. Requires Outbound Contact 7.5.	No unless routing non-voice interactions, then need 7.5 or later	URS/IRD 7.5 or later	7.2 or later	6.5 or later	6.5 or later	7.5	6.5 or later

Table 102: 7.5 Feature and Component Matrix (Continued)

Feature	Multimed.7.5 or 7.6 Compon. required?	URS/IRD version required	Stat Server version required	Custom Server version required	LDS version required	Config Server version required	T-Server version required
The installation package includes strategy bytecode to automatically route outbound calls/interactions to Campaign Groups. Since a pure Genesys Outbound Contact customer does not have the rights to edit strategies, the Universal Routing 7.6 Deployment Guide provides instructions for loading the bytecode. A new strategy option instructs URS to run the strategy. For ERS/NRS inbound voice customers, an editable strategy of the same content is provided as well as utility and sample strategy/subroutines that can be imported, edited, and used as customers see fit. Requires Outbound Contact 7.5.	No unless routing non-voice interactions then need 7.5 or later	URS/IRD 7.5 or later	7.5 or later	6.5 or later	6.5 or later	7.5	6.5 or later
IRD's dialog box for defining custom statistics lets you define statistics based on Java Extensions. You can now enter parameters for JavaCategory	No	URS/IRD 7.5	7.0.2 or later	6.5 or later	6.5 or later	7.0.1 or later	6.5 or later

Table 102: 7.5 Feature and Component Matrix (Continued)

Feature	Multimed.7.5 or 7.6 Compon. required?	URS/IRD version required	Stat Server version required	Custom Server version required	LDS version required	Config Server version required	T-Server version required
Custom Server							
A new Common Log function allows you to write user-defined strings to the same log file as Custom Server. Such strings can be useful for troubleshooting, such as when using Custom Server to retrieve information from a non-SQL database. The sample Router Custom Procedure file (<code>rcp.h</code>) contains the new command for writing to the log file, <code>RC_LOGINIT</code> .	No	URS/IRD 7.5	6.5 or later	7.5	6.5 or later	7.0.1 or later	6.5 or later
Other							
When running the Configuration Database Update script to update a database for storage strategies, the update script for DB2 gives the option of defining a strategy table that allows storing more than one megabyte of data.	No	URS/IRD 7.5	6.5 or later	6.5 or later	6.5 or later	7.0.1 or later	6.5 or later

7.2 Feature and Component Matrix

Table 103 shows what components are required to use the new features and capabilities in Universal Routing 7.2, which can work in a pure voice environment or with Genesys Multimedia components.

Table 103: 7.2 Feature and Component Matrix

Feature	Requires Multimedia 7.2 Components?	URS/IRD version required	Stat Server version required	Custom Server version required	LDS version required	Config Server version required	T-Server version required
Universal Routing Server							
Setting thresholds and counting calls on non-configured DN. To count calls at these DN, you must configure the URS call_monitoring option, the new RStatCallsInQueue statistic, and the new NMTEExtractTargets function (which is used as a helper function). This functionality is applicable only to a single-URS environment.	No	URS/IRD 7.2 or later	6.5 or later	6.5 or later	6.5 or later	7.0.1 or later	6.5 or later
Improved load balancing and ability to compensate for statistics from Stat Server being out-of-sync on account of network delays. You must configure the new URS count_calls option, and the new RStatCallsInQueue and RStatLoadBalance statistics. To be used only in a single-URS environment.	No	7.2 or later	6.5 or later	6.5 or later	6.5 or later	6.5 or later	6.5 or later

Table 103: 7.2 Feature and Component Matrix (Continued)

Feature	Requires Multimedia 7.2 Components?	URS/IRD version required	Stat Server version required	Custom Server version required	LDS version required	Config Server version required	T-Server version required
The SetThresholdEx function replaces the SetThreshold function. It enables you to use variables in statistics parameters.	No	7.2 and later	6.5 or later	6.5 or later	6.5 or later	6.5 or later	6.5 or later
Customization of URS log data using the verbose log option. You can set the verbose level separately for each routing point. You can also change the level of messages.	No	7.2 and later	6.5 or later	6.5 or later	6.5 or later	6.5 or later	6.5 or later
Support of multi-tenant Interaction Server and Universal Contact Server.	Yes	7.2 or later	7.2 or later	6.5 or later	6.5 or later	7.2 or later	6.5 or later
Interaction Routing Designer							
Interface updates—notably, the former Strategy Design view is now called the Routing Design window and the Interaction Workflow view (or IWD view) is now called the Interaction Design window.	Yes (to use the Interaction Design window)	URS/IRD 7.2 and later	6.5 or later	6.5 or later	6.5 or later	7.1 or later	6.5 or later

Table 103: 7.2 Feature and Component Matrix (Continued)

Feature	Requires Multimedia 7.2 Components?	URS/IRD version required	Stat Server version required	Custom Server version required	LDS version required	Config Server version required	T-Server version required
Five new Multimedia objects: <ul style="list-style-type: none"> • CreateEmailOut • CreateNotification • CreateSMS • Identify Contact • Update Contact 	Yes	URS/IRD 7.2 and later	7.2 or later	6.5 or later	6.5 or later	7.0.1 or later	6.5 or later
Improvements to existing objects to better handle open media interactions. The Screen, MultiScreen, and Classify objects handle all text-based interactions in which the content is in the attached data. The Acknowledgement and Autoresponse objects have been extended to apply to all text-based channels, including chat and SMS.	Yes	URS/IRD 7.2 and later	7.2 or later	6.5 or later	6.5 or later	7.0.1 or later	6.5 or later
The Interaction Design window shows Media Servers and the staging queues associated with them.	Yes	URS/IRD 7.2 and later	7.2 or later	6.5 or later	6.5 or later	7.0.1 or later	6.5 or later

Table 103: 7.2 Feature and Component Matrix (Continued)

Feature	Requires Multimedia 7.2 Components?	URS/IRD version required	Stat Server version required	Custom Server version required	LDS version required	Config Server version required	T-Server version required
You can now activate or deactivate all strategies belonging to a specific business process at one time from the Interaction Design window.	Yes	URS/IRD 7.2 and later	7.2 or later	6.5 or later	6.5 or later	7.1	6.5 or later
When importing business processes containing objects with the same names as existing ones, you can now overwrite the existing objects with the imported ones, create the imported objects in an alternative location, or keep the existing objects	Yes	URS/IRD 7.2 and later	7.2 or later	6.5 or later	6.5 or later	7.0.1 or later	6.5 or later

Routing Component Compatibility

This section starts with routing strategy compatibility and continues with Universal Routing Server component compatibility.

No special migration steps are required when migrating strategies from 6.5.x or later to 7.2 and later. Note, however, that you cannot open strategies that use 7.2 or later functionality in IRD 6.5.

Note: Strategies created with the 5.x Strategy Builder are not supported in Universal Routing 7.2 or later. You must recreate them using IRD 7.2 or later. Refer back to Step 4 in “Migration and Upgrade Order” on [page 562](#).

Routing Strategy Compatibility with Framework

[Table 104](#) shows which routing strategy versions are compatible with various versions of Genesys Framework.

Table 104: Strategy Compatibility in Framework Environments

	6.0 and 6.1 Framework	6.5 and 7.0 Framework	7.0.1 and 7.1 Framework	7.2 and 7.5 Framework	7.6 Framework
7.2 strategy	Not supported	Supported except that certain functions require a Framework 7.0.1 or later environment in order to select Business Attributes	Supported	Supported	Supported
7.5 strategy	Not supported	Supported except that certain functions require a Framework 7.0.1 or later environment in order to select Business Attributes	Supported. If implementing Cost-Based Routing, Framework 7.5 or later is required.	Supported. If implementing Cost-Based Routing, Framework 7.5 or later is required.	Supported
7.6 strategy	Not supported	Supported except that certain functions require a Framework 7.0.1 or later environment in order to select Business Attributes	Supported. If implementing Cost-Based Routing, Framework 7.5 or later is required.	Supported. If implementing Cost-Based Routing, Framework 7.5 or later is required.	Supported

Strategy Compatibility with URS/IRD

[Table 105](#) shows the compatibility between routing strategies and URS.

Note: “Supported” in the table below indicates that a strategy created in the version of Universal Routing indicated in a heading cell can be opened/executed by the IRD/URS version in the first column with the exception of objects that did not yet exist. For example, assume you use IRD 7.2 to open a strategy created in Universal Routing 7.5 and that strategy contains one of the Outbound strategy-building objects introduced in 7.5. In this case, URS 7.2 cannot execute that object because it was not coded to do so. Also, see the Note on [page 563](#).

Table 105: Routing Strategy, IRD and URS Compatibility

	5.x Strategies	6.0 Strategies	6.1, 6.5, and 7.0 Strategies	7.0.1 and 7.1 Strategies	7.2 and 7.5 Strategies	7.6 Strategies
URS and IRD 7.6	Not Supported	Supported	Supported*	Supported	Supported	Supported
URS and IRD 7.5	Not Supported	Supported	Supported*	Supported	Supported	Supported
URS and IRD 7.2	Not Supported	Supported	Supported*	Supported	Supported	Supported

*Strategies using the 6.x/7.0 Acknowledgement and Autoresponse objects cannot be used in Business Processes.

Custom Server Compatibility

[Table 106](#) shows which versions of Custom Server are compatible with URS/IRD 7.5 and 7.2.

Table 106: Custom Server and URS Compatibility

	5.x Custom Server	6.x Custom Server	7.x Custom Server
URS/IRD 7.6	Not Supported	Supported	Supported
URS/IRD 7.5	Not Supported	Supported	Supported
URS/IRD 7.2	Not Supported	Supported	Supported

Load Distribution Server Compatibility

Table 107 shows which versions of LDS are compatible with URS/IRD 7.5 and 7.2.

Table 107: Load Distribution Server and URS Compatibility

	LDS 6.5	LDS 7.0	LDS 7.1	LDS 7.2
URS/IRD 7.6	Supported	Supported	Supported	Supported
URS/IRD 7.5	Supported	Supported	Supported	Supported
URS/IRD 7.2	Supported	Supported	Supported	Supported

Note: There is no dependency between IRD and LDS.



Chapter

36

Changes in Universal Routing Through 7.6

This section provides information that you need to upgrade the components and configuration options of Universal Routing to release 7.6 from releases 6.5 through 7.5.

This section only discusses changes (additions, deletions, and modifications) in the product that need to be addressed during the migration process.

The product documentation for each release contains a comprehensive list of changes from release to release:

- Universal Routing 7.0: *Universal Routing 7 Getting Started Guide*, Chapter 2, “Overview.”
- Universal Routing 7.0.1: *Universal Routing 7 Routing With MCR Getting Started Guide*, Chapter 2, “Overview.”
- Universal Routing 7.1: *Universal Routing 7.1 Deployment Guide*, Chapter 2, “Overview.”
- Universal Routing 7.2: *Universal Routing 7.2 Deployment Guide*, Chapter 1, “Overview.”
- Universal Routing 7.5: *Universal Routing 7.5 Deployment Guide*, Chapter 1, “Overview.”
- Universal Routing 7.6: *Universal Routing 7.6 Deployment Guide*, Chapter 1, “Overview.”

This chapter discusses the following topics:

- [Component Changes for Universal Routing](#), page 592
- [Configuration Option Changes](#), page 593
- [Changes to Functions](#), page 600
- [Changes to Strategy-Building Objects](#), page 608
- [Changes to Predefined Statistics](#), page 611

Component Changes for Universal Routing

Table 108 shows new components for Universal Routing introduced between releases 6.5 to 7.6. For component changes in releases from 5.1 through 6.5, see the *Genesys 6.5 Migration Guide*.

Table 108: Component Changes from 6.5 to 7.6

Current Component Name	Type of change	Change Occurred in Version #	Details (optional)
Universal Routing Server	none	N/A	
Interaction Routing Designer	Interaction Workflow Designer incorporated into IRD	7.1	Interaction Workflow Designer is no longer a separate component, but has been integrated into IRD and is available to users who are running Genesys Multimedia (formerly Genesys Multi-Channel Routing).
Custom Server	none	N/A	
Load Distribution Server	none	N/A	
Universal Callback Server	new	7.0	The Genesys Voice Callback product is a new option for Universal Routing.

Configuration Option Changes

Table 109 on [page 593](#) summarizes the changes to the options for specific component(s) of Universal Routing.

Table 109: Configuration Option Changes from 6.5 to 7.6

Component Name	Option/Section Name	Type of Change	Change Occurred in Version #	Details (optional)
Universal Routing Server	hide_private_data	new	7.6.1	<p>When set to true, in addition to its existing functionality:</p> <ul style="list-style-type: none"> • URS will not print in its logs parameters for Web Service requests and also any result that a Web Service returns. • http_bridge will not print in its log parameters and results of Web Service requests. • http_bridge will not generate an xml-soap log.
Universal Routing Server uses this option set in Message Server	lds	new	7.6	<p>If using a Message Server dedicated to handling communications between a group of URSs (in this case, option using has the value of lds), then use option lds to indicate the specific type of communication.</p>
Universal Routing Server	report_reasons	new	7.6	<p>Enables you to add information to interactions regarding the reason for routing for reporting purposes (such as default routing performed by the switch).</p>

Table 109: Configuration Option Changes from 6.5 to 7.6 (Continued)

Component Name	Option/Section Name	Type of Change	Change Occurred in Version #	Details (optional)
Universal Routing Server	report_statistics	new	7.6	To support reporting on load balancing, and to allow for both real-time and historical reporting of calls in transition, use this option to instruct URS to attach additional reporting data to calls.
Universal Routing Server uses this option set in Message Server	using	new	7.6	Facilitates communications between a group of URSs, such as for the purpose of load distribution.
Interaction Routing Designer	inactivity-timeout	new	7.6	Allows you to require that users log back into IRD after a specified period of user inactivity.
Universal Routing Server	call_kpl_time	new	7.5	Fixes the potential problem of calls getting stuck in virtual queues by improving synchronization between URS, T-Server, and various Genesys Reporting components (ICON, Stat Server, and so on).
Universal Routing Server	environment	new	7.5	Informs URS about various environment parameters in case there are some actions URS should undertake to guarantee successful functioning in that particular environment.

Table 109: Configuration Option Changes from 6.5 to 7.6 (Continued)

Component Name	Option/Section Name	Type of Change	Change Occurred in Version #	Details (optional)
Universal Routing Server	inv_connid_errors	new	7.5	Allows you to explicitly specify a list of T-Server error codes that will result in URS aborting a chain of re-routing attempts.
Universal Routing Server	pickup_calls	enhanced	7.5.	Option is extended with a new reverse parameter. When set to reverse, the connection ID list returned by T-Server lists oldest interactions first. This allows the older items previously in queue to be routed before the young items.
Universal Routing Server	strategy	retired in 6.x, re-used in 7.5	7.5	Instructs URS to run a Genesys-supplied strategy to support multi-Campaign agents.
Universal Routing Server	verification_time_agent	new	7.5	If an agent state event is not related to an agent's DN state, (the agent pushes the Ready button, for example), then URS uses $\max(\text{verification_time}, \text{verification_time_agent})$ as the verification time to block the agent.
Universal Routing Server	verification_time_dn	new	7.5	If an agent state event is related to an agent's DN state (agent hangs up the phone, for example), then URS uses $\max(\text{verification_time}, \text{verification_time_dn})$ as the verification time to block the agent.

Table 109: Configuration Option Changes from 6.5 to 7.6 (Continued)

Component Name	Option/Section Name	Type of Change	Change Occurred in Version #	Details (optional)
Universal Routing Server	count_calls	new	7.2	Used to enable URS to calculate the RStatCallsInQueue and RStatLoadBalance statistics for specified DNs.
Universal Routing Server	monitoring_time	new	7.1	Specifies how often URS sends monitoring data to IRD, which can impact performance
Interaction Routing Designer	bytecode	new	7.1	Used when importing strategies to create a strategy that, when exported, is ready to run without compiling.
Universal Routing Server	pulse_time	new	7.1	Specifies the approximate time (in seconds) between consecutive re-checking of target states.
Universal Routing Server	http_port	new	7.0.1	Sets communication parameters with the http_bridge component used for Web Services and Workforce Management 7.0.
Universal Routing Server	skip_targets	new	7.0.1	Allows URS to automatically detect a situation when all target agents are logged out and skip waiting time in this case.
Universal Routing Server	use_agent_capacity	new	7.0.1	Determines whether URS should route based on agent capacity rules.

Table 109: Configuration Option Changes from 6.5 to 7.6 (Continued)

Component Name	Option/Section Name	Type of Change	Change Occurred in Version #	Details (optional)
Universal Routing Server	use_agentid	Enhanced	7.0.1	No longer affects the value of the RequestRouteCall Extension attribute DN. Now the value always contains the DN number as reported by Stat Server. The real access number (old content of attribute DN) is placed in a new Extension attribute called ACCESS.
Universal Routing Server	change_tenant	new	7.0	Used by the Switch to Strategy object. It allows URS to switch interaction content from one Tenant to another Tenant.
Universal Routing Server	close_statistic time	retired	7.0	Statistics are now automatically deleted when the corresponding Configuration Layer object is deleted.
Universal Routing Server	close_unused_statistic	retired	7.0	Statistics are now automatically deleted when the corresponding Configuration Layer object is deleted.
Universal Routing Server	hide_private_data	new	7.0	Prevents URS from showing attached data in its log of T-Library events.
Universal Routing Server	monitor_calls	enhanced	7.0	Allow interactions to be monitored at the strategy/subroutine level in addition to the existing routing point level.

Table 109: Configuration Option Changes from 6.5 to 7.6 (Continued)

Component Name	Option/Section Name	Type of Change	Change Occurred in Version #	Details (optional)
Universal Routing Server	null value	new	7.0	Used when a reply from DB Server contains empty (NULL) values.
Universal Routing Server	prestrategy	new	7.0	Gives consult calls time to merge with the original call and avoid invalid connection-identifier messages.
Universal Routing Server	reg_attempts option	enhanced	7.0	No longer hardcoded to 1; you can now specify the number of attempts to register on a routing point.
Universal Routing Server	report_targets	new	7.0	Enables the collection and reporting of skill and routing target information.
Universal Routing Server	route_consult_call	enhanced	7.0	Extended with a new value: time in milliseconds.
Universal Routing Server	schedule0xnn	new	7.0	Specifies whether strategy schedules can be loaded on routing points.
Universal Routing Server	source	new	7.0	Supports loading strategy schedules on routing points.
Universal Routing Server	use_dn_type	enhanced	7.0	Extended with one additional location in Configuration Layer: It can now be specified on Switches.

Table 109: Configuration Option Changes from 6.5 to 7.6 (Continued)

Component Name	Option/Section Name	Type of Change	Change Occurred in Version #	Details (optional)
Universal Routing Server	use_extrouter, use extrouting_type	enhanced	7.0	Extended with one additional location in Configuration Layer: they can now be specified on Switches.
Universal Routing Server	use_extrouter	enhanced	7.0	Extends its range of valid values in support of external routing.
Universal Routing Server	use_service_objective	new	7.0	Specifies whether to use a predefined baseline Service Objective when selecting interactions.
Universal Routing Server	none	Option/ section renamed		
Universal Routing Server	close_unused_statistic, close_statistic_time, reg_mode	retired	7.x	
Universal Routing Server	backupserver, backup_priority_level, backup_mode, joint_work, log_file_name, log_remove_old_files, log_file_size, log_buffing, log_check_interval, kprl_priority, kpl- interval. Option strategy was retired in 6.x but is reused in 7.5	retired	6.x	

For information about the configuration option changes:

- For 7.0, see the *Universal Routing 7 Reference Manual*, Chapter 5, “Universal Routing Server Options.”

- For 7.01, see the *Universal Routing 7 Routing with MCR Reference Manual*, Chapter 5, “Universal Routing Server Options.”
- For 7.1, see the *Universal Routing 7.1 Reference Manual*, Chapter 5, “Options.”
- For 7.2, see the *Universal Routing 7.2 Reference Manual*, Chapter 4, “Configuration Options.”
- For 7.5, see the *Universal Routing 7.5 Reference Manual*, Chapter 4, “Configuration Options.”
- For 7.6, see the *Universal Routing 7.6 Reference Manual*, Chapter 4.

Changes to Functions

Table 110 summarizes the changes to the functions available in Interaction Routing Designer.

Table 110: Function Changes from 6.5 to 7.6

Component Name	Function Name	Type of Change	Change Occurred in Version #	Details (optional)
Interaction Routing Designer	FirstHomeLocation	new	7.6.1	Returns the value of the FirstTransferHomeLocation field in the T-Server event that started the strategy.
Interaction Routing Designer	SetHomeLocation	new	7.6.1	Allows you to specify the home location for the current call in a strategy.
Interaction Routing Designer	GetUTC, UTCAdd, UTCFromString, and UTCToString.	new	7.6.1	Date and Time functions that you can use when setting the scheduled time in interactions.
Interaction Routing Designer	CountSkillInGroup	enhanced	7.6	Uses the default Stat Server if the Stat Server parameter is missed in the function specification
Interaction Routing Designer	ExcludeAgents	enhanced	7.6	Excludes the agent if the agent was selected as a target and then excluded from the list of valid targets.

Table 110: Function Changes from 6.5 to 7.6 (Continued)

Component Name	Function Name	Type of Change	Change Occurred in Version #	Details (optional)
Interaction Routing Designer	ExtrouterError	new	7.6	Changes the default URS reaction upon failure to get a remote access number. If set to false, URS will continue the attempt to route the call based on the original number.
Interaction Routing Designer	InVQWaitTime	enhanced	7.6	StatExpectedWaitingTime statistic in the formula for the InVQWaitTime function is replaced with max(StatLoadBalance, 0). StatLoadBalance more accurately counts time to wait.
Interaction Routing Designer	StrTargets	new	7.6	Use to implement a load balancing algorithm in your strategies. Facilitates the creation of a comma separated list of targets for use as input parameters to the utility subroutines described below.
Interaction Routing Designer installation package includes rlu.zcf file. When imported into IRD, contains six utility subroutines.	Utility subroutines: rlu_mapc, rlu_mapcar, rlu_mapc_group, rlu_mapc_group_route rlu_select_max, rlu_select_vq_route	enhanced	7.6	Accept a comma-separated list of targets and a corresponding “selecting” procedure and then returns the optimal target.
Interaction Routing Designer	CountSkillInGrup and GetSkillInGroup	enhanced	7.6	Extended to accept more than one target. Instead of a single Agent Group target, you can now specify a comma-separated list of Agents, Agent Groups, Places, or Place Groups.

Table 110: Function Changes from 6.5 to 7.6 (Continued)

Component Name	Function Name	Type of Change	Change Occurred in Version #	Details (optional)
Interaction Routing Designer	DeleteAttachedData	new	7.5	Allows you to delete attached data.
Interaction Routing Designer	ExpandWFActivity	new	7.5	Takes as an argument a Workforce Management Activity name and returns the list of agents assigned to the Activity from current moment of time up to next CutOffTime number of seconds.
Interaction Routing Designer	OnRouteError	new	7.5	allows you to specify how URS should react to specific types of errors.
Interaction Routing Designer	SData and SelectDN functions	enhanced	7.5	Both functions add a new target type called Campaign Group
Interaction Routing Designer	SendEvent	enhanced	7.5	Extends its Event parameter with one more key, tserver. Use to send User Events to any DN on T-Servers to which URS connects.
Interaction Routing Designer	TargetSelectionTuning	new	7.5	Can be used to activate cost-based routing. Causes URS to extend statistic selection using the cost of routing to the specified target as the main criteria.
Interaction Routing Designer	UseAgentStatistics	new	7.5	The StatExpectedWaitingTime statistic in the formula for the InVQWaitTime function is replaced with max(StatLoadBalance, 0). StatLoadBalance more accurately counts time to wait.

Table 110: Function Changes from 6.5 to 7.6 (Continued)

Component Name	Function Name	Type of Change	Change Occurred in Version #	Details (optional)
Interaction Routing Designer	NMExtractTargets	new	7.2	Retrieves information about interactions sent from the Genesys environment to non-monitored DNs.
Interaction Routing Designer	SetThresholdEx	new	7.2	Defines queue or routing point statistical thresholds for determining the availability of such DNs as targets. Replaces the SetThreshold function
Interaction Routing Designer	SetLastError	new	7.1	Checks subroutine input parameters and raises an error condition if one or more parameters are invalid.
Interaction Routing Designer	GetAvgStatData, GetMaxStatData, and GetMinStatData	new	7.1	Calculate a specified statistic for a target list and return the average/max./minimum values of the statistic for the target list.
Interaction Routing Designer	IsSpecialDayEx	new	7.1	Extends IsSpecialDay by adding Time Zone parameter and another parameter that specifies whether to use any time limits in a Statistical Day.
Interaction Routing Designer	SelectTargetsByThreshold	new	7.1	Finds the best available target(s) from a list of targets by applying a statistic with a threshold comparison against the input target list.

Table 110: Function Changes from 6.5 to 7.6 (Continued)

Component Name	Function Name	Type of Change	Change Occurred in Version #	Details (optional)
Interaction Routing Designer	Router	new	7.1	Can return either the name of the URS Application running a strategy or the name of the primary URS Application.
Interaction Routing Designer	BusinessData, BusinessDataINT, InteractionData, InteractionDataINT, UpdateBusinessData, UpateInteractionData	new	7.0.1	Extended support for using interaction and business data (new CME Business Attributes).
Interaction Routing Designer	ExcludeAgents	new	7.0.1	Instructs URS not to route interactions to any agent on the specified list of agents.
Interaction Routing Designer	GetMediaTypeName	new	7.0.1	Supports routing based on agent capacity model. Returns the name of the specified media type making it possible for strategies to analyze custom media types.
Interaction Routing Designer	BlockDN, DeliverToIVR, SelectDN enhanced	new target type	7.0.1	A new target type called DN is added to support non-configurable targets.
Interaction Routing Designer	ActiveServerName	new	7.0.1	Detects and returns the name of the server from the primary/backup pair of servers that URS is actually working with (active) at the moment when the function is called.
Interaction Routing Designer	UseMediaType	new	7.0.1	Supports routing based on agent capacity model. Specifies the media types associated with a target.

Table 110: Function Changes from 6.5 to 7.6 (Continued)

Component Name	Function Name	Type of Change	Change Occurred in Version #	Details (optional)
Interaction Routing Designer	SendRequest	new	7.0.1	Makes it possible to send a request to T-Server; for example, a request to redirect an unanswered call to a local routing point in the case of ring-no-answer.
Interaction Routing Designer	Attach	moved	7.0	Moved to CallInfo category.
Interaction Routing Designer	BlockDN	new	7.0	Blocks and unblocks a DN for a specified period of time. Also see Block DN enhancement on page 604 .
Interaction Routing Designer	CallsWaiting	enhanced	7.0	The list of possible targets is extended to include virtual queues.
Interaction Routing Designer	CreateSkillGroup	new	7.0	Can be used instead of GetSkillInGroup to take full advantage of the redesigned distribution algorithm.
Interaction Routing Designer	ExtensionAttach	moved	7.0	Moved to CallInfo category.
Interaction Routing Designer	ExtensionData	moved	7.0	Moved to CallInfo category.
Interaction Routing Designer	ExtensionUpdate	moved	7.0	Moved to CallInfo category.
Interaction Routing Designer	FindServiceObject	new	7.0	Gives the option of determining the baseline Service Objective for an incoming interaction by reading a Configuration Manager table.

Table 110: Function Changes from 6.5 to 7.6 (Continued)

Component Name	Function Name	Type of Change	Change Occurred in Version #	Details (optional)
Interaction Routing Designer	GetCustomerSegment GetServiceType GetServiceObjective	new	7.0	Give the option of assigning/getting customer segment, service type, and/or service objective attributes to/from incoming interactions.
Interaction Routing Designer	IncrementPriority	new	7.0	Increments interaction priority by the Increment every Interval second.
Interaction Routing Designer	InVQWaitTime	new	7.0	Provides the expected wait time for a call in a Virtual Queue by taking position in queue into account.
Interaction Routing Designer	ListGetDataCfg	new	7.0	Implement the new List object. Returns the specified property of the List element.
Interaction Routing Designer	ListLookupCfg	new	7.0	Implement the new List object. Behaves exactly like the current ListLookup function except that the first parameter is the name of the new List object.
Interaction Routing Designer	PositionInQueue	enhanced	7.0	The list of possible targets is extended to include virtual queues.
Interaction Routing Designer	OnCallAbandoned	new	7.0	Specifies the strategy to use if a call is abandoned. Intended to provide reporting information.
Interaction Routing Designer	SetCallOption	new	7.0	Allows a strategy to override certain URS options

Table 110: Function Changes from 6.5 to 7.6 (Continued)

Component Name	Function Name	Type of Change	Change Occurred in Version #	Details (optional)
Interaction Routing Designer	SetStatUpdate function	new	7.0	Periodically updates statistical data in an interaction without leaving the target selection object.
Interaction Routing Designer	StrReplace	new	7.0	Replaces strings.
Interaction Routing Designer	TargetComponentSelected	new	7.0	Gives the ability to report on why a particular target object was selected.
Interaction Routing Designer	UseAgentState	enhanced	7.0	Format is extended.
Interaction Routing Designer	UseCustomDNType	new	7.0	Controls whether you can route to a specific DN.
Interaction Routing Designer	UseCustomAgentType	new	7.0	Controls whether you can route to a specific Agent.
Interaction Routing Designer	UseCustomPlaceType	new	7.0	Controls whether you can route to a specific Place.
Interaction Routing Designer	UData UDataInt	moved	7.0	Moved to CallInfo category.
Interaction Routing Designer	Update	moved	7.0	Moved to CallInfo category.

Warning!

- In Universal Routing 6.5, the ExpandGroup function made it possible to target all Agents (or Places) of which the Group consisted instead of the Group as a whole. Using the ExpandGroup function in 6.5 resulted in performance degradation at the level of skill-based routing.
- In Universal Routing 7.2 and later, the issue of priority violations for group-based routing has been corrected. As a result, the ExpandGroup function is no longer necessary to handle priority

routing issues. If you continue to use this function, you will experience the 6.5 side effect of a **negative impact on performance**.

For more detailed information about functions, see the *Universal Routing 7.6 Reference Manual*, Chapter 5, “Interaction Routing Designer Functions.”

Changes to Strategy-Building Objects

Table 111 on [page 609](#) only contains changes made between releases 7.1 and 7.5. For additional information about new strategy-building objects and their uses, see:

- Universal Routing 7.0: *Universal Routing 7 Getting Started Guide*, Chapter 2, “Overview.”
- Universal Routing 7.0.1: *Universal Routing 7 Routing With MCR Getting Started Guide*, Chapter 2, “Overview.”
- Universal Routing 7.1: *Universal Routing 7.1 Deployment Guide*, Chapter 2, “Overview.”
- Universal Routing 7.2: *Universal Routing 7.2 Deployment Guide*, Chapter 1, “Overview.”
- Universal Routing 7.5: *Universal Routing 7.5 Deployment Guide*, Chapter 1, “Overview.”
- Universal Routing 7.6: *Universal Routing 7.6 Deployment Guide*, Chapter 1: Overview.”

Also see the *Universal Routing Reference Manual* and *Universal Routing Interaction Routing Designer Help* for each relevant release.

Table 111: Changes to Strategy-Building Objects, 7.1 to 7.6

Object Name	Type of Change	Occurred in Version	Comments
MultiScreen, Screen	enhanced	7.6	Uses screening rule display names instead of object names. This assists in name resolution when business processes containing routing strategies that use these objects are exported and imported back to different environments. The MultiScreen object can get screening data from a variable.
Acknowledgement, Autoresponse, Chat Transcript, CreateEmailOut, CreateNotification, Create SMS, and Forward E-mail	enhanced	7.6	Uses standard response display names instead of object names. This assists in name resolution when business processes containing routing strategies that use these objects are exported and imported back to different environments.
Send Email, Acknowledgement, Autoresponse, Chat Transcript, Reply E-mail From External Resource, Create E-mail Out, Create Notification and Create SMS	enhanced	7.6	You can now use variables along with the e-mail addresses and domains in the From field of Send Email, Acknowledgement, Autoresponse, Chat Transcript, Reply E-mail From External Resource, Create E-mail Out, Create Notification and Create SMS objects.
MultiScreen	enhanced	7,6	There is no longer a limit to the number of screening rules you can attach to the MultiScreen object when you add them one by one.
Web Service	enhanced	7.6	The Web Service object property dialog now allows user to provide parameters that can be used to authenticate (if necessary) Web Service requests during router communication with the specified Web Service.
Play Application	enhanced	7.5	You can now indicate whether a customer parameter is a string or numeric datatype.

Table 111: Changes to Strategy-Building Objects, 7.1 to 7.6

Object Name	Type of Change	Occurred in Version	Comments
MultiFunction	new	7.5	Allows you to specify multiple functions in one IRD object. Can be used for share agent by service level agreement routing.
Add Record	new	7.5	Supports Genesys Outbound Contact. Automate building of Calling Lists by adding new record to a specified Calling List.
Do Not Call	new	7.5	Supports Genesys Outbound Contact. Use to add a phone number to a specified Do Not Call list.
Processed	new	7.5	Supports Genesys Outbound Contact. Use this object as well as Do Not Call to finalize Outbound record processing.
Update Record	new	7.5	Supports Genesys Outbound Contact. Use to update a Calling List record.
Reschedule	new	7.5	Supports Genesys Outbound Contact. Use to reschedule a customer call on a Calling List.
Service Level	enhanced	7.5	Routing rule responsible for expansion of current working set of agents from ideally-skilled to non-ideally skilled now considers calls in queue.
Selection	enhanced	7.5	Accepts agent skills and object properties as target selection criteria. Adds a General tab where you can enter a threshold expression, which can be used for share agent by service level agreement routing
Send E-mail	enhanced	7.5	Adds two new fields: Delivery Status Notification and Message Delivery Notification.
Create Interaction	enhanced	7.5	Adds new Create Contact field.
Route Interaction, Selection, Workbin	enhanced	7.5	Length of timeout field increased to accommodate use of variables.

Table 111: Changes to Strategy-Building Objects, 7.1 to 7.6

Object Name	Type of Change	Occurred in Version	Comments
Web Service	enhanced	7.5	Allows the use of WSDL documents to make it easier to complete the properties dialog box.
CreateEmailOut	new	7.2	Enables you to create a new outbound e-mail.
CreateNotification	new	7.2	Enables you to create an outbound e-mail notification.
CreateSMS	new	7.2	Enables you to create a new message to be sent via an E-Mail-to-SMS gateway.
Identify Contact	new	7.2	Enables you to identify one or more contacts that match selected criteria. If no contact matches, you can create a new contact having the values in the attached data.
Update Contact	new	7.2	Enables you to update or add to information about an existing contact.
Screen, MultiScreen, Classify	enhanced	7.2	Now handle all text-based interactions in which the content is in the attached data.
Acknowledgement, Autoresponse	enhanced	7.2	Now extended to apply to all text-based channels, including chat and SMS.

Changes to Predefined Statistics

Table 112 on [page 612](#) only contains changes made between releases 7.1 and 7.5. For additional information about new predefined statistics and their uses, see:

- Universal Routing 7.0: *Universal Routing 7 Getting Started Guide*, Chapter 2, “Overview.”
- Universal Routing 7.0.1: *Universal Routing 7 Routing With MCR Getting Started Guide*, Chapter 2, “Overview.”
- Universal Routing 7.1: *Universal Routing 7.1 Deployment Guide*, Chapter 2, “Overview.”

- Universal Routing 7.2: *Universal Routing 7.2 Deployment Guide*, Chapter 1, “Overview.”
- Universal Routing 7.5: *Universal Routing 7.5 Deployment Guide*, Chapter 1, “Overview.”
- Universal Routing 7.6: *Universal Routing 7.6 Deployment Guide*, Chapter 1, “Overview,” and Chapter 9, “Load Balancing.”

Also see the *Universal Routing Reference Manual* for each relevant release.

Table 112: Changes to Predefined Statistics, 7.1 to 7.6

Statistic Name	Type of Change	Occurred in Version	Comments
RStatCallsInQueue	enhanced	7.6	This enhanced statistic, which can be used for load balancing, takes into account the number of calls in transition based on currently available information. In this case, it is the number of calls sent to the target by this URS. See note below. If Router Self-Awareness is activated then calls in transition will include calls sent by all URSs participating in the same Self-Awareness group.
Note: Previous to 7.6, the number of calls in transition could apply only to calls routed by the current URS (by the router that calculates this statistic). With Router Self-Awareness mode (see page 567), URSs deployed in a load sharing mode to communicate with each other regarding selected targets and target statistics.			
RStatLoadBalance	enhanced	7.6	This load balancing statistic takes into account the number of calls in transition from the network to the contact center based on currently available information. In this case, it is the number of calls waiting in queue from URS. See above note. If Router Self-Awareness is activated then calls in transition will include calls sent by all URSs participating in the same Self-Awareness group.
RStatExpectedLoadBalance	new	7.6	In contrast to the above statistics, this load balancing statistic uses the <i>expected</i> number of calls in transition to the destination. In this case, it is the expected number of calls waiting in queue from URS. See above note.

Table 112: Changes to Predefined Statistics, 7.1 to 7.6

Statistic Name	Type of Change	Occurred in Version	Comments
RStatLBEWTLAA	new	7.6	This statistic uses the number of calls in transition to the destination based on currently available information. Uses expected waiting time when a call is expected to wait. When a call is not expected to wait, it uses the longest available time among all agents behind the destination queue. See above note.
RStatExpectedLBEWTLAA	new	7.6	Like the above load balancing statistics, this statistic also uses expected waiting time when a call is expected to wait and the longest available agent when a call is not expected to wait. The main difference is that it uses the <i>expected</i> number of calls in transition. See above note.
RStatCallsInTransition	new	7.6	Cannot be used for load balancing distribution, but can be used in a strategy to adjust other statistics received from Stat Server. Works for “queue like” targets (ACDQueue, Routing Point) as well as for Agent, Place, and Agent/Place Group. Returns the number of calls that URS believes are on the way to corresponding targets, but which have not yet arrived. Includes calls distributed by all participating URSs when Router Self-Awareness (see page 567) is activated.
RStatCost	new	7.5	Use to activate cost-based routing.

Table 112: Changes to Predefined Statistics, 7.1 to 7.6

Statistic Name	Type of Change	Occurred in Version	Comments
RStatCallsInQueue	new	7.2	<p>Calculated by URS. Improves load balancing and ability to compensate for statistics from Stat Server being out-of-sync on account of network delays. You must also configure the new URS <code>count_calls</code> option and the new RStatLoad Balance statistic. To be used only in a single-URS environment.</p> <p>Also used when setting thresholds for calls at non-configured DNSs.</p>
RStatLoadBalance	new	7.2	<p>Calculated by URS. Improves load balancing and ability to compensate for statistics from Stat Server being out-of-sync on account of network delays. You must also configure the new URS <code>count_calls</code> option and the new RStatLoad Balance statistic. To be used only in a single-URS environment</p>



Chapter

37

Universal Routing Migration Procedures

This chapter discusses the migration procedures to release 7.6 from releases 6.5 to 7.5. It contains the following sections:

- [Migration of Universal Routing from 6.5 or 7.x to 7.6, page 615](#)
- [Migration of Universal Routing from 5.1, 6.0, or 6.1 to 7.5, page 619](#)

Migration of Universal Routing from 6.5 or 7.x to 7.6

The migration procedure to release 7.6 is essentially the same from releases 6.5 through 7.5.

Note: There is no direct migration from 5.1/6.0/6.1 to 7.x. Instead, you must first migrate to 6.5 as described in the *Genesys 6.5 Migration Guide*. Once migration to 6.5 is complete, you can migrate directly to Universal Routing 7.x.

Preliminary Procedures

Complete these preliminary procedures before starting your migration to Universal Routing 7.6:

1. Review the following documents:
 - *Chapter 2, “Licensing Migration,” on page 41* of this guide.
 - *Genesys Licensing Guide*

2. Install Licensing Manager. Universal Routing 7.6 works with FLEXlm 8.3 or 9.5. However, if your operating system is Red Hat Enterprise Linux AS v4.0 or 3.0 on the 32-bit Intel platform, you must install FLEXlm 9.5 (there is no FLEXlm 8.3 for Linux).
3. Obtain the required licenses. Add license to your license file as specified in *Genesys Licensing Guide*.
4. Migrate Framework as summarized on “Migration and Upgrade Order” on [page 562](#). For information about migrating the layers and components of Management Framework, see “Framework Migration” in this guide.
5. Review “Interoperability Among Universal Routing Components” on [page 563](#).”

Note: The 7.6 releases of Universal Routing Server and Interaction Routing Designer must be installed and run together.

6. Upgrade any other Genesys components that interact with Universal Routing.
For example, to take advantage of the most advanced multimedia interaction handling features, upgrade to Genesys Multimedia.

Migration Procedure

Note: Genesys does not recommend customization of the Configuration Database. However, if you previously customized it (for example, if you added fields or new tables), you must contact Professional Services for help with the migration process. Otherwise, the customization work will be lost during the migration and Genesys cannot guarantee a successful migration.

Once you have completed the Framework migration, follow the procedures below to upgrade Universal Routing.

Note: If you are currently using strategies developed with release 5.x, see step 3 in “Migration and Upgrade Order” on [page 562](#).

1. Install the 7.6 releases of Universal Routing Server (URS) and Interaction Routing Designer (IRD) to different directories on the same computer where the current components are installed.
If you are using the optional Custom Server or Voice Callback Server components, install those as well, using the same procedure.

Note: For installation instructions, see the *Universal Routing 7.6 Deployment Guide*.

2. For rollback purposes (in case the migration fails), export the configuration options from the `Options` tab of the `Application` object for each of your current components to a configuration file. For rollback instructions, see “Universal Routing Server Rollback Instructions” on [page 618](#).
3. Add the new options (described in Table 109, “Configuration Option Changes from 6.5 to 7.6,” on [page 593](#)) to the `Options` tab of the appropriate `Application` object. Also, remove obsolete options, and, if necessary, adjust the values for existing options. For more information, see “Universal Routing Server Upgrade Procedure” on [page 617](#) and “Interaction Routing Designer Upgrade Procedures” on [page 618](#).

Warning!

When upgrading an existing component, you should not create a new `Application` object. Instead, use the existing `Application` object (keeping the original name) and update it by adding the new options available for use with your newly installed executable, removing obsolete options, and, if necessary, adjusting the values for existing options.

Do not create a new `Application` object in Configuration Manager or rename the existing `Application` object

Universal Routing Server Upgrade Procedure

This section provides instructions on how to upgrade to URS 7.6.

1. In Configuration Manager, open the `Properties` dialog box for the URS `Application` object.

Note: To view the `Annex` tab in the `Properties` dialog box, select `Options` from the `View` menu. On the `General` tab of the `Options` dialog box, select the `Show Annex` tab in object properties check box. Click `OK` to close the dialog box.

2. From the `Options` tab, export the current configuration options to a configuration file. This is the same file you created in Step 2 on [page 617](#) for rollback purposes.
3. Open the file in a text editor and compare the list of options in Table 109, “Configuration Option Changes from 6.5 to 7.6,” on [page 593](#) with those in the text file to see if any option is obsolete or replaced in the new release.
Remove or replace those options that are no longer supported.
4. Verify on the `Connections` tab that the proper connections are still in place for URS. See the *Universal Routing 7.6 Deployment Guide* for information on connections.

5. If necessary, change the settings in the remaining tabs of the Properties dialog box.
6. Click OK to save the changes and close the dialog box.

Universal Routing Server Rollback Instructions

If you experience problems upgrading to URS 7.6, you can return to your existing previous URS configuration by doing the following:

1. In Configuration Manager, open the Properties dialog box for the URS Application object.
2. On the Options tab, click the Import from Configurations File icon and locate the configuration file you exported in Step 2 on [page 617](#).
This procedure overwrites the options on this tab with those in the configuration file.
3. If you changed settings on other tabs, return them to their previous settings.
4. Click OK to save the changes and close the dialog box.

Interaction Routing Designer Upgrade Procedures

1. Upgrading Interaction Routing Designer to release 7.6 requires only that you configure and install the latest release (including the necessary connections).

Note: For more information see the *Universal Routing 7.6 Deployment Guide*.

2. Optional. To use the new features and enhanced capabilities of Universal Routing 7.6, open your existing strategies in IRD 7.6 and edit them to use the new features and capabilities described in Table 111 on [page 609](#) and in the Interaction Routing Designer section of Table 100 on [page 567](#). Also, refer back to “Routing Strategy Compatibility with Framework” on [page 586](#) for additional information.
3. Make sure each Person object has an assigned Access Group. Starting with the 7.6 release, IRD implements a new security enhancement. In order to use IRD, each Person object must have an Access Group assigned in the Member of tab of the Person Properties dialog box. Configuration Manager displays a warning message if you attempt to save a new Person object without assigning an Access Group. Any user without an assigned Access Group can open IRD, but can only view the IRD GUI.

4. Starting with the 7.6 release, the security section containing the `inactivity-timeout` option (see [page 575](#)) is presented by default in the `Application Template`. If you are migrating from an old template, then you must manually create the security section in the IRD `Application` object. Then define this option in that section.
5. Optional. IRD 7.6 contains new `Solution Export` and `Solution Import` views, which provide extended import/export functionality.
 - For a high level overview, see the `Migrating Strategies and Other Objects` section in Chapter 1 of the *Universal Routing 7.6 Reference Manual*.
 - For step-by-step instructions on using these views, consult the *Universal Routing 7.6 Interaction Routing Designer Help*.
6. The IRD installation process enables you to configure one or more security banner messages. Users can accept or reject these messages, which can be configured to display every time they log into IRD (as well as other Genesys applications) or on a one-time basis. Decide whether you wish to configure such a message (or messages) and, if so, the content of those messages. For more information on this feature, see the chapter on configuring with the Wizard in the *Universal Routing 7.6 Deployment Guide*.

Migration of Universal Routing from 5.1, 6.0, or 6.1 to 7.5

There is no direct migration from 5.1, 6.0, or 6.1 to 7.6. Instead, you must first migrate to 6.5 as described in the *Genesys 6.5 Migration Guide*.



Part

11

Voice Callback Migration

The chapters in this section describe the migration process for release 6.5, 7.0, and 7.1 of Voice Callback. They also discuss component changes and the other Genesys software that supports and enables Voice Callback 7.1 functionality. This section covers the following:

The information is divided into the following chapters:

- Chapter 38, “Introduction to Voice Callback Migration,” on page 623 discusses the preliminary migration procedures and the migration order for Voice Callback 7.1.
- Chapter 39, “Changes in Voice Callback 7.1,” on page 631 discusses changes (additions, deletions, and modifications) in the product that specifically need to be addressed during the migration process.
- Chapter 40, “Voice Callback Migration Procedures,” on page 643 provides the procedures for migrating Voice Callback from releases 6.5 and 7.0 to release 7.1.



Chapter

38

Introduction to Voice Callback Migration

This chapter discusses the preliminary migration procedures and the migration order for Voice Callback 7.1.

There are three main sections in this chapter:

- [Preliminary Migration Procedures, page 623](#)
- [Order of Migration for 7.1, page 625](#)
- [Interoperability Among Voice Callback Components, page 627](#)

Preliminary Migration Procedures

Follow these procedures before migrating to Voice Callback 7.1.

Database and Operating System Upgrade

Before migration, you might need to upgrade the operating system and/or database used by Voice Callback 7.1. To determine whether you need to perform these upgrades, go to the Technical Support website and consult the *Genesys Supported Operating Environment Reference Manual*:

To check:

To Update the OS and/or Database

1. Go to the Genesys Technical Support website at <http://genesyslab.com/support>.
2. Click the Knowledge Base link.
3. On next page, click the Release Information link.
4. On the next page, click the General link.
5. Click the Genesys Supported Operating Environment link.

Note: Click the [Genesys Supported Operating Systems and Databases](#) link. If you need to upgrade your operating system and/or database, consult your vendor documentation. If you need help in performing upgrades, contact Genesys Professional Services.

Preliminary Migration Procedures

The migration process includes these preliminary procedures for Voice Callback 7.1:

1. Review Chapter 2 of this guide: “Overview of Migration.”
2. Examine the order in which the Genesys software required for Voice Callback 7.1 should be upgraded. See “Order of Migration for 7.1” on [page 625](#).
3. Examine the component changes for Voice Callback 7.1 in section “Component Changes for Voice Callback” on [page 632](#) in [Chapter 39](#). You might also want to look at “Changes to Configuration Options for Voice Callback 7.0 and 7.1” on [page 633](#) in [Chapter 39](#).

Note: Please note that these tables only discuss changes that directly affect the migration of this product. For complete information about “What’s New in This Release” of Voice Callback and how the 7.1 version functions, please see *Voice Callback 7.1 Deployment Guide*. For a complete list of documentation relevant to the migration of this product, see “Reference Materials” on [page 625](#).

4. Review the licensing requirements for Voice Callback 7.1. See Chapter 3 in this guide: “Licensing Requirements.” Also consult *Voice Callback 7.1 Deployment Guide* for specific licensing requirements for VCB. Licensing is no longer based on the number of instances of Universal Callback Server, but is based on the number of callback requests that are in process and that were submitted during a one hour sliding time window.

Note: VCB reports a license violation when excessive callbacks are submitted, but does not stop normal operation. Instead, it rejects callback requests with specific error codes. Also, the ability to request a license in advance of actual callback submission is implemented.

5. Check the interoperability of the components of Voice Callback 7.1 during the upgrade procedures. See “Interoperability Among Voice Callback Components” on [page 627](#).

6. See the *Genesys 8 Interoperability Guide* for information on the compatibility of Genesys products with various Configuration Layer Environments; Interoperability of Reporting Templates and Solutions; and *Gplus Adapters Interoperability*.
7. Review other issues pertaining to the migration of Voice Callback to version 7.1. See “Additional Information about Migration” on [page 628](#).

Reference Materials

- *Genesys Licensing Guide*
- *Voice Callback 7.1 Deployment Guide*
- *Voice Callback 7.1 Reference Manual*
- *Genesys 8 Interoperability Guide*
- *Genesys Supported Operating Environment Reference Manual*

Order of Migration for 7.1

The section presents information that is specific to the applications and components that enable or support Voice Callback.

Multi-Site/ Single-Site and Multi-Tenant Migration

Common interoperability rules apply for Voice Callback components. If the components are compatible, there is no difference between single-site and multi-site configuration. It is possible to migrate all sites or all tenants simultaneously. It is also possible to migrate separate sites independently.

Migration and Upgrade Order

Migrate or upgrade the application components of Voice Callback, the other enabling software, and relevant data for this solution in the following order:

Note: See procedures detailing this order in “Migration Procedures” on [page 644](#).

1. Install Licensing Manager.

Refer to these documents for information about licensing requirements and for instructions on installing the license(s):

- *Genesys Licensing Guide:*
 - Requirements: see “Universal Callback Server,” and “CPD Server”
 - Installation: see “Installing License Manager”
- *VCB 7.1 Reference Manual:*

- “Configuration Dependencies”: See `num-of-licenses` and `license-file`

2. Migrate Management Framework.

Management Framework is the foundation for all Genesys products, solutions, and options. You can migrate to the 7.1 Configuration Layer while still using 6.5 or 7.0 Voice Callback components.

If you want to change DB before Configuration Layer migration, migrate the database, then the data, and run the Configuration Conversion Wizard (CCW).

For information about migrating the layers and components of Management Framework, see “Management Framework Migration” in this guide.

3. Upgrade other prerequisite Genesys components.

When upgrading many components, determine if the first component you upgrade to version 7.1 is backward compatible with the 6.5 or 7.0 components that have not been upgraded, yet. See “Interoperability Among Voice Callback Components” on [page 627](#). See the *Genesys 7 Interoperability Guide* and the *Genesys 8 Interoperability Guide* for information on the compatibility of Genesys products with various Configuration Layer Environments; Interoperability of Reporting Templates and Solutions; and *Gplus* Adapters Interoperability.

4. Update Contact Center configuration (for example, Place Groups, Agent Groups, DNs).

5. Import Solution template for URS.

6. Import Application template.

The Application templates are accessible from the Configuration Manager of Framework:

```
Configuration > Environment > Applications Templates >
```

The *Voice Callback 7.1 Deployment Guide*, section entitled “Importing Application Templates,” provides instructions for importing an application template.

7. Create and configure the Application Object for the components of Voice Callback 7.1. Or reconfigure the existing 6.5 or 7.0 application object.

Note: Check the type of Universal Callback Server Application object. If it is “Outbound Contact Server,” a new application object has to be created, type `Universal Callback Server`.

When you create an Application object for CPD Server, the main configuration options are defined with their default values. If you choose to change these values, refer to these sections in *Voice Callback 7.1 Deployment Guide*.

- “Configuring the Universal Callback Server Application Object”

- “Configuring CPD Server Application Object”
8. Configure component objects.
 9. Migrate data.
This includes solution-specific data such as Calling Lists and Black List data.
 10. Migrate Scripts.
 11. Migrate routing strategies.
 12. Upgrade Agent Desktop.
Refer to Agent Desktop documentation for information about upgrading this application.
 13. Upgrade reporting templates for Voice Callback 7.1.
For information about importing Reporting templates for Voice Callback 7.1, see:
 - *Reporting 7 CCPulse+ Help*, “Using the Import/Export Utility”
 - *Reporting 7 Data Modeling Assistant Help*, “Importing and Exporting Templates”
 - *Reporting Technical Reference Guide for the Genesys 7.1 Release*

Interoperability Among Voice Callback Components

The term *interoperable* means that different versions of Genesys solutions, components, or options can work together compatibly during the migration process.

Interoperability of Genesys products can occur at two levels of migration:

- **Interoperability at the suite-level** means combining different versions of solutions and options during the migration process.
14. **Example:** You can migrate to the Configuration Management Layer of Framework 7.1 while still using 6.5 or 7.0 components. See the *Genesys 7 Interoperability Guide* and the *Genesys 8 Interoperability Guide* for information on the compatibility of Genesys products with various Configuration Layer Environments; Interoperability of Reporting Templates and Solutions; and *Gplus* Adapters Interoperability.
- **Interoperability at the solution-specific level** means combining different versions of the components of a particular solution while upgrading them sequentially during the migration process.

The mixture of components may include executables, applications, routing strategies, scripts, and data that comprise a particular solution.

As you upgrade each of the components in sequence, you will need to know if it is backward-compatible with the other components of Voice Callback.

Example: If you have four components to upgrade, determine if the first component you upgrade to version 7.x will be backward compatible with the three 6.x components that are not upgraded yet.

The following section provides the answer to this important question.

Compatibility Among Components of Voice Callback

Voice Callback 7.1 includes these components:

- Universal Callback Server 7.1
- CPD Server 7.0 (optional)
- CPD Proxy (optional)
- Web API Server 7.0
- Universal Contact Server 7.0 (optional)

Universal Callback Server Universal Callback Server 7.1 operates with these versions of the other components of Voice Callback:

- CPD Server 7.0
- CPD Proxy 7.0

CPD CPD 7.0 operates with these versions of the other components of Voice Callback.

- Universal Callback Server 7.1

Note: CPD Server 7.0 is compatible with Universal Callback Server 7.0 but not with earlier versions of Universal Callback Server.

CPD Proxy CPD Proxy 7.0 operates with these versions of the other components of Voice Callback.

- Multiple CPD 7.0

Web API Server Web API Server 7.0 operates with these versions of other components of Voice Callback.

- Universal Callback Server 7.1

Universal Contact Server Universal Contact Server 7.0 operates with these versions of other components of Voice Callback.

- Universal Callback Server 7.1

Additional Information about Migration

- Review suite-level migration issues.

- For an overview about migration issues, please see Chapter 1, “Migration Roadmap,” on [page 35](#).



Chapter

39

Changes in Voice Callback 7.1

This section provides information to upgrade components and configuration options of Voice Callback from release 6.5 and 7.0 to 7.1. This section only discusses changes (additions, deletions, and modifications) in the product that specifically need to be addressed during the migration process.

See *Voice Callback 7.1 Deployment Guide* for a comprehensive list of changes.

There are two sections in this chapter:

- [Component Changes for Voice Callback, page 632](#)
- [Changes to Configuration Options for Voice Callback 7.0 and 7.1, page 633](#)

Note: Internet Contact Suite (ICS) Callback Server 6.5 is replaced with Universal Callback Server 7.1, which supports a wider range of dialing modes than ICS Callback Server 6.5.

Although Universal Callback Server functionality differs significantly from that of ICS Callback Server, the way it is configured to process callback requests from the Web remains the same. Universal Callback Server 7.1 supports the sections “WebAPIProcessing” and “WebAPIRouting” which have the same options as those found in ICS Callback Server 6.5.

Please refer to *Voice Callback 7.1 Deployment Guide* and *Voice Callback 7.1 Reference Manual* for further information.

Component Changes for Voice Callback

Table 113 shows the component changes for Voice Callback from 6.5 and 7.0 through 7.1.

Table 113: Component Changes from 6.5 to 7.0 and 7.1

Current Component Name	Type of change	Change Occurred in Version #	Details (optional)
Web API Server	New component	7.1	VCB is now capable of handling callback requests coming from the Web. Web API Server is required in order to pass callback-related requests from the Web to VCB Server. (ICS Callback Server 6.5 functionality worked in the same way.) Note: To request a callback IVR could be used, or Web interface could be used.
Universal Contact Server	New component	7.1	Universal Callback Server is capable of storing callback-related communications history in the centralized database that all agents may view. Universal Callback Server uses Universal Contact Server to gain an access to this centralized database. (ICS Callback Server 6.5 functionality worked in the same way.)
CPD Proxy	New component	7.0	A new CPD Proxy, which connects multiple servers, supports call load distribution. The Proxy distributes calls among several CPD Servers when the number of CPD Ports required to service a big Agent Group exceeds the number of ports that a single CPD Server can support. The call load distribution is configurable.

Table 113: Component Changes from 6.5 to 7.0 and 7.1 (Continued)

Current Component Name	Type of change	Change Occurred in Version #	Details (optional)
CPD Server	New dialing mode	7.0	New dialing mode: Agent Reserved Connection.
CPD Server	New functionality	7.0	New functionality: voice and beep-tone announcement for Agent Reserved Connection.
CPD Server	New functionality	7.0	New functionality: voice announcement for Customer Reserved Connection.

For information about all the new features and functions in Voice Callback 7.0, see *Voice Callback 7.1 Deployment Guide*, Chapter 2.

Changes to Configuration Options for Voice Callback 7.0 and 7.1

This section explains the changes to configuration options for the components of Voice Callback 7.0 and 7.01. The options are briefly described in [Table 114](#). Options are discussed in detail in the *Voice Callback 7.1 Reference Manual*. For more information about the options introduced in the 6.5 release, see the *Voice Callback 6.5 Getting Started Guide*.

Table 114: Configuration Option Changes from 6.x to 7.0

Component Name	Option/Section Name	Type of Change	Change Occurred in Version #	Details (optional)
Universal Callback Server	max_proc_interval	New option	7.1	For 6.5 and 7.0 backward compatibility, the value must be set 0.
Universal Callback Server	num-of-licenses	New option	7.0	Universal Callback Server uses these two options for license control.
Universal Callback Server	license-file	New option	7.0	

Table 114: Configuration Option Changes from 6.x to 7.0 (Continued)

Component Name	Option/Section Name	Type of Change	Change Occurred in Version #	Details (optional)
CPD Server	out-of-service-attempts	New option	7.0	CPD Server immediately marks a Dialogic port out-of-service if the server receives a failure message after a predefined number of attempts to connect to that port. This option sets the number of attempts. See also out-of-service-timeout option.
CPD Server	out-of-service-timeout	New option	7.0	Determines how long to wait (in minutes) before using the out-of-service channel again.
CPD Server	destination-busy-timeout	New option	7.0	Prevents CPD Server from waiting indefinitely for the results of call progress detection on a busy signal. This new option specifies the length of time (in milliseconds) that CPD Server will wait for confirmation of the call result from T-Server (EventDestinationBusy) after a Busy call result from the Dialogic board. When the timeout expires, CPD Server accepts the busy call result as correct.
CPD Server	license-file	New option	7.0	Specifies the license address.
CPD Server	num-occ-port-licenses	New option	7.0	Specifies the number of licenses that CPD checks out initially.
CPD Server	number-userdata-pairs-to-print	Option removed	7.0	Specified the number of pairs in UserData to print.

Table 114: Configuration Option Changes from 6.x to 7.0 (Continued)

Component Name	Option/Section Name	Type of Change	Change Occurred in Version #	Details (optional)
CPD Server	Tsrelease	Option removed	7.0	Previously, the value of this option indicated whether to send a release request to T-Server (<code>tsrelease = yes</code>) or not to send a release request to T-Server (<code>tsrelease = no</code>). CPD Server 7.0 queries the DN to find out if any calls remain active.
CPD Server	max-number-ports-to-record	New option	6.5.2	CPD Server is able to create two voice files for outbound calls that it dials: File 1 contains the line recording for the CPD stage. File 2 records the conversation between an agent and the called party if the call result is answer (ASM mode only). The <code>max-number-ports-to-record</code> option specifies the maximum number of agent ports on which to record the voice files at the same time. See these options: <code>cpd-file-name-prefix</code> and <code>conversation-file-name-prefix</code>
CPD Server	cpd-file-name-prefix	New option	6.5.2	The value of this option is a prefix that identifies voice File 1 (Call Result). The default is <code>cpd_</code>
CPD Server	tsclear	New option	6.5.2	This option controls the way a call is released. If <code>tsclear = yes</code> , <code>RequestClearCall</code> is issued to release an active call.

Table 114: Configuration Option Changes from 6.x to 7.0 (Continued)

Component Name	Option/Section Name	Type of Change	Change Occurred in Version #	Details (optional)
CPD Server	line-type	Value changed	6.5.2	A new value dm3 for the line-type option replaced the previous value dm3-isdn.
Universal Callback Server	auto_dial_mode	New option	7.0	Default value: dial_ahead. Valid values: dial_ahead, engaging. Note: dial_ahead means Customer Reserved Connection; engaging means Agent Reserved Connection.
Universal Callback Server	agent_announcement_type	New option	7.0	Option used for announcement for Agent Reserved Connection. If not specified, UCS does not request CPD Server to play a standard announcement to the Agent. This option does not affect the situation when the announcement is recorded by IVR. Valid value: tone or voice.
Universal Callback Server	agent_announcement_prefix	New option	7.0	Option used for announcement for Agent Reserved Connection. Valid value: string that contains full path to voice file.

Table 114: Configuration Option Changes from 6.x to 7.0 (Continued)

Component Name	Option/Section Name	Type of Change	Change Occurred in Version #	Details (optional)
Universal Callback Server	agent_announcement_data	New option	7.0	Option used for announcement for Agent Reserved Connection. This option does not affect the scenario when announcement is recorded by IVR. Valid value: string that contains beep tone parameters or full path to voice file; depends on announcement type specified in the option agent_announcement_type.
Universal Callback Server	agent_announcement_suffix	New option	7.0	Option used for announcement for Agent Reserved Connection. Valid value: string what contains full path to voice file.
Universal Callback Server	delete_ivr_announce_file	New option	7.0	Option used for Recorded Announcement. If not specified or set to false, UCS does not delete VOX files recorded by IVR. Default value: false/no. Valid value: true, false, yes, no.
Universal Callback Server	cust_announcement_prefix	New option	7.0	Option used for Customer Reserved Connection. Valid value: string what contains full path to voice file.

Table 114: Configuration Option Changes from 6.x to 7.0 (Continued)

Component Name	Option/Section Name	Type of Change	Change Occurred in Version #	Details (optional)
Universal Callback Server	cust_announcement_data	New option	7.0	Option used for Customer Reserved Connection. Valid value: string that contains full path to voice file.
Universal Callback Server	cust_announcement_suffix	New option	7.0	Option used for Customer Reserved Connection. Valid value: string that contains full path to voice file.
Universal Callback Server	call_default_routing_timeout	New option	7.0	If not specified or 0, UCS does not perform default routing at all. Valid value: number of seconds.
Universal Callback Server	stat_type	New option	7.0	UCS uses this Type to obtain EWT for Queue that is used in scheduled Callbacks processing. If not specified anywhere, UCS uses <code>AverDistribCallTime</code> . Valid values: any Statistical Type configured on corresponding StatServer. This option could be set for Virtual Queue.
Universal Callback Server	stat_filter	New option	7.0	UCS uses this Filter to obtain EWT for Queue that is used in scheduled Callbacks processing. Valid values: any Name of Filter configured on corresponding StatServer. This option could be set for Virtual Queue.

Table 114: Configuration Option Changes from 6.x to 7.0 (Continued)

Component Name	Option/Section Name	Type of Change	Change Occurred in Version #	Details (optional)
Universal Callback Server	stat_timeprofile	New option	7.0	<p>If not specified anywhere, UCS does not specify it in StatServer API calls.</p> <p>Valid values: any Name of TimeProfile configured on corresponding StatServer.</p> <p>This option could be set for Virtual Queue.</p>
Universal Callback Server	stat_timerange	New option	7.0	<p>If not specified anywhere, UCS does not specify TimeRange in StatServer API calls.</p> <p>Valid values: any Name of TimeRange configured on corresponding StatServer.</p> <p>This option could be set for Virtual Queue.</p>
Universal Callback Server	stat_server	New option	7.0	<p>If value is empty or option is not defined, UCS opens Statistics through first StatServer in this Connections.</p> <p>Valid values: any StatServer Application Name existing in Configuration and included in UCS Connections.</p> <p>This option could be set for Virtual Queue.</p>

Table 114: Configuration Option Changes from 6.x to 7.0 (Continued)

Component Name	Option/Section Name	Type of Change	Change Occurred in Version #	Details (optional)
Universal Callback Server	hide_private_data	New option	7.1	Application-level option that allows UCS to show or hide attached data in the log output. If this option is set to yes or not present, UCS does not show UserData from any telephony event in log output. Default value: yes or true Valid values: true, false, yes, no
Universal Callback Server	check_ewt	New option	7.0	If not specified or set to false, UCS does not take EWT into consideration during callback processing. Default value: false/no. Valid value: true, false, yes, no.
Universal Callback Server	dnc_refresh_interval	New option	7.0	UCS uses this interval to check periodically the Black List Table and update internal hash table in accordance with changes what have been made in table after last check. Default value: 60 Valid value: interval in minutes.
Universal Callback Server	callback_processed	New option	7.0	Default value: true or yes. Valid values: true, false, yes, no.

Table 114: Configuration Option Changes from 6.x to 7.0 (Continued)

Component Name	Option/Section Name	Type of Change	Change Occurred in Version #	Details (optional)
Universal Callback Server	call_progress_orig_dn	New option	7.0	Valid value: <DN name> Points to a DN which should be used as Call Progress Origination DN in auto dial mode when RequestMakePredictiveCall is used.
Universal Callback Server	call_progress_trans_dn	New option	7.0	Valid value: <DN name> Points to a DN which should be used as Call Progress Transfer DN in auto dial mode when RequestMakePredictiveCall is used.



Chapter

40

Voice Callback Migration Procedures

This chapter provides the procedures for migrating Voice Callback from releases 6.5 and 7.0 to release 7.1.

This chapter contains:

- [Migration from 6.5 and 7.0 to 7.1, page 643](#)

Migration from 6.5 and 7.0 to 7.1

This chapter discusses the migration procedures for Voice Callback and other Genesys software that enables and supports it. It includes step-by-step procedures for configuring and installing the Universal Callback Server (UCS), CPD Server (optional), CPD Proxy (optional), and configuration objects that are required to support Voice Callback.

Preliminary Procedures

Complete these preliminary procedures before starting your migration of Voice Callback:

- Licensing** 1. Install Licensing Manager.

Note: You need the license files for 7.1 components.

Before migrating, note this change in the licensing schema of the Universal Callback Server (UCS): UCS 6.5 is licensed “per instance”; that is, each running instance of the server requires a license. Versions 7.0 and 7.1 are licensed “per amount of callback requests in a sliding window”; that is, the number of licenses required depends on the volume of callback requests that Universal Callback Server processes.

Licensing is addressed in these documents:

- *Genesys Licensing Guide*
- Chapter 2, “Licensing Migration,” on [page 41](#) of this guide
- *Voice Callback 7.1 Deployment Guide*, chapter on “Licensing”
- *Voice Callback 7.1 Reference Guide*, chapter on “Licensing” for configuration dependencies and options.

- Framework** 2. Migrate Framework from 6.5 or 7.0 to 7.1 (except for Stat Server with version 7.0.300.08 and up).

All Genesys products are built on Genesys Framework. As an option of Universal Routing, Voice Callback requires the Framework components that are specified in the *Universal Routing 7 Deployment Guide*. For information about migrating the layers and components of Management Framework, see See “Framework Migration” on [page 57](#) in this guide.

Migration Procedures

Follow these migration procedures:

1. Update the Contact Center configurations specific to VCB.
 - DNs (Routing Points, Virtual Routing Points, Virtual Queues, Agent’s DNs)

Note: See *Voice Callback 7.1 Reference Manual*.

- Universal Routing** 2. Upgrade Universal Routing

Enterprise Routing (ER) or Network Routing (NR) is required for VCB. The Universal Routing Server, which enables both ER and NR, requires additional configuration for Voice Callback.

Note: Review “Interoperability Among Voice Callback Components” on [page 627](#) before you upgrade the VCB-specific components as shown in the following steps.

Universal Callback Server

3. Import the Application Template for the Universal Callback Server. Universal Callback Server is the primary component of Voice Callback. See *Voice Callback 7.1 Deployment Guide*, section entitled “Importing Application Templates.”
4. Create and configure the Application Object for Universal Callback Server 7.1.
OR
Reconfigure existing Application Object for Universal Callback Server 7.1.

Note: If objects and components have been customized, contact Professional Services for help.

5. Install Universal Callback Server.

For detailed instructions, see *Voice Callback 7.1 Deployment Guide*, sections called “Installing Universal Callback Server on Windows” and “Installing Universal Callback Server on UNIX”

Note: For proper functionality, installation must be made into a new separate directory.

Rollback Procedures: If the upgrade of Universal Callback Server 7.1 fails, simply uninstall Universal Callback Server 7.1.

**CPD Server
(optional)**

6. Import Application template for CPD Server 7.0.

A CPD Server is optional. If you want call progress detection (CPD) in the auto-dial mode, then you need the CPD Server.

7. Create and configure the Application Object for CPD Server 7.0.

For assistance with manual configurations, refer to the *Voice Callback 7.1 Deployment Guide*, chapter on “Configuring CPD Server Application Object.”

8. Install CPD Server.

See *Voice Callback 7.1 Deployment Guide*, section called “Installing CPD Server on Windows.”

Note: For proper functionality, installation must be made into a new separate directory.

Rollback Procedures: If the upgrade of CPD Server 7.0 fails, simply uninstall CPD Server 7.0.

**CPD Proxy 7.0
(Optional)**

9. Import the Application template for CPD Proxy 7.0 if you choose to use this component.

The optional CPD Proxy performs load-balancing by distributing calls among various CPD Servers when the volume of calls is high.

10. Create and configure the Application Object for CPD Proxy 7.0.

For assistance, refer to the *Voice Callback 7.1 Deployment Guide* on “Configuring CPD Proxy.”

11. Install CPD Proxy.

Note: For proper functionality, installation must be made into a new separate directory.

Rollback Procedures: If the import and configuration of CPD Proxy 7.0 fails, simply uninstall CPD Proxy.

- Web API Server** 12. Internet Contact Suite (ICS) Callback Server 6.5 is replaced with Universal Callback Server 7.1 that uses Genesys 7 Web callback features.

Although Universal Callback Server functionality differs significantly from that of ICS Callback Server, the way it is configured to process callback requests from the Web remains the same. Universal Callback Server 7.1 supports the sections “WebAPIProcessing” and “WebAPIRouting” which have the same options as those found in ICS Callback Server 6.5.

See *Multi-Channel Routing Event Media Deployment Guide* for installation and configuration procedures.

- Universal Contact Server (optional)** 13. VCB 7.1 uses Universal Contact Server for communication history between agents and customers, regardless of callback request origination (Web, IVR, Agent Desktop). ICS Callback Server 6.5 had this functionality in previous releases.

See *Multi-Channel Routing Event Media Deployment Guide* for installation and configuration procedures.

- Other Configuration Objects** 14. Configure the new objects for Voice Callback. See *Voice Callback 7.1 Deployment Guide* for details.

- Database Access Point object(s) for Black List access
- Table Access object(s) for Black List access
- Default Routing DNs
- Statistical Days
- Statistical Tables
- Time Zones

- Data** 15. Migrate data specific to Voice Callback:
- a. Calling List data

Note: The format of the tables where callback processing information is stored did not change between 6.5 and 7.0 and 7.1. Therefore, you can use old tables. If you wish to use new ones, it is recommended that you do not create these new tables in the database since Universal Callback Server 7.1 will create them on first starting. If you have some information stored in your old tables, it is not necessary to copy it to your new tables since at the moment of upgrade there should be no callbacks left for processing. Therefore, old tables will hold only obsolete data.

- Black List Table** b. Black List Table

In addition to the calling list, Universal Callback Server 7.1 has another connection to the database for the Black List table. This Black List table is

configured via a separate Table Access Object. For details, refer to section on “Black List Blocking,” in the *Voice Callback 7.1 Deployment Guide*.

This is the same situation with the callback processing information tables: Universal Callback Server 7.1 will create the Black List table automatically on first starting. After that, you can populate this table with the phone numbers you want to exclude from callback dialing.

- | | |
|-----------------------------------|--|
| Interactive Voice Response | <p>16. Migrate IVR</p> <p>To request a callback, an Interactive Voice Response (IVR) could be used, or a Web interface could be used.</p> <p>Voice Callback can use an Interactive Voice Response (IVR), such as Genesys Voice Portal (GVP), Voice Treatment Option (VTO), or another Genesys-compliant IVR.</p> <p>VTO is a behind-the-switch IVR. If you want to use another type of IVR, such as an in-front-of-the switch IVR, then the IVR Driver and IVR Server are required. The IVR Driver might require configuration for Voice Callback. See IVR Driver documentation for this information.</p> |
| IVR Scripts | <p>17. Migrate IVR scripts.</p> <p>For additional information about IVR scripts, see <i>Voice Callback 7.1 Deployment Guide</i>:</p> <ul style="list-style-type: none"> • Designing IVR Scripts • Implementation of IVR Script Logic |
| Routing Strategies | <p>18. Migrate routing strategies</p> <p>See <i>Voice Callback 7.1 Deployment Guide</i>, sections on “Routing Strategy Design Considerations” and “Routing Strategy Logic.”</p> |
| Agent desktop | <p>19. Migrate Agent Desktop.</p> <p>VCB 7.1 is capable of working without an agent desktop in auto-dial mode; however, an agent desktop such as Genesys Agent Desktop (GAD) significantly increases productivity.</p> <p>Agent desktops providing preview support for ICS Web callback 6.5 also provide VCB 7.1 preview support.</p> <p>For agent desktops supporting both VCB 7.1 and ICS 6.5 Web callback, the interface is merged into one: callbacks are supported by the same agent’s UI regardless of callback request origin.</p> |

Note: Consult Professional Services regarding migration of any and all customized Genesys products.



Part

12 **Voice Treatment Option Migration**

This section describes the migration process from releases 6.1 and 6.5 to release 7 of Voice Treatment Option product. It also discusses component and option changes and the other Genesys software that supports and enables Voice Treatment Option functionality. This part has the following chapter:

- [Chapter 41, “Migrating Voice Treatment Option,” on page 651](#) describes how to migrate Voice Treatment Option (VTO) 6.5 to VTO 7.0. It also describes how to upgrade components that belong to VTO after Framework has been successfully migrated.



Chapter

41

Migrating Voice Treatment Option

Voice Treatment Option migration information is considered to be a part of Universal Routing migration, because routing strategies frequently send incoming calls for voice treatments. For example, each caller can be greeted with a recorded message and prompted for an account number.

The following sections describe how to migrate Voice Treatment Option (VTO) 6.5 to VTO 7.0. They also describe how to upgrade components that belong to VTO after Framework has been successfully migrated. The information is divided among the following topics:

- [General Instructions for VTO 7.0, page 652](#)
- [New in the Release 7.0.1 VTO, page 653](#)
- [New in the Release 7.0 VTO, page 653](#)
- [Component Compatibility for VTO 7.0, page 653](#)
- [Migration to VTO 7.0, page 655](#)

As you migrate to VTO 7.0, you should also refer to the user documentation for more in-depth information. In particular, refer to:

- *Voice Treatment Option 7 Voice Treatment Server User's Guide*, which will help you deploy the Voice Treatment Server (VT Server) component. This guide also describes how to start and stop this component once it has been installed and configured.
- *Voice Treatment Option 7 Voice Treatment Manager User's Guide*, which will help you deploy the Voice Treatment Manager (VT Manager) component.

General Instructions for VTO 7.0

The information in this section will help you prepare for the migration of VTO 6.5 to 7.0. This section first discusses the dependence of VTO on Framework components. It then explains the changes in VTO from release 6.5 to release 7.0. The following section describes the new features and enhancements in VTO 7.0.

Before Migrating VTO

Before migrating VTO to the 7.0 release, you must first migrate the configuration environment. Although the VTO 7.0 components are compatible with the previous releases of VTO, Framework, and Universal Routing components, to take full advantage of VTO 7.0 functionality, all Genesys components are recommended to be release 7.0 or later. Ensure that your Framework components versions are not lower than those listed in Table 116, “Minimal Version of Dependent Components,” on [page 654](#). The Framework section of this guide explains the process for migrating the Framework components.

Note: Review the licensing requirements for Framework 7.0. See Chapter 2, “Licensing Migration,” [page 41](#).

Component Changes from 6.5 Through 7.0

[Table 115](#) lists component changes in VTO from release 6.5 through release 7.0. For a list of changes to Framework components, see the *Framework 7 Getting Started Guide*.

Table 115: Component Changes in VTO

Current Component Name	Type of Change	Change Occurred in Release #	Details (Optional)
Voice Treatment Server	Upgraded from 6.5 release	7.0	
Voice Treatment Manager	Upgraded from 6.5 release	7.0	
Voice Treatment Option Configuration Wizard	Upgraded from 6.5 release	7.0	Includes new Voice Treatment Option Export/Import Wizard

New in the Release 7.0.1 VTO

This release includes the following new features:

- VTO 7.0.1 adds support of DM3 Dialogic boards, specifically DM/V Series, by implementing its call control functionality through Dialogic GlobalCall software layer.
- The list of supported encoding algorithms and parameters is extended to match those supported by the DM/V Dialogic boards.
- Voice Treatment Server 7.0.1 enables the use of Advanced Disconnect Detection Protocol (ADDP) in its connections to Configuration Server and T-Servers.
- New VTODBC sample provides the reference implementation of VTO Extension Action which enables VTO Scripts to retrieve or modify data in an ODBC-compliant SQL DBMS, by running any type of (optionally) parameterized SQL queries against the database.
- The possibility to call VTO Wizard directly from the Wizard Manager.

New in the Release 7.0 VTO

A feature change in release 7.0 of VTO includes:

- Export/Import Wizard—Scripts, Voice Files and Actions can now be exported and then imported into a regular directory.

Component Compatibility for VTO 7.0

Because some VTO 7.0 components are compatible with previous releases of Framework and VTO components, you might wish to maintain your current versions of some of the components while migrating others to release 7.0 or later. While deciding whether or not to do so, consult Table 116, “Minimal Version of Dependent Components,” on [page 654](#).

Note: To take full advantage of VTO 7.0 functionality, all Genesys components are recommended to be release 7.0 or later.

Table 116: Minimal Version of Dependent Components

Components	VT Server 7.0	VT Manager 7.0	VTO Configuration Wizard	VTO Export/Import Wizard 7.0
VT Server	5.1.028 ¹	5.1.028 ⁴	6.5.100 ⁷	any ⁸
VT Manager	any ²	6.5.100 ⁵	6.5.100 ⁷	any ⁸
VTO Configuration Wizard	7.0 ³	7.0 ³	Not Applicable	7.0 ³
VTO Export/Import Wizard	Not Required	Not Required	Not Required	Not Applicable
T-Server	6.0/6.5 ¹²	Not Required	Not Required	Not Required
Configuration Server	5.1	6.0 ⁶	6.0	6.0
Management Layer (LCA)	6.5 ⁹	Not Required	Not Required	Not Required
FlexLM License Server	8.3c ¹⁰	Not Required	Not Required	Not Required
Licenses	VTPort 7.0	Not Required	Not Required	Not Required
Dialogic software	System Relapse 5.1.1, Service Pack 1 ^{10, 11}	Not Required	Not Required	Not Required
Dialogic hardware	^{10, 13}	Not Required	Not Required	Not Required

1. VT Servers depend on each other only if they are run concurrently within the same configuration environment configured to serve the same Tenant(s), that is, replicate voice recordings between each other. In such configurations, VT Server 7.0 shall not run concurrently with VT Servers prior to versions 5.1.028.
2. VT Manager is not required to run VT Server. VT Server 7.0 is capable of playing back scripts created or updated with VT Manager 7.0 and any earlier versions.
3. Required for configuration only. Not required at runtime
4. Scripts created or updated with VT Manager 7.0 can be played back by VT Server 5.1.028 or later. Scripts which use features introduced in the later versions of VT Manager require a corresponding version of VT Server in order to be interpreted correctly.
5. Although earlier versions of VT Manager are capable of handling scripts created or updated with VT Manager 7.0, features introduced in the later versions of VT Manager can be lost if the scripts are updated with the older VT Manager.

6. With Configuration Server 7.0, VT Manager 7.0 is required. Earlier versions of VT Manager can fail to update some scripts imported or migrated from configuration environments prior to 7.0.
7. Although VTO Configuration Wizard 7.0 can be used to configure VTO components prior to versions 6.5.100, the Wizard does not recognize features existing in earlier versions of the VTO components. The Wizard, therefore, will not allow the configuration of features which did not exist in the older VTO components and consequently such features will not function.
8. The Export/Import procedure preserves the format, version and data specific for the version of VT Manager used to create or update the original scripts. In order for the features used in the scripts to be interpreted correctly, VT Manager and VT Server in the scripts' destination environment must not older than the corresponding components used in the scripts' original environment.
9. LCA and other Management Layer components are not required to run VT Server. In order for the layer to monitor and manage VT Server, a minimum 6.5 version of LCA should be installed on VT Server's host.
10. Not required to run VT Server in the Demo Mode.
11. Dialogic software is not required to run VT Server in the Demo Mode.
12. Refer to the *Genesys Supported Media Interfaces* document for the list of supported T-Servers and their versions.
13. Refer to the *Genesys Supported Media Interfaces* document for the list of supported Dialogic boards.

Migration to VTO 7.0

You should plan your migration to VTO 7.0 carefully. This will save time and ensure a smooth transition.

The information in this section is intended for someone who is familiar with VTO, and has participated in routing training, and understands such Genesys terms as solution, application objects, and components in the context of Genesys software.

The following information describes the migration from release 6.5 to 7.0 for VTO components only. However, it is also applicable for migrating from earlier VTO releases.

Upgrading Software Components

If you have VTO running with Framework 5.1, 6.0, or 6.1, Genesys recommends that you migrate to Framework 7.0 or later.

If you wish to upgrade selected components, before upgrading VTO, you need to upgrade your Framework components to (at minimum) the versions not lower than those listed in [Table 116](#), “Minimal version of dependent components”.

Script Migration

All VTO objects - Scripts, Voice File Descriptors, and actual voice file recordings created using all previous versions of VTO can be used and maintained successfully by VTO 7.0. No special migration procedures are required.

Note: As soon as an older object is modified with a newer version of VTO components, however, it may become incompatible with the older versions of VTO and vice-versa. A newer object that is modified with an older version of a VTO component may lose its newly introduced features. It is therefore necessary to upgrade all VTO components — all installed Servers and Managers — at the same time.

VTO Upgrade Procedures

Before upgrading VTO, you need to have installed both the Genesys Common Wizard Set and the Genesys Universal Routing Configuration Wizard.

The following sections describe upgrading VTO initially deployed as an optional component of the Enterprise Routing Solution (ERS). VTO components not configured as a part of any solution can be upgraded individually. Refer to the [Upgrading individual VTO components](#) section below for additional instructions.

Installing VTO Configuration Wizard

To start upgrading VTO, install the VTO Configuration Wizard. Even if you already have a VTO Wizard installed, running its Setup ensures that you use an up-to-date version.

Note: To eliminate the need for the computer to reboot after the Wizard installation, make sure that the Configuration Manager, the Wizard Manager, the Solution Control Interface and all open Configuration Wizards are closed.

Note: The VTO Wizard can be updated with each maintenance release of VTO. The look and sequence of the Wizard dialog boxes you see may be slightly different from the images in this document. Additional dialog boxes may appear to reflect newly added features or options. In case of discrepancies with this document, refer to the Wizard's instructions. Also refer to the VTO Wizard Advisory and VT Server release notes.

To install the Wizard, run Setup from the root directory of the VTO Product DVD. The setup installs the VTO Configuration Wizard and updates all necessary components of the Configuration Framework Wizard. If requested, reboot the computer before proceeding further.

Starting VTO Wizard

The way you start the VTO Wizard depends on whether you deployed VTO as an option of Enterprise Routing or independently. In both cases the VTO Wizard will help you to upgrade VTO components and create a configuration environment to run them. The only difference is, if you configured VTO within the Enterprise Routing Solution, VTO components are associated with this specific solution, so they can be managed as part of this solution in the Configuration Management Layer. VTO components deployed independently can be associated with the Enterprise Routing Solution after the initial deployment and configuration process is complete.

Starting the VTO Wizard to Upgrade VTO as Option for Enterprise Routing Solution

If you have Enterprise Routing Solution already configured, to start VTO Wizard and upgrade VTO within the existing Enterprise Routing Solution:

1. Start the Genesys Wizard Manager.
2. Login to the configuration from the opening window of the Wizard.
3. Select the Enterprise Routing link on the left-side of the window. The right-side of the window displays *Enterprise Routing* (see Figure 20 on [page 658](#)).
4. In the list of installed Enterprise Routing solutions, select the solution in which you plan to deploy VTO; then, click **Properties**. This opens the properties of the selected solution.
5. Click the **Options** tab and select **Voice Treatment Option** (see Figure 21 on [page 659](#)).

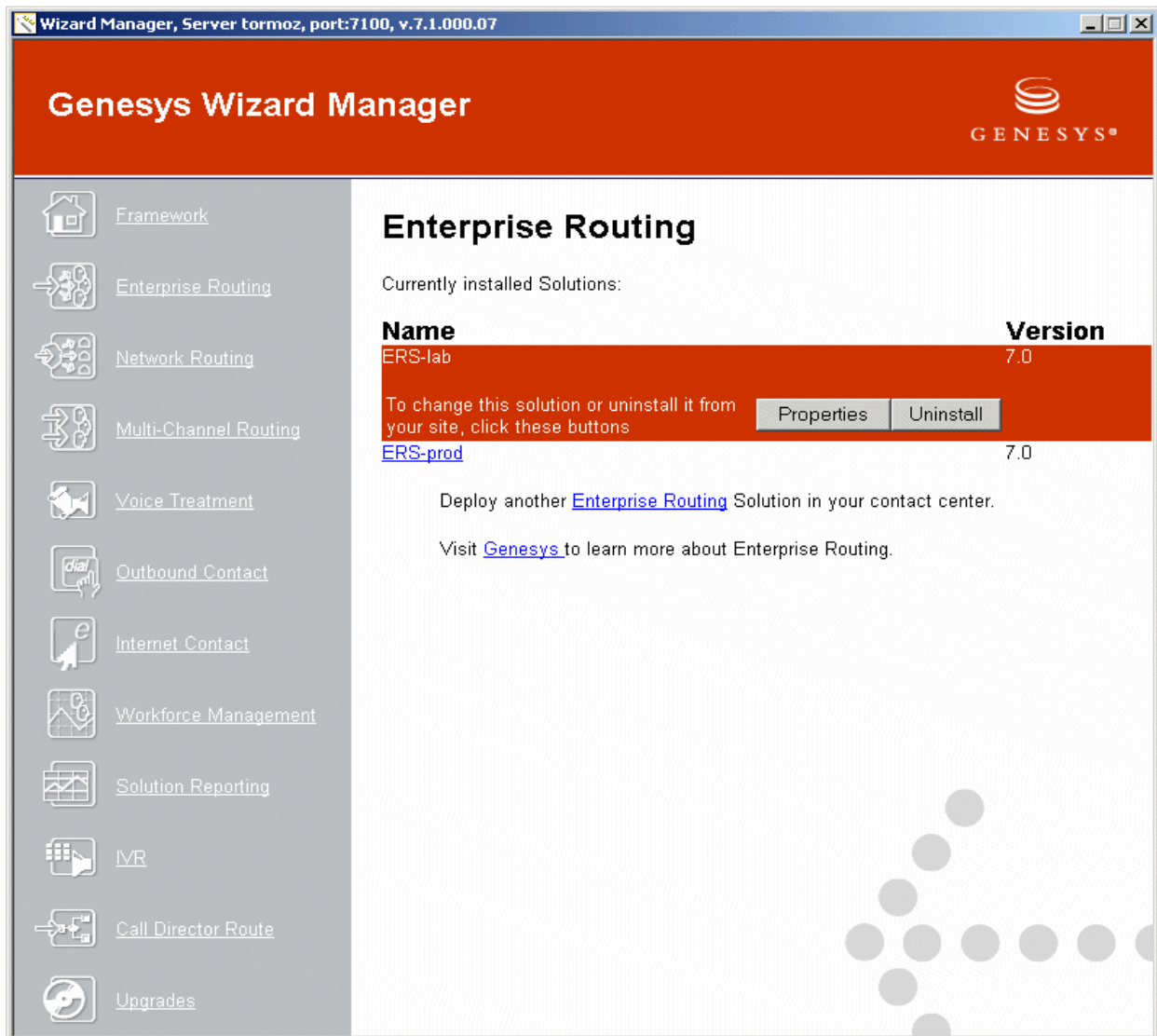

Figure 20: Genesys Wizard Manager—Enterprise Routing

6. If Voice Treatment Option in the list of options is shown as Not Installed, this means that you have not yet added VTO components to this solution. It is recommended that you keep VTO components configured within the Enterprise Routing Solutions so that the entire solution can be configured with the Configuration Framework and managed with the Management Layer as a single entity. Before proceeding with the upgrade you need to add already deployed VTO components to the Solution. Refer to Adding VTO to the Enterprise Routing Solution section below.

7. If VTO components have previously been added to the solution, the state of the Voice Treatment Option in the list will be shown as Installed. The Upgrade button will be enabled.

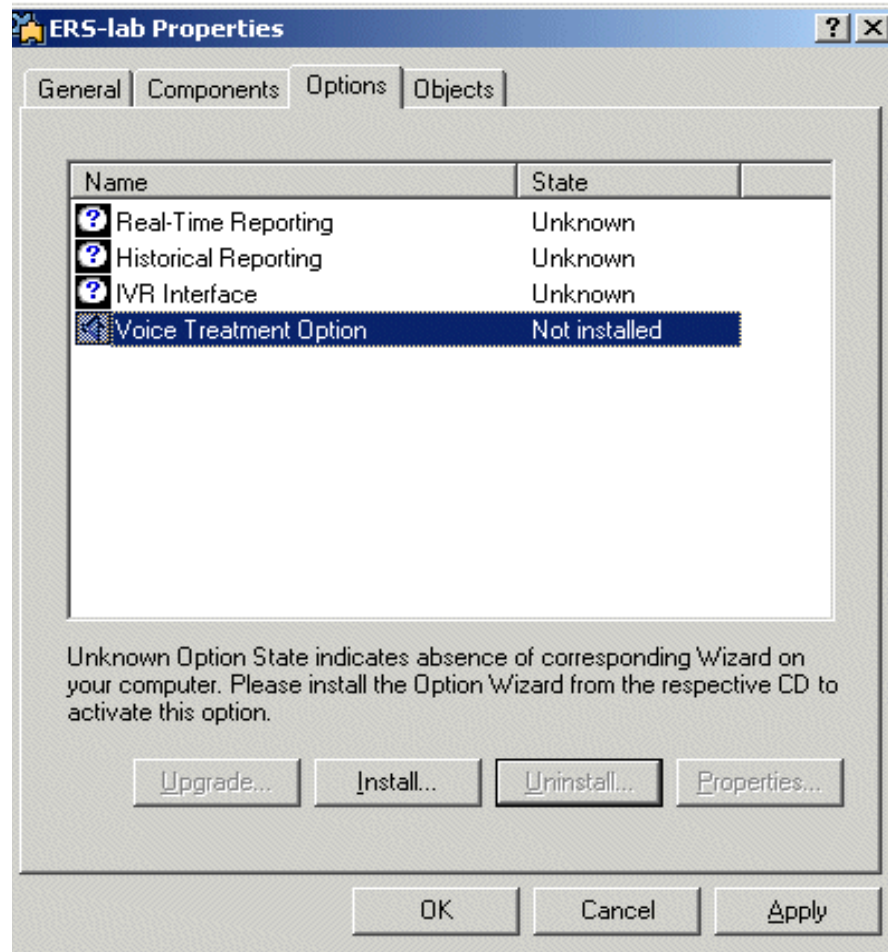

Figure 21: ERS Properties

8. Click Upgrade. This starts the Genesys Voice Treatment Option Wizard (see Figure 22 on [page 660](#)).

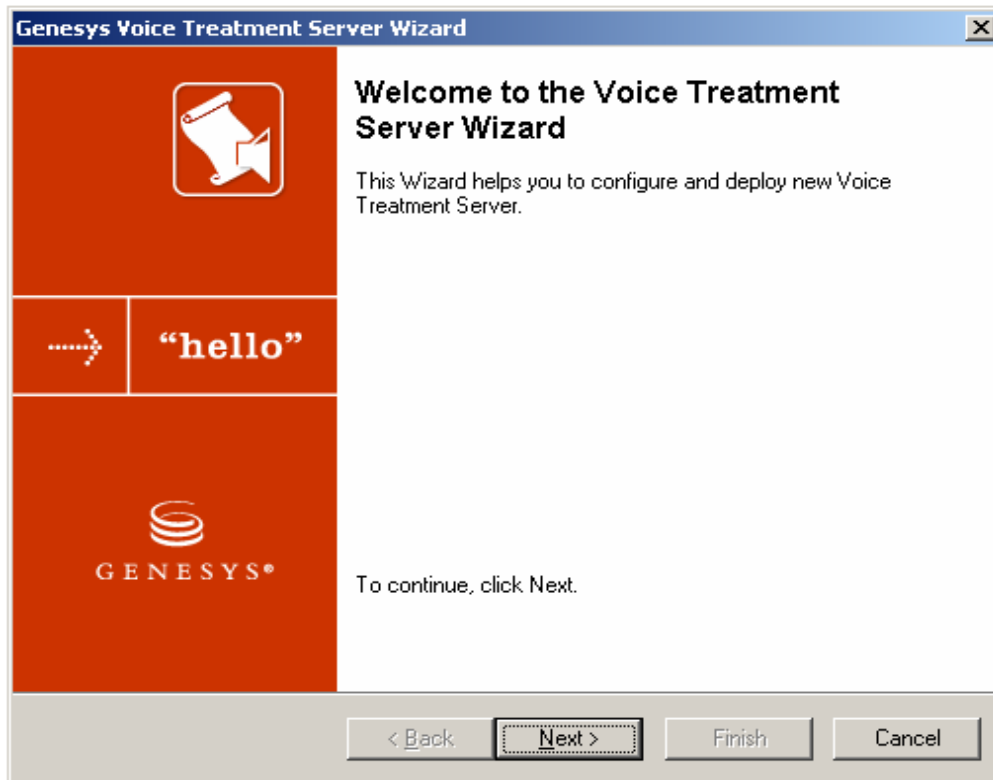

Figure 22: Genesys Voice Treatment Option Wizard

Starting the VTO Wizard to Upgrade VTO Independently from Enterprise Routing

To start the VTO Wizard and deploy VTO independently from Enterprise Routing:

1. Start the Genesys Wizard Manager.
2. Login to the configuration from the opening window of the Wizard.
3. Select the Voice Treatment link on the left-side of the window. This feature is available from 7.0.1 Release. The right-side of the window displays the Voice Treatment page. See Figure 23 on [page 661](#).
4. Click the Upgrade link. This starts the Genesys Voice Treatment Option Wizard. See [Figure 22](#).

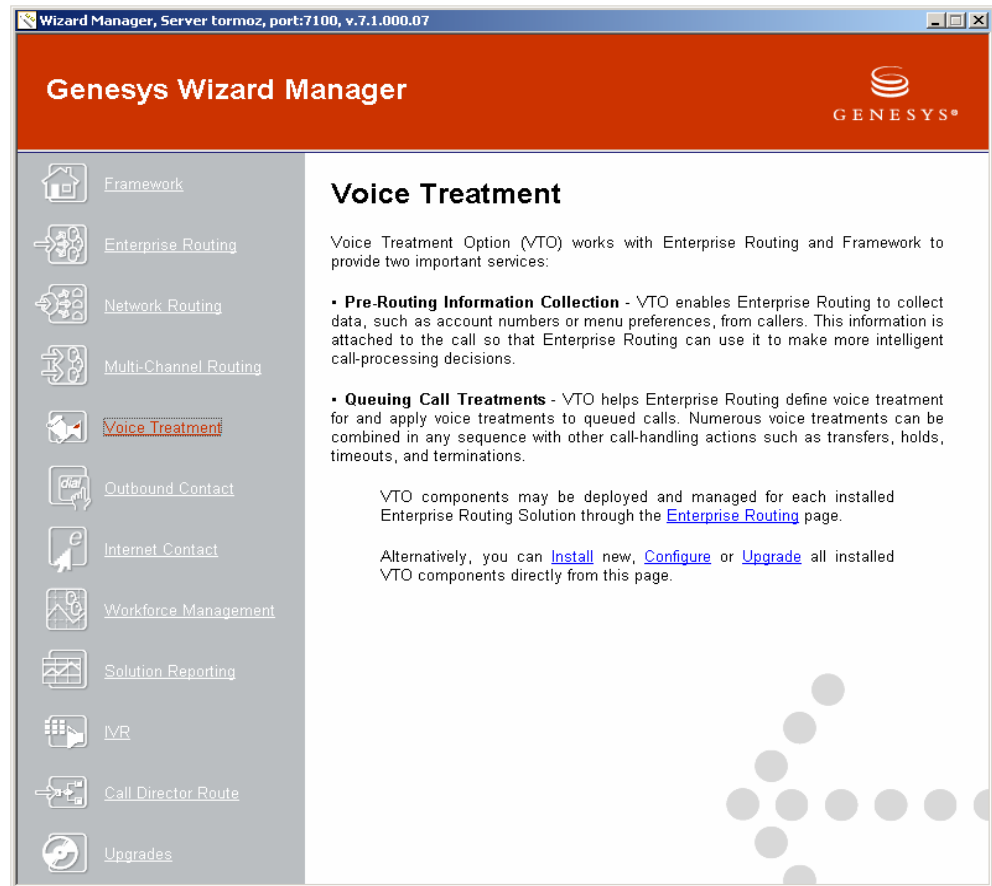

Figure 23: Genesys Wizard Manager—Voice Treatment

Upgrading VT Servers

The first Wizard page lists the Voice Treatment Servers. If you run VTO Wizard from Enterprise Routing Solution you will see only VT Servers configured within the selected Solution. To add another already existing VT Server to the solution click the Add. Then select the existing VT Server from the Browse window.

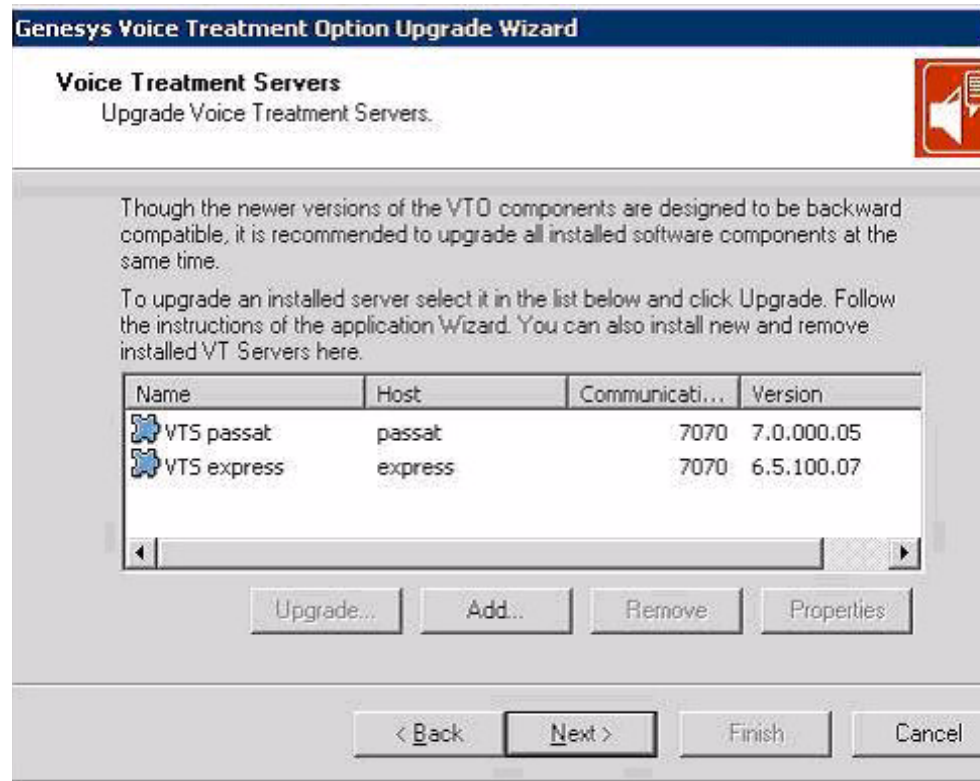

Figure 24: VTO Upgrade Wizard—Voice Treatment Servers

1. Select the Voice Treatment Server you are going to upgrade, and click Upgrade. This launches the Voice Treatment Server Upgrade Wizard. See Figure 25 on [page 663](#).

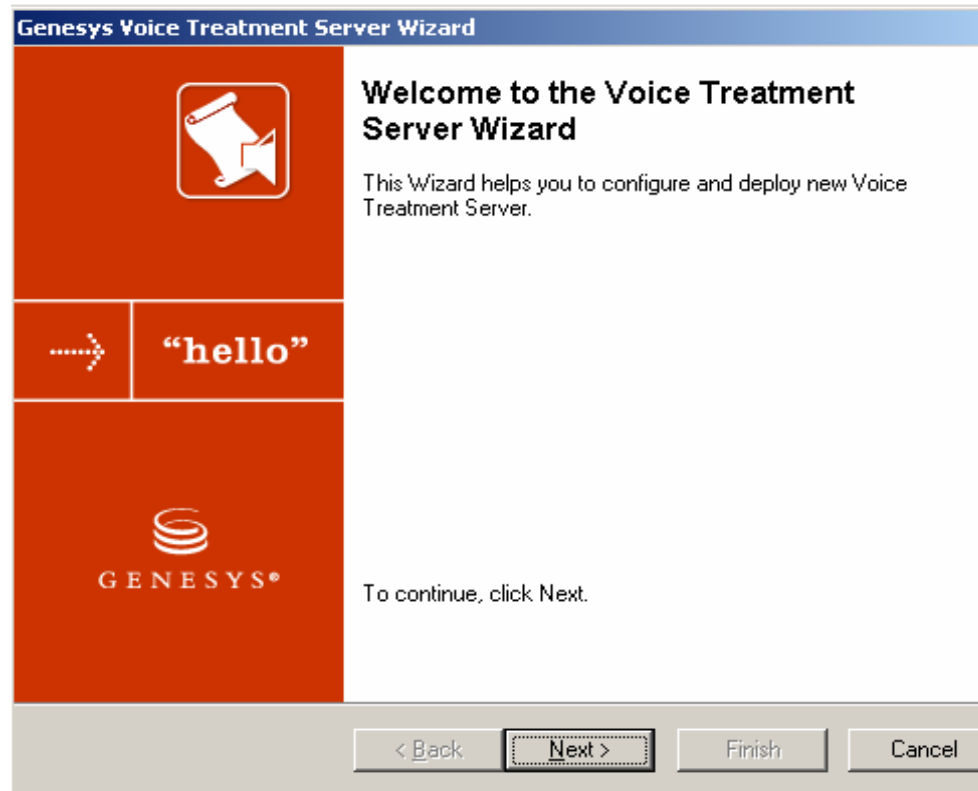

Figure 25: Voice Treatment Server Upgrade Wizard

The next window displays basic information about the application you are going to upgrade.

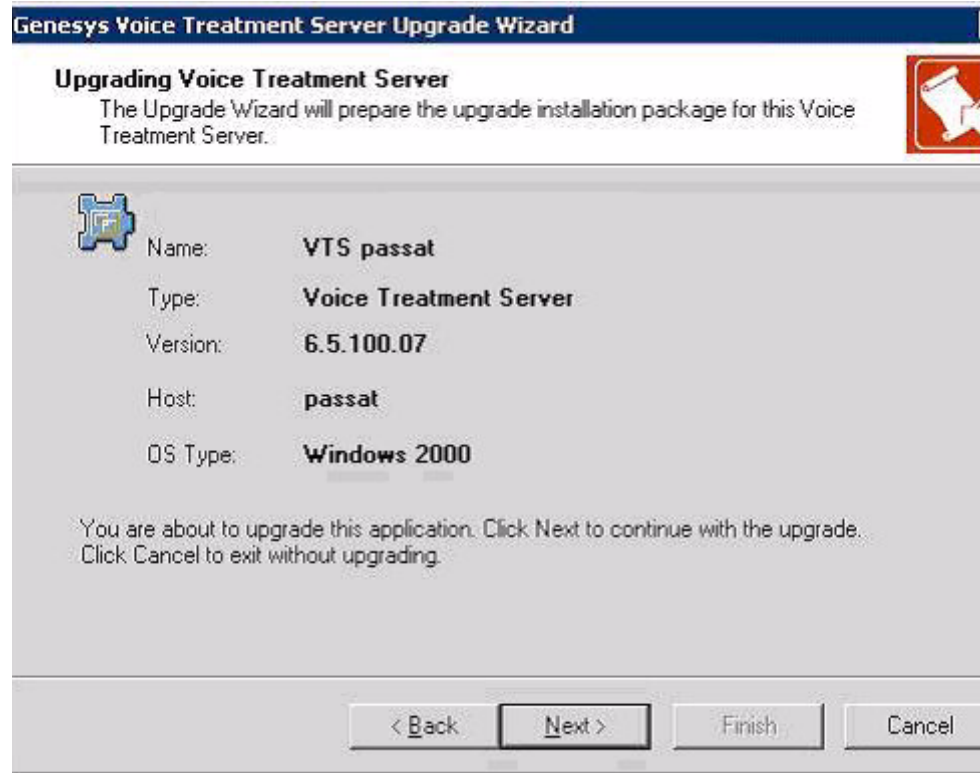

Figure 26: VT Server Upgrade Wizard—Upgrading VT Server

If you plan to move the application to another computer, you can do so using the next Wizard screen.

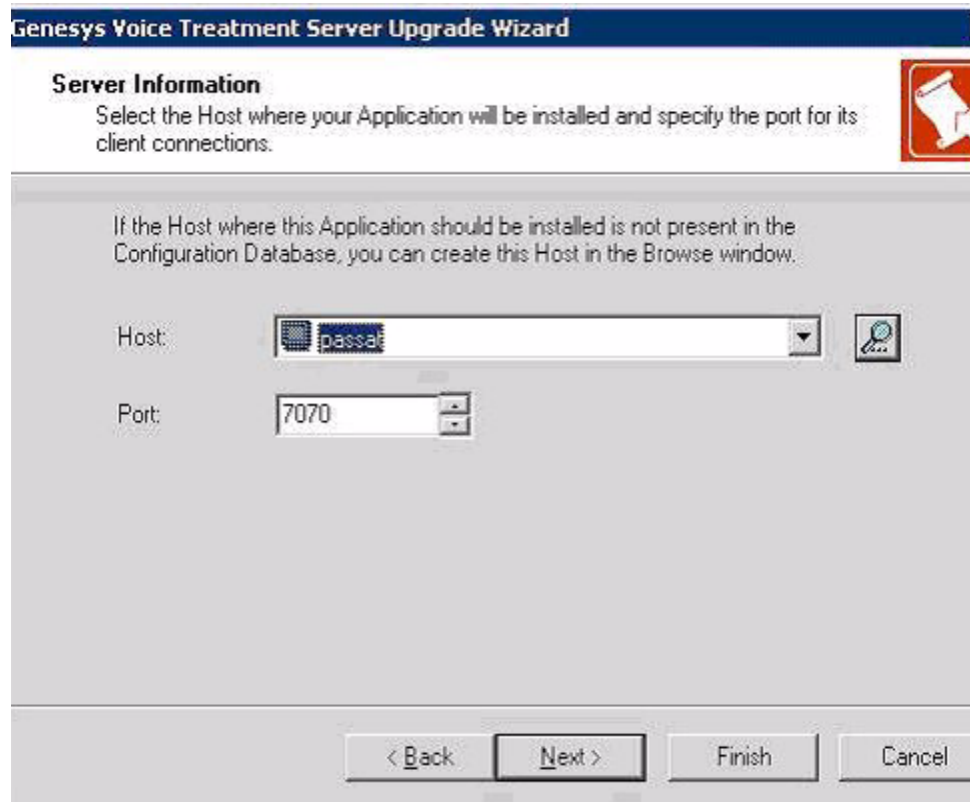

Figure 27: VT Server Upgrade Wizard—Server Information

Note: If you move VT Server from its original location, you have to make sure that its new configuration corresponds to the hardware installed on the new host. You may need to review the initial VTO deployment procedure described in Chapter 3, “Configuring and Deploying VTO” in the *Voice Treatment Option 7 Voice Treatment Server User’s Guide* and, after the upgrade procedure is complete, review and, if necessary, modify the VT Server’s configuration settings. To make sure that existing voice recordings are correctly relocated, carefully follow the instructions given in the “Recording location” section.

The next Wizard window prompts you for the source of the new VT Server Installation Package and the network location to which the Installation Package appropriate for the operating system of the target host will be copied.

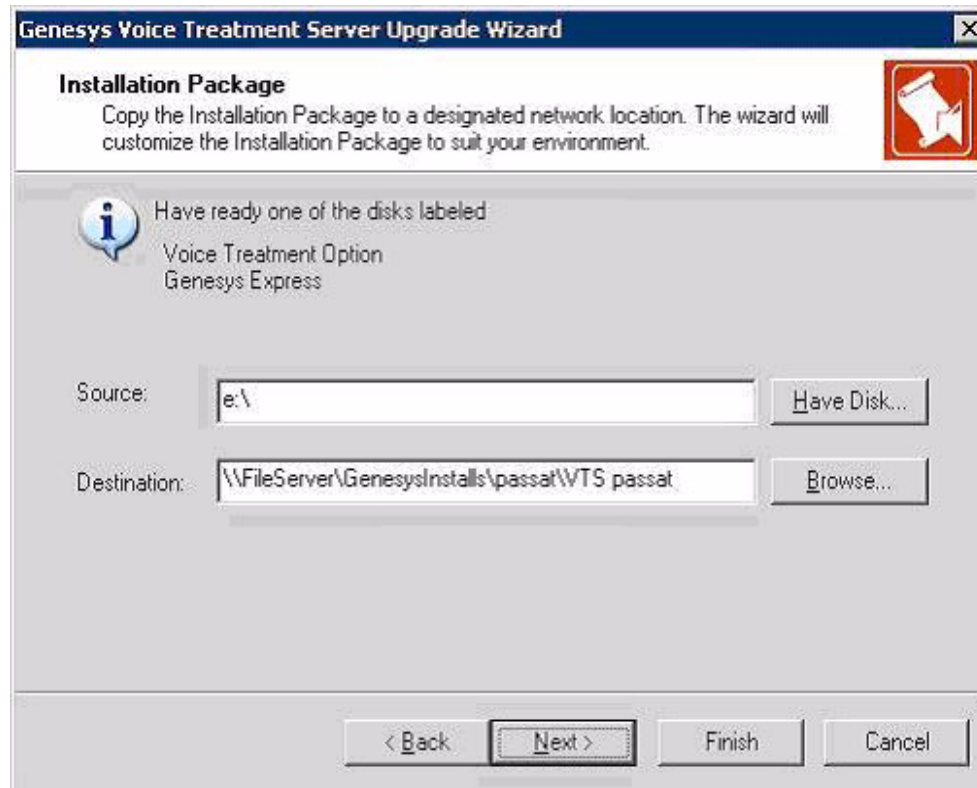

Figure 28: VT Server Upgrade Wizard - Installation Package

2. Select the Source containing the VTO Product DVD image. This may be the DVD drive containing the VTO Product DVD or the network directory containing the VTO DVD image. Point to the Destination where the Wizard will place VT Server's Installation Package. The selected destination must be writable from your computer and can be read from the host where you plan to install VT Server.
3. When you click Next, the Wizard copies the VT Server Installation package from the Product DVD to the Destination you specified.

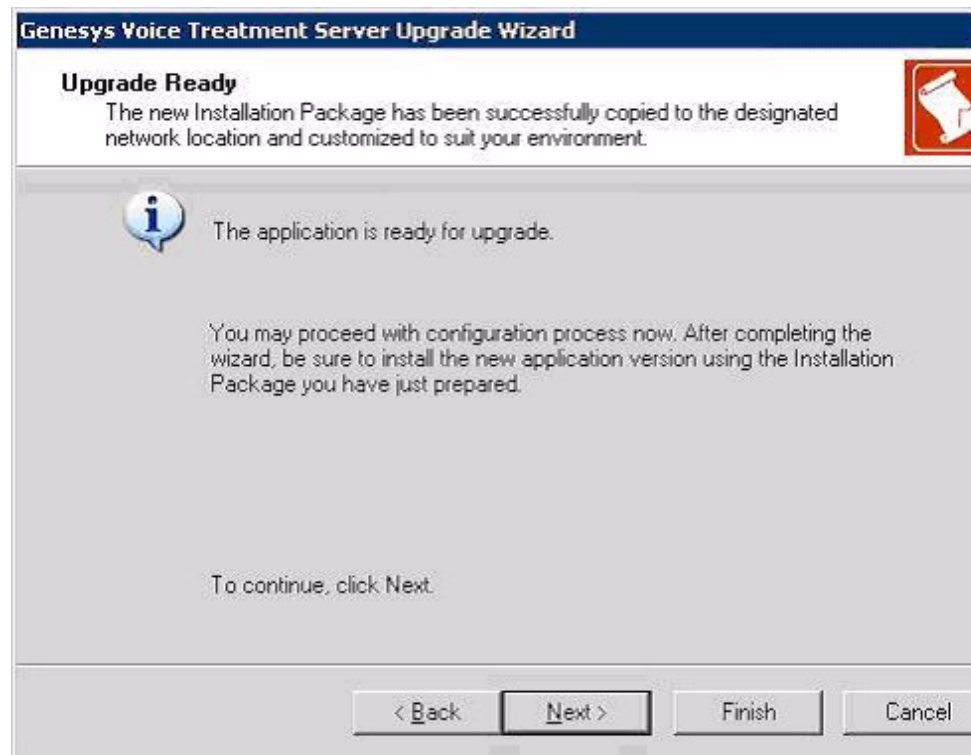

Figure 29: VT Server Upgrade Wizard - Upgrade Ready

Once the installation package has been copied into the Destination you just specified, you can install VT Server from this location by running Setup on the target host. Along with the installation package, the Wizard places the reference to the VT Server's application object in the configuration so that when you run the Setup on the VTO host, the Setup is able to read the configuration data from this object and put local settings at the target computer accordingly.

Note: Do not reuse the installation package copied by the Wizard for another instance of VT Server.

4. Once you have copied the Installation Package, click **Finish**. This returns you to the VT Servers list of the Voice Treatment Option Upgrade Wizard.

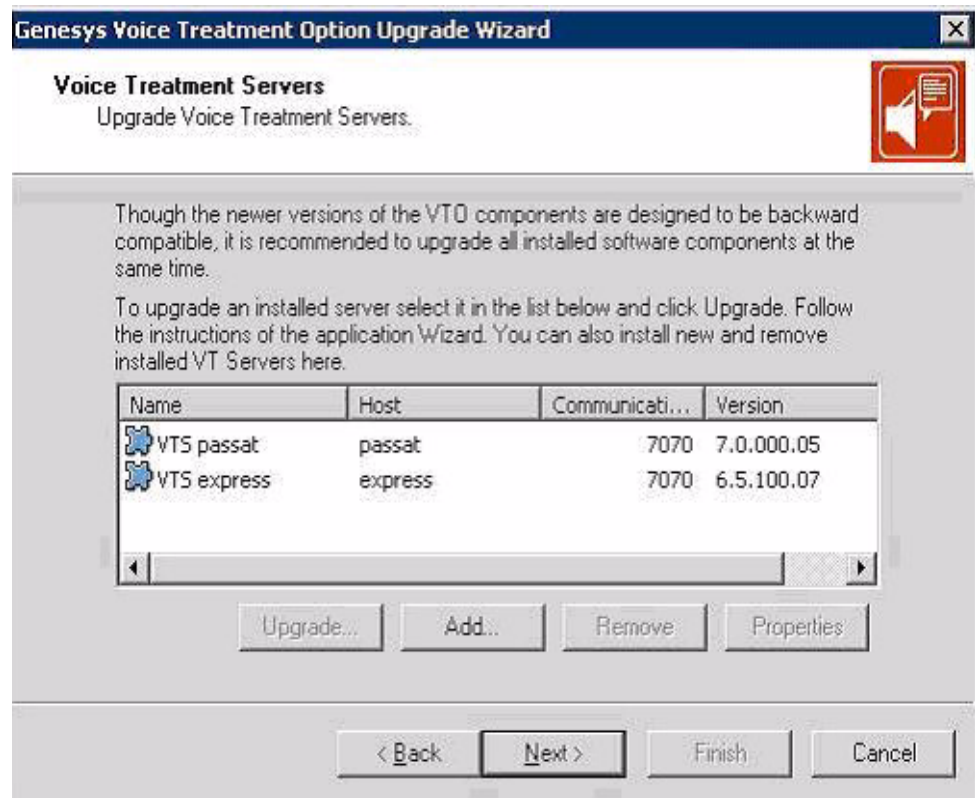

Figure 30: VTO Upgrade Wizard—VT Servers

- Continue upgrading VT Servers by selecting another outdated one in the list and click Upgrade.

Warning! If you are upgrading VT Server from 5.1.027.00 or an earlier version, you need to upgrade all VT Servers configured to serve the same Tenant at once. Running VT Servers 5.1.027.00 or earlier concurrently with any later version (5.1.028.00 and later, including 7.0) in some circumstances may cause irreversible loss of voice recordings.

Upgrading VT Manager

Once you have finished upgrading VT Servers, proceed to the next window of the VTO Configuration Wizard.

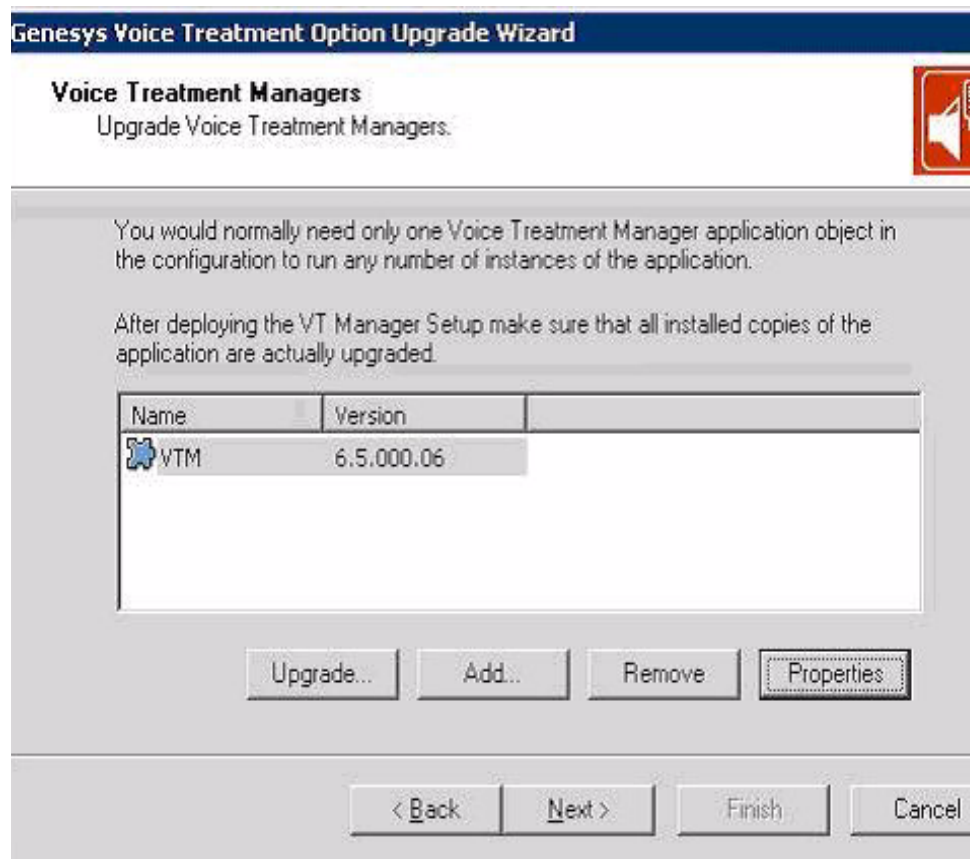

Figure 31: VTO Upgrade Wizard—VT Managers

This window allows you to launch the VT Manager Upgrade Wizard, which prepares the Installation Package for upgrading VT Managers on the client computers. The sequence of the Wizard's screens is similar to the one you have seen while upgrading VT Servers. The Upgrade Wizard updates the VT Manager application object in the configuration, and copies the Installation Package of the updated VT Manager into the network location you specify. Once the installation package has been copied, you can install VT Manager from this location by running Setup on the target computers. Unlike the VT Servers, the single instance of the Installation Package copied by the Wizard can be used to upgrade all VT Managers installed on the client computers.

Enabling VTO administrative functions in VT Manager

Some VTO administrative functions introduced in VT Manager 7.0 (i.e., VTO scripts Export/Import and Voice Files and Actions management) require the VTO Configuration Wizard to be installed along with VT Manager itself. Details about these functions can be found in Chapter 9, "VTO Export/Import

Wizards” in the *Voice Treatment Option 7 Voice Treatment Manager User’s Guide*.

If you plan to enable this functionality on computers other than the one you use for configuring, deploying and upgrading VTO, you need to provide access to the Wizard’s Installation Package from these computers. To do so, copy the Wizard’s Installation Package located in the `configuration_wizard` directory on the VTO Product DVD along with the VT Manager’s Installation Package copied by the VT Manager Upgrade Wizard. The VTO Configuration Wizard and VT Manager may be installed on the client computers in any sequence.

Note: In order for the VTO scripts `Export/Import` and `Voice Files` and `Actions` management to function in VT Manager, VT Manager requires read/write file access from the computer where VT Manager is running to the VT Server’s `Program` and `Voice` directories. The `Program` directory is the directory where the VT Server’s Setup installs VT Server. It can be identified by the presence of the main VT Server executable module named `EAServer.exe`. The `Voice` directory is the one where VT Server keeps its voice recording files. Its default location is the `VoiceData` subdirectory of the VT Server program directory. Its location is specified by the `General\VoiceDir` option in the VT Server’s application configuration object (refer to the “Recordings Location” section in the *Voice Treatment Option 7 Voice Treatment Server User’s Guide* for detailed information). In order to enable administrative functions in VT Manager, create a network share that allows read/write access to the VT Server’s `Program` and `Voice` directories for the Windows network users you plan to perform the VTO management functions.

If multiple VT Servers are configured to serve a single Tenant and replicate voice recordings and extension actions modules between each other, it is sufficient to open access to only one VT Server’s `Voice` and `Program` Directories to enable `Export/Import` and `Voice Files` and `Actions` management functionality in VT Manager. Files placed in the single VT Server’s directories by the `Export/Import` Wizard will be replicated to other VT Servers with the VT Server’s built-in file replication.

Note: Exception - If you have one or more VT Servers configured to serve multiple Tenants concurrently and would prefer not to allow access to the entire VT Server's Program and Voice directories to any single VT Manager user, but still want to enable VT Manager's administrative functions for each Tenant's users individually, you may want to install and configure additional VT Servers for each Tenant and have the additional VT Servers act solely as the replication agents. Such "replicated" VT Servers can be installed on any computer in the network in the Demo Mode, without depending on the Dialogic service and will not require additional licenses to run. Their Voice and Program directories can be open for access for their respective Tenant users.

Adding VTO to the Enterprise Routing Solution

To manage new VTO components through the Management Layer as solution components, you need to add VTO to the ERS.

Note: If you do not plan to manage the VTO components from within the solution, proceed to the section, "[Upgrading Individual VTO Components](#)" below.

1. On the Options tab of the Enterprise Routing Solution Properties window, select Voice Treatment Option.

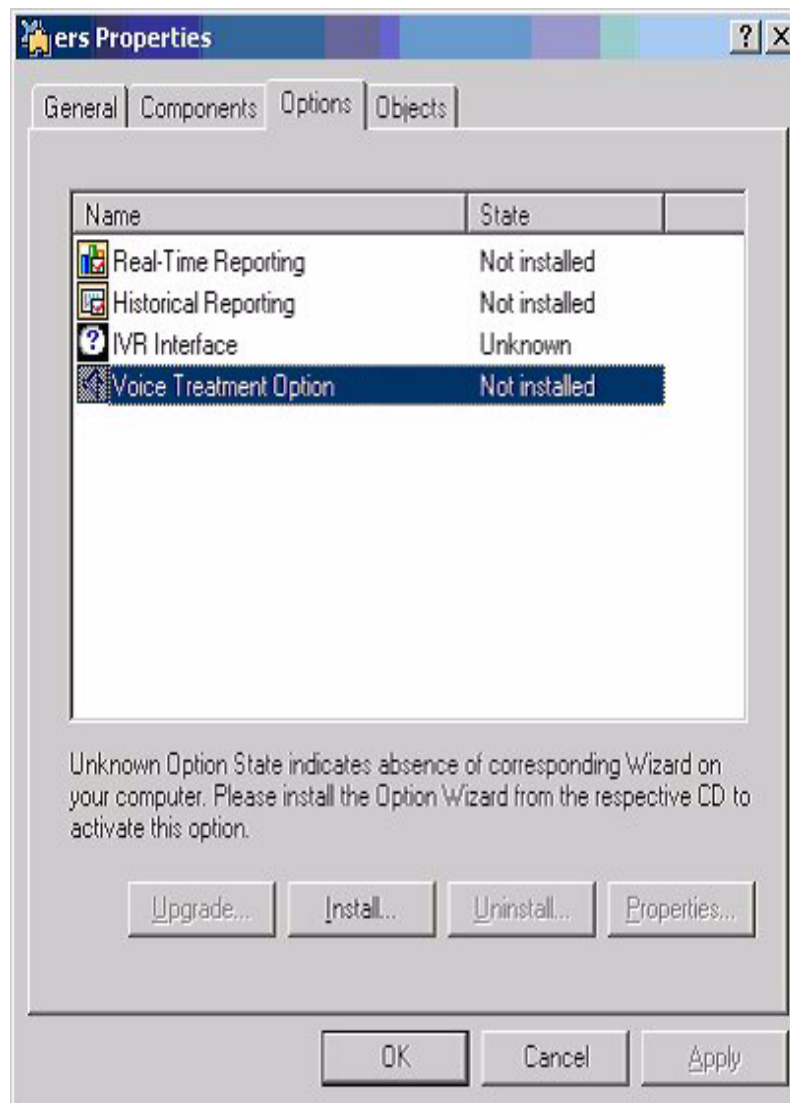

Figure 32: ERS Properties

- Since VTO is not yet installed in this solution, its State is displayed as Not Installed. Click Install. This launches the Voice Treatment Option Wizard.
- On the Voice Treatment Servers page of the Wizard, add the VT Servers you plan to run within the solution. Since you are upgrading VTO from a previous version, there are already existing Voice Treatment Server Application objects in the configuration. The Wizard allows you to add them as solution components by pressing Add, and then selecting existing Servers in the Browse window.

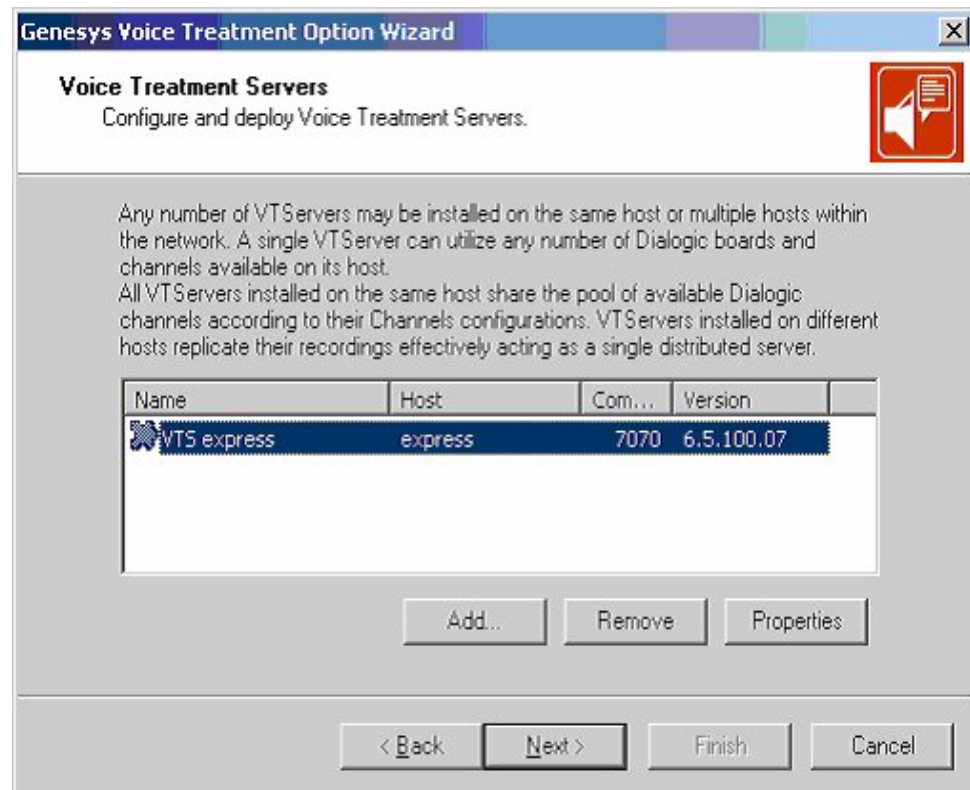

Figure 33: VTO Wizard—VT Servers

4. On the Voice Treatment Managers screen of the Wizard, add the VT Manager object that exists in your configuration.

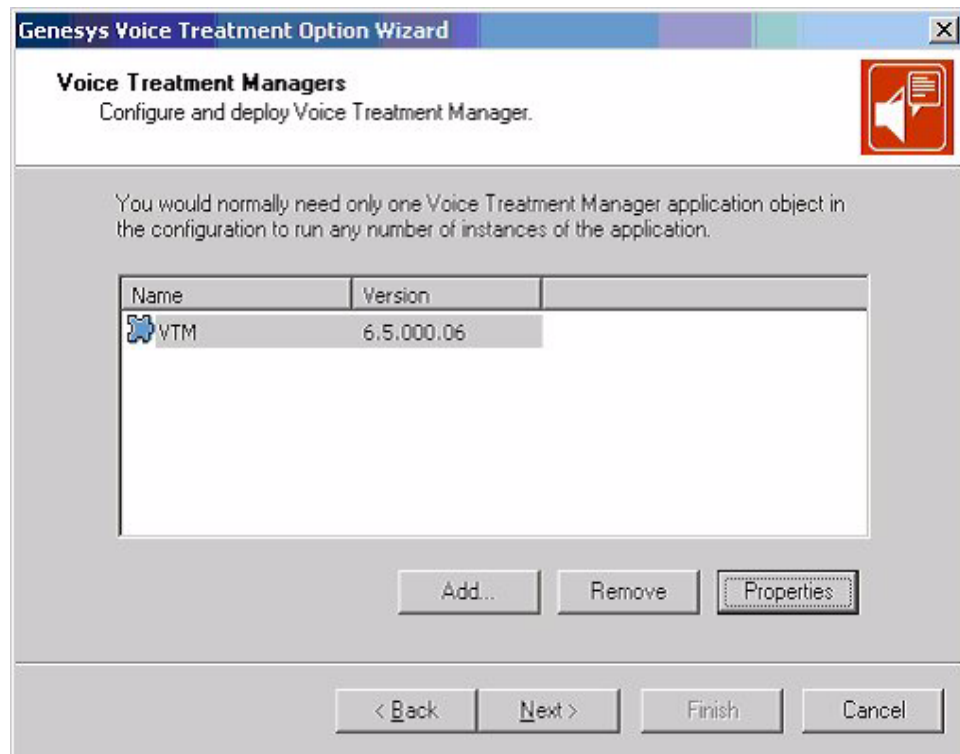

Figure 34: VTO Wizard—VT Managers

5. Clicking **Finish** returns you to the Options page of the ERS window. The state of the Voice Treatment Option is now changed to **Installed** and you may proceed with the main upgrade procedure of the VTO components as described above.

Upgrading Individual VTO Components

Genesys recommends that you keep VTO components configured within Enterprise Routing Solutions so that the entire solution can be configured with the Configuration Framework and managed with the Management Layer as a single entity. Starting with version 6.5, VTO has been specifically designed to be interoperable with the Management Layer and configured and managed as components of ERS. However, it is possible to run VTO components that are not formally included in any Solution. If you intend to continue running VTO this way, you may still upgrade the VTO components through the Wizard Manager's Upgrade screen.

1. Start the Genesys Wizard Manager.
2. Through the opening window of the Wizard, login into the configuration.

3. Select the Upgrades link on the left side of the window. The right side of the window displays the list of configured Solutions.
4. Select the Show Individual Applications checkbox. This opens the list of all applications defined in the configuration with versions lower than 7.0.

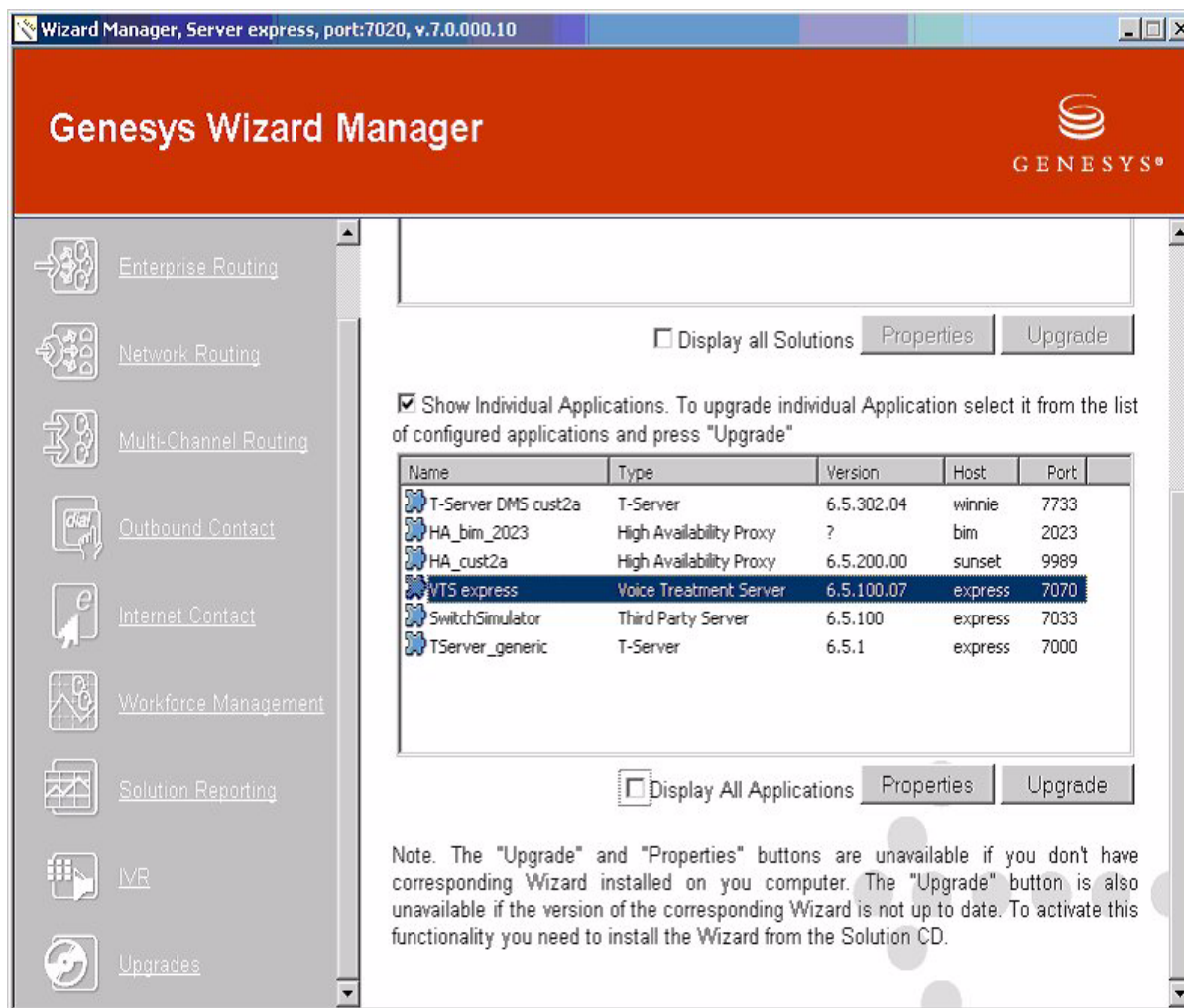

Figure 35: Genesys Wizard Manager

5. Locate the Voice Treatment Server or Voice Treatment Manager application you plan to upgrade. Click Upgrade. This launches the Upgrade Wizard for the selected application directly. Use the Upgrade Wizard as described above.

Upgrading VTO Manually

Genesys recommends that you upgrade the VTO components using VTO Configuration Wizards. Only use the manual procedure if the version of your configuration environment is earlier than 6.x.

Note: The only 7.0 VTO component capable of running in a pre-6.0 configuration environment is VT Server. VT Manager and VTO Configuration Wizard require at least Configuration Server 6.0.

To upgrade VTO manually:

1. In Configuration Manager, for each configured VT Server, open the Properties window for the VT Server Application object.
2. From the Options tab, export the configuration options to a configuration file. Save a copy of this file in case you have problems configuring VTO 7.0 and need to return to the VTO 5.1 version.
3. From the Options tab, remove the options that are no longer supported, replace the options that were replaced by others, and add new options supported in VTO 7.0. See the *Voice Treatment Option 7 Voice Treatment Server User's Guide* for more information. Also see Table 117 on [page 676](#) for options implemented between VTO 5.1 and VTO 7.0.

Table 117: VTO Options

Option	Server Name	Type of Change	Change Occurred in Release #
WaitForReleasedTimeoutMSec	VT Server	Newly implemented	7.0.1
SilenceDetectionTimeoutSec	VT Server	Newly implemented	7.0.1
AnswerTimeoutMSec	VT Server	Newly implemented	7.0.1
CallRecovery	VT Server	Newly implemented	6.5
RecoveryTransferDestination	VT Server	Newly implemented	6.5
AnswerMethod	VT Server	Newly implemented	5.1.028
WaitForEstablishedTimeout	VT Server	Newly implemented	5.1.028
Ring	VT Server	Newly implemented	5.1.027
Release	VT Server	Newly implemented	5.1.027

Table 117: VTO Options (Continued)

Option	Server Name	Type of Change	Change Occurred in Release #
NoTEventRingingTimeoutSec	VT Server	Newly implemented	5.1.027
CutCallsOnTDisconnect	VT Server	Newly implemented	5.1.023

4. Add the log section and log options to the Options tab. See *Framework 7 Configuration Manager Help* for information about adding a new section and the *Framework 7 Configuration Options Reference Manual* for a list of log options.
5. Click OK to save the changes and close the Properties window.
6. On each target host where you are upgrading VT Server, uninstall the previous version of VT Server. Before uninstalling, make note of the directory where VT Server's executables and voice recordings are located. The uninstallation will remove all program components, but will leave all voice recordings intact. From the Voice Treatment Option 7.0 DVD, launch the VT Server setup.exe located in the solution_specific\vts\windows directory. See the *Voice Treatment Option 7 Voice Treatment Server User's Guide* for installation instructions.

Note: If you are installing the new version of the VT Server in the same directory where the older version of VT Server was installed, the VoiceDir option, which specifies the path to the recordings directory, remains valid. This allows the new VT Server to use the old recordings immediately. If you are installing VT Server in a different directory and the VoiceDir option specifies the relative path (path relative to the location of VT Server's executable), you will need to *either*:—modify the VoiceDir option to make it point to the old location and move the system recordings (Sys*.VOX files and SysDigits.VOX directory) installed there by the setup files. *or*—move old recordings to the new location pointed to by the VoiceDir option.

7. On each workstation, uninstall the previous version of VT Manager. To install the new version from the Voice Treatment Option 7.0 DVD, launch the VT Manager setup.exe located in the solution_specific\vtm\windows directory. See the *Voice Treatment Option 7 Voice Treatment Manager User's Guide* for installation instructions.



Part

13 **Workforce Management Migration**

This section provides an overview of changes to Workforce Management since the 6.5.1 releases and provides migration instructions. This Part has the following chapter:

- [Chapter 42, “Workforce Management Migration Procedures,”](#) on page 681 gives an overview of changes to Workforce Management since the 6.5.1 release and provides migration instructions from WFM 6.x and 7.x to WFM 7.6.1.



Chapter

42

Workforce Management Migration Procedures

This chapter gives an overview of changes to Workforce Management since the 6.5.1 release and provides instructions for migration from WFM 6.x and updating from 7.6.0 to WFM 7.6.1.

This migration chapter assumes you have read and are thoroughly familiar with the information in Chapters 2–4 of the *Workforce Management 7.6 Administrator's Guide*. These chapters present an overview of Workforce Management 7.6 features and architecture; provide deployment-planning guidelines; and list important software prerequisites.

This chapter has these sections:

- [Migration Overview, page 682](#)
- [Prerequisites, page 683](#)
- [Deploying Workforce Management, page 684](#)
- [Migration from WFM 6.x to WFM 7.0 and to WFM 7.1, page 686](#)
- [Updating from WFM 7.x to WFM 7.6.1, page 689](#)
- [Migration from WFM 6.x to WFM 7.6.1, page 691](#)
- [Two-Step Migration, page 693](#)
- [Changes from WFM 6 to WFM 7, page 694](#)
- [Changes from WFM 7.x to WFM 7.6, page 697](#)
- [Troubleshooting, page 700](#)

Migration Overview

The most important aspect of migrating is the database migration or updating. Configuring and installing the new components is the same whether you are migrating, updating or installing for the first time. Therefore, this chapter focuses mostly on database migration and updating.

- See the *Workforce Management 7.6 Administrator's Guide* for configuration and installation procedures.

The procedures given here document only those steps that are specific to migration or updating from previous product releases.

Procedures that all users of Workforce Management 7.6 must perform are documented in the chapters “Installing and Configuring Workforce Management” and “Configuring Application Object Settings” in the *Workforce Management 7.6 Administrator's Guide*.

Note: Be sure to have the *Workforce Management 7.6 Administrator's Guide* at hand before beginning your migration or updating.

Differences—Migrating from 6.x vs. Updating from 7.x

The procedures for database update from 6.x and updating from version 7.x differ. If you are currently using WFM 7.x, you simply need to run the required database updates. However, if you are currently using WFM 6.x, you must create a new database and then migrate your existing data into it.

The architecture changed substantially between the latest 6.x release and the 7.x release. Users who are currently using WFM 6.x will have more new terminology to learn, new objects to configure, and adjustments to existing objects to perform. See “Changes from WFM 6 to WFM 7” on [page 694](#) for details.

Migration Overview—From 7.x to 7.6.1

For detailed instructions, see “Updating from WFM 7.x to WFM 7.6.1” on [page 689](#).

1. Stop your application server (Tomcat or WebSphere) and delete the existing `wfm.war` file and `wfm` directory from your application server's directory.
2. Uninstall your existing WFM components.
3. Import Application templates, create new Application objects, and then configure and install the new WFM components, as described in the *Workforce Management 7.6 Administrator's Guide*.

Note: The installation process differs from that for the previous WFM 7.x versions. Review the installation instructions thoroughly before installing.

4. Use the WFM Database Utility to run a database update that makes the necessary changes to your database to use WFM 7.6.1. See Chapter 8, “Using the WFM Database Utility,” in the *Workforce Management 7.6 Administrator’s Guide* for database update instructions.

Migration Overview —From 6.x to 7.6

This is simply an overview of the process. For detailed instructions, see “Migration from WFM 6.x to WFM 7.6.1” on [page 691](#).

1. Create a new database.
2. Import Application templates, create new Application objects, and then configure and install the new WFM components, as described in the *Workforce Management 7.6 Administrator’s Guide*.

Note: The installation process differs significantly from that for WFM 6.x. Review the installation instructions thoroughly before installing.

3. Use the WFM Database Utility to run a database update that transfers your existing data to your new 7.6.1 WFM database. See Chapter 8, “Using the WFM Database Utility,” in the *Workforce Management 7.6 Administrator’s Guide* for database update instructions.
4. Uninstall your WFM 6.x components.

Prerequisites

Check the *Genesys Supported Operating Environment* document for the supported platforms and databases, as well as the additional software required to operate WFM 7.6.1:

Genesys Framework Components

You must have deployed the following Genesys Framework components in your environment to support forecasting, scheduling, and adherence capabilities:

- DB Server
- Configuration Server
- Configuration Manager

- T-Server
- Stat Server

Framework Version

For full interoperability with Workforce Management 7.6.1, the Genesys Framework components must be version 7.x or higher. Using Workforce Management 7.6.1 with earlier versions of these components (6.5.1 and higher) limits use of the Configuration Wizards, Management Layer support, and Reason Code support.

If you are using the E-mail notification feature introduced in Workforce Management 7.2, then the Genesys Framework components should be version 7.1 or higher. Earlier versions of Framework did not include an E-mail address field as part of the Person object.

Workforce Management Version

You can migrate to WFM 7.6.1 from any WFM 6 version or from any previous WFM 7.x version.

Warning!

If you are currently running a version of Workforce Management earlier than 6.5.201.00, the WFM Database Utility must change the original database structure during the migration process in such a way that you can no longer use your original database in your existing environment.

Genesys recommends that you back up your database before beginning your migration.

Database Sizing

Updating from WFM 7.x The required database size for WFM 7.6.1 is approximately the same as for the previous versions of WFM 7.x.

Migrating from WFM 6.x The ratio of a WFM 6.x database to a WFM 7.6 database is approximately 11:9. The WFM 7.6 database is actually smaller than the WFM 6.x database. However, you store forecast and schedule scenarios in the 7.1 database rather than in a local or network file. When you add the space required to store scenarios, the database size needed for WFM 7.6.1 comes to approximately the same size as that required for WFM 6.x.

Deploying Workforce Management

Changes from WFM 7.x WFM 7.6 deployment—that is, configuration and installation of the components—is essentially the same as for version 7.2. Note that beginning

with version 7.2, WFM Reports Server is no longer a separate installation package. See “Updating from WFM 7.x to WFM 7.6.1” on [page 689](#) for a description of all 7.x changes.

**Changes from
WFM 6.x**

If you are currently running WFM 6.x, deploying Workforce Management 7.6 differs from your current version in two major respects:

- The installation of WFM components is now performed using separate installation packages rather than a single one.
- The increased capabilities of the WFM Web component eliminate the need to deploy a Windows-based client for many current WFM users. The majority of WFM users, with the exception of those who need to configure the WFM system and its working rules, use the browser-based WFM Web only.

When your database objects are migrated to WFM 7, some terms are changed. See Table 118 on [page 695](#) for a list of these changes.

Note: Forecast and schedule files located on client workstations are no longer available after migration.

To save these files, publish the forecasts and schedules you want to keep before beginning your migration. Published schedules and forecasts, which are saved to the database, are migrated with the rest of the data.

For the step-by-step installation and configuration procedures, see Chapters 5 and 6 of the *Workforce Management 7.6 Administrator's Guide*.

Migration from WFM 6.x to WFM 7.0 and to WFM 7.1

If you are running WFM 6.x, perform the following procedure to migrate to WFM 7.0, and then if necessary, on to WFM 7.1. *You cannot migrate your data directly from a WFM 6.x database to a WFM 7.1 database.* Your path must be:

1. Migrate to a WFM 7.0 database.
2. Update your new 7.0 database to version 7.1, if necessary.

Migration Warnings

Down Time

A period of down-time is inevitably associated with the database update. This down-time could be substantial (up to 1 day), depending on the amount of data are migrating. You must take this into account when scheduling your database update.

If you are migrating a large data set, see Chapter 42, “Large Data Set Migration,” on [page 688](#). Consult with Genesys Professional Services or Genesys Technical Support if you need recommendations for how best to plan this in your environment. Existing data will be migrated into it.

Backup Your Database First

Genesys recommends that you back up your database before beginning your update.

If you are currently running a version of WFM earlier than 6.5.201.00, the WFM Database Utility automatically updates your existing database to v. 6.5.201.00 while migrating your data to the 7.6 database. Doing so changes the original database structure in such a way that you can no longer use your original database in your existing environment.

If you have Workforce Management 6.x, the WFM Database Utility automatically performs the additional upgrades required before your data can be transferred to the new Workforce Management 7 Database.

Migrate WFM 6.x to WFM 7.0

1. Create a new database. This will be your WFM 7.1 database. All your existing data will be migrated into it.
2. Review the list of prerequisites in Chapter 42, “Prerequisites,” on [page 683](#) and in the *Genesys Supported Operating Environment* document and install any necessary software.

3. Create a Database Access Point (DAP) for your new database.
4. Import the Workforce Management Application templates. Then run the WFM Configuration Wizards to create an Application object for each Workforce Management component and prepare them for use. Or, if you prefer, you can manually create and configure the component Application objects using Configuration Manager.
 - Configuration instructions are located in Chapter 5 of the *Workforce Management 7.1 Administrator's Guide*.
 - Some notes describing how Workforce Management 7.1 deployment differs from that for previous releases appear in Chapter 42, "Deploying Workforce Management," on [page 684](#).
5. Install all Workforce Management components from your software DVD. Installation instructions are located in Chapter 5 of the *Workforce Management 7.1 Administrator's Guide*.

Note: You need to install only the WFM Database Utility in order to perform the data transfer from your previous database to the new one. However, if you install all components now, you can start them as soon as your database migration is complete.

6. Locate the WFM.war file and move it to your Tomcat or WebSphere directory, as appropriate. Perform any other Tomcat-specific or WebSphere-specific configuration as detailed in Chapter 5 of the *Workforce Management 7.1 Administrator's Guide*.
7. Stop all Workforce Management 6.x components, except Data Aggregator, including all Windows-based and web clients. This ensures that no changes are introduced into the 6.x database during migration.
8. Start the WFM Database Utility.
9. Select the Database Migration option.
10. Follow the steps presented in the Database Migration Wizard that opens. The WFM Database Utility creates and formats your new database, setting up the necessary tables, views, indexes, and so on.

Note: If you are migrating from WFM 6.x and are using an Oracle database, make sure that the user who performs the migration has system privileges to create objects in the tablespace.

The Database Utility prompts you to specify your WFM 6.x Workforce Manager client application. This identifies the source 6.x WFM database. To connect to the 6.x data source, the computer on which the WFM Database Utility is running must have the appropriate data source name (DSN) configured, as specified in the Workforce Management 6.x Workforce Manager Application object.

The WFM Database Utility then copies your data from the source WFM 6.x database to the newly created WFM 7.0 database.

Warning! Depending on the size of your database, this may require a considerable period of time, up to 1 day for particularly large quantities of data.

11. Your migration to WFM 7.0 is complete. If that was your goal, you can omit the next two steps (in the section Chapter 42, “Update WFM 7.0. to WFM 7.1,” on [page 688](#)), and start your Workforce Management 7.0 components.

If your goal was to migrate to WFM 7.1, continue.

Update WFM 7.0. to WFM 7.1

12. After you have transferred all data to your WFM 7.0 database, run a database update using the WFM Database Utility to update your database from WFM 7.0 to WFM 7.1.

Warning! You cannot migrate any 6.x data into a 7.1 database. Once your database is updated to version 7.1, you cannot add any data collected in your 6.x database. Be sure that your data is completely migrated to your 7.0 database before you update your database to version 7.1.

13. Your migration to WFM 7.1 is complete. You can now start your Workforce Management 7.1 components.

Rollback Instructions

If you need to return to the original 6.x version of WFM:

1. Uninstall the WFM 7.1 (or WFM 7.0) component.
2. If you uninstalled your WFM 6.x components, reinstall them.
3. Restore the data from your backed-up 6.x database into an empty database.

Large Data Set Migration

If you have a large data set to migrate from WFM 6.x to WFM 7.0 (or 7.1), you may choose to do a two-step migration.

During a two-step migration WFM Data Aggregator continues to run, collecting performance data for the migration period. This performance data is then transferred into the 7.0/7.1 database during a second migration. This second migration takes a relatively brief time. This procedure results in a minimal amount of uncollected data.

Warning! If you collect performance data from your 7.0/7.1 WFM Data Aggregator before migrating the performance data collected by your 6.x Data Aggregator, the 6.x performance data overwrites the 7.0/7.1 data for the same period.

To perform a two-step migration:

1. Create the `ALLOWMigratePerformance` option. See the section on setting options for the WFM Configuration Utility in Chapter 6, “Configuring Application Options Tab Settings,” in the *Workforce Management 7.1 Administrator’s Guide* for this procedure. (The WFM Database Utility uses the same application object as the WFM Configuration Utility.)
2. Set the `ALLOWMigratePerformance` option value to 1.
3. Shut down all components except for Data Aggregator.
4. Perform the database migration as described in “Migrate WFM 6.x to WFM 7.0” on [page 686](#) and the database update described in “Update WFM 7.0. to WFM 7.1” on [page 688](#).
5. Start your 7.0/7.1 WFM Data Aggregator. This ensures that new performance data from the time it takes to perform the performance data migration is captured and written to the 7.0/7.1 database.
6. Select the `Migrate Performance Data` option in the WFM Database Utility and follow the instructions on the wizard screens to perform the migration.

Updating from WFM 7.x to WFM 7.6.1

If you are currently running WFM 7.x:

1. Back up your WFM 7.x database.
2. Start DB Server and Configuration Server.
3. Stop your servlet runner (WebSphere or Tomcat).
4. Delete both the `wfm.war` file and the `wfm` directory from the servlet runner directory in which you placed them when you installed WFM 7.x.
The Workforce Management 7.6 Administrator’s Guide has instructions for where to place the `wfm.war` file if you are using Tomcat. If you are using WebSphere, consult your WebSphere documentation for the correct directory.
5. Uninstall your WFM 7.x components using the Windows Add/Remove Programs function.
6. Configure and install the WFM 7.6.1 components, following the procedure given in the *Workforce Management 7.6 Administrator’s Guide*. This includes importing the latest application templates and creating new Application objects for all WFM 7.6.1 components.

7. Locate the WFM 7.6.1 version of the `wfm.war` file. The default installation directory is
`<Drive Letter>:\Program Files\GCTI\WFM76\Web\WFM_Web_76.`
 You can verify that you have found the 7.6 version of the `wfm.war` file by checking the version number in the `ip_description.xml` file, located in the same directory.
 8. Copy the `wfm.war` file and paste it into the appropriate directory for your servlet runner.
 9. Restart your servlet runner. Wait a minute or so and then open the directory in which you placed the `wfm.war` file. You should now see a new folder that called `wfm`.
 10. Start the WFM Database Utility. You can start it by selecting it from Start > Programs > Genesys Solutions > Workforce Management 7.6.
 11. Select the radio button for Database Update and then follow the instructions on the wizard screens that open. This updates your WFM database to the latest schema. All of your existing data is preserved.
 12. Start all components and verify that all are working correctly.
- Your migration is complete.

Rollback Instructions

If, for some reason, you need to roll back your installation to version 7.x:

1. Uninstall the WFM 7.6.1 components.
2. Reinstall the WFM 7.x components.
3. Restore the data from your backed-up 7.x database into an empty database.

Verify Your Connections

If you experience any connectivity issues immediately after migration:

- Check the Details sections of each Login screen to verify that your applications are pointing to the correct WFM Application objects.
- Verify that you have the correct connections specified on the Connections tabs of the Application objects for each component.
- In WFM Configuration Utility's Organization module, update:
 - Data Aggregator Name for each Business Unit object
 - Data Aggregator Name for each Site object
 - Data Aggregator for synchronization for each Site object
 - WFM Server for each Site object
- In WFM Configuration Utility's User Security module, update:
 - WFM Builder object for each user

Migration from WFM 6.x to WFM 7.6.1

If you are running WFM 6.x, you must execute the following procedure to perform your migration.

Migration Warnings

Down Time

A period of down-time is inevitably associated with the database migration. This down-time could be substantial (up to 1 day), depending on the amount of data are migrating. You must take this into account when scheduling your database migration.

If you are migrating a large quantity of data, see “Two-Step Migration” on [page 693](#). Consult with Genesys Professional Services or Genesys Technical Support if you need recommendations for how best to plan this in your environment.

Existing data will be migrated into it.

Backup Your Database First

Genesys recommends that you back up your database before beginning your migration.

If you are currently running a version of WFM earlier than 6.5.201.00, the WFM Database Utility automatically upgrades your existing database to v. 6.5.201.00 while migrating your data to the 7.6 database. Doing so changes the original database structure in such a way that you can no longer use your original database in your existing environment.

Migrate WFM 6.x to WFM 7.6.1

1. Create a new database. This will be your WFM 7.6.1 database. All your existing data will be migrated into it.
2. Review the list of prerequisites in “Prerequisites” on [page 683](#) and in the *Genesys Supported Operating Environment* document and install any necessary software.
3. Create a Database Access Point (DAP) for your new database.

4. Import the Workforce Management Application templates. Then run the WFM Configuration Wizards to create an Application object for each Workforce Management component and prepare them for use. Or, if you prefer, you can manually create and configure the component Application objects using Configuration Manager.
 - Configuration instructions are located in Chapter 5 of the *Workforce Management 7.6 Administrator's Guide*.
 - Some notes describing how WFM 7.6.1 deployment differs from that for previous releases appear in “Deploying Workforce Management” on [page 684](#).
5. Install all WFM components from your software DVD. Installation instructions are located in Chapter 5 of the *Workforce Management 7.6 Administrator's Guide*.

Note: You need to install only the WFM Database Utility in order to perform the data transfer from your previous database to the new one. However, if you install all components now, you can start them as soon as your database migration is complete.

6. Locate the WFM.war file and move it to your Tomcat or WebSphere directory, as appropriate. Perform any other Tomcat-specific or WebSphere-specific configuration as detailed in Chapter 5 of the *Workforce Management 7.6 Administrator's Guide*.
7. Stop all WFM 6.x components, except WFM Data Aggregator, including all Windows-based and web clients. This ensures that no changes are introduced into the 6.x database during migration.
8. Start the WFM Database Utility.
9. Select the Database Migration option.
10. Follow the steps presented in the Database Migration Wizard that opens. The WFM Database Utility creates and formats your new database, setting up the necessary tables, views, indexes, and so on.

Note: If you are migrating from WFM 6.x and are using an Oracle database, make sure that the user who performs the migration has system privileges to create objects in the tablespace.

The WFM Database Utility prompts you to specify your WFM 6.x Workforce Manager client application. This identifies the source 6.x WFM database. To connect to the 6.x data source, the computer on which the WFM Database Utility is running must have the appropriate data source name (DSN) configured, as specified in the Workforce Management 6.x Workforce Manager Application object.

The WFM Database Utility then copies your data from the source WFM 6.x database to the newly created WFM 7.6.1 database.

Warning! Depending on the size of your database, this may require a considerable period of time, up to 1 day for particularly large quantities of data.

11. Your migration should now be complete. You can now start your Workforce Management 7.6.1 components.

Rollback Instructions

If you need to return to the original 6.x version of WFM:

1. Uninstall the WFM 7.6.1 components.
2. If you uninstalled your WFM 6.x components, reinstall them.
3. Restore the data from your backed-up 6.x database into an empty database.

Verify Your Connections

If you experience any connectivity issues immediately after migration:

- Check the Details sections of each Login screen to verify that your applications are pointing to the correct WFM Application objects.
- Verify that you have the correct connections specified on the Connections tabs of the Application objects for each component.
- In WFM Configuration Utility's Organization module, update:
 - Data Aggregator Name for each Business Unit object
 - Data Aggregator Name for each Site object
 - Data Aggregator for synchronization for each Site object
 - WFM Server for each Site object
- In WFM Configuration Utility's User Security module, update:
 - WFM Builder object for each user

Two-Step Migration

If you have a large quantity of data to migrate from WFM 6.x to WFM 7.6.1, you may choose to do a two-step migration.

During a two-step migration WFM Data Aggregator continues to run, collecting performance data for the migration period. This performance data is then transferred into the 7.6.1 database during a second migration. This second migration takes a relatively brief time. This procedure results in a minimal amount of uncollected data.

Warning! If you collect performance data from your 7.6.1 WFM Data Aggregator before migrating the performance data collected by

your 6.x Data Aggregator, the 6.x performance data overwrites the 7.6.1 data for the same period.

To perform a two-step migration:

1. Create the `AllowMigratePerformance` option. See the section on setting options for the WFM Configuration Utility in Chapter 6, “Configuring Application Options Tab Settings,” in the *Workforce Management 7.6 Administrator’s Guide* for this procedure. (The WFM Database Utility uses the same application object as the WFM Configuration Utility.)
2. Set the `AllowMigratePerformance` option value to 1.
3. Shut down all components except for Data Aggregator.
4. Perform the database migration as described in “Migration from WFM 6.x to WFM 7.6.1” on [page 691](#).
5. Start your 7.6.1 WFM Data Aggregator. This ensures that new performance data from the time it takes to perform the performance data migration is captured and written to the 7.6.1 database.
6. Select the `Migrate Performance Data` option in the WFM Database Utility and follow the instructions on the wizard screens to perform the migration.

Changes from WFM 6 to WFM 7

During the database-migration process, some existing 6.x objects are renamed to be compatible with the new Workforce Management 7.x vocabulary. These changes are:

- Virtual PABXs become Business Units.
- Exclusivity Sets become Activity Sets.
- Employment Types become Contracts.
- Virtual Activities become Multi-Site Activities.
- Rotating Schedules become Rotating Patterns and the Weekly Schedules upon which they are built are now Weekly Patterns.

New 7.x Terminology

WFM 7.1.2 (the version previous to 7.2) introduced several new terms and made some changes to existing configuration objects. See Table 119 on [page 699](#) for a list of changes from 7.1.0/7.1.1 to 7.1.2.

These tables provide only basic information about the changes. For detailed explanations of these, and all WFM objects, see the “Overview” and

“Deployment Planning” chapters of the *Workforce Management 7.2 Administrator’s Guide*.

Table 118: Terminology Changes from 6.x to 7.x

Previous Term	Current Term
Virtual PABX	Business Unit
PABX, PBX, switch, location	Site
Exclusivity Sets	Activity Sets
Compliance Rules	Adherence Rules
PABX Time Offset Information	Daylight Saving Time Information
Activity	Activity
Virtual Activity	Multi-Site Activity
Activity Type	Activity Type
Scheduled Agent’s State	Schedule State Group
Aux Code	Reason
Genesys Events	Agent State
Agent	Agent
Supervisor	Supervisor
Supervisor [in security configuration]	User, WFM User
Definitions Report	Properties Report
Activity Type: Phone Activity	Immediate Work
Activity Type: Multimedia Activity	Deferred Work
Activity Type: Exclusive Activity	Fixed-Staff Work
Workforce	Staffing
Vacation Planner [limits]	Vacation Day Limits
Time Information, Open Hours	Hours of Operation
Long Period	Schedule Planning Period
Meal, Break	Meal, Break

Table 118: Terminology Changes from 6.x to 7.x (Continued)

Previous Term	Current Term
Employment Type	Contract
Shift	Shift
Working Hours	Paid Hours
Unpaid Time	Unpaid Hours
Total Hours	Total Hours (Paid Hours + Unpaid Hours)
[none]	Task
[none]	Task Sequence
Team	Team
CTI System Information	Agent Information
Employee Information	Agent Information
Carried Hours	Hours Carried Over or Carried Over Hours
Planner	Calendar
Meetings, Meeting Planner	Meetings, Meeting Planner
[none]	Calendar Item
Service Level Objectives	Service Level Objectives
Adherence (module name)	Performance (module name)
Agent Compliance	Agent Adherence
Real-Time Adherence	Real-Time Agent Adherence
Agents Logged In	Staffing
Current Status	Current State
Time in Noncompliance	Duration of Nonadherence
Compliance	Adherence
Print	Report

Changes from WFM 7.x to WFM 7.6

New in WFM 7.6.1

The components and objects used in WFM 7.6.1 are the same as those used in WFM 7.6.0, with the following new options:

- WFM Server/DetermineFullDayTimeOffStartEndPaidHours
- WFM Web/AccessLevel
- WFM Web/CommitAgentInsertedExceptions
- WFM Web/PathToAutoGeneratedReports

What Was New in WFM 7.6

The components and objects used in WFM 7.6 are the same as those used in WFM 7.5, with the following new options:

- WFM Server/Client Section/SplitCoverage
- WFM Server/Client Section/SplitMode
- WFM Server/Client Section/SplitMS
- WFM Server/Client Section/CfgServerRequestTimeout
- WFM Server/ForecastService Section/ForecastTimestep
- WFM Server/ScheduleService Section/AutoCleanupTimeout
- WFM Client/Options Section/KeepBonusHours
- WFM Client/Client Section/CfgServerRequestTimeout
- WFM Web/AgentTimeOff Section/AllowEnterPaidTime
- WFM Web/AgentTimeOff Section/AllowWaitList

What was New in WFM 7.5

The components and objects used in WFM 7.5 are the same as those used in WFM 7.2 with the following new options:

- WFM Server/ForecastService Section: ForecastTimestep
- WFM Server/ScheduleService Section: AutoCleanupTimeout
- WFM Client/Client Section: CfgServerRequestTimeout
- WFM Web/AgentBidding Section: AllowBidding
- WFM Web/AgentPreferences Section: AllowPreferences
- WFM Web/AgentTimeOff Section: AllowTimeOffPlanner
- WFM Web/Options Section: NoPerformanceInSchedule
- WFM Web/Reports Section: ShowActualHeadcount

See the “Configuring the Options Tabs” chapter in the *Workforce Management 7.6 Administrator’s Guide* for descriptions of all 7.6 configuration options.

What Was New in WFM 7.2

The components and objects used in WFM 7.2 are the same as those used in WFM 7.x with the following exceptions:

- Starting with WFM 7.2, there is no longer a separate WFM Reports component for building reports. The report-generating functionality is now integrated into the WFM Web component.
- A new WFM Daemon (background process) can be configured to send (through a customer-supplied SMTP server) e-mail notifications to agents based on schedule modifications, and to agents and supervisors for schedule trade request status updates and time off request status updates

For more information on both changes, see the *Workforce Management 7.2 Administrator’s Guide*.

However, in addition to the new features described in Chapter 2, “Overview” of the *Workforce Management 7.2 Administrator’s Guide*, there are some other differences from 7.x.

- A few configuration options have been removed, several have been added, and the default settings for some others have been changed. [Table 119](#) shows these changes.

What Was New in WFM 7.1.2

The WFM 7.1.2 version introduced several new terms and makes some changes to existing configuration objects. See [Table 119 on page 699](#) for a list of changes from 7.1.0/7.1.1 to 7.1.2.

[Table 119](#) explains some new objects added in the previous 7.1.2 release and some changes to already-existing objects that should be noted when migrating from an earlier release.

For more complete descriptions of these new objects and how to use them, see the *WFM 7.2 Configuration Utility Help* (for time-off rules, time-off types, and marked time) and the *WFM 7.2 Web for Supervisors Help* (for time-off limits and pending schedule changes).

Table 119: Changes in Terms and Configuration Objects from 7.1.0/7.1.1 to 7.2

Previous Term	New Term
Vacation	Time Off Type—You can now configure multiple time-off types. Each can be associated with a different time-off rule. The formerly-used <code>Vacat i on</code> object is transferred to WFM 7.1.2 as a default time-off type, called <code><vacat i on></code> .
Accrual Rule	Time-Off Rule—You can now configure different time-off rules for your various time-off types.
Vacation Limit	<p>Time-Off Limit—You can configure one set of time-off limits for all your time-off types. The granularity of time-off limits has been increased so that you can set different limits for each timestep throughout the day.</p> <p>Note: Time-off limits are configured in the WFM Web for Supervisors Calendar module.</p>
n/a	Marked Time—You can configure marked-time types that enable you to identify specific periods during the schedule that are not otherwise singled out. Two new reports enable you to report on marked-time periods.
n/a	<p>Pending Schedule Changes—The User Security module in the WFM Configuration Utility now enables you to set more precise security permissions. One such permission, Approve Changes, is required for a user to make permanent changes to the Master Schedule.</p> <p>If a user does not have this permission, changes he or she makes to the Master Schedule are entered as <i>pending</i> and must be approved by an authorized user before they can be incorporated into the official Master Schedule.</p> <p>You can also enter pending schedule changes into a schedule scenario, enabling you to review them before committing them to be incorporated or rolling them back (discarding them). These pending changes are only visible to the person who entered them. They are not included if the schedule scenario is published to the Master Schedule before they are committed.</p>

Note: No table exists for the changes between 6.x and 7.x because all components except WFM Data Aggregator are new to 7.x. See the “Configuring the Options Tabs” chapter in the *Workforce Management 7.1 Administrator’s Guide* for descriptions of all 7.1 configuration options.

Troubleshooting

If you have problems with your migration, check that you have followed all procedures correctly and that all components are running and connected. In addition, you might encounter the issues described in the following sections. If you experience other difficulties, contact Genesys Technical Support.

Install the Microsoft ODBC Data Source

You may need to install the ODBC drivers before you can migrate your 6.x database because 6.x used the DSN and ODBC drivers. They are required to connect to the 6.x database. To install the ODBC drivers, follow the instructions below.

Install the ODBC Drivers

To install the Microsoft ODBC drivers, first run the Microsoft Data Access (MDAC_Typ) program. Install both MDAC version 2.7 SP 1 or MDAC 2.8 and Jet version 4.0.

You can download MDAC 2.7 SP 1 or MDAC 2.8 from Downloads on the Microsoft website at <http://www.microsoft.com>. Follow the download and installation instructions given on the website.

When you have finished installing MDAC and Jet, reboot your system.

Select the ODBC Data Source

After installing MDAC and Jet, select and install the correct ODBC data source for your server. To do this:

1. After rebooting, select Start > Control Panel.
2. Select either ODBC Data Sources or 32-bit ODBC, whichever appears in the Control Panel.
The ODBC Data Source Administrator dialog box appears.
3. Select the System DSN tab.
4. Click Add.

The Create New Data Source dialog box appears.

5. Select the correct ODBC driver for your server.
 - If you are using Oracle, select Microsoft ODBC for Oracle driver.
 - If you are using Microsoft SQL, select SQL Server.
6. Click Finish.

The Microsoft ODBC Setup dialog box appears.
7. Specify the name of the data source and the server name (the alias) that was entered in the Oracle SQL*Net installation, or configure the Microsoft SQL connection properties as instructed in the Microsoft SQL Server DSN Configuration Wizard.
8. Click OK.

The selected ODBC drivers are added to the list of installed System Data Sources.
9. Click OK.
10. Use the ODBC Data Source Administrator window to verify that the ODBC drivers were installed.

Install the Microsoft .NET Framework

The Microsoft .NET Framework Version 1.1 Redistributable Package is required to run the WFM Database Utility. If it is not installed already, install it. The Redistributable Package is available as a free download from the Microsoft website.

Verify Your Connections

If you experience any connectivity issues immediately after migration:

- Check the Details sections of each Login screen to verify that your applications are pointing to the correct WFM Application objects.
- Verify that you have the correct connections specified on the Connections tabs of the Application objects for each component.
- In WFM Configuration Utility's Organization module, update:
 - Data Aggregator Name for each Business Unit object
 - Data Aggregator Name for each Site object
 - Data Aggregator for synchronization for each Site object
 - WFM Server for each Site object
- In WFM Configuration Utility's User Security module, update:
 - WFM Builder object for each user



Part

14 Interaction Concentrator Migration

Interaction Concentrator collects and stores detailed data about the interactions and resources in customer interaction networks that use Genesys Framework (contact center, enterprise-wide, or multi-enterprise telephony and computer networks). Downstream reporting systems can access Interaction Concentrator data in near real time.

The chapters in this section describe the following migration scenarios:

- Migration to Interaction Concentrator release 8.0
- Migration to Interaction Concentrator release 7.6.0 or 7.6.1
- Migration to Interaction Concentrator release 7.5

They also discuss component changes and the other Genesys software that supports and enables Interaction Concentrator 7.x and 8.0 functionality.

The information is divided into the following chapters:

- [Chapter 43, “Migration Order for Interaction Concentrator,”](#) on page 705 discusses the preliminary migration procedures and the migration order for migrating to Interaction Concentrator 7.x and 8.0.
- [Chapter 44, “Changes in Interaction Concentrator,”](#) on page 711 provides information about changes in components, configuration options, and the Interaction Database (IDB) that you need in order to upgrade Interaction Concentrator from one release to the next.
- [Chapter 45, “Migration Procedures,”](#) on page 735 presents the procedures for migrating to Interaction Concentrator 7.x and 8.0.

Note: Interaction Concentrator release 7.2.000.09 was the first release of Interaction Concentrator.

:



Chapter

43

Migration Order for Interaction Concentrator

This chapter discusses the preliminary migration procedures and the migration order to migrate to Interaction Concentrator (ICON) 7.5, 7.6, and 8.0.

There are three main sections in this chapter:

- [Preliminary Migration Procedures, page 705](#)
- [Order of Migration, page 707](#)
- [Interoperability Among Interaction Concentrator Components, page 708](#)

Preliminary Migration Procedures

Operating System and RDBMS Upgrades

Before you begin the migration, you might need to upgrade the operating system and/or relational database management system (RDBMS) for the Interaction Concentrator release to which you are migrating. To determine whether you need to upgrade your operating system or RDBMS, see the information about discontinued support in Table 120 on [page 712](#) (for migration to release 8.0) or Table 121 on [page 714](#) (for migration to release 7.5 or 7.6). For full information about the operating systems and databases that Interaction Concentrator supports, consult the *Genesys Supported Operating Environment Reference Manual*, which is available on the Genesys Technical Support website.

Note: If you need to upgrade your operating system before migrating your Genesys product, contact Professional Services.

Preliminary Genesys Product Migration Procedures

The process for migrating Interaction Concentrator includes the following preliminary procedures:

1. Review “Migration Roadmap,” Chapter 1 of this guide.

2. Examine the order in which you should upgrade the Genesys software that is required for the Interaction Concentrator release to which you are migrating. See “Order of Migration” on [page 707](#).
3. Examine the component changes for Interaction Concentrator. See “Component Changes for Interaction Concentrator” on [page 711](#). You might also want to examine the option changes described in “Changes to Configuration Options for Interaction Concentrator” on [page 718](#).

Note: These tables discuss only those changes that directly affect the migration of this product. For complete information about “What’s New in This Release” of Interaction Concentrator and how the release functions, see the *Interaction Concentrator Deployment Guide* for the applicable release. For a complete list of documentation relevant to the migration of this product, see “Reference Materials”.

4. Review the licensing requirements to support Interaction Concentrator.

Note: Interaction Concentrator itself does not require a license. However, other components with which Interaction Concentrator interoperates do require licenses, and these might need to be migrated. See “Licensing Migration,” Chapter 2 of this guide and the product documentation for the particular component.

5. Check the interoperability of Interaction Concentrator components during the upgrade procedures. See “Interoperability Among Interaction Concentrator Components” on [page 708](#).
6. See the *Genesys Interoperability Guide* for information on the compatibility of Genesys products with various Configuration Layer Environments; Interoperability of Reporting Templates and Solutions; and *Gplus* Adapters Interoperability.
7. Review other issues pertaining to the migration of Interaction Concentrator. See “Additional Information about Migration” on [page 709](#).

Reference Materials

- *Interaction Concentrator Deployment Guide* for the release to which you are migrating
- *Interaction Concentrator User’s Guide* for the release to which you are migrating
- *Interaction Concentrator Physical Data Model* for your particular RDBMS, for the release to which you are migrating
- *Genesys Interoperability Guide*
- *Genesys Supported Operating Environment Reference Manual*

Order of Migration

This section is specific to the components (applications) that enable and support Interaction Concentrator.

Multi-Site/Single-Site and Multi-Tenant Migration

Whether you will necessarily migrate all sites or all tenants simultaneously depends on the specific Interaction Concentrator deployment.

All tenants served by a single ICON instance will be migrated simultaneously. Similarly, in a multi-site deployment, all the sites served by a single ICON instance will be migrated simultaneously. If each site or tenant is served by a separate ICON instance, each instance will be upgraded independently.

In a deployment with multiple IDBs, each will be upgraded independently.

In a multi-site deployment with multiple ICON instances, it is possible to interoperate different releases at different sites, provided that each site also has its own IDB or provided that, because of different roles, it is not necessary for the information from the separate ICONs to be merged in the centralized IDB.

In a multi-site deployment with multiple ICON instances, if the migration for all the sites is performed sequentially while all ICON processing is stopped, it does not matter in what order you upgrade the ICON instances or IDB.

However, if you plan to migrate all the sites over a period of time when you will be interoperating releases of Interaction Concentrator, ensure that the first ICON instance you migrate is the one performing the `cfg` role.

For detailed information about the upgrade steps, see “Migration Procedures” on [page 736](#).

Note: An ICON instance that has been upgraded to a later release *cannot* write data to an earlier version of IDB. Do not start any upgraded ICON instances until you have also upgraded IDB to the appropriate schema version.

Migrating from Interaction Concentrator 7.2, 7.5, or 7.6

Migrate or upgrade the application components of Interaction Concentrator, the other enabling software, and the relevant data for this Interaction Concentrator in the following order:

Note: See procedures detailing this order in Chapter 45, “Migration Procedures,” on [page 735](#).

1. Migrate Management Framework.

Note: You can migrate to the 7.5 or 7.6 Configuration Layer or Management Layer while still using 7.2 Interaction Concentrator components. Similarly, you can migrate to the 8.0 Configuration Layer or Management Layer while still using 7.x Interaction Concentrator components. If you want to change the Configuration Database before Configuration Layer migration, migrate the database, then the data, and run the Configuration Conversion Wizard.

Management Framework is the foundation for all Genesys products, solutions, and options.

For information about migrating the layers and components of Management Framework, see “Framework Migration” in this guide.

2. Upgrade other prerequisite Genesys components (for example, T-Server or Interaction Server), as applicable for your deployment.

For information about the minimum releases of products that are required for full Interaction Concentrator release 7.x or 8.0 functionality, see the chapter about deployment planning in the *Interaction Concentrator Deployment Guide* for the applicable release.

When upgrading many components, determine if the first component you upgrade to release 7.x or 8.0 is backward compatible with the 6.x and 7.x components that have not been upgraded yet. See “Interoperability Among Interaction Concentrator Components” on [page 708](#).

3. Update the contact center configuration (for example, Place Groups, Agent Groups, and DNs).
4. Migrate Interaction Concentrator. For full details, see Chapter 45, “Migration Procedures,” on [page 735](#).
5. Migrate routing strategies.
6. Migrate Agent Desktop.

Interoperability Among Interaction Concentrator Components

The term *interoperable* means that different versions of Genesys solutions, components, or options can work together compatibly during the migration process.

Interoperability of Genesys products can occur at two levels of migration:

- **Interoperability at the suite level** means combining different versions of solutions and options during the migration process.

- **Example:** You can migrate to the Configuration Management Layer of Framework 8.0 while still using 7.x components. See the *Genesys 7 Interoperability Guide* for information on the compatibility of Genesys products with various Configuration Layer Environments; Interoperability of Reporting Templates and Solutions; and *Gplus* Adapters Interoperability.
- **Interoperability at the solution-specific level** means combining different versions of the components of a particular solution while upgrading them sequentially during the migration process.

The mixture of components may include executables, applications, routing strategies, scripts, and data that comprise a particular solution.

As you upgrade each of the components in sequence, you will need to know if it is backward-compatible with the other components of Interaction Concentrator.

Example: If you have four components to upgrade, determine if the first component you upgrade to version 8.0 will be backward compatible with the three 7.x components that are not upgraded yet.

Additional Information about Migration

The following information is also pertinent to the migration of Interaction Concentrator.

- You can migrate Interaction Concentrator from any version of release 7.5 or 7.6 directly to release 8.0.
- You can migrate Interaction Concentrator from any version of release 7.2 directly to release 7.5 or 7.6.
- You cannot migrate Interaction Concentrator from release 7.2 directly to release 8.0. To migrate to release 8.0 from any version of release 7.2, first migrate to any version of release 7.5 or 7.6, and then migrate to release 8.0.
- ICON processing must be suspended while the Interaction Concentrator migration is occurring. The content of the persistent queue file (`icon_**.pq`) is lost as a result of the upgrade. To minimize the loss of data, perform the upgrade when the contact center load is minimal.
- Stopping ICON does not stop the execution of any stored procedures that may be running or scheduled to run during the upgrade. In particular, if the merge or purge stored procedures are executing when you run the database scripts, these stored procedures will not be successfully dropped and then re-created. You will receive no notification that you did not upgrade these service procedures correctly.

To prevent this error, ensure that no stored procedures are running when you perform the upgrade. If you have automated the merge or purge procedures to run on a regular schedule, stop the schedule before you begin the upgrade. Genesys recommends that you allow enough time for two iterations of the merge procedure to complete before you start the upgrade,

in order to ensure that the gsysIRMerge stored procedure is not still in use or locked during the upgrade.

Note: For an overview about migration issues, see “Migration Roadmap,” Chapter 1 of this guide.



Chapter

44

Changes in Interaction Concentrator

This section provides information that you need to upgrade the components and configuration options of Interaction Concentrator from one release to the next. This section discusses only changes (additions, deletions, and modifications) in the product that need specifically to be addressed during the migration process. The product documentation for each release contains a comprehensive list of changes from release to release. In particular, review the “New in This Release” section of the latest *Interaction Concentrator Deployment Guide*.

There are three sections in this chapter:

- [Component Changes for Interaction Concentrator, page 711](#)
- [Changes to Configuration Options for Interaction Concentrator, page 718](#)
- [Changes to Interaction Database, page 725](#)

Component Changes for Interaction Concentrator

Table 120 on [page 712](#) lists the component changes for Interaction Concentrator from release 7.6.x to release 8.0.

Table 121 on [page 714](#) lists the component changes for Interaction Concentrator from release 7.2 to release 7.6.x.

For information about all the new features and functions in Interaction Concentrator 7.6 or Interaction Concentrator 8.0, see the *Interaction Concentrator Deployment Guide* and the *Interaction Concentrator User's Guide* for the applicable release.

Table 120: Component Changes from 7.6.x to 8.0

Current Component Name	Type of Change	Change Occurred in Version #	Details
Interaction Concentrator (ICON) Server	New functionality	8.0	Supports the configuration in which a network switch and multiple related Network T-Servers operate in load-balancing mode. In this kind of configuration, one ICON instance is able to create and maintain connections to multiple Network T-Servers working with the same switch in load-balancing mode.
	New functionality	8.0	Reliably indicates whether the endpoint associated with a party is an IVR device.
	New functionality	8.0	Properly handles user data that is updated by a routing strategy or an agent after the party's association with the interaction has been terminated (for example, the call was transferred).
	New functionality	8.0	Identifies whether the UserEvent that caused a record to be written to a custom states table came from a device at a time when that device was participating in an active call.
	New functionality	8.0	Enables downstream reporting applications to identify when data was not available and to evaluate the reliability of available data provided by T-Server, Interaction Server, Outbound Contact Server (OCS), and Configuration Server. As a corollary, provides a mechanism for downstream reporting applications, such as Genesys Info Mart, to support High Availability (HA) for configuration, voice, multimedia, and Outbound Contact Solution data when one of a pair of ICON instances fails.

Table 120: Component Changes from 7.6.x to 8.0 (Continued)

Current Component Name	Type of Change	Change Occurred in Version #	Details
ICON Server (continued)	New functionality	8.0	For deployments that use T-Server release 8.0 for the Alcatel A4400/OXE switch, provides sufficient information at the call and party level for downstream reporting applications to determine which party (caller or receiver) released the call.
	New functionality	8.0	If a virtual queue is involved in routing an interaction, stores information in IDB to identify the virtual queue. Note: Requires Universal Routing Server (URS) release 8.0, configured to attach the virtual queue DBID as user data.
	Operating system support added	8.0	Now additionally supports the following operating systems: <ul style="list-style-type: none"> • IBM AIX 64-bit version 6.1 • Red Hat Enterprise Linux AS Edition version 5, for 32-bit Intel platform • HP-UX/PA 64-bit version 11i v3 • Microsoft Windows Server 2008 on x86 and x64 platforms
	Operating system support discontinued	8.0	No longer supports the following operating systems: <ul style="list-style-type: none"> • Microsoft Windows Server version Win2000 on 32-bit Intel processors • Solaris/SPARC 32-/64-bit version 7 • HP-UX/PA 32-/64-bit version 11.00
	Virtual environment support added	8.0	Now supports the following virtual environments: <ul style="list-style-type: none"> • IBM PowerVM LPAR • Sun Solaris Containers

Table 120: Component Changes from 7.6.x to 8.0 (Continued)

Current Component Name	Type of Change	Change Occurred in Version #	Details
IDB	RDBMS support added	8.0	Now additionally supports the following RDBMSs: <ul style="list-style-type: none"> • Oracle 11g • Microsoft SQL Server 2008 • IBM DB2 9.5
	RDBMS support discontinued	8.0	No longer supports Microsoft SQL Server version 2000.
	Schema modified	8.0	For information about the schema changes, see Table 124 on page 726 .

Table 121: Component Changes from 7.2 to 7.6.x

Current Component Name	Type of Change	Change Occurred in Version #	Details
ICON Server	New functionality	7.6.100.10	<ul style="list-style-type: none"> • Supports a larger number of active Multimedia interactions concurrently. • Provides the ability to filter out some Multimedia data that is not relevant to reporting. • Provides a new purging mechanism—<code>gsysPurge76</code>— for voice and Multimedia data stored in Interaction Database (IDB). • Improved performance for purging voice data that is stored in IDB using the new purging mechanism. • Improvements made in the recognition of certain multi-site scenarios.

Table 121: Component Changes from 7.2 to 7.6.x (Continued)

Current Component Name	Type of Change	Change Occurred in Version #	Details
ICON Server (continued)	New functionality	7.6.000.16	<ul style="list-style-type: none"> Provides the ability to resynchronize the configuration data in IDB with Configuration Database on demand Enables database size optimization by providing a filtering mechanism for certain types of data Supports media types for Open Media in all the areas where e-mail and non-SIP data were previously supported Supports reporting on SIP chat. Provides an ability to identify if a chat session has the focus. Provides an ability to report after-call work (ACW) for the first interaction associated with ACW. Provides the ability to suppress the interruption of the ACW and NotReady agent states by interactions coming to, or produced by, the agent.
	Functionality changed	7.6.000.16	Improvements in merge procedure (gsysIRMerge) performance.
	New functionality	7.5.000.22	Provides the ability to resynchronize the configuration data in Interaction Database (IDB) with Configuration Database on demand.
	Functionality changed	7.5.000.22	Improvements in the purge stored procedure (gsysPurgeIR).
	New functionality	7.5.000.19	Provides the ability to filter out data related to a service observer on a call (see [filter-data] observer-party).

Table 121: Component Changes from 7.2 to 7.6.x (Continued)

Current Component Name	Type of Change	Change Occurred in Version #	Details
ICON Server (continued)	New functionality	7.5.000.16	Provides a new set of stored procedures to purge merged voice interaction data from IDB: <ul style="list-style-type: none"> • gsysPurgeIR • gsysPugeUDH • gsysPurgeLS • gsysPurge0S
	Operating system support added	7.5.000.12	Now supports the following operating systems: <ul style="list-style-type: none"> • IBM AIX 32-/64-bit versions 5.1, 5.2, and 5.3 • Microsoft Windows Server versions Win2000 and 2003 on 32-bit Intel processors • Microsoft Windows Server version Windows 2003 x64 • Solaris/Sparc 32-/64-bit versions 2.7, 8, 9, and 10 • Red Hat Enterprise Linux AS Edition on 32-bit Intel platforms, versions 3.0 and 4.0 • HP-UX PA 32-/64-bit versions 11.0 and 11.11 • HP Compaq TRU64/Alfa versions 4.0F, 5.1, and 5.1B • HP-UX IPF 64-bit version 11i ver. 2 (new)
	Operating system support discontinued	7.5.000.12	No longer supports the following operating systems: <ul style="list-style-type: none"> • IBM AIX 4.x line • Solaris Sparc version 2.6

Table 121: Component Changes from 7.2 to 7.6.x (Continued)

Current Component Name	Type of Change	Change Occurred in Version #	Details
ICON Server (continued)	New functionality	7.5.000.12	Supports reporting about: <ul style="list-style-type: none"> • Multimedia interactions (e-mail and chat), including agent state and login session reporting and attached data processing • Virtual queue usage in voice and Multimedia interaction processing • Virtual Routing Point (VRP) usage in call processing • Interactions generated in a network-based Contact Solution environment • Interactions generated in a Network Call Parking environment • Custom agent states and common data • Custom attached data processing
	Functionality changed	7.5.000.12	The design of the stored procedure to resolve stuck calls (<code>gsysStuckResolver</code>) has changed. The stored procedure no longer uses a configured timeout. ICON automatically calls the stored procedure on startup in order to resolve stuck calls. In the event of a disconnection, ICON uses a different internal mechanism to clean up stuck calls on reconnect. The user does not execute the stored procedure.
IDB	Schema modified	7.6.100.19	New IDB schema version: 7.6.100.09. For information about the schema changes, see Table 126 on page 727 .
	Schema modified	7.6.100.10	New IDB schema version: 7.6.100.07. For information about the schema changes, see Table 126 on page 727 .
	Schema modified	7.6.000.16	New IDB schema version: 7.6.000.15. For information about the schema changes, see Table 126 on page 727 .

Table 121: Component Changes from 7.2 to 7.6.x (Continued)

Current Component Name	Type of Change	Change Occurred in Version #	Details
IDB (continued)	New functionality	7.6.000.16	Stores extended metrics for virtual queue usage in interaction processing.
	Schema modified	7.5.000.22	New IDB schema version: 7.5.000.06. For information about the schema changes, see Table 126 on page 727 .
	Functionality changed	7.5.000.22	The design of the merge and purge procedures has changed.
	New functionality	7.2.000.17	Interaction Concentrator now captures the information required to support detailed reporting about virtual queue usage in interaction processing. IDB schema version 7.2.000.11 or above is required for this functionality.
	Schema modified	7.2.000.14	IDB schema version changed from 7.2.000.07 (in the initial release of Interaction Concentrator) to 7.2.000.11. For information about schema changes, see Table 126 on page 727 .

Changes to Configuration Options for Interaction Concentrator

Table 122 on [page 719](#) lists the changes to Interaction Concentrator–related configuration options between releases 7.6.1 and 8.0.

Table 123 on [page 719](#) lists the changes to Interaction Concentrator–related configuration options between releases 7.2 and 7.6.1.

For more detailed descriptions of all the ICON options, refer to the *Interaction Concentrator Deployment Guide*.

Table 122: Configuration Option Changes from 7.6.1 to 8.0

[Section] Option Name	Type of Change	Change Occurred in Version #	Details
ICON Application Object			
[callconcentrator] store-releasing-party	New option	8.0	Specifies whether ICON will store information, if it is reported by T-Server, that enables downstream reporting applications to determine which party released the call.
Switch Object			
[gts] load-balancing-on- ntwk-switch	New option	8.0	Specifies whether this is a network switch that operates in load-balancing mode with multiple Network T-Servers.

Table 123: Configuration Option Changes from 7.2 to 7.6.1

[Section] Option Name	Type of Change	Change Occurred in Version #	Details
ICON Application Object			
[callconcentrator] om-force-adata	New option	7.6.100.23	For deployments that have been configured to report data for multimedia interactions that started in the past (the [callconcentrator] calls-in-the-past configuration option has been set to true), specifies whether ICON stores a UserData snapshot that corresponds to the interaction-related data.
[callconcentrator] gls-active-reason-codes	New option	7.6.100.19	Specifies whether ICON will capture and store the values of active Agent state reason codes.
[callconcentrator] om-check-filter-flag	New option	7.6.100.10	Specifies whether or not ICON stores strategy activity according to the value of the [callconcentrator] om-activity-report option (defined on the script object of type simple routing). Note: This functionality requires Interaction Server release 7.6.1 or higher.

Table 123: Configuration Option Changes from 7.2 to 7.6.1 (Continued)

[Section] Option Name	Type of Change	Change Occurred in Version #	Details
[callconcentrator] om-max-in-memory	New option	7.6.100.10	Specifies the maximum number of active interactions that concurrently reside in an interaction queue or interaction workbin. Note: This functionality requires Interaction Server release 7.6.1 or higher.
[callconcentrator] om-memory- optimization	New option	7.6.100.10	Specifies whether or not memory utilization will be optimized. Note: This functionality requires Interaction Server release 7.6.1 or higher.
[callconcentrator] gcti-mode-monitoring	New option	7.6.000.21 Note: Also added to the 7.5.x release.	Regulates the mode that ICON uses for voice call scenario recognition.
[callconcentrator] agent-pstorage-name	New option	7.6.000.16	Specifies the name of the persistent queue file that ICON creates and uses to store HA agent-related information before writing the information to IDB.
[callconcentrator] calls-in-the-past	New option	7.6.000.16	Enables you to report data for Multimedia interactions that have started in the past.
[callconcentrator] extended-route-result	New option	7.6.000.16	Specifies whether ICON stores extended routing results—statuses of interactions distributed by URS 7.6—in IDB. Note: Universal Routing Server (URS) release 7.6 and Interaction Server release 7.6.000.18 (or higher) are required for this functionality.
[filter-data]	New section	7.6.000.16	Contains options that control Interaction Concentrator output to IDB.

Table 123: Configuration Option Changes from 7.2 to 7.6.1 (Continued)

[Section] Option Name	Type of Change	Change Occurred in Version #	Details
[filter-data]	New options	7.6.000.16	<p>The following new options in the [filter-data] section enable ICON to selectively exclude writing various types of data to IDB:</p> <ul style="list-style-type: none"> • acd-party-history • acd-party-metrics • call-history • call-metrics • external-party • gls-all • gls-ivr • gls-metrics • gls-no-person • gls-queue • gls-wm • ir-history • udata-history-terminated <p>For more information, see the chapter about configuration options in the <i>Interaction Concentrator Deployment Guide</i>.</p>
[callconcentrator] start-cfg-sync	New option	7.5.000.22	Supports the on-demand resynchronization of configuration data.
[filter-data] observer-party	New option	7.5.000.19	Specifies whether ICON should exclude, from IDB storage, data related to a service observer on a call.
[callconcentrator] db-schema-name	New option	7.5.000.12	Specifies the explicit schema name that ICON will use when executing stored procedures.
[callconcentrator] pq-backlog-alarm- threshold	New option	7.5.000.12	Specifies the maximum number of records allowed to be pending in the persistent queue for submission to IDB. When the threshold is reached, ICON generates log message 25025.

Table 123: Configuration Option Changes from 7.2 to 7.6.1 (Continued)

[Section] Option Name	Type of Change	Change Occurred in Version #	Details
[callconcentrator] pq-backlog-clearance- threshold	New option	7.5.000.12	Specifies the minimum number of records pending in the persistent queue at which ICON will generate message 25026, if it previously generated log message 25025 (see [callconcentrator] pq-backlog-alarm-threshold).
[callconcentrator] suppress-user-data	New option	7.5.000.12	Specifies whether ICON instructs T-Server to propagate attached data only when the attached data changes. This optimizes processing of attached data by reducing network traffic. Note: T-Server 7.5 is required for this functionality.
[callconcentrator] sync-call-data-limit	New option	7.5.000.12	Specifies the maximum number of pending synchronizations for calls and attached data.
[callconcentrator] tsync-threshold	New option	7.5.000.12	Specifies the maximum allowed time difference, in milliseconds, between the ICON host and the T-Server.
[custom-states]	New section (Options tab)	7.5.000.12	Contains configuration options to support ICON processing of custom agent states and common data.
[custom-states] AgentRecordUserTypes	New option	7.5.000.12	Defines the custom agent states.
[custom-states] AgentUserFields	New option	7.5.000.12	Specifies the fields in the G_CUSTOM_STATES table in which ICON will store values for the specified key names, for data sent while the DN was in a custom agent state.
[custom-states] EventData	New option	7.5.000.12	Specifies the list of key names for which ICON will store KVP data in the G_CUSTOM_DATA_S table.
[custom-states] GlobalData	New option	7.5.000.12	Specifies the list of key names for which ICON will store KVP data in the G_CUSTOM_DATA_P table.
[custom-states] store-event-data	New option	7.5.000.12	Specifies which, if any, KVP data ICON will store in the G_CUSTOM_DATA_S table.

Table 123: Configuration Option Changes from 7.2 to 7.6.1 (Continued)

[Section] Option Name	Type of Change	Change Occurred in Version #	Details
[callconcentrator] vq-write-mode	New option	7.2.000.17	Specifies how ICON writes to IDB information about a particular association between an interaction and a virtual queue.
[dbw-error-reactions]	New section (Options tab)	7.2.000.17	Contains configuration options that define ICON reactions to specific database error messages.
[dbw-error-reactions] <error-name>	New option	7.2.000.17	Defines the manner in which Interaction Concentrator reacts to a database error message that contains a particular text substring. Create a separate option for every database error message for which a certain reaction is required.
Switch Object			
[gts] gls-use-ts-id	New option	7.6.000.16	Specifies whether ICON uses the login session ID generated by T-Server or by itself when connecting to or disconnecting from T-Server.
[gts] sst-options	Name corrected	7.6.000.16	Name of this option was incorrect in previous versions of the <i>Interaction Concentrator Deployment Guide</i> .
[gts] gls-max-inactivity	Default value changed	7.6.000.16	The default value was changed from 8 hours to 0 (ICON will not check inactivity durations).
[gts] gls-max-duration	Default value changed	7.6.000.16	The default value was changed from 24 hours to 0 (ICON will not check session durations).
[gts] fix-time-stamps	Documented for the first time	7.5.000.16	Enables adjustment of timestamps when the CTI event contains an earlier timestamp than the timestamp from a previously received CTI event.
[gts] min-tsync-roundtrip	New option	7.5.000.12	Specifies the allowed amount of time, in milliseconds, for messages to be sent from ICON to T-Server and acknowledged by T-Server, for the purposes of time synchronization.

Table 123: Configuration Option Changes from 7.2 to 7.6.1 (Continued)

[Section] Option Name	Type of Change	Change Occurred in Version #	Details
[gts] stt-options	New option	7.2.000.14	Specifies the TEvents that ICON uses to recognize a single-step transfer.
[gts] support-dn-type-5	New option	7.2.000.17	Enables the processing of events pertaining to DNs of the Virtual Queue type that belong to the switch.
[gts] suppress-user-data	New option	7.5.000.12	Specifies whether the switch instructs T-Server to propagate attached data only when the attached data changes. This optimizes ICON processing of attached data by reducing network traffic.
DN Object			
[gts] ivr	New option	7.6.000.16	Specifies whether ICON treats this DN as an IVR port. By default, ICON identifies DNs as IVR ports using one of the following criteria: <ul style="list-style-type: none"> • DN has a type of Voice Treatment Port in Configuration Database. • DN has a type of ACD Position or Extension, but it also has an Associated DN property specified in Configuration Database at the time of ICON startup.
[gts] monitor	New option	7.2.000.17	Applicable only to DNs of the Virtual Queue type. Enables the processing of virtual queue-related events for the particular DN.
Script Object (of type simple routing)			
[callconcentrator] om-activity-report	New option	7.6.100.10	Specifies whether or not ICON will store activity data related to any Multimedia interaction handled by this strategy. <p>Note: This functionality requires Interaction Server release 7.6.1 or higher.</p>

Table 123: Configuration Option Changes from 7.2 to 7.6.1 (Continued)

[Section] Option Name	Type of Change	Change Occurred in Version #	Details
Script Object (of type interaction queue)			
[callconcentrator] om-memory-clean	New option	7.6.100.10	<p>Specifies whether or not ICON immediately removes interactions from operational memory.</p> <p>Note 1: The <code>[callconcentrator] om-memory-optimization</code> configuration option must be set to <code>true</code> for this option to work.</p> <p>Note 2: This functionality requires Interaction Server release 7.6.1 or higher.</p>

Changes to Interaction Database

This section provides summaries of the following changes:

- [IDB Changes from Release 7.6.1 to 8.0](#)
- [IDB Changes from Release 7.2 to 7.6.x](#) (see [page 727](#))

IDB Changes from Release 7.6.1 to 8.0

[Table 124](#) briefly describes the changes to the IDB schema between release 7.6.1 and release 8.0 of Interaction Concentrator. For more information about the IDB changes for Interaction Concentrator, refer to the *Interaction Concentrator Physical Data Model* for your RDBMS.

Table 124: IDB Changes from Interaction Concentrator 7.6.1 to 8.0

Type of Change	Change Occurred In Interaction Concentrator Release #	Details
Tables added	8.0	<p>To support the new functionality that enables downstream reporting applications to evaluate the availability and reliability of data in IDB, the following new tables store detailed data about connections, timestamps, and events from the various data sources:</p> <ul style="list-style-type: none"> • G_DSS_CFG_PROVIDER • G_DSS_GCC_PROVIDER • G_DSS_GLS_PROVIDER • G_DSS_GOS_PROVIDER • G_DSS_GUD_PROVIDER
Column usage changed	8.0	<p>The following fields are now used in the specified tables to support new 8.0 functionality:</p> <ul style="list-style-type: none"> • GSYS_DOMAIN in all operational tables • GSYS_EXT_INT1 in the G_PARTY_STAT and G_PARTY_HISTORY tables • GSYS_EXT_INT1 in the G_CUSTOM_DATA_* tables • GSYS_EXT_VCH1 in the G_CALL_STAT table • GSYS_EXT_VCH2 in the G_CALL_STAT table
Column usage clarified	8.0	<p>The following fields in the G_TIMECODE table are no longer flagged as mandatory and are identified as reserved for future use:</p> <ul style="list-style-type: none"> • TC_WEEKDAY • TC_WEEK • TC_DAYNAME • TC_WEEKNAME • TC_MONTHNAME
Stored procedures renamed	8.0	<p>Interaction Concentrator streamlines future migration by packaging the stored procedures that support each 8.x release in a release-specific set. A particular ICON release works only with the corresponding stored procedures package. Multiple sets of packages can exist in the same IDB, and an earlier set of stored procedures can work with a later version of the IDB schema.</p>

IDB Changes from Release 7.2 to 7.6.x

[Table 125](#) summarizes the IDB schema versions that are applicable for various Interaction Concentrator 7.x releases.

Table 125: IDB Versions for Interaction Concentrator 7.x

Interaction Concentrator Release	IDB Schema Version
7.2.000.09	7.2.000.07
7.2.000.14, 7.2.000.17, 7.2.000.18, 7.2.000.19, 7.2.000.20	7.2.000.11
7.5.000.12	7.5.000.03
7.5.000.16	7.5.000.05
7.5.000.17	7.5.000.05
7.5.000.18	7.5.000.05
7.5.000.19	7.5.000.05
7.5.000.22	7.5.000.06
7.6.000.16	7.6.000.15
7.6.100.10, 7.6.100.12, 7.6.100.14	7.6.100.07
7.6.100.19	7.6.100.09
7.6.100.23–7.6.100.29	7.6.100.23

[Table 126](#) briefly describes the changes to the IDB schema between release 7.2.x and release 7.6.x of Interaction Concentrator. For more information about the IDB changes for Interaction Concentrator, refer to the *Interaction Concentrator Deployment Guide*.

Table 126: IDB Changes from Interaction Concentrator 7.2.x to 7.6.x

Type of Change	Change Occurred In		Details
	Interaction Concentrator Release #	IDB Schema Version #	
New table	7.6.100.19	7.6.100.09	The following new table stores the values of active Agent state reason codes: <ul style="list-style-type: none"> G_AGENT_STATE_RC_A

Table 126: IDB Changes from Interaction Concentrator 7.2.x to 7.6.x (Continued)

Type of Change	Change Occurred In		Details
	Interaction Concentrator Release #	IDB Schema Version #	
New stored procedure	7.6.100.10	7.6.100.07	New stored procedure— <code>gsysPurge76</code> —purges voice, open media, multimedia, attached data, and agent login sessions interaction data from IDB. For more information, see the chapter about special stored procedures in the <i>Interaction Concentrator 7.6 User's Guide</i> .
New dictionary types	7.6.000.16	7.6.000.15	New dictionary types include: <ul style="list-style-type: none"> • call merge types (<code>CALL_MERGE_TYPE</code>) • reliability of route results (<code>ROUTE_RESULT_RELIABILITY</code>) • type of stop processing actor (<code>IXN_STOP_PROC_ACTOR_TYPE</code>)
New dictionary values	7.6.000.16	7.6.000.15	See Table 127 for a listing of the new values added to the dictionary tables.
Column usage changes	7.6.000.16	7.6.000.15	The following fields are now used in the specified tables to support new 7.6 functionality: <ul style="list-style-type: none"> • <code>GSYS_EXT_INT1</code> in the <code>GC_*</code>, <code>G_CX_*</code>, <code>G_PARTY</code>, <code>G_ROUTE_RESULT</code>, and <code>GM_L_USERDATA</code> tables • <code>GSYS_EXT_INT2</code> in the <code>G_AGENT_STATE_RC</code> and <code>G_CALL</code> tables • <code>GSYS_EXT_VCH1</code> in the <code>G_AGENT_SATE_HISTORY</code>, <code>G_AGENT_STATE_RC</code>, <code>GS_AGENT_STAT</code>, <code>GS_AGENT_STAT_WM</code>, <code>G_CALL</code>, <code>G_ROUTE_RESULT</code>, <code>GX_SESSION_ENDPOINT</code>, and <code>GM_L_USERDATA</code> tables • <code>GSYS_EXT_VCH2</code> in the <code>G_DND_HISTORY</code>, <code>G_IR</code>, and <code>GM_L_USERDATA</code> tables
Stored procedures changes	7.5.000.22	7.5.000.06	The merge and purge stored procedures were updated. For more information, see the chapter about special stored procedures in the <i>Interaction Concentrator 7.6 User's Guide</i> .
New index	7.5.000.22	7.5.000.06	A new index: <code>IDX_IS_LINK_LID_LOC</code> was added to the <code>LINKID</code> and <code>REMOTELOCATION</code> columns of the <code>G_IS_LINK</code> table.

Table 126: IDB Changes from Interaction Concentrator 7.2.x to 7.6.x (Continued)

Type of Change	Change Occurred In		Details
	Interaction Concentrator Release #	IDB Schema Version #	
New tables and indexes	7.5.000.16	7.5.000.05	<p>The following new tables support purge procedure operation:</p> <ul style="list-style-type: none"> • GSYS_DMGR_CAMP • GSYS_DMGR_CHAIN • GSYS_DMGR_GCC • GSYS_DMGR_GCC_SEQ • GSYS_DMGR_GLS <p>A number of new indexes support purge procedure operation and cleanup (see Table 128).</p>
New stored procedures	7.5.000.16	7.5.000.05	<p>New stored procedures implement optional purge functionality. The following are the primary procedures to purge merged voice interactions:</p> <ul style="list-style-type: none"> • gsysPurgeIR—Purges Interaction Records (IRs). • gsysPurgeUDH—Purges User Data History (UDH) data. • gsysPurgeLS—Purges Agent Login Session data. • gsysPurgeOS—Purges Outbound data. <p>For more information, see the chapter about special stored procedures in the <i>Interaction Concentrator 7.5 Deployment Guide</i>.</p>
Stored procedures changes	7.5.000.16	7.5.000.05	<p>Operation of the merge stored procedures (gsysIRMerge and gsysIRMerge2) changed.</p>
Data types/field sizes changes	7.5.000.12	7.5.000.03	<p>Data types changed from 50 to 255 characters for the following columns in the G_ROUTE_RESULT table:</p> <ul style="list-style-type: none"> • RTARGETRULESELECTED • RTARGETAGENTSELECTED • RTARGETPLACESELECTED • RSTRATEGYNAME • RTENANT

Table 126: IDB Changes from Interaction Concentrator 7.2.x to 7.6.x (Continued)

Type of Change	Change Occurred In		Details
	Interaction Concentrator Release #	IDB Schema Version #	
Stored procedures changes	7.5.000.12	7.5.000.03	<ul style="list-style-type: none"> • <code>gsysStuckResolver</code>—Functionality changed (see page 717). • <code>gsysIRMerge</code>—Implementation and operation changed. <code>gsysIRMerge</code> is now a wrapper for a reformulated merge procedure named <code>gsysIRMerge2</code>. Calls to <code>gsysIRMerge</code> 7.5 are compatible with calls to <code>gsysIRMerge</code> 7.2. To directly invoke <code>gsysIRMerge2</code>, you must now specify parameters. <p>For more information, see the chapter about special stored procedures in the <i>Interaction Concentrator 7.5 Deployment Guide</i>.</p>
Provision for custom dispatcher	7.5.000.12	7.5.000.03	ICON can support a stored procedure (either <code>gudCustDisp1</code> or <code>gudCustDisp2</code>) to provide customized attached data processing.
New dictionary values	7.5.000.12	7.5.000.03	<ul style="list-style-type: none"> • New values added to the dictionary tables to include metadata for different media types, to support reporting about Multimedia interactions (see database script <code>08_gcc_<db_type>_dict_3.sql</code>). • New values added to the dictionary tables to include metadata about Genesys Voice Platform (GVP) (see database script <code>03_gcc_<db_type>_dict.sql</code>).

Table 126: IDB Changes from Interaction Concentrator 7.2.x to 7.6.x (Continued)

Type of Change	Change Occurred In		Details
	Interaction Concentrator Release #	IDB Schema Version #	
Column usage changes	7.5.000.12	7.5.000.03	<p>The following fields, formerly reserved, are used to support Multimedia reporting:</p> <ul style="list-style-type: none"> • GSYS_EXT_INT1 in the G_IR and G_CALL table—A value of 1 indicates that the record is for a Multimedia interaction. • GSYS_EXT_INT1 in the GX_SESSION_ENDPOINT table and other configuration-related tables that contain information about agent states—Identifies the media type(s) associated with the agent login session, with new values for Multimedia specified in G_DICTIONARY. • GSYS_EXT_VCH1 in the G_IR table—Stores ID information for a parent interaction that was reported by Interaction Server but not found in a previous G_IR record.
New tables	7.5.000.12	7.5.000.03	<ul style="list-style-type: none"> • G_CUSTOM_DATA_P, G_CUSTOM_DATA_S, and G_CUSTOM_STATES tables added to support reporting about custom agent states. • GM_F_USERDATA and GM_L_USERDATA tables added to support attached data processing for Multimedia.
New table, new dictionary values, new internal stored procedures	7.2.000.14, 7.2.000.17	7.2.000.11	<ul style="list-style-type: none"> • G_VIRTUAL_QUEUE table added to support reporting about virtual queue usage. • New values added to the dictionary tables to include metadata about virtual queue states. • New call control–related stored procedures introduced to accommodate reporting about virtual queue usage and routing results.

Table 127 lists the new values added to dictionary tables in Interaction Concentrator release 7.6.000.16.

Table 127: New Values Added to Dictionary Tables in Release 7.6.000.16

Applicable Dictionary Type	New Dictionary ID Value	Dictionary Value Description
6	1000	OM
10	1	observer

Table 127: New Values Added to Dictionary Tables in Release 7.6.000.16 (Continued)

Applicable Dictionary Type	New Dictionary ID Value	Dictionary Value Description
21	3	failed
24	10	Syncinprogress
27	2	source
27	3	target
28	102	distributed_to_default
28	103	routed_by_switch
28	105	other_reasons
28	133	ixn_server_timeout
28	134	ixn_taken_out
30	-1	unknown
85	101	routed_in_parallel_vq
85	102	routed_to_default
85	103	routed_by_switch
85	104	execute_clear_target
85	105	other
85	133	ixn_routing_to
85	134	ixn_taken_out
86	-1	unknown
86	0	bridge
86	11	transfer
86	12	conference
87	0	unknown
87	1	ok
87	2	in_the_past
88	0	unknown
88	1	strategy
88	2	agent
88	3	place
88	4	media_server

For more detailed descriptions of the tables and columns in IDB, see the *Interaction Concentrator 7.6 Physical Data Model* document for your particular RDBMS.

[Table 128](#) lists the indexes created to support purge procedure functionality.

Table 128: Purge Procedure Indexes

Index Name	Table	Columns Indexed
I_G_AG_STAT_TS	GS_AGENT_STAT	ADDED_TS
I_G_AG_STAT_WM_TS	GS_AGENT_STAT_WM	ADDED_TS

Table 128: Purge Procedure Indexes (Continued)

Index Name	Table	Columns Indexed
I_G_AGST_HIST_TS	G_AGENT_STATE_HISTORY	ADDED_TS
I_G_AGST_RC_TS	G_AGENT_STATE_RC	CREATED_TS
I_G_DND_HIST_TS	G_DND_HISTORY	ADDED_TS
I_G_LSESS_TS	G_LOGIN_SESSION	CREATED_TS
I_G_SES_ENDP_TS	GX_SESSION_ENDPOINT	CREATED_TS
I_GO_CAMP_HIST_TS	GO_CAMPAIGNHISTORY	ADDED_TS
I_GO_CAMP_TS	GO_CAMPAIGN	CREATED_TS
I_GO_CAMPP_HIST_TS	GO_CAMPPROP_HIST	ADDED_TS
I_GO_CHAIN_TS	GO_CHAIN	CREATED_TS
I_GO_CHREC_H_TS	GO_CHAINREC_HIST	ADDED_TS
I_GO_CUST_F_TS	GO_CUSTOM_FIELDS	LOADED_TS
I_GO_H_HIST_TS	GO_FIELDHIST	ADDED_TS
I_GO_METRICS_TS	GO_METRICS	ADDED_TS
I_GO_REC_TS	GO_RECORD	LOADED_TS
I_GO_SEC_CUST_F_TS	GO_SECURE_FIELDS	LOADED_TS
I_GO_SEC_F_HIST_TS	GO_SEC_FIELDHIST	ADDED_TS
I_GOX_CH_CALL_TS	GOX_CHAIN_CALL	ADDED_TS
I_ISLINK_HIST_SEQ	G_IS_LINK_HISTORY	GSYS_SYS_ID, GSYS_SEQ
IDX_DMGRCAMP_TID	GSYS_DMGR_CAMP	
IDX_DMGRCHAIN_TID	GSYS_DMGR_CHAIN	
IDX_GDMGRGCC_TID1	GSYS_DMGR_GCC	
IDX_GDMGRGCC_TYPE	GSYS_DMGR_GCC	
IDX_GDMGRGLS_TID	GSYS_DMGR_GLS	
IDX_GPARTY_SEQ	G_PARTY	GSYS_SYS_ID, GSYS_SEQ
IDX_ROUTRES_SEQ	G_ROUTE_RESULT	GSYS_SYS_ID, GSYS_SEQ
IDX_SUD_HIST_TS	G_SECURE_USERDATA_HISTORY	ADDED_TS
IDX_UD_HIST_TS	G_USERDATA_HISTORY	ADDED_TS
IDX_VIRTQ_SEQ	G_VIRTUAL_QUEUE	GSYS_SYS_ID, GSYS_SEQ



Chapter

45

Migration Procedures

This chapter provides the migration procedures for Interaction Concentrator. Refer to other sections of this book for detailed information to help you migrate Framework and other Genesys solutions.

This chapter contains the following sections:

- [Migration to Release 8.0, page 735](#)
- [Migration to Release 7.x, page 741](#)

Migration to Release 8.0

This section describes the migration procedures for migrating to the latest 8.0.x release of Interaction Concentrator (ICON).

Note: You cannot migrate Interaction Concentrator from release 7.2 directly to release 8.0. To migrate to release 8.0 from any version of release 7.2, first migrate to any version of release 7.5 or 7.6, and then migrate to release 8.0.

As described in “Order of Migration” on [page 707](#), complete the following preliminary procedures before starting your migration of Interaction Concentrator:

1. Migrate Management Framework, as applicable for your deployment.
2. Upgrade other prerequisite Genesys components (for example, T-Server, Interaction Server, or Universal Routing Server), as applicable for your deployment.
3. Update the contact center configuration (for example, Place Groups, Agent Groups, and DNSs).

Migration Procedures

Follow these migration procedures for your solution:

- Upgrade ICON**
1. Back up the attached data configuration file (by default, `ccon_adata_spec.xml`). This file is located in the folder where your existing Interaction Concentrator application is installed.
 2. Import the application template for Interaction Concentrator 8.0.x.
For more detailed instructions, see the section about deploying Interaction Concentrator in the *Interaction Concentrator 8.0 Deployment Guide* chapter about configuration and installation.
 3. Create and configure a new 8.0.x Interaction Concentrator Application object.
For more detailed instructions, including all the necessary connections to servers, see the chapter about configuring and installing Interaction Concentrator in the *Interaction Concentrator 8.0 Deployment Guide*.

Note: If you are upgrading Interaction Concentrator in an environment with Genesys Info Mart 7.x, and Genesys Info Mart has already been extracting data from the Interaction Database (IDB) into which the existing ICON application stores data, do not create a new ICON application in the Configuration Layer. Instead, use the existing ICON application. Refer to the *Genesys Info Mart 7.6 Operations Guide* for more information.

4. Install ICON on its host.
For more detailed instructions about performing the installation for your operating system, see the section about deploying Interaction Concentrator in the *Interaction Concentrator 8.0 Deployment Guide* chapter about configuration and installation.

Note: Genesys recommends that you install the new ICON application in a different folder from your old ICON. If your company's file management policies do not allow this, stop ICON ([Step 5](#)) before installing the new ICON application ([Step 4](#)).

5. Stop ICON if it is running.
Genesys recommends that you use the Genesys Solution Control Interface (SCI) to stop ICON. For more detailed instructions, see the *Interaction Concentrator 8.0 Deployment Guide* chapter about starting and stopping ICON.

Note: The content of the persistent queue file (`icon_**.pq`) will be lost as a result of the upgrade. Do not back up the persistent queue file. To minimize the loss of data, perform the upgrade when the contact center load is minimal.

- Upgrade IDB** 6. (Optional) Back up IDB. Genesys recommends backing up IDB, but only if it is feasible to do so without prolonging the service interruption to an unacceptable extent. Backing up a very large IDB (while ICON is stopped) may interrupt data collection for too long.

Warning! Ensure that no stored procedures are running or are scheduled to run during the upgrade. Stopping ICON does not stop the execution of any stored procedures from the database side. In particular, if you have automated the merge or purge stored procedures to run on a regular schedule, stop the schedule before you begin the upgrade. Genesys recommends that you allow enough time for two iterations of the merge procedure to complete before you start the upgrade, in order to ensure that the merge stored procedure is not still in use or locked when you run the database scripts.

7. Execute the applicable database scripts to upgrade IDB. After installation of the ICON application ([Step 4 on page 736](#)), the scripts are located in the `scripts` subfolder in the directory to which you installed the application. [Table 129 on page 738](#) lists the scripts that you must run to upgrade from your existing IDB schema version. Execute the scripts in the order indicated in the table, starting with the first script that applies for the particular Interaction Concentrator release from which you are migrating. In the script names in [Table 129](#), `<db_type>` is a placeholder for the specific RDBMS type (`db2`, `mssql`, or `ora` [for Oracle]).

Example:

Say your RDBMS is Oracle; you are migrating from Interaction Concentrator release 7.6.100.14 in a multi-site deployment; and you use the `gsysPurge76` stored procedure to purge IDB. From the first column in [Table 129](#), you identify that you must start with script `6_UpgradeSchema_<db_type>.sql`. You then execute the following scripts in the order shown:

- `6_UpgradeSchema_ora.sql`
- `7_UpgradeSchema_ora.sql`
- `<n>_UpgradeSchema_ora.sql`—any scripts numbered 8_ or higher, if available
- `CoreProcedures_ora.sql`
- `Purge2_ora.sql`

- Wrapper_for_<version>.ora.sql, where <version> indicates the specific IDB schema version to which you are migrating.

Warning! To avoid destroying data that you have already collected, do not run any schema initialization scripts that are not listed in [Table 129](#) as applicable for your upgrade.

Table 129: IDB Scripts to Upgrade from Release 7.x to Release 8.0.x

Starting Point for Migration from Release	Script Name	Description
To use this table:		
<ol style="list-style-type: none"> 1. In the first column, find the row that refers to your current Interaction Concentrator release (the release from which you are migrating). 2. Following the order in the table, execute all the numbered scripts from that row onwards. 3. Following the order in the table, execute all the unnumbered scripts that apply to your deployment, as indicated in the description. 		
7.5.000.12 through 7.5.000.18	1_UpgradeSchema_<db_type>.sql	Upgrades the IDB schema.
7.5.000.22 through 7.6.000.16	2_UpgradeSchema_<db_type>.sql	Upgrades the IDB schema.
	3_UpgradeSchema_<db_type>.sql	Upgrades the IDB schema.
7.6.000.18 through 7.6.000.21	4_UpgradeSchema_<db_type>.sql	Upgrades the IDB schema.
	5_UpgradeSchema_<db_type>.sql	Upgrades the IDB schema.
7.6.100.10 through 7.6.100.14	6_UpgradeSchema_<db_type>.sql	Upgrades the IDB schema.
7.6.100.19 or later 7.6.100 release	7_UpgradeSchema_<db_type>.sql	Upgrades the IDB schema.
8.0.x	<n>_UpgradeSchema_<db_type>.sql	(If available) Upgrades the IDB schema.
	CoreProcedures_<db_type>.sql	Creates a new set of stored procedures, including the service procedures that support the optional merge and purge functionality (for purging by interaction record [IR]). This script is required for all deployments.

Table 129: IDB Scripts to Upgrade from Release 7.x to Release 8.0.x (Continued)

Starting Point for Migration from Release	Script Name	Description
	Purge2_<db_type>.sql	Re-creates the optional stored procedures for purging by partition. This script is required for deployments that use the gsysPurge76 purge procedure. ^a
	Wrapper_for_<schema_version>_<db_type>.sql	Links the merge and purge procedures from the previous schema to the equivalent stored procedures in the new sets. This script is required for deployments that use the merge procedures or the gsysPurgeIR, gsysPurgeUDH, gsysPurgeLS, or gsysPurgeOS purge procedures. ^a
	drop_<schema_version>_<db_type>.sql	(Optional) Removes the set of stored procedures for the specified IDB schema version. This script applies for all deployments migrating from an earlier 8.0 release. ^b

- a. For more information about the merge and purge procedures in Interaction Concentrator 8.0, see the chapter about using special stored procedures in the *Interaction Concentrator 8.0 User's Guide*.
- b. This script is provided for convenience. Interaction Concentrator functioning is not affected if you do not remove the old set of stored procedures. Do not execute this script until you are satisfied that the upgrade has succeeded (see [Step 11](#) on [page 740](#)), in case you need to roll back the migration. To retrieve information about the database schema version for your existing IDB, use the following SQL query:
- ```
select VAL from G_DB_PARAMETERS where SECT='schema' and OPT='version'
```

8. (Optional) If you want to add or enhance support for customized handling of user data that is attached to voice or multimedia interactions, create or modify the gudCustDISP1 or gudCustDISP2 stored procedures. You must also modify the attached data configuration file.

The Interaction Concentrator Installation Package (IP) includes an additional script, `SampleProc_<db_type>.sql`, as an example of the scripts required to create the database tables and stored procedures for customized attached data processing. For more information, see the section about configuring for the storage of attached data in the *Interaction Concentrator 8.0 Deployment Guide*.

---

**Note:** Carefully verify the syntax and operation of your modified gudCustDISP1 or gudCustDISP2 stored procedure. Any types of errors or RDBMS violations produced by the custom dispatcher stored procedure can affect ICON processing of all other attached data for voice calls and multimedia interactions.

---

**Complete the Migration**

9. Restore your attached data configuration file (by default, named `ccon_adata_spec.xml`) by replacing the file in the folder where your ICON 8.0 application is installed.
10. Start the 8.0 ICON. For more detailed instructions, see the *Interaction Concentrator 8.0 Deployment Guide* chapter about starting and stopping ICON.
11. Verify Interaction Concentrator 8.0 operation by looking for error messages in the log.  
If the upgrade of ICON fails, roll back the migration (see “Rollback Procedures” on [page 740](#)).
12. If the migration is successful, uninstall the former Interaction Concentrator application.

**Multi-Site Migration**

13. To migrate multi-site or multi-tenant deployments, repeat the migration steps as follows:
  - In a deployment in which each of multiple ICON instances writes to its own IDB, repeat all the steps ([Steps 1](#) through [12](#)) for each ICON instance and each IDB.
  - In a deployment in which multiple ICON instances all write to a single, centralized IDB, repeat [Steps 1](#) through [5](#) and [Steps 9](#) through [12](#) for each additional ICON instance.

---

**Note:** Before you migrate your multi-tenant deployment, verify that all tenants (including the Environment tenant), from whose resources (switches, DNSs, and agents) ICON will collect data, are added to the ICON Application.

---

For more information about multi-site migration issues, see “Multi-Site/Single-Site and Multi-Tenant Migration” on [page 707](#).

**Rollback Procedures**

If the upgrade of ICON fails (see [Step 11](#)), complete the following steps to roll back Interaction Concentrator 8.0 migration:

1. If you upgraded associated components (such as DB Server and T-Servers) and created new application objects when you upgraded them, modify the connections on the `Connections` tab of your old Interaction Concentrator Application object, to connect to the new applications.
2. Stop ICON 8.0.
3. Start ICON 7.x.



---

**Note:** ICON 7.5.x or 7.6.x can write to an IDB that has been migrated to release 8.0.

---

4. Uninstall the ICON 8.0 application.

---

## Migration to Release 7.x

This section describes the migration procedures for migrating to the latest general 7.x release of Interaction Concentrator (ICON): 7.5.000.16, 7.6.000.16, or 7.6.100.10. For information about migrating to later hot fix releases, see the Deployment Procedure for the specific release to which you are migrating.

---

**Note:** Except for the database scripts that you must run, the procedure for migrating from a particular 7.x release to a later 7.x release is always the same. Ensure that you use the IDB upgrade scripts that correspond to the release of Interaction Concentrator to which you are migrating.

---

As described in “Order of Migration” on [page 707](#), complete the following preliminary procedures before starting your migration of Interaction Concentrator:

1. Migrate Management Framework, as applicable for your deployment.
2. Upgrade other prerequisite Genesys components (for example, T-Server or Interaction Server), as applicable for your deployment.
3. Update the contact center configuration (for example, Place Groups, Agent Groups, and DNs).

## Migration Procedures

Follow these migration procedures for your solution:

- Upgrade ICON**
1. Back up the attached data configuration file (by default, `ccon_adata_spec.xml`). This file is located in the folder where your existing Interaction Concentrator application is installed.

---

**Note:** If you are upgrading from an earlier 7.5 release of Interaction Concentrator to a later 7.5 release, from an earlier 7.6.0 release to a later 7.6.0 release, or from an earlier 7.6.1 release to a later 7.6.1 release, skip [Step 2](#) and [Step 3](#).

---

2. Import the application template for Interaction Concentrator 7.x.x.  
For more detailed instructions, see the section about deploying Interaction Concentrator in the *Interaction Concentrator 7.x Deployment Guide* chapter about configuration and installation.

3. Create and configure a new 7.x.x Interaction Concentrator Application object.

For more detailed instructions, including all the necessary connections to servers, see the chapter about configuring and installing Interaction Concentrator in the *Interaction Concentrator 7.x Deployment Guide*.

---

**Note:** If you are upgrading Interaction Concentrator in an environment with Genesys Info Mart, and Genesys Info Mart has already been extracting data from the Interaction Database (IDB) into which the existing ICON application stores data, do not create a new ICON application in the Configuration Layer. Instead, use the existing ICON application. Refer to the *Genesys Info Mart 7.6 Operations Guide* for more information.

---

4. Install ICON on its host.

For more detailed instructions about performing the installation for your operating system, see the section about deploying Interaction Concentrator in the *Interaction Concentrator 7.x Deployment Guide* chapter about configuration and installation.

---

**Note:** Genesys recommends that you not install the upgraded Interaction Concentrator 7.x.x in the same folder as your existing Interaction Concentrator. If your company's file management policies do not allow you to create a new path for Interaction Concentrator 7.x, stop ICON ([Step 5](#)) before you install Interaction Concentrator ([Step 4](#)).

---

5. Stop ICON if it is running.

Genesys recommends that you use the Genesys Solution Control Interface (SCI) to stop ICON. For more detailed instructions, see the *Interaction Concentrator 7.x Deployment Guide* chapter about starting and stopping ICON.

---

**Note:** The content of the persistent queue file (icon\_\*\*.pq) will be lost as a result of the upgrade. Do not back up the persistent queue file. To minimize the loss of data, perform the upgrade when the contact center load is minimal.

---

- Upgrade IDB**
6. (Optional) Back up IDB. Genesys recommends backing up IDB, but only if it is feasible to do so without prolonging the service interruption to an unacceptable extent. Backing up a very large IDB (while ICON is stopped) may interrupt data collection for too long.

---

**Warning!** Ensure that no stored procedures are running or are scheduled to run during the upgrade. Stopping ICON does not stop the execution of any stored procedures from the database side. In particular, if you have automated the merge stored procedure to run on a regular schedule, stop the schedule before you begin the upgrade. Genesys recommends that you allow enough time for two iterations of the procedure to complete before you start the upgrade, in order to ensure that the merge stored procedure is not still in use or locked when you run the database scripts.

---

7. Execute the applicable database scripts to upgrade IDB. After installation of the ICON application ([Step 4 on page 742](#)), the scripts are located in the scripts subfolder in the directory to which you installed the application.

[Tables 132 through 134](#) list the scripts that you must run to upgrade from your existing IDB schema version. Use:

- [Table 130 on page 744](#) to upgrade from release 7.5.x to 7.6.100.10
- [Table 131 on page 746](#) to upgrade from release 7.5.x to 7.6.000.16
- [Table 132 on page 747](#) to upgrade from release 7.2.x to 7.6.100.10
- [Table 133 on page 750](#) to upgrade from release 7.2.x to 7.6.000.16
- [Table 134 on page 751](#) to upgrade from release 7.2.x to 7.5.000.16

Execute the scripts in the order indicated in the table, for the Interaction Concentrator release from which you are migrating.

The tables provide the scripts to migrate to the latest general release of Interaction Concentrator 7.6.1, 7.6.0, or 7.5, respectively. For information about migrating to later 7.x hot fix releases, see the Deployment Procedure for the specific release to which you are migrating.

To retrieve information about the database schema for your existing IDB, use the following SQL query:

```
select VAL from G_DB_PARAMETERS where SECT='schema' and
OPT='version'
```

For information about the IDB schema versions associated with the various Interaction Concentrator releases, see [Table 125 on page 727](#).

---

**Warning!** To avoid destroying data that you have already collected, do not run any schema initialization scripts that are not listed in [Tables 132 through 131](#) as applicable for your upgrade.

---

**Note:** The IDB initialization scripts for ICON release 7.5.000.12 or later create default (empty) custom dispatchers without first dropping any existing stored procedures named gudCustDisp1 and gudCustDisp2. This is to decrease the risk of overwriting customer-created stored procedures. However, if the custom dispatcher stored procedures gudCustDisp1 and gudCustDisp2 already exist in IDB, the script that creates stored procedures related to call control, login sessions, and user data will return an error, which you can ignore.

**Table 130: IDB Scripts to Upgrade from Releases 7.5.x/7.6.0 to Release 7.6.1**

| Script Name                       | Description                                                 | Release    |            |            |            |            |            |            |            |            |            |            |            |            |            |  |
|-----------------------------------|-------------------------------------------------------------|------------|------------|------------|------------|------------|------------|------------|------------|------------|------------|------------|------------|------------|------------|--|
|                                   |                                                             | 7.5.000.12 | 7.5.000.16 | 7.5.000.17 | 7.5.000.18 | 7.5.000.19 | 7.5.000.22 | 7.5.000.23 | 7.5.000.24 | 7.5.000.25 | 7.5.000.26 | 7.6.000.16 | 7.6.000.18 | 7.6.000.20 | 7.6.000.21 |  |
| 11_gcc_<db_type>_idx_change_5.sql | Creates indexes to various IDB tables.                      | 1          | 1          | 1          | 1          | 1          |            |            |            |            |            |            |            |            |            |  |
| 12_gcc_<db_type>_stp_api_4.sql    | Upgrades stored procedures for configuration data tracking. | 2          | 2          | 2          | 2          | 2          |            |            |            |            |            |            |            |            |            |  |
| 13_gcc_<db_type>_svc_change_5.sql | Changes in the service stored procedures.                   | 3          | 3          | 3          | 3          | 3          | 1          | 1          | 1          | 1          | 1          |            |            |            |            |  |
| 14_gcc_<db_type>_stp_api_5.sql    | Upgrades stored procedures for open media data tracking.    | 4          | 4          | 4          | 4          | 4          | 2          | 2          | 2          | 2          | 2          |            |            |            |            |  |
| 15_gcc_<db_type>_stp_sys_5.sql    | Upgrades special (service) stored procedures.               | 5          | 5          | 5          | 5          | 5          | 3          | 3          | 3          | 3          | 3          |            |            |            |            |  |
| 16_gcc_<db_type>_stp_api_6.sql    | Updates stored procedures for user data tracking.           | 6          | 6          | 6          | 6          | 6          | 4          | 4          | 4          | 4          | 4          | 1          |            |            |            |  |
| 17_gcc_<db_type>_idx_change_6.sql | Creates index for G_PARTY table.                            | 7          | 7          | 7          | 7          | 7          | 5          | 5          | 5          | 5          | 5          | 2          | 1          | 1          | 1          |  |

**Table 130: IDB Scripts to Upgrade from Releases 7.5.x/7.6.0 to Release 7.6.1**

| Script Name                     | Description                                                                                    | Release    |            |            |            |            |            |            |            |            |            |            |            |            |            |
|---------------------------------|------------------------------------------------------------------------------------------------|------------|------------|------------|------------|------------|------------|------------|------------|------------|------------|------------|------------|------------|------------|
|                                 |                                                                                                | 7.5.000.12 | 7.5.000.16 | 7.5.000.17 | 7.5.000.18 | 7.5.000.19 | 7.5.000.22 | 7.5.000.23 | 7.5.000.24 | 7.5.000.25 | 7.5.000.26 | 7.6.000.16 | 7.6.000.18 | 7.6.000.20 | 7.6.000.21 |
| 18_gcc_<db_type>_stp_api_7.sql  | Creates stored procedures related to call control, configuration data, and user data tracking. | 8          | 8          | 8          | 8          | 8          | 6          | 6          | 6          | 6          | 6          | 3          | 2          | 2          | 2          |
| 19_gcc_<db_type>_stp_sys_7.sql  | Upgrades merge procedure.                                                                      | 9          | 9          | 9          | 9          | 9          | 7          | 7          | 7          | 7          | 7          | 4          | 3          | 3          | 3          |
| 20_gcc_<db_type>_disp.sql       | Creates stored procedures for event dispatcher functionality.                                  | 10         | 10         | 10         | 10         | 10         | 8          | 8          | 8          | 8          | 8          | 5          | 4          | 4          | 4          |
| 21_gcc_<db_type>_dict.sql       | Populates the dictionary tables with metadata.                                                 | 11         | 11         | 11         | 11         | 11         | 9          | 9          | 9          | 9          | 9          | 6          |            |            |            |
| 22_gcc_<db_type>_version.sql    | Updates the version of the IDB schema.                                                         | 12         | 12         | 12         | 12         | 12         | 10         | 10         | 10         | 10         | 10         | 7          | 5          | 5          | 5          |
| gcc_<db_type>_clean_init.sql    | Creates tables and indexes in IDB to clean up (purge) the database.                            | 13         |            |            |            |            |            |            |            |            |            |            |            |            |            |
| gcc_<db_type>_clean_upgrade.sql | Updates tables and indexes in IDB to clean up (purge) the database.                            |            | 13         | 13         | 13         | 13         |            |            |            |            |            |            |            |            |            |
| gcc_<db_type>_clean_api.sql     | Creates stored procedures to purge IDB.                                                        | 14         | 14         | 14         | 14         | 14         | 11         | 11         | 11         | 11         | 11         |            |            |            |            |

**Table 130: IDB Scripts to Upgrade from Releases 7.5.x/7.6.0 to Release 7.6.1**

| Script Name                                                                                                                                                                                                                                                                                                                                                          | Description                                                                               | Release    |            |            |            |            |            |            |            |            |            |            |            |            |            |
|----------------------------------------------------------------------------------------------------------------------------------------------------------------------------------------------------------------------------------------------------------------------------------------------------------------------------------------------------------------------|-------------------------------------------------------------------------------------------|------------|------------|------------|------------|------------|------------|------------|------------|------------|------------|------------|------------|------------|------------|
|                                                                                                                                                                                                                                                                                                                                                                      |                                                                                           | 7.5.000.12 | 7.5.000.16 | 7.5.000.17 | 7.5.000.18 | 7.5.000.19 | 7.5.000.22 | 7.5.000.23 | 7.5.000.24 | 7.5.000.25 | 7.5.000.26 | 7.6.000.16 | 7.6.000.18 | 7.6.000.20 | 7.6.000.21 |
| purge_gcc_<db_type>_proc.sql                                                                                                                                                                                                                                                                                                                                         | Creates service table and stored procedures to new 7.6.1 purge IDB procedure gsysPurge76. | 15         | 15         | 15         | 15         | 15         | 12         | 12         | 12         | 12         | 12         | 8          | 6          | 6          | 6          |
| <p><b>Note:</b> The scripts subfolder includes two additional scripts—sample_gcc_&lt;db_type&gt;_custdisp_api.sql and sample_gcc_&lt;db_type&gt;_custdisp_schema.sql—to serve as examples of scripts required to customize attached data processing. Do not execute these scripts. For more information, see <a href="#">Step 9</a> on <a href="#">page 753</a>.</p> |                                                                                           |            |            |            |            |            |            |            |            |            |            |            |            |            |            |

**Table 131: IDB Scripts to Upgrade from Release 7.5.x to Release 7.6.0**

| Script Name                       | Description                                                   | Release    |            |            |            |            |            |            |            |
|-----------------------------------|---------------------------------------------------------------|------------|------------|------------|------------|------------|------------|------------|------------|
|                                   |                                                               | 7.5.000.12 | 7.5.000.16 | 7.5.000.17 | 7.5.000.18 | 7.5.000.19 | 7.5.000.22 | 7.5.000.23 | 7.5.000.24 |
| 11_gcc_<db_type>_idx_change_5.sql | Creates indexes to various IDB tables.                        | 1          | 1          | 1          | 1          | 1          |            |            |            |
| 12_gcc_<db_type>_stp_api_4.sql    | Upgrade stored procedures for configuration data tracking     | 2          | 2          | 2          | 2          | 2          |            |            |            |
| 13_gcc_<db_type>_svc_change_5.sql | Changes in the service stored procedures                      | 3          | 3          | 3          | 3          | 3          | 1          | 1          | 1          |
| 14_gcc_<db_type>_stp_api_5.sql    | Upgrade stored procedures for Open Media Data tracking        | 4          | 4          | 4          | 4          | 4          | 2          | 2          | 2          |
| 15_gcc_<db_type>_stp_sys_5.sql    | Upgrade special (service) stored procedures.                  | 5          | 5          | 5          | 5          | 5          | 3          | 3          | 3          |
| 16_gcc_<db_type>_disp.sql         | Creates stored procedures for event dispatcher functionality. | 6          | 6          | 6          | 6          | 6          | 4          | 4          | 4          |
| 17_gcc_<db_type>_dict.sql         | Populates the dictionary tables with metadata.                | 7          | 7          | 7          | 7          | 7          | 5          | 5          | 5          |

**Table 131: IDB Scripts to Upgrade from Release 7.5.x to Release 7.6.0 (Continued)**

| Script Name                                                                                                                                                                                                                                                                                                                                                                                    | Description                                                         | Release    |            |            |            |            |            |            |            |
|------------------------------------------------------------------------------------------------------------------------------------------------------------------------------------------------------------------------------------------------------------------------------------------------------------------------------------------------------------------------------------------------|---------------------------------------------------------------------|------------|------------|------------|------------|------------|------------|------------|------------|
|                                                                                                                                                                                                                                                                                                                                                                                                |                                                                     | 7.5.000.12 | 7.5.000.16 | 7.5.000.17 | 7.5.000.18 | 7.5.000.19 | 7.5.000.22 | 7.5.000.23 | 7.5.000.24 |
| 18_gcc_<db_type>_version.sql                                                                                                                                                                                                                                                                                                                                                                   | Updates the version of the IDB schema.                              | 8          | 8          | 8          | 8          | 8          | 6          | 6          | 6          |
| gcc_<db_type>_clean_init.sql                                                                                                                                                                                                                                                                                                                                                                   | Creates tables and indexes in IDB to clean up (purge) the database. | 9          |            |            |            |            |            |            |            |
| gcc_<db_type>_clean_upgrade.sql                                                                                                                                                                                                                                                                                                                                                                | Updates tables and indexes in IDB to clean up (purge) the database. |            | 9          | 9          | 9          | 9          |            |            |            |
| gcc_<db_type>_clean_api.sql                                                                                                                                                                                                                                                                                                                                                                    | Creates stored procedures to purge IDB.                             | 10         | 10         | 10         | 10         | 10         | 7          | 7          | 7          |
| <p><b>Note:</b> The scripts subfolder includes two additional scripts—<code>sample_gcc_&lt;db_type&gt;_custdisp_api.sql</code> and <code>sample_gcc_&lt;db_type&gt;_custdisp_schema.sql</code>—to serve as examples of scripts required to customize attached data processing. Do not execute these scripts. For more information, see <a href="#">Step 9</a> on <a href="#">page 753</a>.</p> |                                                                     |            |            |            |            |            |            |            |            |

**Table 132: IDB Scripts to Upgrade from Release 7.2.x to Release 7.6.1**

| Script Name                       | Description                                                         | Release    |            |            |            |            |            |            |            |
|-----------------------------------|---------------------------------------------------------------------|------------|------------|------------|------------|------------|------------|------------|------------|
|                                   |                                                                     | 7.2.000.09 | 7.2.000.14 | 7.2.000.17 | 7.2.000.18 | 7.2.000.19 | 7.2.000.20 | 7.2.000.21 | 7.2.000.22 |
| 04_gcc_<db_type>_schema_2.sql     | Upgrades the IDB schema to include the G_VIRTUAL_QUEUE table.       | 1          |            |            |            |            |            |            |            |
| 05_gcc_<db_type>_stp_api_2.sql    | Creates stored procedures that associate calls with Virtual Queues. | 2          |            |            |            |            |            |            |            |
| 06_gcc_<db_type>_schema_3.sql     | Upgrades the IDB schema to include custom-state tables.             | 3          | 1          | 1          | 1          | 1          | 1          | 1          | 1          |
| 07_gcc_<db_type>_idx_change_3.sql | Creates indexes to various IDB tables.                              | 4          | 2          | 2          | 2          | 2          | 2          | 2          | 2          |

**Table 132: IDB Scripts to Upgrade from Release 7.2.x to Release 7.6.1 (Continued)**

| Script Name                       | Description                                                                                    | Release    |            |            |            |            |            |            |            |
|-----------------------------------|------------------------------------------------------------------------------------------------|------------|------------|------------|------------|------------|------------|------------|------------|
|                                   |                                                                                                | 7.2.000.09 | 7.2.000.14 | 7.2.000.17 | 7.2.000.18 | 7.2.000.19 | 7.2.000.20 | 7.2.000.21 | 7.2.000.22 |
| 08_mcr_<db_type>_schema.sql       | Upgrades the IDB schema to include the Multimedia user data tables.                            | 5          | 3          | 3          | 3          | 3          | 3          | 3          | 3          |
| 09_gcc_<db_type>_stp_api_3.sql    | Creates stored procedures related to call control, login sessions, and user data.              | 6          | 4          | 4          | 4          | 4          | 4          | 4          | 4          |
| 10_gcc_<db_type>_stp_sys_3.sql    | Creates special (service) stored procedures.                                                   | 7          | 5          | 5          | 5          | 5          | 5          | 5          | 5          |
| 11_gcc_<db_type>_idx_change_5.sql | Creates indexes to various IDB tables.                                                         | 8          | 6          | 6          | 6          | 6          | 6          | 6          | 6          |
| 12_gcc_<db_type>_stp_api_4.sql    | Upgrades stored procedures for configuration data tracking.                                    | 9          | 7          | 7          | 7          | 7          | 7          | 7          | 7          |
| 13_gcc_<db_type>_svc_change_5.sql | Changes in the service stored procedures.                                                      | 10         | 8          | 8          | 8          | 8          | 8          | 8          | 8          |
| 14_gcc_<db_type>_stp_api_5.sql    | Upgrades stored procedures for Open Media Data tracking.                                       | 11         | 9          | 9          | 9          | 9          | 9          | 9          | 9          |
| 15_gcc_<db_type>_stp_sys_5.sql    | Upgrades special (service) stored procedures.                                                  | 12         | 10         | 10         | 10         | 10         | 10         | 10         | 10         |
| 16_gcc_<db_type>_stp_api_6.sql    | Upgrades stored procedures for user data tracking.                                             | 13         | 11         | 11         | 11         | 11         | 11         | 11         | 11         |
| 17_gcc_<db_type>_idx_change_6.sql | Creates index for G_PARTY IDB table.                                                           | 14         | 12         | 12         | 12         | 12         | 12         | 12         | 12         |
| 18_gcc_<db_type>_stp_api_7.sql    | Creates stored procedures related to call control, configuration data, and user data tracking. | 15         | 13         | 13         | 13         | 13         | 13         | 13         | 13         |
| 19_gcc_<db_type>_stp_sys_7.sql    | Upgrades merge procedure.                                                                      | 16         | 14         | 14         | 14         | 14         | 14         | 14         | 14         |



**Table 132: IDB Scripts to Upgrade from Release 7.2.x to Release 7.6.1 (Continued)**

| Script Name                                                                                                                                                                                                                                                                                                                                                                                    | Description                                                                                 | Release    |            |            |            |            |            |            |            |
|------------------------------------------------------------------------------------------------------------------------------------------------------------------------------------------------------------------------------------------------------------------------------------------------------------------------------------------------------------------------------------------------|---------------------------------------------------------------------------------------------|------------|------------|------------|------------|------------|------------|------------|------------|
|                                                                                                                                                                                                                                                                                                                                                                                                |                                                                                             | 7.2.000.09 | 7.2.000.14 | 7.2.000.17 | 7.2.000.18 | 7.2.000.19 | 7.2.000.20 | 7.2.000.21 | 7.2.000.22 |
| 20_gcc_<db_type>_disp.sql                                                                                                                                                                                                                                                                                                                                                                      | Creates stored procedures for event dispatcher functionality.                               | 17         | 15         | 15         | 15         | 15         | 15         | 15         | 15         |
| 21_gcc_<db_type>_dict.sql                                                                                                                                                                                                                                                                                                                                                                      | Populates the dictionary tables with metadata.                                              | 18         | 16         | 16         | 16         | 16         | 16         | 16         | 16         |
| 22_gcc_<db_type>_version.sql                                                                                                                                                                                                                                                                                                                                                                   | Updates the version of the IDB schema.                                                      | 19         | 17         | 17         | 17         | 17         | 17         | 17         | 17         |
| gcc_<db_type>_clean_init.sql                                                                                                                                                                                                                                                                                                                                                                   | Creates tables and indexes in IDB to clean up (purge) the database.                         | 20         | 18         | 18         | 18         | 18         | 18         | 18         | 18         |
| gcc_<db_type>_clean_upgrade.sql                                                                                                                                                                                                                                                                                                                                                                | Updates tables and indexes in IDB to clean up (purge) the database.                         |            |            |            |            |            |            |            |            |
| gcc_<db_type>_clean_api.sql                                                                                                                                                                                                                                                                                                                                                                    | Creates stored procedures to purge IDB.                                                     | 21         | 19         | 19         | 19         | 19         | 19         | 19         | 19         |
| purge_gcc_<db_type>_proc.sql                                                                                                                                                                                                                                                                                                                                                                   | Creates service tables and stored procedures to new 7.6.1 purge IDB procedure, gsysPurge76. | 22         | 20         | 20         | 20         | 20         | 20         | 20         | 20         |
| <p><b>Note:</b> The scripts subfolder includes two additional scripts—<code>sample_gcc_&lt;db_type&gt;_custdisp_api.sql</code> and <code>sample_gcc_&lt;db_type&gt;_custdisp_schema.sql</code>—to serve as examples of scripts required to customize attached data processing. Do not execute these scripts. For more information, see <a href="#">Step 9</a> on <a href="#">page 753</a>.</p> |                                                                                             |            |            |            |            |            |            |            |            |

**Table 133: IDB Scripts to Upgrade from Release 7.2.x to Release 7.6.0**

| Script Name                       | Description                                                                       | Release    |            |            |            |            |            |            |            |
|-----------------------------------|-----------------------------------------------------------------------------------|------------|------------|------------|------------|------------|------------|------------|------------|
|                                   |                                                                                   | 7.2.000.09 | 7.2.000.14 | 7.2.000.17 | 7.2.000.18 | 7.2.000.19 | 7.2.000.20 | 7.2.000.21 | 7.2.000.22 |
| 04_gcc_<db_type>_schema_2.sql     | Upgrades the IDB schema to include the G_VIRTUAL_QUEUE table.                     | 1          |            |            |            |            |            |            |            |
| 05_gcc_<db_type>_stp_api_2.sql    | Creates stored procedures that associate calls with Virtual Queues.               | 2          |            |            |            |            |            |            |            |
| 06_gcc_<db_type>_schema_3.sql     | Upgrades the IDB schema to include custom-state tables.                           | 3          | 1          | 1          | 1          | 1          | 1          | 1          | 1          |
| 07_gcc_<db_type>_idx_change_3.sql | Creates indexes to various IDB tables.                                            | 4          | 2          | 2          | 2          | 2          | 2          | 2          | 2          |
| 08_mcr_<db_type>_schema.sql       | Upgrades the IDB schema to include the Multimedia user data tables.               | 5          | 3          | 3          | 3          | 3          | 3          | 3          | 3          |
| 09_gcc_<db_type>_stp_api_3.sql    | Creates stored procedures related to call control, login sessions, and user data. | 6          | 4          | 4          | 4          | 4          | 4          | 4          | 4          |
| 10_gcc_<db_type>_stp_sys_3.sql    | Creates special (service) stored procedures.                                      | 7          | 5          | 5          | 5          | 5          | 5          | 5          | 5          |
| 11_gcc_<db_type>_idx_change_5.sql | Creates indexes to various IDB tables.                                            | 8          | 6          | 6          | 6          | 6          | 6          | 6          | 6          |
| 12_gcc_<db_type>_stp_api_4.sql    | Upgrades stored procedures for configuration data tracking                        | 9          | 7          | 7          | 7          | 7          | 7          | 7          | 7          |
| 13_gcc_<db_type>_svc_change_5.sql | Changes in the service stored procedures                                          | 10         | 8          | 8          | 8          | 8          | 8          | 8          | 8          |
| 14_gcc_<db_type>_stp_api_5.sql    | Upgrades stored procedures for Open Media Data tracking                           | 11         | 9          | 9          | 9          | 9          | 9          | 9          | 9          |
| 15_gcc_<db_type>_stp_sys_5.sql    | Upgrades special (service) stored procedures.                                     | 12         | 10         | 10         | 10         | 10         | 10         | 10         | 10         |

**Table 133: IDB Scripts to Upgrade from Release 7.2.x to Release 7.6.0 (Continued)**

| Script Name                                                                                                                                                                                                                                                                                                                                                                                    | Description                                                         | Release    |            |            |            |            |            |            |            |
|------------------------------------------------------------------------------------------------------------------------------------------------------------------------------------------------------------------------------------------------------------------------------------------------------------------------------------------------------------------------------------------------|---------------------------------------------------------------------|------------|------------|------------|------------|------------|------------|------------|------------|
|                                                                                                                                                                                                                                                                                                                                                                                                |                                                                     | 7.2.000.09 | 7.2.000.14 | 7.2.000.17 | 7.2.000.18 | 7.2.000.19 | 7.2.000.20 | 7.2.000.21 | 7.2.000.22 |
| 16_gcc_<db_type>_disp.sql                                                                                                                                                                                                                                                                                                                                                                      | Creates stored procedures for event dispatcher functionality.       | 13         | 11         | 11         | 11         | 11         | 11         | 11         | 11         |
| 17_gcc_<db_type>_dict.sql                                                                                                                                                                                                                                                                                                                                                                      | Populates the dictionary tables with metadata.                      | 14         | 12         | 12         | 12         | 12         | 12         | 12         | 12         |
| 18_gcc_<db_type>_version.sql                                                                                                                                                                                                                                                                                                                                                                   | Updates the version of the IDB schema.                              | 15         | 13         | 13         | 13         | 13         | 13         | 13         | 13         |
| gcc_<db_type>_clean_init.sql                                                                                                                                                                                                                                                                                                                                                                   | Creates tables and indexes in IDB to clean up (purge) the database. | 16         | 14         | 14         | 14         | 14         | 14         | 14         | 14         |
| gcc_<db_type>_clean_upgrade.sql                                                                                                                                                                                                                                                                                                                                                                | Updates tables and indexes in IDB to clean up (purge) the database. |            |            |            |            |            |            |            |            |
| gcc_<db_type>_clean_api.sql                                                                                                                                                                                                                                                                                                                                                                    | Creates stored procedures to purge IDB.                             | 17         | 15         | 15         | 15         | 15         | 15         | 15         | 15         |
| <p><b>Note:</b> The scripts subfolder includes two additional scripts—<code>sample_gcc_&lt;db_type&gt;_custdisp_api.sql</code> and <code>sample_gcc_&lt;db_type&gt;_custdisp_schema.sql</code>—to serve as examples of scripts required to customize attached data processing. Do not execute these scripts. For more information, see <a href="#">Step 9</a> on <a href="#">page 753</a>.</p> |                                                                     |            |            |            |            |            |            |            |            |

**Table 134: IDB Scripts to Upgrade from Release 7.2.x to Release 7.5**

| Script Name                 | Description                                                                | Release    |                        |            |
|-----------------------------|----------------------------------------------------------------------------|------------|------------------------|------------|
|                             |                                                                            | 7.2.000.09 | 7.2.000.14 (or higher) | 7.5.000.12 |
| 03_gcc_<db_type>_dict.sql   | Populates the dictionary tables with metadata.                             | 1          | 1                      |            |
| 05_gcc_<db_type>_dict_2.sql | Upgrades the dictionary tables to include causes for Virtual Queue states. | 2          |                        |            |

**Table 134: IDB Scripts to Upgrade from Release 7.2.x to Release 7.5 (Continued)**

| Script Name                                                                                                                                                                                                                                                                                                                              | Description                                                                       | Release    |                           |            |
|------------------------------------------------------------------------------------------------------------------------------------------------------------------------------------------------------------------------------------------------------------------------------------------------------------------------------------------|-----------------------------------------------------------------------------------|------------|---------------------------|------------|
|                                                                                                                                                                                                                                                                                                                                          |                                                                                   | 7.2.000.09 | 7.2.000.14<br>(or higher) | 7.5.000.12 |
| 06_gcc_<db_type>_schema_2.sql                                                                                                                                                                                                                                                                                                            | Upgrades the IDB schema to include the 6_VIRTUAL_QUEUE table.                     | 3          |                           |            |
| 07_gcc_<db_type>_stp_api_2.sql                                                                                                                                                                                                                                                                                                           | Creates stored procedures that associate calls with Virtual Queues.               | 4          |                           |            |
| 08_gcc_<db_type>_dict_3.sql                                                                                                                                                                                                                                                                                                              | Upgrades the dictionary tables to include metadata for different media types.     | 5          | 2                         |            |
| 09_gcc_<db_type>_schema_3.sql                                                                                                                                                                                                                                                                                                            | Upgrades the IDB schema to include custom-state tables.                           | 6          | 3                         |            |
| 10_gcc_<db_type>idx_change_3.sql                                                                                                                                                                                                                                                                                                         | Creates indexes to various IDB tables.                                            | 7          | 4                         |            |
| 11_mcr_<db_type>_schema.sql                                                                                                                                                                                                                                                                                                              | Upgrades the IDB schema to include the Multimedia user data tables.               | 8          | 5                         |            |
| 12_gcc_<db_type>_stp_api_3.sql                                                                                                                                                                                                                                                                                                           | Creates stored procedures related to call control, login sessions, and user data. | 9          | 6                         |            |
| 13_gcc_<db_type>_stp_sys.sql                                                                                                                                                                                                                                                                                                             | Creates special (service) stored procedures.                                      | 10         | 7                         | 1          |
| 14_gcc_<db_type>_disp.sql                                                                                                                                                                                                                                                                                                                | Creates stored procedures for event dispatcher functionality.                     | 11         | 8                         |            |
| 15_gcc_<db_type>_version.sql                                                                                                                                                                                                                                                                                                             | Updates the version of the IDB schema.                                            | 12         | 9                         | 2          |
| gcc_<db_type>_clean_init.sql (optional)                                                                                                                                                                                                                                                                                                  | Creates tables and indexes in IDB to clean up the database after purging.         | 13         | 10                        | 3          |
| gcc_<db_type>_clean_api.sql (optional)                                                                                                                                                                                                                                                                                                   | Creates stored procedures to purge IDB.                                           | 14         | 11                        | 4          |
| <p><b>Note:</b> The scripts subfolder includes two additional scripts—sample_gcc_&lt;db_type&gt;_custdisp_api.sql and sample_gcc_&lt;db_type&gt;_custdisp_schema.sql—to serve as examples of scripts required to customize attached data processing. Do not execute these scripts. For more information, see <a href="#">Step 9</a>.</p> |                                                                                   |            |                           |            |

8. If you are upgrading from an ICON release earlier than 7.5.000.12 to release 7.5.000.12 or later, prepare and run ALTER TABLE scripts to further modify the existing schema. For details about the required modifications, see “Data types/field sizes changes” on [page 729](#).

9. (Optional) To implement Interaction Concentrator 7.6 support for customized handling of user data that is attached to voice calls, modify the empty `gudCustDisp1` or `gudCustDisp2` stored procedures that the IDB scripts create. You must also modify the attached data configuration file.

The `sample_gcc_<db_type>_custdisp_api.sql` script is an example of how you can modify the custom dispatcher stored procedure. Similarly, the `sample_gcc_<db_type>_custdisp_schema.sql` script is an example of a script to create a custom attached data storage table.

For more information, see the section about customized attached data processing, in the *Interaction Concentrator 7.6 Deployment Guide* chapter about attached data.

---

**Note:** Carefully verify the syntax and operation of your modified `gudCustDisp1` or `gudCustDisp2` stored procedure. Any types of errors or RDBMS violations produced by the custom dispatcher stored procedure can affect ICON processing of all other attached data for voice calls and Multimedia interactions.

---

#### Complete the Migration

10. Restore the attached data configuration file (by default, named `ccon_adata_spec.xml`).
  - a. Update the attached data configuration file as required to implement the new functionality provided by the Interaction Concentrator release to which you are upgrading. For more information, see the chapter about attached data in the *Interaction Concentrator 7.6 User's Guide* or the *Interaction Concentrator 7.5 Deployment Guide*, as applicable.
  - b. Replace the attached data configuration file in the folder where your upgraded Interaction Concentrator 7.x application is installed.
11. Start the upgraded 7.x ICON. For more detailed instructions, see the *Interaction Concentrator 7.x Deployment Guide* chapter about starting and stopping ICON.
12. Verify Interaction Concentrator 7.x operation by looking for error messages in the log.
 

If the upgrade of ICON fails, roll back the migration (see “Rollback Procedures” on [page 754](#)).
13. If the migration is successful, uninstall the former Interaction Concentrator application.

#### Multi-Site Migration

14. To migrate multi-site or multi-tenant deployments, repeat the migration steps as follows:
  - In a deployment in which each of multiple ICON instances writes to its own IDB, repeat all the steps ([Steps 1 through 13](#)) for each ICON instance and each IDB.

- In a deployment in which multiple ICON instances all write to a single, centralized IDB, repeat [Steps 1 through 5](#) and [Steps 10 through 13](#) for each additional ICON instance.

---

**Note:** Before you migrate your multi-tenant deployment, verify that all tenants (including the Environment tenant), from whose resources (switches, DNs, and agents) ICON will collect data, are added to the ICON Application.

---

For more information about multi-site migration issues, see “Multi-Site/Single-Site and Multi-Tenant Migration” on [page 707](#).

### Rollback Procedures

If the upgrade of ICON fails (see [Step 12](#) on [page 753](#)), complete the following steps to roll back Interaction Concentrator 7.6.x migration:

1. On the **Connections** tab of the former Interaction Concentrator Application object, modify the connections as required, to connect to the upgraded Management Framework components (DB Server and Database Access Points) and T-Servers.
2. Stop ICON.
3. Start ICON.

---

**Note:** An earlier ICON can write to an IDB that has been migrated to a later release.

---

4. Re-create the old merge stored procedure:
  - If you migrated from release 7.2 or 7.5 to release 7.6.x, run `10_gcc_<db_type>_stp_sys_3.sql` (in the ICON 7.6 scripts folder).
  - If you migrated from release 7.2 or 7.5 to release 7.5.x, run `13_gcc_<db_type>_stp_sys.sql` (in the ICON 7.5 scripts folder).
5. Uninstall the upgraded Interaction Concentrator 7.x.x application.



## Part

# 15

## Genesys Info Mart Migration

The chapters in this section describe the migration process for Genesys Info Mart. They also describe how to migrate other Genesys solutions, and third-party software components, that support and enable Genesys Info Mart functionality.

The information is divided into the following chapters:

- [Chapter 46, “Introduction to Genesys Info Mart Migration,” on page 757,](#) provides an introduction to Genesys Info Mart migration.
- [Chapter 47, “Changes in Genesys Info Mart 7.x,” on page 765,](#) describes the changes in Genesys Info Mart functionality from one release to the next.
- [Chapter 48, “Genesys Info Mart Migration Procedures,” on page 809,](#) presents a high-level description of the procedures that you must follow to deploy or migrate Genesys Info Mart.

Before proceeding, review the architecture section in the *Genesys Info Mart Deployment Guide* to familiarize yourself with the product architecture.

---

### Notes:

- The current version of this document covers migration information for Genesys Info Mart up to general release 7.6.006. If you are migrating your Genesys Info Mart from release 7.5, 7.2, or 7.0 to a general release later than 7.6.006.x, contact Genesys Technical Support for available migration instructions. If you are upgrading your Genesys Info Mart from a 7.6 release to a later 7.6 release, consult the Deployment Procedure supplied with the release to which you are upgrading.
  - Be sure to review the information in all the Genesys Info Mart Migration chapters before performing any migration procedures.
-







## Chapter

# 46

## Introduction to Genesys Info Mart Migration

Genesys Info Mart produces a data mart containing several star schemas you can use for contact center historical reporting. The following Genesys Info Mart migration scenarios are described in this guide:

- Migration from Genesys Info Mart 7.5.x to Genesys Info Mart 7.6.x.
- Migration from Genesys Info Mart 7.2.x to Genesys Info Mart 7.6.x.
- Migration from Genesys Info Mart 7.2.x to Genesys Info Mart 7.5.x.
- Migration from Genesys Info Mart 7.0.2 to Genesys Info Mart 7.6.x.
- Migration from Genesys Info Mart 7.0.2 to Genesys Info Mart 7.5.x.
- Migration from Genesys Info Mart 7.0.2 to Genesys Info Mart 7.2.0.
- Migration from Genesys Info Mart 7.0.1 to Genesys Info Mart 7.0.2.

---

**Note:** Your migration considerations include Genesys Info Mart software and its supporting software components.

---

This chapter contains the following sections:

- [“Preliminary Migration Procedures” on page 758](#), describes preliminary migration procedures and factors you need to consider as you plan your Genesys Info Mart migration.
- [“Supporting Software Components” on page 759](#), describes the software components that support or enable Genesys Info Mart functionality.
- [“Genesys Info Mart Migration Matrix” on page 761](#), lists the procedures necessary for migration from your current Genesys Info Mart release to the target release.
- [“Reference Materials” on page 763](#), contains a list of technical publications that will help you plan and implement your Genesys Info Mart migration.

---

## Preliminary Migration Procedures

The migration process includes these preliminary procedures for Genesys Info Mart.

1. Review the “Migration Roadmap” section of the *Genesys Migration Guide*.
2. Review “Supporting Software Components” on [page 759](#) for a list of software components that support Genesys Info Mart functionality.
3. Review the chapter about planning in the *Genesys Info Mart Deployment Guide* to familiarize yourself with the factors you need to consider when planning your Genesys Info Mart deployment.
4. Review the licensing requirements for Genesys Info Mart. See the *Genesys Licensing Guide* for more information.

---

**Note:** Starting with release 7.5, Genesys Info Mart does not require technical licenses.

---

5. See the *Genesys 7 Interoperability Guide* and the *Genesys 8 Interoperability Guide* for information on the compatibility of Genesys products with various Configuration Layer Environments; Interoperability of Reporting Templates and Solutions; and *Gplus* Adapters Interoperability.
6. Review the new features and component changes in the appropriate release-specific sections in “Changes in Genesys Info Mart 7.x” on [page 765](#).
7. Review the configuration option changes in the appropriate release-specific sections in “Changes in Genesys Info Mart 7.x” on [page 765](#). For complete information about configuration options, see the *Genesys Info Mart Deployment Guide*.
8. Review the Info Mart database schema changes in the appropriate release-specific sections in “Changes in Genesys Info Mart 7.x” on [page 765](#). For complete information about the Info Mart database schema, see the *Genesys Info Mart Reference Manual* for your DB2, Microsoft SQL Server, or Oracle database.

## Supporting Software Components

Several software components support Genesys Info Mart functionality. [Table 135](#) provides a list of supporting software components that you must consider for your release of Genesys Info Mart.

**Table 135: Supporting Software Components**

| Component                                         | Genesys Info Mart Release |       |       |       |                  |
|---------------------------------------------------|---------------------------|-------|-------|-------|------------------|
|                                                   | 7.0.1                     | 7.0.2 | 7.2.x | 7.5.x | 7.6.x            |
| <b>Operating Systems and Third-Party Software</b> |                           |       |       |       |                  |
| Operating system for Genesys Info Mart            | Yes                       | Yes   | Yes   | Yes   | Yes              |
| Operating system for Data Integrator              | Yes                       | Yes   | Yes   |       |                  |
| Browser software for Data Integrator              | Yes                       | Yes   | Yes   |       |                  |
| JRE/JDK for Genesys Info Mart                     | Yes                       | Yes   | Yes   | Yes   | Yes              |
| JRE/JDK for Data Integrator                       | Yes                       | Yes   | Yes   |       |                  |
| JDBC Driver                                       |                           |       | Yes   | Yes   | Yes              |
| <b>Data Source RDBMS (Server and Client)</b>      |                           |       |       |       |                  |
| Configuration Database                            | Yes                       | Yes   | Yes   |       |                  |
| Call Concentrator Database                        | Yes                       | Yes   | Yes   |       |                  |
| Interaction Database                              |                           |       | Yes   | Yes   | Yes              |
| Stat Server Database                              | Yes                       | Yes   | Yes   | Yes   | Yes <sup>a</sup> |
| GVP VAR Database                                  |                           |       |       | Yes   | Yes              |
| <b>Target RDBMS (Server and Client)</b>           |                           |       |       |       |                  |
| Data Integrator Local Repository                  | Yes                       | Yes   | Yes   |       |                  |

**Table 135: Supporting Software Components (Continued)**

| Component             | Genesys Info Mart Release |       |       |       |       |
|-----------------------|---------------------------|-------|-------|-------|-------|
|                       | 7.0.1                     | 7.0.2 | 7.2.x | 7.5.x | 7.6.x |
| Staging Area Database | Yes                       | Yes   | Yes   | Yes   | Yes   |
| Info Mart Database    | Yes                       | Yes   | Yes   | Yes   | Yes   |

a. For backward compatibility with legacy reporting environments only.

## Recommendations

You must consider the following recommendations for the supporting software components if applicable to your release of Genesys Info Mart:

- Operating Systems on which you will install the Data Integrator and Genesys Info Mart components. See *Genesys Supported Operating Environment Reference Manual* for more information.
- Browser software you use to communicate with Data Integrator. See *Genesys Supported Operating Environment Reference Manual* for more information.

---

**Note:** Starting with release 7.5, Genesys Info Mart does not require Data Integrator.

---

- Java Runtime Environment (JRE), Java Development Kit (JDK), and Java Database Connectivity (JDBC) driver that Data Integrator and Genesys Info Mart use. For more information, see the section about software requirements in the *Genesys Info Mart Deployment Guide*.
- Relational Database Management System (RDBMS) software:
  - Database servers that contain Genesys application data (Configuration Server, Call Concentrator, Interaction Concentrator, Stat Server, and Genesys Voice Platform [GVP] Voice Application Reporter [VAR] databases).
  - Database servers that contain Genesys Info Mart data (Data Integrator Local Repository, Staging Area, and Info Mart databases).
  - Database client software that the Data Integrator Designer, Job Server, and Genesys Info Mart use to access the Local Repository, Configuration Server, Call Concentrator, Interaction Concentrator, Stat Server, GVP VAR, and Staging Area and Info Mart databases. (With the exception of Genesys Info Mart Administration Console, Genesys Info Mart does not use Genesys DB Server to access databases.)

---

**Note:** Genesys recommends that you install the same versions of the RDBMS client and server components. Consult your RDBMS vendor for information about client/server interoperability.

---

For more information, see *Genesys Supported Operating Environment Reference Manual*.

Review the planning chapter in the *Genesys Info Mart Deployment Guide*, for an overview of the product architecture, and a list of Genesys applications and components that interact with Genesys Info Mart. See the *Genesys 7 Interoperability Guide* for information on the compatibility of Genesys products with various Configuration Layer Environments; Interoperability of Reporting Templates and Solutions; and *Gplus* Adapters Interoperability.

---

## Genesys Info Mart Migration Matrix

When you are migrating Genesys Info Mart from an earlier release to a later release, you may be able to do so in one stage (as, for example, with migration from release 7.5 to 7.6) or your migration may involve two or more stages (as, for example, with migration from release 7.2 to 7.6.x).

Use [Table 136](#) for a quick reference to all of the stages that are necessary for migration from your current Genesys Info Mart release to the target release.

---

**Notes:** You can migrate to the currently shipping version in each 7.x.x target release.

For the list of specific 7.5.x releases from which you can migrate to release 7.6.x, see [page 810](#).

---

**Table 136: Genesys Info Mart Migration Matrix**

| Current Release | Target Release                                            |                                                                                                                                                                                      |                                                                                                                                                                                                                                                            |                                                                                                                                                                                                                                                                                                                                  |
|-----------------|-----------------------------------------------------------|--------------------------------------------------------------------------------------------------------------------------------------------------------------------------------------|------------------------------------------------------------------------------------------------------------------------------------------------------------------------------------------------------------------------------------------------------------|----------------------------------------------------------------------------------------------------------------------------------------------------------------------------------------------------------------------------------------------------------------------------------------------------------------------------------|
|                 | 7.0.2                                                     | 7.2.x                                                                                                                                                                                | 7.5.x                                                                                                                                                                                                                                                      | 7.6.x                                                                                                                                                                                                                                                                                                                            |
| <b>7.0.1</b>    | Migrating Genesys Info Mart from 7.0.1 to 7.0.2, page 851 | <ol style="list-style-type: none"> <li>1. Migrating Genesys Info Mart from 7.0.1 to 7.0.2, page 851</li> <li>2. Migrating Genesys Info Mart from 7.0.2 to 7.2.x, page 837</li> </ol> | <ol style="list-style-type: none"> <li>1. Migrating Genesys Info Mart from 7.0.1 to 7.0.2, page 851</li> <li>2. Migrating Genesys Info Mart from 7.0.2 to 7.2.x, page 837</li> <li>3. Migrating Genesys Info Mart from 7.2.x to 7.5.x, page 829</li> </ol> | <ol style="list-style-type: none"> <li>1. Migrating Genesys Info Mart from 7.0.1 to 7.0.2, page 851</li> <li>2. Migrating Genesys Info Mart from 7.0.2 to 7.2.x, page 837</li> <li>3. Migrating Genesys Info Mart from 7.2.x to 7.5.x, page 829</li> <li>4. Migrating Genesys Info Mart from 7.5.x to 7.6.x, page 810</li> </ol> |
| <b>7.0.2</b>    |                                                           | Migrating Genesys Info Mart from 7.0.2 to 7.2.x, page 837                                                                                                                            | <ol style="list-style-type: none"> <li>1. Migrating Genesys Info Mart from 7.0.2 to 7.2.x, page 837</li> <li>2. Migrating Genesys Info Mart from 7.2.x to 7.5.x, page 829</li> </ol>                                                                       | <ol style="list-style-type: none"> <li>1. Migrating Genesys Info Mart from 7.0.2 to 7.2.x, page 837</li> <li>2. Migrating Genesys Info Mart from 7.2.x to 7.5.x, page 829</li> <li>3. Migrating Genesys Info Mart from 7.5.x to 7.6.x, page 810</li> </ol>                                                                       |
| <b>7.2.x</b>    |                                                           |                                                                                                                                                                                      | Migrating Genesys Info Mart from 7.2.x to 7.5.x, page 829                                                                                                                                                                                                  | <ol style="list-style-type: none"> <li>1. Migrating Genesys Info Mart from 7.2.x to 7.5.x, page 829</li> <li>2. Migrating Genesys Info Mart from 7.5.x to 7.6.x, page 810</li> </ol>                                                                                                                                             |
| <b>7.5.x</b>    |                                                           |                                                                                                                                                                                      |                                                                                                                                                                                                                                                            | Migrating Genesys Info Mart from 7.5.x to 7.6.x, page 810                                                                                                                                                                                                                                                                        |

---

## Reference Materials

Refer to the following reference materials when planning your Genesys Info Mart migration. Make sure you use the appropriate release-specific version of each document.

- *Genesys Info Mart 7.x Deployment Guide*
- *Genesys Info Mart 7.x Operations Guide*
- *Genesys Info Mart 7.x Reference Manual* for your DB2, Microsoft SQL Server, or Oracle database
- *Genesys Info Mart 7.x Database Size Estimator*
- *Genesys Info Mart 7.x Release Notes and Release Advisory*
- *Genesys Licensing Guide*
- *Genesys Supported Operating Environment Reference Manual*
- *Genesys 7 Interoperability Guide*
- *Genesys 8 Interoperability Guide*
- *Genesys 7 Hardware Sizing Guide*
- *Interaction Concentrator 7.x Deployment Guide*
- *Interaction Concentrator 7.6 User's Guide* (new in release 7.6)







## Chapter

# 47

## Changes in Genesys Info Mart 7.x

This section describes the changes in Genesys Info Mart's capabilities, configuration options, and database schema from one release to the next. For complete information about Genesys Info Mart, refer to the technical publications listed in “Reference Materials” on [page 763](#).

This chapter contains the following sections:

- [Content Changes in Genesys Info Mart 7.6, page 766](#)
- [Content Changes in Genesys Info Mart 7.5, page 770](#)
- [Content Changes in Genesys Info Mart 7.2, page 772](#)
- [Content Changes in Genesys Info Mart 7.0.2, page 774](#)
- [Configuration Option Changes in Genesys Info Mart 7.6, page 775](#)
- [Configuration Option Changes in Genesys Info Mart 7.5, page 781](#)
- [Configuration Option Changes in Genesys Info Mart 7.2, page 786](#)
- [Configuration Option Changes in Genesys Info Mart 7.0.2, page 791](#)
- [Schema Changes in the Info Mart Database 7.6, page 792](#)
- [Schema Changes in the Info Mart Database 7.5, page 797](#)
- [Schema Changes in the Info Mart Database 7.2, page 800](#)
- [Schema Changes in the Info Mart Database 7.0.2, page 807](#)

# Content Changes in Genesys Info Mart 7.6

**Notes:** Genesys Info Mart 7.6 is considered a major software release that contains many functional enhancements.

Genesys *strongly* recommends that you carefully plan your migration and practice migrating to Genesys Info Mart 7.6 in a non-production environment *before* performing the migration in your production environment.

If you choose to enable some of the new functionality that requires Interaction Concentrator 7.6, do not create a new `ICON Application` object in the Configuration Layer when upgrading Interaction Concentrator. Instead, use the existing `Application` in the Configuration Layer when you install the Interaction Concentrator upgrade. Refer to the *Genesys Info Mart 7.6 Operations Guide* for details.

## New Functionality

Genesys Info Mart 7.6 provides the following new functionality or changed functionality:

- Provides a new ETL job, `Job_MigrateGIM`, to migrate the data from the Staging Area and Genesys Info Mart databases of release 7.5 to release 7.6.
- Extracts voice agent state and reason details from Interaction Database (IDB), instead of from Stat Server. New Info Mart fact tables store details about states, reasons, and do-not-disturb (DND) modes for voice and Multimedia.

**Note:** For backward compatibility with deployments of earlier Genesys Info Mart releases only, Genesys Info Mart continues to provide data extraction of voice agent state and reason details from the Stat Server database.

- Provides high availability (HA) data extraction for voice agent login session, state and state reason, and DND mode details, which are extracted from an IDB that is populated by Interaction Concentrator (ICON) release 7.6 that has been configured appropriately. (T-Server release 7.6 is required.)
- Loads Open Media interaction and agent activity details from an IDB into the Info Mart database, in an environment with release 7.6 of Interaction Concentrator and Interaction Server. (*Open Media* refers to a custom media channel that is supported on top of Genesys Multimedia. The `Workitem` media type is an example of Open Media.)
- Loads active Multimedia virtual queue details into the Info Mart database, and links virtual queue details to their corresponding target Multimedia interaction segment details.

- Loads active Multimedia chat interactions into the Info Mart database. Previously, only completed chat interactions were loaded into the Info Mart database.
- Provides HA data extraction for contact center configuration history details, which are extracted from IDBs that are populated by ICON release 7.6.
- Extracts data from IDB following the use of the Interaction Concentrator feature for resynchronization of configuration data.
- Provides data-quality improvements in HA data extraction for voice interaction details by comparing voice interaction data between the IDBs that constitute the HA pair.
- Provides detailed reasons for interactions that are cleared from a virtual queue, such as:
  - Target is cleared by routing strategy.
  - Interaction is routed by another, parallel virtual queue.
  - Interaction is default-routed by strategy.
  - Multimedia interaction is pulled back from strategy due to timeout.

---

**Notes:** The support for all four clearance scenarios requires an environment with 7.6 releases of both Universal Routing Server and Interaction Concentrator that has been configured appropriately.

In addition, the fourth clearance scenario requires Interaction Server release 7.6 to report when a Multimedia interaction is cleared from a virtual queue or pulled from a routing strategy because it was not routed within the timeout configured for routing in Interaction Server.

- 
- Provides uninterrupted durations for *After Call Work (ACW)* (for voice only) and *Not Ready* states, when interactions are initiated or received while in these states, in an environment with Interaction Concentrator release 7.6 that has been configured appropriately.

---

**Note:** For voice, the newly introduced fact tables in release 7.6 contain the data for this feature; the data is not available in the legacy fact tables that are implemented in previous releases.

- 
- Provides data to calculate the number of voice interactions that are initiated or received while the agent is in *ACW* (voice only) or *Not Ready* states, in an environment with Interaction Concentrator release 7.6 that has been configured appropriately.

---

**Note:** For voice, the newly introduced fact tables in release 7.6 contain the data for this feature; the data is not available in the legacy fact tables that are implemented in previous releases.

---

- Associates ACW with the ACD or routed call, instead of with a consultation call, for the case in which the consultation call outlasts the original inbound customer call, in an environment with Interaction Concentrator release 7.6 that has been configured appropriately.
- Provides data to measure agent-to-agent consult talk duration, even if the consultation included an Interactive Voice Response (IVR) application or voice treatment port before the target agent answered the consultation.

---

**Note:** The newly introduced fact tables in release 7.6 contain the data for this feature; the data is not available in the legacy fact tables that are implemented in previous releases.

---

- Provides a set of new agent and interaction summary tables that facilitate aggregation for agent state and inbound voice interaction reporting.
- Provides several new interval-based and disposition-based aggregates, for use with either Genesys Interactive Insights (GI2) or your own custom reports.
- Provides configurable control of transaction sizes for data that is loaded in, aggregated in, and purged from the Info Mart database. This functionality provides improved capability for customers to control the database resources that are required to run the ETL jobs.
- Starting with Genesys Info Mart release 7.6.004, provides the ability to extract UserEvent-based key-value pair (KVP) data that is sent within a configurable timeout after the associated voice interaction ends.
- Starting with Genesys Info Mart release 7.6.004, provides the ability, at your option, to include the last five minutes of extracted voice agent activity data when transforming data in a simple contact center environment. This functionality improves the accuracy of agent reports for a given business day in a contact center that operates less than 24 hours a day. (A *simple* contact center is the one where an agent only logs in to a single switch, DN, or queue at a time, and where reporting requirements do *not* include the factoring of Do-Not-Disturb [DND] mode into summarized resource states and resource state reasons.)
- Starting with Genesys Info Mart release 7.6.005, provides enhanced support for reporting tools such as GI2 to report on:
  - Additional categories of calls.
  - The business attributes assigned to interactions from queues.
  - Inbound interactions that had a defined Baseline Service Objective and were offered to a resource.
  - The number of times inbound interactions were answered.

- Starting with Genesys Info Mart release 7.6.005, improves ETL performance by enabling you to specify the frequency with which the intraday aggregation portion of `Job_LoadRecent` will run.
- Starting with Genesys Info Mart release 7.6.005, supports a new Technical Descriptor combination that enables Genesys Info Mart to recognize and properly report the scenario when an agent pulls a Multimedia interaction from a strategy.
- Starting with Genesys Info Mart release 7.6.006, introduces a number of internal improvements to ETL algorithms and processes and to the database schemas to improve Genesys Info Mart performance in large-scale, inbound voice contact centers. Improvement in ETL performance was observed during testing in large-scale, inbound voice deployments using Oracle 10 and running the ETL on either Solaris 10 or Windows 2003.

New configuration options control those performance enhancements that are not relevant for smaller-scale contact centers or that modify existing functionality. The default settings of the new options maintain compatibility with existing deployments.

To further enhance scalability, Genesys Info Mart release 7.6.006 extends native operating system support to include 64-bit Solaris 10 and 64-bit Windows 2003 operating systems.

In addition to the performance enhancements that are intended for large-scale deployments, Genesys Info Mart release 7.6.006 improves ETL performance and reduces database storage requirements by optionally enabling you to:

- Disable the storage of voice Interaction Segment Facts.
- Reduce the number of days that data must be stored, before it can be purged.
- Limit automatic aggregation to a configured time range.
- Automatically ignore unresolved references to configuration objects when running ETL jobs.
- Starting with Genesys Info Mart release 7.6.006, optionally enables you to populate a separate row in the `INTERACTION_RESOURCE_FACT` table for data, including user data, associated with the consultation initiation segment of an interaction (resource role is `INITIATEDCONSULT`).

---

**Note:** Genesys Info Mart 7.6 does not support the Transport Layer Security (TLS) protocol feature that was introduced in the 7.5 release of other Genesys components.

---

### Technical Descriptor Key Changes

In Genesys Info Mart release 7.6.003, modifications were made to `technical_descriptor` dimension keys. As a result, technical descriptor keys for two rows in release 7.6.003 differ from those in release 7.5.005.05 or a later 7.5 release. When you run `Job_MigrateGIM` as part of the non-critical data

migration, the job will re-assign the keys and adjust all impacted fact table rows that refer to the related dimension rows.

If you are migrating from release 7.5.005.05 or a later 7.5 release, you need to analyze and make your own adjustments to any custom fact, summary, or aggregate tables that you built using keys from the two affected rows.

[Table 137](#) provides the two rows that this change affects.

**Table 137: Technical Descriptor Dimension Key Changes**

| TECHNICAL_DESCRIPTOR_KEY |                        | RESOURCE_ROLE_CODE | ROLE_REASON_CODE | TECHNICAL_RESULT_CODE | RESULT_REASON_CODE |
|--------------------------|------------------------|--------------------|------------------|-----------------------|--------------------|
| Old Value <sup>a</sup>   | New Value <sup>b</sup> |                    |                  |                       |                    |
| 102                      | 140                    | INCONFERENCE       | CONFERENCEJOINED | REDIRECTED            | ROUTEONNOANSWER    |
| 103                      | 141                    | INCONFERENCE       | CONFERENCEJOINED | REDIRECTED            | UNSPECIFIED        |

a. In Genesys Info Mart release 7.5.005

b. Starting from Genesys Info Mart release 7.6.003

**Discontinued Support**

- Genesys Info Mart 7.6 does not discontinue support for any component interfaces or 7.5 functionality.

---

**Note:** Refer to the *Genesys Info Mart 7.6 Deployment Guide* for instructions on how to enable new 7.6 functionality after you complete your migration.

---

## Content Changes in Genesys Info Mart 7.5

---

**Note:** Genesys Info Mart 7.5 is considered a major software release that contains many architectural changes and functional enhancements. Genesys *strongly* recommends that you carefully plan and practice migrating to Genesys Info Mart 7.5 in a non-production environment *before* performing the migration in your production environment.

It is important that you also test the population of new data in your non-production environment, to ensure compatibility with your current reporting application SQL queries. This is particularly important for Genesys Info Mart facts and dimensions that are populated from attached data key-value pairs extracted from Interaction Concentrator data sources.

---

**New Functionality** Genesys Info Mart 7.5 provides the following new functionality:

- Extracts contact center configuration history details from Interaction Database 7.5, rather than from Configuration Server 7.
- Extracts voice interaction and attached data details from one or more Interaction Database(s) 7.5, rather than from Call Concentrator. This provides improved multi-site interaction data population.
- Extracts voice resource login/logout details from Interaction Database 7.5, rather than from Stat Server 7. To ensure backward compatibility, voice resource state and resource state reasons details are still extracted from Stat Server 7.
- Loads virtual queue details into the Info Mart database (extracted from Interaction Database 7.5). These details enable virtual queue reporting based on:
  - The result and duration of the distribution attempt from the perspective of the virtual queue (such as `Diverged`, `Cleared`, or `Abandoned`).
  - The result and duration of the distribution attempt from the perspective of the target resource (such as `AnsweredbyAgent`, `AnsweredbyOther`, `Redirected`, or `AbandonedWhileRingin`). These details are supported for voice interactions only.
  - The talk, hold and after-call-work (ACW) durations associated with the calls that were distributed from the virtual queue. This type of reporting is enabled for voice interactions only, and requires a reporting specialist to develop custom SQL queries.
- Loads Multimedia solution (e-mail and chat) interaction details into the Info Mart database (extracted from Interaction Database 7.5).
- Loads Multimedia resource login/logout, resource state and resource state reasons details (extracted from Interaction Database 7.5).
- Loads Multimedia interaction details, Multimedia resource state and resource state reason details, and network routing solution voice interactions into the Info Mart database (extracted from Interaction Database 7.5).
- Loads voice application details into the Info Mart database (extracted from the Genesys Voice Platform Voice Application Platform (GVP VAR) 7.5 database).
- Improves data population for multi-site interactions. Performs intra-IDB and multi-IDB merge on voice interaction data extracted from multiple ICON databases.
- Supports high availability (HA) deduplication for voice interactions, attached data, and virtual queue details from a HA IDB pair.
- Replaces Business Objects Data Integrator with a proprietary Java-based extraction, transformation, and loading (ETL) process.

- Includes the Genesys Info Mart Administration Console, a non-Java-based application that you can use to monitor ETL job status and, when necessary, start or stop ETL jobs outside of the normal schedule.
- Supports several new operating system versions and relational database management system (RDBMS) versions.

**Discontinued Support**

Genesys Info Mart 7.5 no longer uses, supports, or interfaces with the following components:

- Genesys License Server—Technical licenses are no longer required.
- Configuration Server database—Genesys Info Mart 7.5 extracts contact center configuration details from Interaction Database.
- Call Concentrator 7 database(s)—Genesys Info Mart 7.5 extracts voice interactions and attached data from Interaction Database.
- Business Objects Data Integrator (including the Local Repository database, Job Server, Web Administrator Server, Designer, Web Administrator, Repository Manager and Job Server Manager).
- Genesys Info Mart 7.5 replaces Business Objects Data Integrator with the Genesys Info Mart Server component.
- JOB\_ExtractCFG—Genesys Info Mart 7.5 uses Job\_ExtractICON to extract the contact center configuration details.
- JOB\_ExtractCCON —Genesys Info Mart 7.5 uses Job\_ExtractICON to extract voice interaction and attached data details.
- The Audit dimension—Does not support the DATA\_COLLISION\_FLAG for HA IDBs.

---

**Note:** Genesys Info Mart 7.5 does not support the Transport Layer Security (TLS) protocol feature that was introduced in the 7.5 release of other Genesys components.

---

## Content Changes in Genesys Info Mart 7.2

Genesys Info Mart 7.2 provides the following new capabilities and options:

- New Functionality**
- **Intraday loading**—Genesys Info Mart 7.2 supplies separate intraday and historical tables. The ETL loads the intraday fact and aggregate tables frequently during the day. Once a day, generally overnight, the ETL moves data from the intraday fact tables to their counterpart historical fact tables, then updates the historical aggregate tables based on the newly loaded historical facts. A new ETL job, JOB\_LoadRecent, provides intraday loading functionality.



- **Simplified job scheduling**—Genesys Info Mart Server is a new software application that launches the ETL jobs based on the schedule you configure in Configuration Sever. It also manages ETL job interdependencies. Although Genesys Info Mart Server is the application that normally launches ETL jobs, you still use Data Integrator Web Administrator to run or schedule jobs for error recovery. You can use Genesys Solution Control 7.x to start and stop Genesys Info Mart Server.
- **Pre-defined aggregates**—Genesys Info Mart 7.2 optionally populates pre-defined skill-based interaction and resource aggregates. The CCPulse+ 7.2 inbound voice reporting templates use these aggregates. Your custom reporting applications can also use these aggregates. New ETL jobs, JOB\_LoadRecent and JOB\_AggregateGIM provide aggregation functionality.
- **Resource state reasons**—Genesys Info Mart 7.2 optionally populates work modes and reason codes for ready, not ready and after call work DN states in its RESOURCE\_STATE\_REASON\_FACT table. Both hardware and software reasons are supported. Source data is extracted from Stat Server 7.2's VOICE\_REASONS database table.
- **Outbound Contact Solution data**—Genesys Info Mart 7.2 optionally populates campaign configuration, campaign session, calling list metrics, and outbound contact attempt information in new fact and dimension tables. Source data is extracted from Configuration Server and Interaction Concentrator 7.2's OCS extension tables. A new ETL job, JOB\_ExtractICON, provides the extraction functionality.
- **Active login sessions**—Genesys Info Mart 7.2 populates both active and completed login sessions in its RESOURCE\_SESSION\_FACT table. Previous versions of the product populated only completed login sessions.
- **Virtual agent group membership**—Genesys Info Mart 7.2 populates skill expression-based virtual agent group membership in its RESOURCE\_GROUP\_FACT table. Source data is extracted from Configuration Server 7.2's database.
- **Business Objects Data Integrator 11**—Genesys Info Mart 7.2 uses Data Integrator version 11. This version of Data Integrator, which ships with Genesys Info Mart 7.2, supports new operating systems and RDBMS versions.
- **Info Mart database enhancements**—In addition to the enhancements listed above, Genesys Info Mart 7.2 supplies other additions and enhancements to the Info Mart database.

---

# Content Changes in Genesys Info Mart 7.0.2

Genesys Info Mart 7.0.2 provides the following new capabilities and options:

- New Functionality**
- **Improved performance**—Dramatically improved performance (allowing up to 1,000,000 interactions per day to be loaded into the Info Mart database). To accomplish this, the Genesys Info Mart ETL jobs have been restructured to allow multiple data extractions and multiple data transformations per day. Data is loaded into the Info Mart database once a day, generally at the end of the day.
  - **Support for mixed-database environments**—The DBMS type of the Configuration Server database can be Microsoft SQL Server regardless of whether the source and target databases are Microsoft SQL Server, DB2, or Oracle.
  - **Improved data management and auditing**—Facilitates Info Mart’s maintenance by database administrators and support by Genesys:
    - The new Audit dimension in the Info Mart database indicates what type of source system provided the data—Configuration Server, Call Concentrator, Stat Server, or Info Mart itself— and the specific instance of that source system.
    - Within the Info Mart database, the fact and dimension tables contain new timestamps to facilitate the identification of new and changed data.
    - Within the Info Mart database, the fact extension tables contain new fields that facilitate partitioning by date.
    - New Staging Area database views provide a history about each completed ETL process.
    - Enhanced Info Mart purging rules, to provide database administrators with greater control and flexibility over the time and method used to delete old table data. Specifically, Genesys Info Mart can be configured to “flag” rows that are eligible for purging, rather than delete them.
  - **Reorganized configuration options within Configuration Manager**—Permits tenants in a multi-tenant deployment to modify their own configuration.
  - **Business Objects Data Integrator 6.5.1**—Improves ETL performance and reliability.

## Configuration Option Changes in Genesys Info Mart 7.6

Table 138 lists the changes in the Genesys Info Mart configuration options between releases 7.5.x and 7.6.x. For your convenience, the configuration sections are listed in alphabetical order, as are the options for each section. For more detailed descriptions of these options, see the section about configuring Genesys Info Mart in the *Genesys Info Mart 7.6 Deployment Guide*.

**Table 138: Configuration Option Changes from 7.5.x to 7.6.x**

| Section               | Option Name                                    | Change Type   | Changed in Release | Details                                                                                                                                                                                                       |
|-----------------------|------------------------------------------------|---------------|--------------------|---------------------------------------------------------------------------------------------------------------------------------------------------------------------------------------------------------------|
| custom-data           | extract-user-event-data                        | Option added. | 7.6.004            |                                                                                                                                                                                                               |
| custom-data           | user-event-data                                | Option added. | 7.6.004            | This option can be configured only in the <code>Application</code> object for the Database Access Point (DAP) through which voice interaction data is extracted (the role is set to <code>ICON_CORE</code> ). |
| custom-data           | user-event-data-timeout                        | Option added. | 7.6.004            |                                                                                                                                                                                                               |
| gim-aggregates-tenant | days-to-keep-day-level-disposition-aggregates  | Option added. | 7.6                |                                                                                                                                                                                                               |
| gim-aggregates-tenant | days-to-keep-day-level-interval-aggregates     | Option added. | 7.6                |                                                                                                                                                                                                               |
| gim-aggregates-tenant | days-to-keep-hour-level-disposition-aggregates | Option added. | 7.6                |                                                                                                                                                                                                               |
| gim-aggregates-tenant | days-to-keep-hour-level-interval-aggregates    | Option added. | 7.6                |                                                                                                                                                                                                               |

**Table 138: Configuration Option Changes from 7.5.x to 7.6.x (Continued)**

| Section                        | Option Name                                                             | Change Type    | Changed in Release | Details |
|--------------------------------|-------------------------------------------------------------------------|----------------|--------------------|---------|
| gim-aggregates-tenant          | days-to-keep-month-level-disposition-aggregates                         | Option added.  | 7.6                |         |
| gim-aggregates-tenant          | days-to-keep-subhour-level-interval-aggregates                          | Option added.  | 7.6                |         |
| gim-aggregates-tenant          | max-late-arriving-fact-time-limit                                       | Option added.  | 7.6.006            |         |
| gim-aggregates-tenant          | populate-agent-state-interval-aggregates                                | Option added.  | 7.6                |         |
| gim-aggregates-tenant          | populate-ixn-agent-aggregates                                           | Option added.  | 7.6                |         |
| gim-aggregates-tenant          | populate-ixn-agent-interval-aggregates                                  | Option added.  | 7.6                |         |
| gim-aggregates-tenant          | populate-ixn-service-type-aggregates                                    | Option added.  | 7.6                |         |
| gim-aggregates-tenant          | populate-queue-aggregates                                               | Option added.  | 7.6                |         |
| gim-aggregates-tenant          | short-talk-threshold                                                    | Option added.  | 7.6.005            |         |
| gim-agg-voice-abandon-tenant   |                                                                         | Section added. | 7.6                |         |
| gim-agg-voice-abandon-tenant   | abandon-duration-range-01-thold through abandon-duration-range-19-thold | Options added. | 7.6                |         |
| gim-agg-voice-init-resp-tenant |                                                                         | Section added. | 7.6                |         |

**Table 138: Configuration Option Changes from 7.5.x to 7.6.x (Continued)**

| Section                        | Option Name                                                                 | Change Type    | Changed in Release | Details                                                  |
|--------------------------------|-----------------------------------------------------------------------------|----------------|--------------------|----------------------------------------------------------|
| gim-agg-voice-init-resp-tenant | init-resp-duration-range-01-thold through init-resp-duration-range-19-thold | Options added. | 7.6                |                                                          |
| gim-etl                        | aggregate-time-range-limit                                                  | Option added.  | 7.6                |                                                          |
| gim-etl                        | aggregate-time-range-units                                                  | Option added.  | 7.6                |                                                          |
| gim-etl                        | data-migration-time-range-limit                                             | Option added.  | 7.6                |                                                          |
| gim-etl                        | data-migration-time-range-units                                             | Option added.  | 7.6                |                                                          |
| gim-etl                        | days-to-keep-stg-icon-call-info                                             | Option added.  | 7.6.003            |                                                          |
| gim-etl                        | default-ivr-to-self-service                                                 | Option added.  | 7.6                |                                                          |
| gim-etl                        | extract-ha-voice-agent-activity                                             | Option added.  | 7.6                |                                                          |
| gim-etl                        | factor-dnd-into-sm-resource-states                                          | Option added.  | 7.6                | This option can be configured only in the Switch object. |
| gim-etl                        | ha-agent-all-connections-required                                           | Option added.  | 7.6                |                                                          |
| gim-etl                        | ha-cfg-all-connections-required                                             | Option added.  | 7.6                |                                                          |
| gim-etl                        | ha-ir-extract-comparison-timeout                                            | Option added.  | 7.6                |                                                          |
| gim-etl                        | ir-merge-interval                                                           | Value added.   | 7.6.003            | -1 is added to the list of valid values.                 |

**Table 138: Configuration Option Changes from 7.5.x to 7.6.x (Continued)**

| Section | Option Name                              | Change Type   | Changed in Release | Details |
|---------|------------------------------------------|---------------|--------------------|---------|
| gim-etl | load-transaction-size                    | Option added. | 7.6                |         |
| gim-etl | maintain-time-range-limit                | Option added. | 7.6                |         |
| gim-etl | maintain-time-range-units                | Option added. | 7.6                |         |
| gim-etl | populate-detailed-ixn-subtype            | Option added. | 7.6                |         |
| gim-etl | populate-dt-chat-resource-activity       | Option added. | 7.6                |         |
| gim-etl | populate-dt-email-resource-activity      | Option added. | 7.6                |         |
| gim-etl | populate-dt-open-media-resource-activity | Option added. | 7.6                |         |
| gim-etl | populate-dt-voice-resource-activity      | Option added. | 7.6                |         |
| gim-etl | populate-open-media-ixns                 | Option added. | 7.6                |         |
| gim-etl | populate-open-media-resource-activity    | Option added. | 7.6                |         |
| gim-etl | populate-sm-chat-resource-activity       | Option added. | 7.6                |         |
| gim-etl | populate-sm-email-resource-activity      | Option added. | 7.6                |         |
| gim-etl | populate-sm-open-media-resource-activity | Option added. | 7.6                |         |
| gim-etl | populate-sm-voice-resource-activity      | Option added. | 7.6                |         |

**Table 138: Configuration Option Changes from 7.5.x to 7.6.x (Continued)**

| Section            | Option Name                               | Change Type           | Changed in Release | Details                                                                  |
|--------------------|-------------------------------------------|-----------------------|--------------------|--------------------------------------------------------------------------|
| gim-etl            | populate-voice-init-consult-in-irf        | Option added.         | 7.6.006            |                                                                          |
| gim-etl            | populate-voice-ixn-seg-facts              | Option added.         | 7.6.006            |                                                                          |
| gim-etl            | populate-voice-resource-states-for-queues | Option added.         | 7.6                |                                                                          |
| gim-etl            | q-answer-threshold-mm                     | Option added.         | 7.6                | This option can also be configured in the DN objects for virtual queues. |
| gim-etl            | sm-resource-state-priority                | Option added.         | 7.6                |                                                                          |
| gim-etl            | sub-hour-level-aggregation                | Option added.         | 7.6                |                                                                          |
| gim-etl-tenant     | days-to-keep-dt-resource-activity-facts   | Option added.         | 7.6                | This option can also be configured in tenant objects.                    |
| gim-etl-tenant     | days-to-keep-dt-resource-activity-facts   | Valid values changed. | 7.6.006            | The minimum valid value is changed from 30 to 3.                         |
| gim-etl-tenant     | days-to-keep-gim-facts                    | Valid values changed. | 7.6.006            | The minimum valid value is changed from 30 to 3.                         |
| gim-transformation | complex-voice-agent-env                   | Option added.         | 7.6.004            |                                                                          |
| gim-transformation | ignore-missing-config-objs                | Option added.         | 7.6.006            |                                                                          |
| gim-tuning         |                                           | Section added.        | 7.6.006            |                                                                          |
| gim-tuning         | aggregate-tenants-in-parallel             | Option added.         | 7.6.006            |                                                                          |
| gim-tuning         | extract-agent-activity-data-in-parallel   | Option added.         | 7.6.006            |                                                                          |

**Table 138: Configuration Option Changes from 7.5.x to 7.6.x (Continued)**

| Section         | Option Name                             | Change Type   | Changed in Release | Details |
|-----------------|-----------------------------------------|---------------|--------------------|---------|
| gim-tuning      | extract-ha-deduplicate-in-parallel      | Option added. | 7.6.006            |         |
| gim-tuning      | extract-merging-in-parallel             | Option added. | 7.6.006            |         |
| gim-tuning      | load-historical-tables-in-parallel      | Option added. | 7.6.006            |         |
| gim-tuning      | load-intraday-tables-in-parallel        | Option added. | 7.6.006            |         |
| gim-tuning      | lookup-caching-factor                   | Option added. | 7.6.006            |         |
| gim-tuning      | maintain-tables-in-parallel             | Option added. | 7.6.006            |         |
| gim-tuning      | maintain-tenants-in-parallel            | Option added. | 7.6.006            |         |
| gim-tuning      | max-tenants-in-parallel                 | Option added. | 7.6.006            |         |
| gim-tuning      | oracle-stats-degree-of-parallelism      | Option added. | 7.6.006            |         |
| gim-tuning      | run-gim-config-before-starting-job      | Option added. | 7.6.006            |         |
| optional-tables | populate-acd-queue-facts                | Option added. | 7.6                |         |
| optional-tables | populate-dt-dnd-facts                   | Option added. | 7.6                |         |
| optional-tables | populate-dt-resource-state-facts        | Option added. | 7.6                |         |
| optional-tables | populate-dt-resource-state-reason-facts | Option added. | 7.6                |         |



**Table 138: Configuration Option Changes from 7.5.x to 7.6.x (Continued)**

| Section         | Option Name                               | Change Type   | Changed in Release | Details |
|-----------------|-------------------------------------------|---------------|--------------------|---------|
| optional-tables | populate-interaction-resource-facts       | Option added. | 7.6                |         |
| optional-tables | populate-interaction-resource-state-facts | Option added. | 7.6                |         |
| optional-tables | populate-sm-resource-session-facts        | Option added. | 7.6                |         |
| optional-tables | populate-sm-resource-state-facts          | Option added. | 7.6                |         |
| optional-tables | populate-sm-resource-state-reason-facts   | Option added. | 7.6                |         |
| schedule        | intraday-aggregates-frequency             | Option added. | 7.6.005            |         |
| schedule        | migration-duration-in-hours               | Option added. | 7.6                |         |
| schedule        | migration-start-time                      | Option added. | 7.6                |         |
| schedule        | run-migration                             | Option added. | 7.6                |         |

## Configuration Option Changes in Genesys Info Mart 7.5

[Table 139](#) lists the changes in the Genesys Info Mart configuration options between releases 7.2.x and 7.5.x. For more detailed descriptions of these options, see the section about configuring Genesys Info Mart in the *Genesys Info Mart 7.5 Deployment Guide*.

**Table 139: Configuration Option Changes from 7.2.x to 7.5.x**

| Section                   | Option Name                    | Change Type      | Changed in Release | Details                                                                                                                                                                                 |
|---------------------------|--------------------------------|------------------|--------------------|-----------------------------------------------------------------------------------------------------------------------------------------------------------------------------------------|
| ccon-data-sources         |                                | Section removed. | 7.5                | This section is not used in Genesys Info Mart 7.5. In release 7.5, Genesys Info Mart uses Database Access Points (DAPs) to configure connections to Interaction Concentrator databases. |
| ccon-ha-pairs             |                                | Section removed. | 7.5                | This section is not used in Genesys Info Mart 7.5. In release 7.5, Genesys Info Mart uses Database Access Point options to configure ICON HA database pairs.                            |
| data-integrator-web-admin |                                | Section removed. | 7.5                | This section is not used in Genesys Info Mart 7.5.                                                                                                                                      |
| gim-etl                   | ccon-dup-scdr                  | Option removed.  | 7.5                | This option is no longer used.                                                                                                                                                          |
| gim-etl                   | days-to-keep-stg-dup-scdrs     | Option removed.  | 7.5                | This option is no longer used.                                                                                                                                                          |
| gim-etl                   | max-scdr-count                 | Option removed.  | 7.5                | This option is no longer used.                                                                                                                                                          |
| gim-etl                   | use-oracle-bulk-load           | Option removed.  | 7.5                | This option is no longer used. Genesys Info Mart 7.5 no longer uses bulk loading.                                                                                                       |
| gim-etl                   | zero-end-time-is-active-status | Option removed.  | 7.5                | This option is no longer used. Genesys Info Mart 7.5 requires Stat Server's <code>status-table-update-end-time-at-end-only</code> option to be set to True.                             |
| gim-etl                   | max-session-duration-in-hours  | Option changed.  | 7.5                | The default value of this option is now 24 (hours). Active resource sessions are always populated; a value of 0 is treated the same as the default (24).                                |

**Table 139: Configuration Option Changes from 7.2.x to 7.5.x (Continued)**

| Section | Option Name                   | Change Type   | Changed in Release | Details                                                                                                                                                                                                         |
|---------|-------------------------------|---------------|--------------------|-----------------------------------------------------------------------------------------------------------------------------------------------------------------------------------------------------------------|
| gim-etl | days-to-keep-stg-ha-ir-ids    | Option added. | 7.5                | This option specifies the number of days that the ETL retains IR IDs that it has extracted from one (only) of the Interaction Databases (IDBs) that constitute an HA pair.                                      |
| gim-etl | extract-data-after-date       | Option added. | 7.5                | This option specifies the starting data for extracted data.                                                                                                                                                     |
| gim-etl | extract-date-time-range-limit | Option added. | 7.5                | This option specifies the approximate time range of data that will be extracted in a single ETL cycle.                                                                                                          |
| gim-etl | extract-date-time-range-units | Option added. | 7.5                | This option specifies the units used for the <code>extract-date-time-range-limit</code> option.                                                                                                                 |
| gim-etl | ir-merge-interval             | Option added. | 7.5                | This option specifies the time interval, in minutes, at which the Genesys Info Mart Server will periodically run the IR Merge stored procedure on all configured DAPs with the role of <code>ICON_CORE</code> . |
| gim-etl | limit-extract-data            | Option added. | 7.5                | This option specifies the amount of data that Genesys Info Mart extracts and processes.                                                                                                                         |
| gim-etl | max-wrap-delay                | Option added. | 7.5                | This option specifies the number in seconds within which the agent must enter after-call-work (ACW) after the call ends.                                                                                        |

**Table 139: Configuration Option Changes from 7.2.x to 7.5.x (Continued)**

| Section            | Option Name                       | Change Type   | Changed in Release | Details                                                                                                                                                                              |
|--------------------|-----------------------------------|---------------|--------------------|--------------------------------------------------------------------------------------------------------------------------------------------------------------------------------------|
| gim-etl            | memory-threshold                  | Option added. | 7.5                | This option specifies the percentage of available memory that must be exceeded before Genesys Info Mart logs a message indicating that the memory threshold has been exceeded.       |
| gim-etl            | populate-chat-ixns                | Option added. | 7.5                | This option enables or disables Genesys Info Mart output of Multimedia chat interactions.                                                                                            |
| gim-etl            | populate-chat-resource-activity   | Option added. | 7.5                | This option enables or disables Genesys Info Mart output of Multimedia chat resource activity facts.                                                                                 |
| gim-etl            | populate-email-ixns               | Option added. | 7.5                | This option enables or disables Genesys Info Mart output of Multimedia e-mail interactions.                                                                                          |
| gim-etl            | populate-email-resource-activity  | Option added. | 7.5                | This option enables or disables Genesys Info Mart output of Multimedia e-mail resource activity facts.                                                                               |
| gim-etl            | q-answer-threshold-voice          | Option added. | 7.5                | This option specifies the global default duration, in seconds, used as a target time to answer for voice interactions that entered virtual queues.                                   |
| gim-etl            | q-short-abandoned-threshold-voice | Option added. | 7.5                | This option specifies the global duration, in seconds, used to indicate that a voice interaction that was abandoned while in a virtual queue should be considered a “short” abandon. |
| gim-transformation | show-conference-detail            | Option added. | 7.5                | This option controls how Genesys Info Mart populates the TECHNICAL_DESCRIPTOR dimension for voice interactions.                                                                      |

**Table 139: Configuration Option Changes from 7.2.x to 7.5.x (Continued)**

| Section             | Option Name                  | Change Type      | Changed in Release | Details                                                                                                                                  |
|---------------------|------------------------------|------------------|--------------------|------------------------------------------------------------------------------------------------------------------------------------------|
| gim-transformation  | transformation-buffer-size   | Option added.    | 7.5                | This option specifies the relative size of the buffer used to hold extracted data during the transformation process.                     |
| ixn-user-data-facts | user-data-16                 | Option added.    | 7.5                | This option specifies how User Data 16 is populated based on the specified value of the corresponding facts in the interaction segments. |
| ixn-user-data-facts | user-data-17                 | Option added.    | 7.5                | This option specifies how User Data 17 is populated based on the specified value of the corresponding facts in the interaction segments. |
| ixn-user-data-facts | user-data-18                 | Option added.    | 7.5                | This option specifies how User Data 18 is populated based on the specified value of the corresponding facts in the interaction segments. |
| ixn-user-data-facts | user-data-19                 | Option added.    | 7.5                | This option specifies how User Data 19 is populated based on the specified value of the corresponding facts in the interaction segments. |
| ixn-user-data-facts | user-data-20                 | Option added.    | 7.5                | This option specifies how User Data 20 is populated based on the specified value of the corresponding facts in the interaction segments. |
| license             |                              | Section removed. | 7.5                | This section is not used in Genesys Info Mart 7.5.                                                                                       |
| optional-tables     | populate-gvp-var-facts       | Option added.    | 7.5                | This option enables or disables Genesys Info Mart output to the GVP VAR fact and dimension tables.                                       |
| optional-tables     | populate-virtual-queue-facts | Option added.    | 7.5                | This option enables or disables Genesys Info Mart output to the VQ_SEGMENT_FACT table.                                                   |

**Table 139: Configuration Option Changes from 7.2.x to 7.5.x (Continued)**

| Section                  | Option Name    | Change Type                    | Changed in Release | Details                                                                                                                                                                                |
|--------------------------|----------------|--------------------------------|--------------------|----------------------------------------------------------------------------------------------------------------------------------------------------------------------------------------|
| stat-server-data-sources |                | Section removed.               | 7.5                | This section is not used in Genesys Info Mart 7.5. In release 7.5, Genesys Info Mart uses Database Access Points (DAPs) to configure connections to Stat Server databases.             |
| gim-etl                  | network-switch | Option added to Switch object. | 7.5                | This option identifies the Switch object as a network switch. The transformation process uses this option to determine which resources in the voice interaction are network resources. |

## Configuration Option Changes in Genesys Info Mart 7.2

Table 140 lists the changes to the Genesys Info Mart configuration options between releases 7.0.2 and 7.2. For more detailed descriptions of these options, see section about customizing your configuration in the *Genesys Info Mart 7.2 Deployment Guide*.

**Table 140: Configuration Option Changes from 7.0.2 to 7.2**

| Section                  | Option name   | Change Type              | Changed in Release | Details                                                                                                                                         |
|--------------------------|---------------|--------------------------|--------------------|-------------------------------------------------------------------------------------------------------------------------------------------------|
| ccon-data-sources        | <data-source> | Option dependency added. | 7.2                | The option name you choose for each Call Concentrator data source must match the system configuration you specify when you run JOB_ExtractCCON. |
| stat-server-data-sources | <data-source> | Option dependency added. | 7.2                | The option name you choose for each Stat Server data source must match the system configuration you specify when you run JOB_ExtractSS.         |

**Table 140: Configuration Option Changes from 7.0.2 to 7.2 (Continued)**

| Section                      | Option name                           | Change Type    | Changed in Release | Details                                                                                                                                   |
|------------------------------|---------------------------------------|----------------|--------------------|-------------------------------------------------------------------------------------------------------------------------------------------|
| data-integrator-web-admin    |                                       | Section added. | 7.2                | New section for specifying the options that Genesys Info Mart Server uses to communicate with Data Integrator's Web Administrator Server. |
| data-integrator-web-admin    | host-name                             | Option added.  | 7.2                |                                                                                                                                           |
| data-integrator-web-admin    | job-server-name                       | Option added.  | 7.2                |                                                                                                                                           |
| data-integrator-web-admin    | port                                  | Option added.  | 7.2                |                                                                                                                                           |
| data-integrator-web-admin    | system-config                         | Option added.  | 7.2                |                                                                                                                                           |
| gim-aggregates-tenant        |                                       | Section added. | 7.2                | New section to specify default tenant aggregation options.                                                                                |
| gim-aggregates-tenant        | populate-agent-state-aggregates       | Option added.  | 7.2                |                                                                                                                                           |
| gim-aggregates-tenant        | populate-skill-demand-aggregates      | Option added.  | 7.2                |                                                                                                                                           |
| gim-aggregates-tenant        | populate-skill-combination-aggregates | Option added.  | 7.2                |                                                                                                                                           |
| gim-aggregates-tenant        | maximum-aggregation-level             | Option added.  | 7.2                |                                                                                                                                           |
| gim-aggregates-tenant        | init-resp-duration-range-1-thold      | Option added.  | 7.2                |                                                                                                                                           |
| gim-agg-skill-inb-ixn-tenant |                                       | Section added. | 7.2                |                                                                                                                                           |

**Table 140: Configuration Option Changes from 7.0.2 to 7.2 (Continued)**

| Section                      | Option name                              | Change Type    | Changed in Release | Details                                          |
|------------------------------|------------------------------------------|----------------|--------------------|--------------------------------------------------|
| gim-agg-skill-inb-ixn-tenant | init-resp-duration-range-2-thold         | Option added.  | 7.2                |                                                  |
| gim-agg-skill-inb-ixn-tenant | init-resp-duration-range-3-thold         | Option added.  | 7.2                |                                                  |
| gim-agg-skill-abandon-tenant |                                          | Section added. | 7.2                |                                                  |
| gim-agg-skill-abandon-tenant | abandon-duration-range-1-thold           | Option added.  | 7.2                |                                                  |
| gim-agg-skill-abandon-tenant | abandon-duration-range-2-thold           | Option added.  | 7.2                |                                                  |
| gim-agg-skill-abandon-tenant | abandon-duration-range-3-thold           | Option added.  | 7.2                |                                                  |
| gim-etl                      | max-session-duration-in-hours            | Option added.  | 7.2                |                                                  |
| gim-etl                      | max-camp-group-session-duration-in-hours | Option added.  | 7.2                |                                                  |
| gim-etl                      | max-camp-group-state-duration-in-hours   | Option added.  | 7.2                |                                                  |
| gim-etl                      | populate-ocs-ixns                        | Option added.  | 7.2                |                                                  |
| gim-etl                      | zero-end-time-is-active-status           | Option added.  | 7.2                |                                                  |
| gim-transformation           |                                          | Section added. | 7.2                | New section for customizing ETL data population. |



**Table 140: Configuration Option Changes from 7.0.2 to 7.2 (Continued)**

| Section            | Option name                            | Change Type         | Changed in Release | Details                                  |
|--------------------|----------------------------------------|---------------------|--------------------|------------------------------------------|
| gim-transformation | show-abandoned-detail                  | Option added.       | 7.2                |                                          |
| gim-transformation | voice-init-resp-duration               | Option added.       | 7.2                |                                          |
| log                | verbose                                | Option value added. | 7.2                |                                          |
| optional-tables    | populate-resource-state-reason-facts   | Option added.       | 7.2                |                                          |
| schedule           |                                        | Section added.      | 7.2                | New section to specify ETL job schedule. |
| schedule           | run-scheduler                          | Option added.       | 7.2                |                                          |
| schedule           | etl-start-time                         | Option added.       | 7.2                |                                          |
| schedule           | etl-frequency                          | Option added.       | 7.2                |                                          |
| schedule           | etl-end-time                           | Option added.       | 7.2                |                                          |
| schedule           | load-recent-with-extract-and-transform | Option added.       | 7.2                |                                          |
| schedule           | populate-intraday-aggregates           | Option added.       | 7.2                |                                          |
| schedule           | run-maintain                           | Option added.       | 7.2                |                                          |
| schedule           | run-aggregates                         | Option added.       | 7.2                |                                          |
| schedule           | load-recent-start-time                 | Option added.       | 7.2                |                                          |

**Table 140: Configuration Option Changes from 7.0.2 to 7.2 (Continued)**

| Section         | Option name                 | Change Type                    | Changed in Release | Details                                                                                                                   |
|-----------------|-----------------------------|--------------------------------|--------------------|---------------------------------------------------------------------------------------------------------------------------|
| schedule        | load-start-time             | Option added.                  | 7.2                |                                                                                                                           |
| schedule        | aggregate-start-time        | Option added.                  | 7.2                |                                                                                                                           |
| schedule        | maintain-start-time         | Option added.                  | 7.2                |                                                                                                                           |
| schedule        | max-concurrent-extract-jobs | Option added.                  | 7.2                |                                                                                                                           |
| gim-etl-mapping |                             | Section added to Field object. | 7.2                | New section to specify Field object to Genesys Info Mart mapping.                                                         |
| gim-etl-mapping | table-name                  | Option added to Field object.  | 7.2                | See the section about configuring the mapping of the OCS record fields in the <i>Genesys Info Mart Deployment Guide</i> . |
| gim-etl-mapping | column-name                 | Option added to Field object.  | 7.2                | See the section about configuring the mapping of the OCS record fields in the <i>Genesys Info Mart Deployment Guide</i> . |
| default         | right_person                | Option added to Field object.  | 7.2                | See the section about configuring the mapping of the OCS record fields in the <i>Genesys Info Mart Deployment Guide</i> . |
| default         | conversion                  | Option added to Field object.  | 7.2                | See the section about configuring the mapping of the OCS record fields in the <i>Genesys Info Mart Deployment Guide</i> . |

## Configuration Option Changes in Genesys Info Mart 7.0.2

Table 141 lists the changes to the Genesys Info Mart configuration options between releases 7.0.1 and 7.0.2. For more detailed descriptions of these options, see the section about customizing your configuration in the *Genesys Info Mart 7.0.2 Deployment Guide*.

**Table 141: Configuration Option Changes from 7.0.1 and 7.0.2**

| Section                | Option name              | Change Type      | Changed in Release | Details                                               |
|------------------------|--------------------------|------------------|--------------------|-------------------------------------------------------|
| days-to-keep-gim-facts |                          | Section removed. | 7.0.2              | Options moved to gim-etl-tenant section               |
| gim-etl                | data-source-lag          | Option added.    | 7.0.2              |                                                       |
| gim-etl                | end-of-reporting-day     | Option removed.  | 7.0.2              | Option no longer used                                 |
| gim-etl                | max-scdr-count           | Option added.    | 7.0.2              |                                                       |
| gim-etl                | std-enterprise-time-zone | Option added.    | 7.0.2              | Option moved from standard-time-zones section.        |
| gim-etl                | purge-action-is-delete   | Option added.    | 7.0.2              |                                                       |
| gim-etl-tenant         |                          | Section added.   | 7.0.2              | New section for tenant default values.                |
| gim-etl-tenant         | days-to-keep-gim-facts   | Option added.    | 7.0.2              | Option moved from days-to-keep-gimfacts section.      |
| gim-etl-tenant         | std-tenant-time-zone     | Option added.    | 7.0.2              | Option moved from standard-time-zones section.        |
| standard-time-zone     |                          | Section removed. | 7.0.2              | Options moved to gim-etl and gim-etl-tenant sections. |
| tenant-fiscal-periods  | tenant                   | Option removed.  | 7.0.2              | Section now used for tenant default values.           |

## Schema Changes in the Info Mart Database 7.6

Table 142 lists the changes to the Info Mart database schema from Genesys Info Mart 7.5 to Genesys Info Mart 7.6. For ease of reference, the tables and views are listed in alphabetical order. For a detailed description of the Info Mart database schema, see the *Genesys Info Mart 7.6 Reference Manual* for your RDBMS (DB2, Microsoft SQL Server, or Oracle).

**Table 142: Schema Changes in Release 7.6**

| Table/View                                                                                                                                                                                                                                                              | Column                                                                      | Change Type    | Changed in Release |
|-------------------------------------------------------------------------------------------------------------------------------------------------------------------------------------------------------------------------------------------------------------------------|-----------------------------------------------------------------------------|----------------|--------------------|
| AG2_INB_V_AGENT_QUEUE_* <sup>a</sup>                                                                                                                                                                                                                                    |                                                                             | Tables added.  | 7.6                |
| AG2_INB_V_AGENT_QUEUE_* <sup>a</sup>                                                                                                                                                                                                                                    | INTERACTION_DESCRIPTOR_KEY                                                  | Column added.  | 7.6.005            |
| AG2_INB_V_AGENT_QUEUE_* <sup>b</sup>                                                                                                                                                                                                                                    |                                                                             | Views added.   | 7.6                |
| AG2_INB_V_AGENT_QUEUE_* <sup>b</sup>                                                                                                                                                                                                                                    | INTERACTION_DESCRIPTOR_KEY                                                  | Column added.  | 7.6.005            |
| AG2_INB_V_I_I_XN_AGENT_* <sup>c</sup>                                                                                                                                                                                                                                   |                                                                             | Tables added.  | 7.6                |
| AG2_INB_V_I_I_XN_AGENT_* <sup>c</sup>                                                                                                                                                                                                                                   | TOTAL_ANSWERED_COUNT                                                        | Column added.  | 7.6.005            |
| AG2_INB_V_I_SESS_STATE_* <sup>c</sup>                                                                                                                                                                                                                                   |                                                                             | Tables added.  | 7.6                |
| AG2_INB_V_I_STATE_RSN_* <sup>c</sup>                                                                                                                                                                                                                                    |                                                                             | Tables added.  | 7.6                |
| AG2_INB_V_I_XN_AGENT_* <sup>a</sup>                                                                                                                                                                                                                                     |                                                                             | Tables added.  | 7.6                |
| AG2_INB_V_I_XN_AGENT_* <sup>a</sup>                                                                                                                                                                                                                                     | TOTAL_SHORT_TALK_COUNT<br>TOTAL_RONA_COUNT<br>TOTAL_ABANDONED_RINGING_COUNT | Columns added. | 7.6.005            |
| AG2_INB_V_I_XN_AGENT_* <sup>b</sup>                                                                                                                                                                                                                                     |                                                                             | Views added.   | 7.6                |
| AG2_INB_V_I_XN_AGENT_* <sup>b</sup>                                                                                                                                                                                                                                     | TOTAL_SHORT_TALK_COUNT<br>TOTAL_RONA_COUNT<br>TOTAL_ABANDONED_RINGING_COUNT | Columns added. | 7.6.005            |
| <p>a. Wildcard (*) represents separate tables for DAY, HOUR, MONTH, respectively.</p> <p>b. Wildcard (*) represents separate views for QRTR, SUBHR, WEEK, YEAR, respectively.</p> <p>c. Wildcard (*) represents separate tables for DAY, HOUR, SUBHR, respectively.</p> |                                                                             |                |                    |

**Table 142: Schema Changes in Release 7.6 (Continued)**

| Table/View                                                                                                                                                                                                                                                              | Column                                                                      | Change Type    | Changed in Release |
|-------------------------------------------------------------------------------------------------------------------------------------------------------------------------------------------------------------------------------------------------------------------------|-----------------------------------------------------------------------------|----------------|--------------------|
| AG2_INB_V_IIXN_AGENT_GRP_* <sup>a</sup>                                                                                                                                                                                                                                 |                                                                             | Tables added.  | 7.6                |
| AG2_INB_V_IIXN_AGENT_GRP_* <sup>a</sup>                                                                                                                                                                                                                                 | TOTAL_SHORT_TALK_COUNT<br>TOTAL_RONA_COUNT<br>TOTAL_ABANDONED_RINGING_COUNT | Columns added. | 7.6.005            |
| AG2_INB_V_IIXN_AGENT_GRP_* <sup>b</sup>                                                                                                                                                                                                                                 |                                                                             | Views added.   | 7.6                |
| AG2_INB_V_IIXN_AGENT_GRP_* <sup>b</sup>                                                                                                                                                                                                                                 | TOTAL_SHORT_TALK_COUNT<br>TOTAL_RONA_COUNT<br>TOTAL_ABANDONED_RINGING_COUNT | Columns added. | 7.6.005            |
| AG2_INB_V_IIXN_ID_* <sup>a</sup>                                                                                                                                                                                                                                        |                                                                             | Tables added.  | 7.6                |
| AG2_INB_V_IIXN_ID_* <sup>a</sup>                                                                                                                                                                                                                                        | TOTAL_ENTERED_OBJ_COUNT                                                     | Column added.  | 7.6.005            |
| AG2_INB_V_IIXN_ID_* <sup>b</sup>                                                                                                                                                                                                                                        |                                                                             | Views added.   | 7.6                |
| AG2_INB_V_IIXN_ID_* <sup>b</sup>                                                                                                                                                                                                                                        | TOTAL_ENTERED_OBJ_COUNT                                                     | Column added.  | 7.6.005            |
| AG2_INB_V_QUEUE_ABN_* <sup>a</sup>                                                                                                                                                                                                                                      |                                                                             | Tables added.  | 7.6                |
| AG2_INB_V_QUEUE_ABN_* <sup>b</sup>                                                                                                                                                                                                                                      |                                                                             | Views added.   | 7.6                |
| AG2_INB_V_QUEUE_ANS_* <sup>a</sup>                                                                                                                                                                                                                                      |                                                                             | Tables added.  | 7.6                |
| AG2_INB_V_QUEUE_ANS_* <sup>b</sup>                                                                                                                                                                                                                                      |                                                                             | Views added.   | 7.6                |
| AG2_INB_V_QUEUE_* <sup>a</sup>                                                                                                                                                                                                                                          |                                                                             | Tables added.  | 7.6                |
| AG2_INB_V_QUEUE_* <sup>b</sup>                                                                                                                                                                                                                                          |                                                                             | Views added.   | 7.6                |
| AG2_INB_V_QUEUE_GRP_* <sup>a</sup>                                                                                                                                                                                                                                      |                                                                             | Tables added.  | 7.6                |
| AG2_INB_V_QUEUE_GRP_* <sup>b</sup>                                                                                                                                                                                                                                      |                                                                             | Views added.   | 7.6                |
| AGGREGATE_CTRL_* <sup>a</sup>                                                                                                                                                                                                                                           | BEGIN_STD_TENANT_DATE_TIME_KEY                                              | Column added.  | 7.6                |
| <p>a. Wildcard (*) represents separate tables for DAY, HOUR, MONTH, respectively.</p> <p>b. Wildcard (*) represents separate views for QRTR, SUBHR, WEEK, YEAR, respectively.</p> <p>c. Wildcard (*) represents separate tables for DAY, HOUR, SUBHR, respectively.</p> |                                                                             |                |                    |

**Table 142: Schema Changes in Release 7.6 (Continued)**

| Table/View                                                                                                                                                                                                                                                              | Column                       | Change Type                                            | Changed in Release |
|-------------------------------------------------------------------------------------------------------------------------------------------------------------------------------------------------------------------------------------------------------------------------|------------------------------|--------------------------------------------------------|--------------------|
| AGGREGATE_CTRL_* <sup>a</sup>                                                                                                                                                                                                                                           | END_STD_TENANT_DATE_TIME_KEY | Column added.                                          | 7.6                |
| AGGREGATE_CTRL_SUBHOUR                                                                                                                                                                                                                                                  |                              | Table added.                                           | 7.6                |
| AIV_INTERACTION_SEGMENT_FACT                                                                                                                                                                                                                                            |                              | View deleted.                                          | 7.6                |
| AIV_RESOURCE_GROUP_FACT                                                                                                                                                                                                                                                 |                              | View deleted.                                          | 7.6                |
| AIV_RESOURCE_STATE_REASON_FACT                                                                                                                                                                                                                                          |                              | View deleted.                                          | 7.6                |
| AIV_VOICE_I_XN_FACT_EXT                                                                                                                                                                                                                                                 |                              | View deleted.                                          | 7.6                |
| AIV_VOICE_SEG_FACT_EXT                                                                                                                                                                                                                                                  |                              | View deleted.                                          | 7.6                |
| AIV_INTERACTION_FACT                                                                                                                                                                                                                                                    |                              | View deleted.                                          | 7.6                |
| CHAT_I_XN_FACT_EXT                                                                                                                                                                                                                                                      |                              | Changed from Table to View for backward compatibility. | 7.6                |
| CHAT_SEG_FACT_EXT                                                                                                                                                                                                                                                       |                              | Changed from Table to View for backward compatibility. | 7.6                |
| DATA_MIGRATION                                                                                                                                                                                                                                                          |                              | Table added.                                           | 7.6                |
| DATE_TIME                                                                                                                                                                                                                                                               |                              | Table added.                                           | 7.6                |
| DT_DND_FACT                                                                                                                                                                                                                                                             |                              | Table added.                                           | 7.6                |
| DT_RES_STATE_FACT                                                                                                                                                                                                                                                       |                              | Table added.                                           | 7.6                |
| DT_RES_STATE_REASON_FACT                                                                                                                                                                                                                                                |                              | Table added.                                           | 7.6                |
| EMAIL_I_XN_FACT_EXT                                                                                                                                                                                                                                                     |                              | Changed from Table to View for backward compatibility. | 7.6                |
| EMAIL_SEG_FACT_EXT                                                                                                                                                                                                                                                      |                              | Changed from Table to View for backward compatibility. | 7.6                |
| <p>a. Wildcard (*) represents separate tables for DAY, HOUR, MONTH, respectively.</p> <p>b. Wildcard (*) represents separate views for QRTR, SUBHR, WEEK, YEAR, respectively.</p> <p>c. Wildcard (*) represents separate tables for DAY, HOUR, SUBHR, respectively.</p> |                              |                                                        |                    |

**Table 142: Schema Changes in Release 7.6 (Continued)**

| Table/View                                                                                                                                                                                                                                                              | Column                   | Change Type                                            | Changed in Release |
|-------------------------------------------------------------------------------------------------------------------------------------------------------------------------------------------------------------------------------------------------------------------------|--------------------------|--------------------------------------------------------|--------------------|
| GVP_CALL_FACT                                                                                                                                                                                                                                                           | MEDIA_SERVER_IXN_ID      | Data type changed from Number(19) to Number(20)        | 7.6                |
| INTERACTION_FACT                                                                                                                                                                                                                                                        | MEDIA_SERVER_IXN_ID      | Data type changed from Number(19) to Number(20)        | 7.6                |
| INTERACTION_FACT                                                                                                                                                                                                                                                        | MEDIA_SERVER_ROOT_IXN_ID | Data type changed from Number(19) to Number(20)        | 7.6                |
| INTERACTION_RESOURCE_FACT                                                                                                                                                                                                                                               |                          | Table added.                                           | 7.6                |
| INTERACTION_RESOURCE_STATE                                                                                                                                                                                                                                              |                          | Table added.                                           | 7.6                |
| INTERACTION_SEGMENT_FACT                                                                                                                                                                                                                                                | MEDIA_SERVER_IXN_ID      | Data type changed from Number(19) to Number(20)        | 7.6                |
| IXN_RESOURCE_STATE_FACT                                                                                                                                                                                                                                                 |                          | Table added.                                           | 7.6                |
| MEDIATION_SEGMENT_FACT                                                                                                                                                                                                                                                  |                          | Table added.                                           | 7.6                |
| MMEDIA_IXN_FACT_EXT                                                                                                                                                                                                                                                     |                          | Table added.                                           | 7.6                |
| MMEDIA_SEG_FACT_EXT                                                                                                                                                                                                                                                     |                          | Table added.                                           | 7.6                |
| R_CHAT_IXN_FACT_EXT                                                                                                                                                                                                                                                     |                          | Changed from Table to View for backward compatibility. | 7.6                |
| R_CHAT_SEG_FACT_EXT                                                                                                                                                                                                                                                     |                          | Changed from Table to View for backward compatibility. | 7.6                |
| R_DT_DND_FACT                                                                                                                                                                                                                                                           |                          | Table added.                                           | 7.6                |
| R_DT_RES_STATE_FACT                                                                                                                                                                                                                                                     |                          | Table added.                                           | 7.6                |
| R_DT_RES_STATE_REASON_FACT                                                                                                                                                                                                                                              |                          | Table added.                                           | 7.6                |
| <p>a. Wildcard (*) represents separate tables for DAY, HOUR, MONTH, respectively.</p> <p>b. Wildcard (*) represents separate views for QRTR, SUBHR, WEEK, YEAR, respectively.</p> <p>c. Wildcard (*) represents separate tables for DAY, HOUR, SUBHR, respectively.</p> |                          |                                                        |                    |

**Table 142: Schema Changes in Release 7.6 (Continued)**

| Table/View                                                                                                                                                                                                                                                              | Column                   | Change Type                                            | Changed in Release |
|-------------------------------------------------------------------------------------------------------------------------------------------------------------------------------------------------------------------------------------------------------------------------|--------------------------|--------------------------------------------------------|--------------------|
| R_EMAIL_IXN_FACT_EXT                                                                                                                                                                                                                                                    |                          | Changed from Table to View for backward compatibility. | 7.6                |
| R_EMAIL_SEG_FACT_EXT                                                                                                                                                                                                                                                    |                          | Changed from Table to View for backward compatibility. | 7.6                |
| R_GVP_CALL_FACT                                                                                                                                                                                                                                                         | MEDIA_SERVER_IXN_ID      | Data type changed from Number(19) to Number(20)        | 7.6                |
| R_INTERACTION_FACT                                                                                                                                                                                                                                                      | MEDIA_SERVER_IXN_ID      | Data type changed from Number(19) to Number(20)        | 7.6                |
| R_INTERACTION_FACT                                                                                                                                                                                                                                                      | MEDIA_SERVER_ROOT_IXN_ID | Data type changed from Number(19) to Number(20)        | 7.6                |
| R_INTERACTION_RESOURCE_FACT                                                                                                                                                                                                                                             |                          | Table added.                                           | 7.6                |
| R_INTERACTION_SEGMENT_FACT                                                                                                                                                                                                                                              | MEDIA_SERVER_IXN_ID      | Data type changed from Number(19) to Number(20)        | 7.6                |
| R_IXN_RESOURCE_STATE_FACT                                                                                                                                                                                                                                               |                          | Table added.                                           | 7.6                |
| R_MEDIATION_SEGMENT_FACT                                                                                                                                                                                                                                                |                          | Table added.                                           | 7.6                |
| R_MMEDIA_IXN_FACT_EXT                                                                                                                                                                                                                                                   |                          | Table added.                                           | 7.6                |
| R_MMEDIA_SEG_FACT_EXT                                                                                                                                                                                                                                                   |                          | Table added.                                           | 7.6                |
| R_SM_RES_SESSION_FACT                                                                                                                                                                                                                                                   |                          | Table added.                                           | 7.6                |
| R_SM_RES_STATE_FACT                                                                                                                                                                                                                                                     |                          | Table added.                                           | 7.6                |
| R_SM_RES_STATE_REASON_FACT                                                                                                                                                                                                                                              |                          | Table added.                                           | 7.6                |
| R_VOICE_RES_FACT_EXT                                                                                                                                                                                                                                                    |                          | Table added.                                           | 7.6                |
| <p>a. Wildcard (*) represents separate tables for DAY, HOUR, MONTH, respectively.</p> <p>b. Wildcard (*) represents separate views for QRTR, SUBHR, WEEK, YEAR, respectively.</p> <p>c. Wildcard (*) represents separate tables for DAY, HOUR, SUBHR, respectively.</p> |                          |                                                        |                    |



**Table 142: Schema Changes in Release 7.6 (Continued)**

| Table/View                                                                                                                                                                                                                                                              | Column                   | Change Type                                            | Changed in Release |
|-------------------------------------------------------------------------------------------------------------------------------------------------------------------------------------------------------------------------------------------------------------------------|--------------------------|--------------------------------------------------------|--------------------|
| R_VQ_SEGMENT_FACT                                                                                                                                                                                                                                                       |                          | Changed from Table to View for backward compatibility. | 7.6                |
| RESOURCE_                                                                                                                                                                                                                                                               | RESOURCE_ALIAS           | Column added.                                          | 7.6                |
| RESOURCE_GROUP_COMBINATION                                                                                                                                                                                                                                              |                          | Table added.                                           | 7.6                |
| SM_RES_SESSION_FACT                                                                                                                                                                                                                                                     |                          | Table added.                                           | 7.6                |
| SM_RES_STATE_FACT                                                                                                                                                                                                                                                       |                          | Table added.                                           | 7.6                |
| SM_RES_STATE_REASON_FACT                                                                                                                                                                                                                                                |                          | Table added.                                           | 7.6                |
| STOP_ACTION                                                                                                                                                                                                                                                             |                          | Table added.                                           | 7.6                |
| TIME_RANGE                                                                                                                                                                                                                                                              | BOUND_5 through BOUND_19 | Columns added.                                         | 7.6                |
| TIME_RANGE                                                                                                                                                                                                                                                              | TIME_RANGE_TYPE          | Column added.                                          | 7.6                |
| TIME_RANGE                                                                                                                                                                                                                                                              | TIME_RANGE_TYPE_CODE     | Column added.                                          | 7.6                |
| VOICE_RES_FACT_EXT                                                                                                                                                                                                                                                      |                          | Table added.                                           | 7.6                |
| VQ_SEGMENT_FACT                                                                                                                                                                                                                                                         |                          | Changed from Table to View for backward compatibility. | 7.6                |
| <p>a. Wildcard (*) represents separate tables for DAY, HOUR, MONTH, respectively.</p> <p>b. Wildcard (*) represents separate views for QRTR, SUBHR, WEEK, YEAR, respectively.</p> <p>c. Wildcard (*) represents separate tables for DAY, HOUR, SUBHR, respectively.</p> |                          |                                                        |                    |

## Schema Changes in the Info Mart Database 7.5

[Table 143](#) lists the changes to the Info Mart database schema from Genesys Info Mart 7.2 to Genesys Info Mart 7.5. For a detailed description of the Info Mart database schema, see the *Genesys Info Mart 7.5 Reference Manual* for your RDBMS (DB2, Microsoft SQL Server, or Oracle).

**Table 143: Schema Changes in Release 7.5**

| Table/View             | Column                      | Change Type   | Changed in Release |
|------------------------|-----------------------------|---------------|--------------------|
| CHAT_I_XN_FACT_EXT     |                             | Table added.  | 7.5                |
| CHAT_SEG_FACT_EXT      |                             | Table added.  | 7.5                |
| EMAIL_I_XN_FACT_EXT    |                             | Table added.  | 7.5                |
| EMAIL_SEG_FACT_EXT     |                             | Table added.  | 7.5                |
| GVP_APPLICATION        |                             | Table added.  | 7.5                |
| GVP_CALL_FACT          |                             | Table added.  | 7.5                |
| GVP_SUBCALL_FACT       |                             | Table added.  | 7.5                |
| GVP_SUBCALL_FLOW       |                             | Table added.  | 7.5                |
| GVP_VOICE_MEDIA_SERVER |                             | Table added.  | 7.5                |
| GVP_WEB_APPL_SERVER    |                             | Table added.  | 7.5                |
| R_CHAT_I_XN_FACT_EXT   |                             | Table added.  | 7.5                |
| R_CHAT_SEG_FACT_EXT    |                             | Table added.  | 7.5                |
| R_EMAIL_I_XN_FACT_EXT  |                             | Table added.  | 7.5                |
| R_EMAIL_SEG_FACT_EXT   |                             | Table added.  | 7.5                |
| R_GVP_CALL_FACT        |                             | Table added.  | 7.5                |
| R_GVP_SUBCALL_FACT     |                             | Table added.  | 7.5                |
| R_VQ_SEGMENT_FACT      |                             | Table added.  | 7.5                |
| USER_DATA_2            |                             | Table added.  | 7.5                |
| VQ_SEGMENT_FACT        |                             | Table added.  | 7.5                |
| INTERACTION_FACT       | USER_DATA_2_KEY             | Column added. | 7.5                |
| INTERACTION_FACT       | MEDIA_SERVER_I_XN_GUID      | Column added. | 7.5                |
| INTERACTION_FACT       | MEDIA_SERVER_ROOT_I_XN_GUID | Column added. | 7.5                |
| INTERACTION_FACT       | NETWORK_SEGMENT_COUNT       | Column added. | 7.5                |
| INTERACTION_FACT       | NETWORK_SEGMENT_DURATION    | Column added. | 7.5                |

**Table 143: Schema Changes in Release 7.5 (Continued)**

| Table/View                 | Column                     | Change Type   | Changed in Release |
|----------------------------|----------------------------|---------------|--------------------|
| INTERACTION_FACT           | USER_DATA_16               | Column added. | 7.5                |
| INTERACTION_FACT           | USER_DATA_17               | Column added. | 7.5                |
| INTERACTION_FACT           | USER_DATA_18               | Column added. | 7.5                |
| INTERACTION_FACT           | USER_DATA_19               | Column added. | 7.5                |
| INTERACTION_FACT           | USER_DATA_20               | Column added. | 7.5                |
| INTERACTION_SEGMENT_FACT   | USER_DATA_2_KEY            | Column added. | 7.5                |
| INTERACTION_SEGMENT_FACT   | MEDIA_SERVER_IXN_ID        | Column added. | 7.5                |
| INTERACTION_SEGMENT_FACT   | MEDIA_SERVER_IXN_GUID      | Column added. | 7.5                |
| INTERACTION_SEGMENT_FACT   | TARGET_ADDRESS             | Column added. | 7.5                |
| INTERACTION_SEGMENT_FACT   | USER_DATA_16               | Column added. | 7.5                |
| INTERACTION_SEGMENT_FACT   | USER_DATA_17               | Column added. | 7.5                |
| INTERACTION_SEGMENT_FACT   | USER_DATA_18               | Column added. | 7.5                |
| INTERACTION_SEGMENT_FACT   | USER_DATA_19               | Column added. | 7.5                |
| INTERACTION_SEGMENT_FACT   | USER_DATA_20               | Column added. | 7.5                |
| R_INTERACTION_FACT         | USER_DATA_2_KEY            | Column added. | 7.5                |
| R_INTERACTION_FACT         | MEDIA_SERVER_IXN_GUID      | Column added. | 7.5                |
| R_INTERACTION_FACT         | MEDIA_SERVER_ROOT_IXN_GUID | Column added. | 7.5                |
| R_INTERACTION_FACT         | NETWORK_SEGMENT_COUNT      | Column added. | 7.5                |
| R_INTERACTION_FACT         | NETWORK_SEGMENT_DURATION   | Column added. | 7.5                |
| R_INTERACTION_FACT         | USER_DATA_16               | Column added. | 7.5                |
| R_INTERACTION_FACT         | USER_DATA_17               | Column added. | 7.5                |
| R_INTERACTION_FACT         | USER_DATA_18               | Column added. | 7.5                |
| R_INTERACTION_FACT         | USER_DATA_19               | Column added. | 7.5                |
| R_INTERACTION_FACT         | USER_DATA_20               | Column added. | 7.5                |
| R_INTERACTION_SEGMENT_FACT | USER_DATA_2_KEY            | Column added. | 7.5                |

**Table 143: Schema Changes in Release 7.5 (Continued)**

| Table/View                 | Column                 | Change Type   | Changed in Release |
|----------------------------|------------------------|---------------|--------------------|
| R_INTERACTION_SEGMENT_FACT | MEDIA_SERVER_IXN_ID    | Column added. | 7.5                |
| R_INTERACTION_SEGMENT_FACT | MEDIA_SERVER_IXN_GUID  | Column added. | 7.5                |
| R_INTERACTION_SEGMENT_FACT | TARGET_ADDRESS         | Column added. | 7.5                |
| R_INTERACTION_SEGMENT_FACT | USER_DATA_16           | Column added. | 7.5                |
| R_INTERACTION_SEGMENT_FACT | USER_DATA_17           | Column added. | 7.5                |
| R_INTERACTION_SEGMENT_FACT | USER_DATA_18           | Column added. | 7.5                |
| R_INTERACTION_SEGMENT_FACT | USER_DATA_19           | Column added. | 7.5                |
| R_INTERACTION_SEGMENT_FACT | USER_DATA_20           | Column added. | 7.5                |
| RESOURCE                   | NETWORK_RESOURCE_FLAG  | Column added. | 7.5                |
| ROUTING_TARGET             | TARGET_OBJECT_SELECTED | Column added. | 7.5                |
| SCHEMA_INFO                | MIGRATE_FLAG           | Column added. | 7.5                |
| STRATEGY                   | STRATEGY_RESULT_CODE   | Column added. | 7.5                |
| STRATEGY                   | STRATEGY_OUTCOME       | Column added. | 7.5                |
| STRATEGY                   | STRATEGY_OUTCOME_CODE  | Column added. | 7.5                |
| TECHNICAL_DESCRIPTOR       | ROLE_REASON            | Column added. | 7.5                |
| TECHNICAL_DESCRIPTOR       | ROLE_REASON_CODE       | Column added. | 7.5                |

---

## Schema Changes in the Info Mart Database 7.2

[Table 144](#) lists the changes to the Info Mart database schema from Genesys Info Mart 7.0.2 to Genesys Info Mart 7.2. The Info Mart database schema is described in detail in the *Genesys Info Mart 7.2 Reference Manual* for your RDBMS (DB2, Microsoft SQL Server or Oracle).

---

**Note:** MEDIA\_RESOURCE\_KEY is a new column in INTERACTION\_FACT, INTERACTION\_SEGMENT\_FACT, and RESOURCE\_SESSION\_FACT. This column represents the Extension or ACD Position associated with the fact. For existing facts in these tables, the migration script populates MEDIA\_RESOURCE\_KEY with a value representing the “Unknown” resource. This is because it is not possible to determine the correct MEDIA\_RESOURCE\_KEY once the data has already been populated in the Info Mart database.

---

**Table 144: Schema Changes in Release 7.2**

| Table/View                          | Column | Change Type  | Changed in Release |
|-------------------------------------|--------|--------------|--------------------|
| <b>Changes Made for Aggregation</b> |        |              |                    |
| AGGREGATE_CTRL_HOUR                 |        | Table added. | 7.2                |
| AGGREGATE_CTRL_DAY                  |        | Table added. | 7.2                |
| AGGREGATE_CTRL_MONTH                |        | Table added. | 7.2                |
| AG_AGENT_VOICE_IXN_HOUR             |        | Table added. | 7.2                |
| AG_AGENT_VOICE_IXN_DAY              |        | Table added. | 7.2                |
| AG_AGENT_VOICE_IXN_WEEK             |        | View added.  | 7.2                |
| AG_AGENT_VOICE_IXN_MONTH            |        | Table added. | 7.2                |
| AG_AGENT_VOICE_IXN_QUARTER          |        | View added.  | 7.2                |
| AG_AGENT_VOICE_IXN_YEAR             |        | View added.  | 7.2                |
| AG_SKILL_GROUP_ABN_HOUR             |        | Table added. | 7.2                |
| AG_SKILL_GROUP_ABN_DAY              |        | Table added. | 7.2                |
| AG_SKILL_GROUP_ABN_WEEK             |        | View added.  | 7.2                |
| AG_SKILL_GROUP_ABN_MONTH            |        | Table added. | 7.2                |
| AG_SKILL_GROUP_ABN_QUARTER          |        | View added.  | 7.2                |
| AG_SKILL_GROUP_ABN_YEAR             |        | View added.  | 7.2                |
| AG_SKILL_GROUP_HOUR                 |        | Table added. | 7.2                |
| AG_SKILL_GROUP_DAY                  |        | Table added. | 7.2                |
| AG_SKILL_GROUP_WEEK                 |        | View added.  | 7.2                |

**Table 144: Schema Changes in Release 7.2 (Continued)**

| Table/View                     | Column | Change Type  | Changed in Release |
|--------------------------------|--------|--------------|--------------------|
| AG_SKILL_GROUP_MONTH           |        | Table added. | 7.2                |
| AG_SKILL_GROUP_QUARTER         |        | View added.  | 7.2                |
| AG_SKILL_GROUP_YEAR            |        | View added.  | 7.2                |
| AG_SKILL_RESOURCE_ABN_HOUR     |        | Table added. | 7.2                |
| AG_SKILL_RESOURCE_ABN_DAY      |        | Table added. | 7.2                |
| AG_SKILL_RESOURCE_ABN_WEEK     |        | View added.  | 7.2                |
| AG_SKILL_RESOURCE_ABN_MONTH    |        | Table added. | 7.2                |
| AG_SKILL_RESOURCE_ABN_QUARTER  |        | View added.  | 7.2                |
| AG_SKILL_RESOURCE_ABN_YEAR     |        | View added.  | 7.2                |
| AG_SKILL_RESOURCE_HOUR         |        | Table added. | 7.2                |
| AG_SKILL_RESOURCE_DAY          |        | Table added. | 7.2                |
| AG_SKILL_RESOURCE_WEEK         |        | View added.  | 7.2                |
| AG_SKILL_RESOURCE_MONTH        |        | Table added. | 7.2                |
| AG_SKILL_RESOURCE_QUARTER      |        | View added.  | 7.2                |
| AG_SKILL_RESOURCE_YEAR         |        | View added.  | 7.2                |
| AG_SKILL_VOICE_INB_IXN_HOUR    |        | Table added. | 7.2                |
| AG_SKILL_VOICE_INB_IXN_DAY     |        | Table added. | 7.2                |
| AG_SKILL_VOICE_INB_IXN_WEEK    |        | View added.  | 7.2                |
| AG_SKILL_VOICE_INB_IXN_MONTH   |        | Table added. | 7.2                |
| AG_SKILL_VOICE_INB_IXN_QUARTER |        | View added.  | 7.2                |
| AG_SKILL_VOICE_INB_IXN_YEAR    |        | View added.  | 7.2                |
| AG_STATE_REASON_VOICE_HOUR     |        | Table added. | 7.2                |
| AG_STATE_REASON_VOICE_DAY      |        | Table added. | 7.2                |
| AG_STATE_REASON_VOICE_WEEK     |        | View added.  | 7.2                |
| AG_STATE_REASON_VOICE_MONTH    |        | Table added. | 7.2                |

**Table 144: Schema Changes in Release 7.2 (Continued)**

| Table/View                                        | Column                 | Change Type   | Changed in Release |
|---------------------------------------------------|------------------------|---------------|--------------------|
| AG_STATE_REASON_VOICE_QUARTER                     |                        | View added.   | 7.2                |
| AG_STATE_REASON_VOICE_YEAR                        |                        | View added.   | 7.2                |
| AIV_INTERACTION_FACT                              |                        | View added.   | 7.2                |
| AIV_INTERACTION_SEGMENT_FACT                      |                        | View added.   | 7.2                |
| AIV_RESOURCE_GROUP_FACT                           |                        | View added.   | 7.2                |
| AIV_RESOURCE_STATE_REASON_FACT                    |                        | View added.   | 7.2                |
| AIV_VOICE_IYN_FACT_EXT                            |                        | View added.   | 7.2                |
| AIV_VOICE_SEG_FACT_EXT                            |                        | View added.   | 7.2                |
| TIME_RANGE                                        |                        | Table added.  | 7.2                |
| ENTERPRISE_DATE                                   | CAL_YEAR_WEEK_NUM      | Column added. | 7.2                |
| ENTERPRISE_DATE                                   | CAL_YEAR_MONTH_DAY_NUM | Column added. | 7.2                |
| ENTERPRISE_DATE                                   | CAL_YEAR_MONTH_NUM     | Column added. | 7.2                |
| ENTERPRISE_DATE                                   | SECONDS_SINCE_EPOCH    | Column added. | 7.2                |
| ENTERPRISE_MONTH                                  | CAL_YEAR_MONTH_NUM     | Column added. | 7.2                |
| ENTERPRISE_MONTH                                  | CAL_YEAR               | Column added. | 7.2                |
| <b>Changes Made for Outbound Contact Solution</b> |                        |               |                    |
| CALLING_LIST                                      |                        | Table added.  | 7.2                |
| CALLING_LIST_METRIC_FACT                          |                        | Table added.  | 7.2                |
| CALLING_LIST_TO_CAMP_FACT                         |                        | Table added.  | 7.2                |
| CALL_RESULT                                       |                        | Table added.  | 7.2                |
| CAMPAIGN                                          |                        | Table added.  | 7.2                |
| CAMPAIGN_GROUP_SESSION_FACT                       |                        | Table added.  | 7.2                |
| CAMPAIGN_GROUP_STATE                              |                        | Table added.  | 7.2                |
| CAMPAIGN_GROUP_STATE_FACT                         |                        | Table added.  | 7.2                |

**Table 144: Schema Changes in Release 7.2 (Continued)**

| Table/View                                     | Column | Change Type  | Changed in Release |
|------------------------------------------------|--------|--------------|--------------------|
| CONTACT_ATTEMPT_FACT                           |        | Table added. | 7.2                |
| CONTACT_INFO_TYPE                              |        | Table added. | 7.2                |
| DIALING_MODE                                   |        | Table added. | 7.2                |
| GROUP_TO_CAMPAIN_FACT                          |        | Table added. | 7.2                |
| RECORD_FIELD_GROUP_1                           |        | Table added. | 7.2                |
| RECORD_FIELD_GROUP_2                           |        | Table added. | 7.2                |
| RECORD_STATUS                                  |        | Table added. | 7.2                |
| RECORD_TYPE                                    |        | Table added. | 7.2                |
| TIME_ZONE                                      |        | Table added. | 7.2                |
| <b>Changes made for Resource State Reasons</b> |        |              |                    |
| RESOURCE_STATE_REASON                          |        | Table added. | 7.2                |
| RESOURCE_STATE_REASON_FACT                     |        | Table added. | 7.2                |
| <b>Changes made for Intraday Loading</b>       |        |              |                    |
| R_INTERACTION_FACT                             |        | Table added. | 7.2                |
| R_INTERACTION_SEGMENT_FACT                     |        | Table added. | 7.2                |
| R_VOICE_IXN_FACT_EXT                           |        | Table added. | 7.2                |
| R_VOICE_SEG_FACT_EXT                           |        | Table added. | 7.2                |
| R_PLACE_GROUP_FACT                             |        | Table added. | 7.2                |
| R_RESOURCE_GROUP_FACT                          |        | Table added. | 7.2                |
| R_RESOURCE_SKILL_FACT                          |        | Table added. | 7.2                |
| R_RESOURCE_SESSION_FACT                        |        | Table added. | 7.2                |
| R_RESOURCE_STATE_FACT                          |        | Table added. | 7.2                |
| R_RESOURCE_STATE_REASON_FACT                   |        | Table added. | 7.2                |
| R_CALLING_LIST_METRIC_FACT                     |        | Table added. | 7.2                |



**Table 144: Schema Changes in Release 7.2 (Continued)**

| Table/View                    | Column                         | Change Type   | Changed in Release |
|-------------------------------|--------------------------------|---------------|--------------------|
| R_CALLING_LIST_TO_CAMP_FACT   |                                | Table added.  | 7.2                |
| R_CAMPAIGN_GROUP_SESSION_FACT |                                | Table added.  | 7.2                |
| R_CAMPAIGN_GROUP_STATE_FACT   |                                | Table added.  | 7.2                |
| R_CONTACT_ATTEMPT_FACT        |                                | Table added.  | 7.2                |
| R_GROUP_TO_CAMPAIGN_FACT      |                                | Table added.  | 7.2                |
| R_AG_AGENT_VOICE_IXN_HOUR     |                                | Table added.  | 7.2                |
| R_AG_SKILL_GROUP_ABN_HOUR     |                                | Table added.  | 7.2                |
| R_AG_SKILL_GROUP_HOUR         |                                | Table added.  | 7.2                |
| R_AG_SKILL_RESOURCE_ABN_HOUR  |                                | Table added.  | 7.2                |
| R_AG_SKILL_RESOURCE_HOUR      |                                | Table added.  | 7.2                |
| R_AG_SKILL_VOICE_INB_IXN_HOUR |                                | Table added.  | 7.2                |
| R_AG_STATE_REASON_VOICE_HOUR  |                                | Table added.  | 7.2                |
| <b>Other enhancements</b>     |                                |               |                    |
| GROUP_                        | GROUP_TYPE_CODE                | Column added. | 7.2                |
| GROUP_                        | GROUP_CFG_TYPE_ID              | Column added. | 7.2                |
| INTERACTION_FACT              | MEDIA_RESOURCE_KEY             | Column added. | 7.2                |
| INTERACTION_FACT              | AGENT_HANDLE_DURATION          | Column added. | 7.2                |
| INTERACTION_FACT              | MET_SERVICE_OBJECTIVE_FLAG     | Column added. | 7.2                |
| INTERACTION_FACT              | ANSWERED_WITH_SKILL_MATCH_FLAG | Column added. | 7.2                |
| INTERACTION_SEGMENT_FACT      | MEDIA_RESOURCE_KEY             | Column added. | 7.2                |
| INTERACTION_TYPE              | INTERACTION_TYPE_CODE          | Column added. | 7.2                |
| INTERACTION_TYPE              | INTERACTION_SUBTYPE            | Column added. | 7.2                |

**Table 144: Schema Changes in Release 7.2 (Continued)**

| Table/View                  | Column                      | Change Type   | Changed in Release |
|-----------------------------|-----------------------------|---------------|--------------------|
| INTERACTION_TYPE            | INTERACTION_SUBTYPE_CODE    | Column added. | 7.2                |
| MEDIA_TYPE                  | MEDIA_NAME_CODE             | Column added. | 7.2                |
| REQUESTED_SKILL             | TENANT_KEY                  | Column added. | 7.2                |
| REQUESTED_SKILL_COMBINATION |                             | Table added.  | 7.2                |
| RESOURCE_                   | RESOURCE_TYPE_CODE          | Column added. | 7.2                |
| RESOURCE_                   | RESOURCE_CFG_TYPE_ID        | Column added. | 7.2                |
| RESOURCE_SESSION_FACT       | MEDIA_RESOURCE_KEY          | Column added. | 7.2                |
| RESOURCE_STATE_FACT         | STATE_TYPE_CODE             | Column added. | 7.2                |
| RESOURCE_STATE_FACT         | STATE_NAME_CODE             | Column added. | 7.2                |
| ROUTING_TARGET              | ROUTING_TARGET_TYPE         | Column added. | 7.2                |
| ROUTING_TARGET              | ROUTING_TARGET_TYPE_CODE    | Column added. | 7.2                |
| SCHEMA_INFO                 | INSTALL_TIME                | Column added. | 7.2                |
| SCHEMA_INFO                 | MIGRATE_TIME                | Column added. | 7.2                |
| STRATEGY                    | STRATEGY_TYPE_CODE          | Column added. | 7.2                |
| TECHNICAL_DESCRIPTOR        | TECHNICAL_RESULT_CODE       | Column added. | 7.2                |
| TECHNICAL_DESCRIPTOR        | RESULT_REASON_CODE          | Column added. | 7.2                |
| TECHNICAL_DESCRIPTOR        | RESOURCE_ROLE_CODE          | Column added. | 7.2                |
| TENANT_DATE                 | CAL_YEAR_WEEK_NUM           | Column added. | 7.2                |
| TENANT_DATE                 | CAL_YEAR_MONTH_DAY_NUM      | Column added. | 7.2                |
| TENANT_DATE                 | CAL_YEAR_MONTH_NUM          | Column added. | 7.2                |
| TIME_OF_DAY                 | TIME_INTERVAL_15_MINUTE_NUM | Column added. | 7.2                |

**Table 144: Schema Changes in Release 7.2 (Continued)**

| Table/View          | Column                      | Change Type   | Changed in Release |
|---------------------|-----------------------------|---------------|--------------------|
| TIME_OF_DAY         | TIME_INTERVAL_30_MINUTE_NUM | Column added. | 7.2                |
| TIME_OF_DAY         | TIME_INTERVAL_60_MINUTE_NUM | Column added. | 7.2                |
| VOICE_I_XN_FACT_EXT | AGENT_TALK_DURATION         | Column added. | 7.2                |
| VOICE_I_XN_FACT_EXT | AGENT_HOLD_DURATION         | Column added. | 7.2                |
| VOICE_I_XN_FACT_EXT | ANSWERED_BY_AGENT_FLAG      | Column added. | 7.2                |
| VOICE_I_XN_FACT_EXT | TRANSFERRED_BY_AGENT_FLAG   | Column added. | 7.2                |
| VOICE_I_XN_FACT_EXT | ABANDONED_BY_CUSTOMER_FLAG  | Column added. | 7.2                |
| AUDIT               | ARTIFICIALLY_ENDED          | Column added. | 7.2                |

## Schema Changes in the Info Mart Database 7.0.2

[Table 145](#) lists the Info Mart database schema changes for Genesys Info Mart 7.0.2. The Info Mart database schema is described in detail in the *Genesys Info Mart 7.0.2 Reference* for your RDBMS (DB2, Microsoft SQL Server or Oracle).

**Table 145: Schema Changes in Release 7.0.2**

| Table/View | Column               | Change Type   | Changed in Release |
|------------|----------------------|---------------|--------------------|
| AUDIT      |                      | Table added.  | 7.0.2              |
| All tables | CREATE_AUDIT_KEY     | Column added. | 7.0.2              |
| All tables | UPDATE_AUDIT_KEY     | Column added. | 7.0.2              |
| All tables | GMT_ROW_CREATED_TIME | Column added. | 7.0.2              |
| All tables | GMT_ROW_UPDATED_TIME | Column added. | 7.0.2              |

**Table 145: Schema Changes in Release 7.0.2 (Continued)**

| Table/View               | Column                  | Change Type   | Changed in Release |
|--------------------------|-------------------------|---------------|--------------------|
| All tables               | PURGE_FLAG              | Column added. | 7.0.2              |
| INTERACTION_FACT         | ACTIVE_FLAG             | Column added. | 7.0.2              |
| INTERACTION_SEGMENT_FACT | ACTIVE_FLAG             | Column added. | 7.0.2              |
| RESOURCE_SESSION_FACT    | ACTIVE_FLAG             | Column added. | 7.0.2              |
| RESOURCE_STATE_FACT      | ACTIVE_FLAG             | Column added. | 7.0.2              |
| VOICE_IXN_FACT_EXT       | STD_ENTERPRISE_DATE_KEY | Column added. | 7.0.2              |
| VOICE_IXN_FACT_EXT       | STD_TENANT_DATE_KEY     | Column added. | 7.0.2              |
| VOICE_IXN_FACT_EXT       | ACTIVE_FLAG             | Column added. | 7.0.2              |
| VOICE_SEG_FACT_EXT       | STD_ENTERPRISE_DATE_KEY | Column added. | 7.0.2              |
| VOICE_SEG_FACT_EXT       | STD_TENANT_DATE_KEY     | Column added. | 7.0.2              |
| VOICE_SEG_FACT_EXT       | ACTIVE_FLAG             | Column added. | 7.0.2              |



## Chapter

# 48

## Genesys Info Mart Migration Procedures

This chapter provides a high-level description of the migration procedures for Genesys Info Mart and for other products that support and enable it. Refer to the other sections of this book for detailed information to help you migrate Framework and other Genesys solutions, such as Call Concentrator.

This chapter contains the following sections:

- [Migrating Genesys Info Mart from 7.5.x to 7.6.x, page 810](#)
- [Migrating Genesys Info Mart from 7.2.x to 7.6.x, page 828](#)
- [Migrating Genesys Info Mart from 7.0.2 to 7.6.x, page 829](#)
- [Migrating Genesys Info Mart from 7.2.x to 7.5.x, page 829](#)
- [Migrating Genesys Info Mart from 7.0.2 to 7.5.x, page 837](#)
- [Migrating Genesys Info Mart from 7.0.2 to 7.2.x, page 837](#)
- [Migrating Genesys Info Mart from 7.0.1 to 7.0.2, page 851](#)

---

**Note:** The information in this chapter covers migration information for Genesys Info Mart up to general release 7.6.006. If you are migrating your Genesys Info Mart from release 7.5, 7.2, or 7.0 to a general release later than 7.6.006.x, contact Genesys Technical Support for available migration instructions. If you are upgrading your Genesys Info Mart from a 7.6 release to a later 7.6 release, consult the Deployment Procedure supplied with the release to which you are upgrading.

---

---

# Migrating Genesys Info Mart from 7.5.x to 7.6.x

This section describes the steps that are required to migrate Genesys Info Mart and supporting software from release 7.5.x to release 7.6.x.

## Migration Roadmap

The migration procedure from release 7.5.x to 7.6.x is provided for:

- An environment with Genesys Info Mart 7.5.005 or later.
- An environment with Genesys Info Mart 7.5.004 or later.

You can migrate to the currently shipping version of Genesys Info Mart 7.6.x.

---

**Note:** If you have a 7.5 release earlier than 7.5.004.07, upgrade to release 7.5.004.07 using the *Deployment Procedure* supplied with it, and then use the migration instructions in this document to migrate from release 7.5.004.07 to 7.6.

---

The migration process preserves the Genesys Info Mart functionality available to you in release 7.5.x within your current data source environment:

- Genesys does not recommend migrating any of the data sources at the time of Genesys Info Mart migration. If you need to migrate any of the data sources to a more recent release, do so after you complete the Genesys Info Mart migration successfully. Refer to *Genesys Info Mart 7.6 Operations Guide* for guidelines.
- If you need to enable new features introduced in release 7.6, do so after you complete the Genesys Info Mart migration successfully. Refer to the *Genesys Info Mart 7.6 Deployment Guide* for information on how to enable new features.

---

**Note:** If you choose to enable some of the new functionality that requires Interaction Concentrator 7.6, do not create a new `ICON Application` object in the Configuration Layer when upgrading Interaction Concentrator. Instead, use the existing `Application` in the Configuration Layer when you install the Interaction Concentrator upgrade. Refer to the *Genesys Info Mart 7.6 Operations Guide* for details.

---

## Migration Planning

1. Make sure to review all of the instructions carefully before you execute any of them.

2. Review the *Genesys Info Mart 7.6 Release Advisory* for information about known operating system and RDBMS issues, and potential ways to work around these issues.
3. Review the data-size estimates for the Staging Area database in the *Genesys Info Mart 7.6 Database Size Estimator*. The 7.6 release stores more data than the 7.5 release; therefore, if necessary, allocate more physical database storage.
4. Review the data-size estimates for the Info Mart 7.6 database in the *Genesys Info Mart 7.6 Database Size Estimator*. The 7.6 release stores more data than the 7.5 release; therefore, if necessary, allocate more physical database storage.
5. Plan to execute your migration at a time when there is relatively little contact center activity and relatively little demand for access to Info Mart database data for reporting purposes, such as during a regularly scheduled maintenance window. Several of the steps can take a significant amount of time to complete, which might affect the availability of Info Mart data.

Carefully following the migration procedure in this document helps you to:

- Minimize the time where Genesys Info Mart is not extracting, transforming, and loading new data.
  - Minimize the time where the Info Mart database is not available for reporting.
6. Review the information about the new job, `Job_MigrateGIM`, in the *Genesys Info Mart 7.6 Operations Guide*. It is important that you understand the role of this job in the migration process and its effect on other daily jobs. Remember that, during its first run, `Job_MigrateGIM` will migrate the data from the critical tables only. Plan on scheduling `Job_MigrateGIM` to run on a daily basis to migrate the data from non-critical tables until all data is migrated. This should minimize the impact of the migration process on your operations.
  7. If you are currently storing ICON Voice details and ICON Multimedia details in the same IDB, you must now store them in separate IDBs. The “[Pre-Migration Procedure](#)” section below includes a procedure to separate the storage of ICON Multimedia details.
  8. If you are migrating from release 7.5.005.05 or a later 7.5 release, review the changes to technical descriptor keys described in “[Technical Descriptor Key Changes](#)” on [page 769](#). Analyze if you require any adjustments to your custom fact, summary, or aggregate tables that depend on those keys. Plan to make any necessary adjustments after completing critical data migration.

## Pre-Migration Procedure

|                                  |                                                                                                                                               |
|----------------------------------|-----------------------------------------------------------------------------------------------------------------------------------------------|
| <b>Preserving Custom Changes</b> | Identify any custom changes that you made to the Genesys Info Mart 7.5 Merge Staging Area, Staging Area, and Info Mart databases—for example, |
|----------------------------------|-----------------------------------------------------------------------------------------------------------------------------------------------|

table spaces, partitions, additional indexes, views, or permissions. This includes the permissions or privileges that you granted to the users of the Staging Area and Info Mart databases, as described in the section about database privileges in the *Genesys Info Mart 7.5 Deployment Guide*.

The Genesys Info Mart SQL scripts that you will run to update these databases sometimes create new tables, instead of updating the old tables. They also replace some tables with views, for backward compatibility. You will need to re-create any custom database objects or permissions that become lost or invalidated during the update process.

Check if you customized any of the application startup arguments for your Genesys Info Mart 7.5 application. The 7.6 installation process will overwrite these arguments and you will lose any changes you made. You will need to customize the startup arguments once again for the 7.6 application in one of the following locations, depending on your startup process for Genesys Info Mart Server:

- If you are running Genesys Info Mart Server as a Windows service, the Path to executable: text box of the Windows Service Properties dialog box includes the startup arguments. They could also be copied to the `gim_etl_update_service_arguments.bat` file located in your `gim-etl` home folder.
- If you are using Genesys Solution Control Interface to start and stop Genesys Info Mart Server, the Start Info tab of the Genesys Info Mart Application object in Configuration Manager includes the command-line arguments.
- If you are using the `gim_etl_server.bat` file to start Genesys Info Mart Server, the .bat file includes the command-line arguments. (The `gim_etl_server.bat` file is located in your `gim-etl` home folder.)

### Storing Voice and Multimedia Details in Separate IDBs

With Genesys Info Mart release 7.6, the ICON application that you use to store Multimedia data *must* use a different IDB than any ICON application that is storing Voice details. If you are currently storing Voice details and Multimedia details in the same IDB, you must now begin storing them in separate IDBs.

---

**Note:** Loss of Multimedia interaction data may occur in Genesys Info Mart when changing the IDB used to store ICON Multimedia details. Genesys Info Mart may have incomplete information for interactions that were active at the time Multimedia data was being populated to the old (joint) IDB, and completed at the time Multimedia data was being populated to the new IDB.

---



Use the following procedure to separate the storage of Voice details and Multimedia details into different IDBs:

---

**Note:** All references to the ICON application in the procedure imply the ICON application that you have dedicated to handling the Multimedia data.

---

1. Create and initialize a new IDB (hereafter referred to as *Multimedia IDB*) to contain ICON Multimedia details (separate from ICON Voice details).

Refer to the *Interaction Concentrator 7.5 Deployment Guide* for instructions on how to create and initialize an IDB.

Also, use the instructions in the “Preparing IDB” section of the *Genesys Info Mart 7.5 Deployment Guide* to:

- Run the SQL scripts that are provided with Genesys Info Mart 7.5 for the new IDB (`make_icon_indexes_for_gim.sql` and `make_iconmm_indexes_for_gim.sql`).
- Ensure that database access is configured correctly so that Genesys Info Mart 7.5 can access the IDB data.

2. Configure a Database Access Point (DAP) for the ICON application to access this new IDB:

- Use distinctive naming convention for the DAP configuration object.
- Make sure the `role` option includes `gcc`, `gud`, `gls` values for this DAP.
- Do not add this DAP to the ICON’s `Connections` tab at this time.

Refer to the *Interaction Concentrator 7.5 Deployment Guide* for the procedure for configuring a DAP for an IDB.

3. Configure a DAP for Genesys Info Mart to use to access the Multimedia IDB:

- Use distinctive naming convention for the DAP object.
- Specify the `role` option with the `ICON_MM` value for this DAP.

Refer to the *Genesys Info Mart 7.5 Deployment Guide* for the procedure for configuring a DAP with the role `ICON_MM`.

4. Add the DAP object you have created in [Step 3](#) to the `Connections` tab of the Genesys Info Mart `Application` object.
5. Stop your ICON application.

Refer to the *Interaction Concentrator 7.5 Deployment Guide* for the procedure for stopping Interaction Concentrator.

6. Add the new ICON DAP object you have created in [Step 2](#) to the `Connections` tab of the ICON `Application` object.
7. Remove the old ICON DAP object (used to access the IDB where Voice details and Multimedia details were joint) from the `Connections` tab of the ICON `Application` object.
8. Start your ICON application.

Refer to the *Interaction Concentrator 7.5 Deployment Guide* for the procedure for starting Interaction Concentrator.

The ICON application should now store Multimedia details to the new IDB, and this new IDB should not contain any Voice details.

As a result, Genesys Info Mart is now able to extract the data from the new Multimedia IDB as well as the remaining Multimedia data from the old IDB (where Voice details and Multimedia details were joint).

To complete the separation of Multimedia details storage from Voice details storage, perform the following steps, either before or after migrating Genesys Info Mart to release 7.6:

1. Monitor the Genesys Info Mart data extraction until all of the Multimedia data is extracted from the old (joint) IDB.

You can use the `ADMIN_EXTRACT_HISTORY` view (described in *Genesys Info Mart 7.5 Operations Guide*) to tell when all of the Multimedia data from the old (joint) IDB has been processed by Genesys Info Mart. Look at the rows where `DBCNECTION` indicates the old (joint) IDB; once the `LATEST_DATA_TIME` column reaches the time of the last Multimedia data that was written to the old IDB, all of the Multimedia data from the old IDB should have been processed.

2. After Genesys Info Mart has extracted all of the Multimedia data from the old (joint) IDB, remove the `ICON_MM` role from the `DAP` object that provides access to the old (joint) IDB. (You may want to wait an additional week before removing the `ICON_MM` role from the old `DAP`.)

This way, Genesys Info Mart detects that only Voice details should now be extracted from that IDB.

## Migration Procedure

1. Stop the Genesys Info Mart 7.5 Scheduler by setting the `run-scheduler` configuration option to `FALSE` in the `schedule` section of the `Genesys Info Mart Application` object. This will prevent the Genesys Info Mart 7.5 Server from running 7.5 ETL jobs automatically.
2. Use the Genesys Info Mart Administration Console 7.5 to run a final ETL cycle manually with the 7.5 jobs, including:
  - a. The data extraction jobs that you normally schedule (`Job_ExtractICON`, `Job_ExtractSS`, and `Job_ExtractGVP`, as applicable).
  - b. `Job_TransformGIM`.
  - c. `Job_LoadRecent`.
3. Use the Genesys Info Mart Administration Console 7.5 to run the 7.5 daily jobs that you normally schedule:
  - a. `Job_LoadGIM`—This step moves all data from the intraday fact tables (with the exception of active e-mail interactions) to the historical fact tables.

- b. Job\_AggregateGIM.
  - c. Job\_MaintainGIM.
4. Use Solution Control Interface (SCI) to stop the Genesys Info Mart 7.5 Server process.

---

**Note:** From this point onward, the ETL engine will process no new data until all critical migration is complete and until it is safe to resume ETL execution by using the 7.6 ETL jobs.

---

5. If you perform multi-IDB merge in your deployment, back up your 7.5 Merge Staging Area database.
6. Back up your 7.5 Staging Area database.
7. Back up your 7.5 Info Mart database.
8. Back up the files that you customized from your Genesys Info Mart 7.5 installation package. The installation process will overwrite these files and you will lose any changes that you made.
9. Make a note of the application startup arguments if you customized them for your Genesys Info Mart 7.5 application. The installation process will overwrite these arguments and you will lose any changes you made.
  - If you are running Genesys Info Mart Server as a Windows service, you should have modified the startup arguments in the `gim_etl_update_service_arguments.bat` file when you deployed your Genesys Info Mart Server 7.5. If you modified the `gim_etl_update_service_arguments.bat` file with release 7.5, back up a copy of your `.bat` file that is located in your `gim-etl` home folder.
  - If you are not running Genesys Info Mart Server as a Windows service, but rather use Genesys Solution Control Interface to start and stop Genesys Info Mart Server, note the command-line arguments on the `Start Info` tab of the Genesys Info Mart Application object in Configuration Manager.
  - If you are using the `gim_etl_server.bat` file to start Genesys Info Mart Server, back up a copy of your `gim_etl_server.bat` file that is located in your `gim-etl` home folder.
10. Install the Genesys Info Mart 7.6 installation package on your Genesys Info Mart Server host over your current Genesys Info Mart 7.5 installation. See the chapter about installing Genesys Info Mart components in the *Genesys Info Mart 7.6 Deployment Guide*.
11. Update the 7.6 application startup arguments if you previously customized them for your Genesys Info Mart 7.5 application.
  - If you are running Genesys Info Mart Server as a Windows service, open the `General` tab of the Genesys Info Mart 7.6 Windows service Properties window. Copy the arguments for the 7.6 application from the `Path to executable:` text box to the `gim_etl_update_service_`

arguments.bat file located in your 7.6 gim-etl home folder. Update the arguments per the 7.5 backup copy of the .bat file that you created in [Step 9](#), but preserve the path to the 7.6 executable. Once you update the 7.6 .bat file, execute it in order for the changes to take affect.

Genesys recommends that you make the same changes to the Genesys Info Mart Application object in the Configuration Manager.

- If you are using Genesys Solution Control Interface to start and stop Genesys Info Mart Server, modify the command-line arguments on the Start Info tab of the Genesys Info Mart Application object in Configuration Manager, as noted in [Step 9](#). Preserve the path to the 7.6 executable.
  - If you are using the gim\_etl\_server.bat file to start Genesys Info Mart Server, use the content of the backup 7.5 gim\_etl\_server.bat file to update the command-line arguments in the 7.6 copy of the gim\_etl\_server.bat file that the installation placed into your gim-etl home folder. Preserve the path to the 7.6 executable.
12. Install the Genesys Info Mart 7.6 Administration Console installation package on your Configuration Manager host over your current, Genesys Info Mart Administration Console 7.5 installation.
  13. Run the SQL script that is provided with Genesys Info Mart release 7.6 to migrate the Staging Area database schema.

---

**Notes:** Make sure that you back up your 7.5 Staging Area database before you run the migration script. This step can take a long time depending on the amount of data in the database.

Also, make sure that you turn on database session logging, so that if the script fails before it is finished, it will be easy for you to determine which statements have been completed successfully; then, you can eliminate these from the script before you restart it.

If you cannot determine which statements completed successfully, restore the 7.5 Staging Area database from the backup you just created and repeat [Steps 13a](#) through [13e](#).

---

Use your RDBMS management tool to:

- a. Navigate to the genesys\_info\_mart\db\_scripts subdirectory of the Genesys Info Mart 7.6 product CD.
- b. Navigate to the unix or windows subdirectory that corresponds to the operating system on which you will be running the database scripts.
- c. Navigate to the sql\_scripts subdirectory.
- d. Navigate to the RDBMS-specific directory that corresponds to your Staging Area database type (db2, mssql, or oracle).

- e. Run the `migrate_gim_staging_area.sql` script.  
Ignore error messages indicating that objects cannot be created or renamed because they already exist or do not yet exist. The following are specific examples of objects that might cause these error messages:
  - `STG_EXTRACT_THROTTLE.UNFINISHED` column
  - `STG_ICON_CALL_INFO.ICI_CAF_KEY_IDX` index
  - `STG_ICON_CALL_INFO.ICI_CALLID_IDX` index
  - `STG_PARTY_SEGMENT_INFO.STG_PSI_INT_SEG_IDX` index

---

**Note:** The SQL scripts do not qualify database objects according to their schema or owner. When you run the SQL scripts, make sure that you use the ID of the schema or owner to log in to the database. You noted this information in the appropriate section of the installation checklist in the *Genesys Info Mart 7.6 Deployment Guide*.

---

14. Run the SQL script that is provided with Genesys Info Mart release 7.6 to load the Staging Area database with metadata used by the jobs that perform aggregation (`JOB_LoadRecent` and `JOB_AggregateGIM`).

Use your RDBMS management tool to:

- a. Navigate to the `genesys_info_mart\db_scripts` subdirectory of the Genesys Info Mart 7.6 product CD.
  - b. Navigate to the `unix` or `windows` subdirectory that corresponds to the operating system on which you will be running the database scripts.
  - c. Navigate to the `sql_scripts` subdirectory.
  - d. Navigate to the RDBMS-specific directory that corresponds to your Staging Area database type (`db2`, `mssql`, or `oracle`).
  - e. Run the `load_gim_staging_area.sql` script.
15. Run the SQL script that is provided with Genesys Info Mart release 7.6 to migrate the Info Mart database schema.

---

**Warning!** From this point onward, the Info Mart database should not be accessed by report queries or other scheduled activities, such as custom aggregation, until all critical migration is complete. Doing otherwise would interfere with the migration process which will be modifying database tables, views, and indexes, and performing critical data migration.

---

---

**Notes:** Make sure that you back up your 7.5 Info Mart database before you run the migration script. This step can take a long time, depending on the amount of data in the database.

Also make sure that you turn on database session logging, so that if the script fails before it is finished, it will be easy for you to determine which statements have completed successfully; then, you can eliminate these from the script before you restart it.

If you cannot determine which statements completed successfully, restore the 7.5 Info Mart database from the backup you just created and repeat [Steps 15a](#) through [15e](#).

---

Use your RDBMS management tool to:

- a. Navigate to the `genesys_info_mart\db_scripts` subdirectory of the Genesys Info Mart 7.6 product CD.
  - b. Navigate to the `unix` or `windows` subdirectory that corresponds to the operating system on which you will be running the database scripts.
  - c. Navigate to the `sql_scripts` subdirectory.
  - d. Navigate to the RDBMS-specific directory that corresponds to your Info Mart database type (`db2`, `mssql`, or `oracle`).
  - e. Run the `migrate_gim.sql` script.
16. Run the SQL script that is provided with Genesys Info Mart release 7.6 to re-create the Genesys Info Mart read-only views.

---

**Notes:** The SQL script does not specify any particular logical or physical storage—for example, table spaces and partitions. Review and, if necessary, modify the SQL script to make sure that it is suitable for your deployment.

Also, see the note about schemas and owners under [Step 13](#) ([page 817](#)).

---

Use your RDBMS management tool to:

- a. Navigate to the `genesys_info_mart\db_scripts` subdirectory of the Genesys Info Mart 7.6 product CD.
  - b. Navigate to the `unix` or `windows` subdirectory that corresponds to the operating system on which you will be running the database scripts.
  - c. Navigate to the `sql_scripts` subdirectory.
  - d. Navigate to the RDBMS-specific directory that corresponds to your Info Mart database type (`db2`, `mssql`, or `oracle`).
  - e. Run the `make_gim_view.sql` script.
17. In a multi-tenant environment, run the SQL script that is provided with Genesys Info Mart release 7.6 to re-create the tenant-specific read-only views.

---

**Note:** Specify parameters for the owner ID and views owner ID.

---

Use your RDBMS management tool to:

- a. Navigate to the `genesys_info_mart\db_scripts` subdirectory of the Genesys Info Mart 7.6 product CD.
  - b. Navigate to the `unix` or `windows` subdirectory that corresponds to the operating system on which you will be running the database scripts.
  - c. Navigate to the `sql_scripts` subdirectory.
  - d. Navigate to the RDBMS-specific directory that corresponds to your Info Mart database type (`db2`, `mssql`, or `oracle`).
  - e. Run the `make_gim_view_for_tenant.sql` script once for each tenant that Genesys Info Mart monitors.
18. Re-create any custom database objects, such as views or indexes, or permissions that you created on top of the out-of-box Genesys Info Mart database objects. (You identified these objects and permissions in “Pre-Migration Procedure” on [page 811](#).)
  19. Create and update tables in the IDB(s) from which Genesys Info Mart extracts voice or Multimedia details.

Use your RDBMS management tool to execute the following SQL statements against each IDB with the Database Access Point (DAP) role equal to `ICON_CORE` or `ICON_MM`:

- For DB2:

```
ALTER TABLE GIM_IR_LIST
 ADD GSYS_MSEQ BIGINT;
CREATE TABLE GIM_IRID_LIST (
 IRID VARCHAR(50) NOT NULL,
 MERGE_STATE INTEGER,
 GSYS_EXT_INT1 INTEGER,
 GSYS_EXT_INT2 INTEGER,
 TERMINATED_TS INTEGER,
 GSYS_MSEQ BIGINT,
 HAS_STUCK_CALLS CHAR(1),
 CONSTRAINT PK_GIM_IRID_LIST PRIMARY KEY (IRID)
);
CREATE TABLE GIM_CALLID_LIST (
 CALLID VARCHAR(50) NOT NULL,
 IRID VARCHAR(50) NOT NULL,
 CONSTRAINT PK_GIM_CALLID_LIST PRIMARY KEY (CALLID)
);
CREATE TABLE GIM_PARTYID_LIST (
 PARTYID VARCHAR(50) NOT NULL,
 CALLID VARCHAR(50) NOT NULL,
 CONSTRAINT PK_GIM_CALLID_LIST PRIMARY KEY (PARTYID)
);
```

- For Microsoft SQL Server:

```

ALTER TABLE GIM_IR_LIST
 ADD GSYS_MSEQ BIGINT
go
CREATE TABLE GIM_IRID_LIST (
 IRID VARCHAR(50) NOT NULL,
 MERGE_STATE INTEGER,
 GSYS_EXT_INT1 INTEGER,
 GSYS_EXT_INT2 INTEGER,
 TERMINATED_TS INTEGER,
 GSYS_MSEQ BIGINT,
 HAS_STUCK_CALLS CHAR(1)
 CONSTRAINT PK_GIM_IRID_LIST PRIMARY KEY (IRID)
)
go
CREATE INDEX GIM_IRID_LIST_IDX on GIM_IRID_LIST (
 IRID ASC
)
go
CREATE TABLE GIM_CALLID_LIST (
 CALLID VARCHAR(50) NOT NULL,
 IRID VARCHAR(50) NOT NULL
 CONSTRAINT PK_GIM_CALLID_LIST PRIMARY KEY (CALLID)
)
go
CREATE INDEX GIM_CALLID_LIST_IDX on GIM_CALLID_LIST (
 CALLID ASC
)
go
CREATE TABLE GIM_PARTYID_LIST (
 PARTYID VARCHAR(50) NOT NULL,
 CALLID VARCHAR(50) NOT NULL
 CONSTRAINT PK_GIM_PARTYID_LIST PRIMARY KEY (PARTYID)
)
go
CREATE INDEX GIM_PARTYID_LIST_IDX on GIM_PARTYID_LIST (
 PARTYID ASC
)
go

```

- For Oracle:

```

ALTER TABLE GIM_IR_LIST
 ADD (GSYS_MSEQ NUMBER(20));
CREATE TABLE GIM_IRID_LIST (
 IRID VARCHAR2(50) NOT NULL,
 MERGE_STATE NUMBER(10),
 GSYS_EXT_INT1 NUMBER(10),
 GSYS_EXT_INT2 NUMBER(10),

```



```

 TERMINATED_TS NUMBER(10),
 GSYS_MSEQ NUMBER(20),
 HAS_STUCK_CALLS CHAR(1),
 CONSTRAINT PK_GIM_IRID_LIST PRIMARY KEY (IRID)
);
CREATE TABLE GIM_CALLID_LIST (
 CALLID VARCHAR2(50) NOT NULL,
 IRID VARCHAR2(50) NOT NULL,
 CONSTRAINT PK_GIM_CALLID_LIST PRIMARY KEY (CALLID)
);
CREATE TABLE GIM_PARTYID_LIST (
 PARTYID VARCHAR2(50) NOT NULL,
 CALLID VARCHAR2(50) NOT NULL,
 CONSTRAINT PK_GIM_PARTYID_LIST PRIMARY KEY (PARTYID)
);

```

20. Update indexes in IDB(s) from which Genesys Info Mart extracts voice or Multimedia details.

Use your RDBMS management tool to execute the following SQL statements against each IDB with the DAP role equal to ICON\_CORE or ICON\_MM:

---

**Note:** Ignore any error messages indicating that indexes cannot be dropped because they do not exist.

---

- For DB2 or Oracle:

```

DROP INDEX GIM_IDX_ASH_PSTATE;
DROP INDEX GIM_IDX_ASH_SEQ;
DROP INDEX GIM_IDX_ASH_STATE;
DROP INDEX GIM_IDX_ASH_SYSID;
DROP INDEX GIM_IDX_ASH_TSEQ;
DROP INDEX GIM_IDX_ASH_TYPE;
DROP INDEX GIM_IDX_ASH_USEQ;
DROP INDEX GIM_IDX_ASR_SEQ;
DROP INDEX GIM_IDX_ASR_USEQ;
DROP INDEX GIM_IDX_IR_MSTATE;

CREATE INDEX GIM_IDX_ASH_SEQ on G_AGENT_STATE_HISTORY (
 GSYS_SYS_ID ASC,
 GSYS_SEQ ASC,
 TYPE ASC,
 GSYS_EXT_INT1 ASC,
 ADDED_TS ASC
);
CREATE INDEX GIM_IDX_ASRC_SEQ on G_AGENT_STATE_RC (
 GSYS_SEQ ASC,
 CREATED_TS ASC
);

```

```

CREATE INDEX GIM_IDX_ASRC_SYSID on G_AGENT_STATE_RC (
 GSYS_SYS_ID ASC
);
CREATE INDEX GIM_IDX_GLS_SEQ on G_LOGIN_SESSION (
 GSYS_SEQ ASC
);
CREATE INDEX GIM_IDX_GLS_USEQ on G_LOGIN_SESSION (
 GSYS_USEQ ASC
);
CREATE INDEX GIM_IDX_GLS_SYSID on G_LOGIN_SESSION (
 GSYS_SYS_ID ASC
);
CREATE INDEX GIM_IDX_CALL_HA_LIST on G_CALL (
 IRID ASC,
 MEDIATYPE ASC,
 TENANTID ASC,
 CALLID ASC
);
CREATE INDEX GIM_IDX_PARTY_HA_LIST on G_PARTY (
 CALLID ASC,
 PARTYID ASC
);
CREATE INDEX GIM_IDX_IR_MSTATE on G_IR (
 GSYS_MSEQ ASC,
 MERGESTATE ASC,
 CREATED_TS ASC
);

```

- For Microsoft SQL Server:

```

DROP INDEX G_AGENT_STATE_HISTORY.GIM_IDX_ASH_PSTATE
go
DROP INDEX G_AGENT_STATE_HISTORY.GIM_IDX_ASH_SEQ
go
DROP INDEX G_AGENT_STATE_HISTORY.GIM_IDX_ASH_STATE
go
DROP INDEX G_AGENT_STATE_HISTORY.GIM_IDX_ASH_SYSID
go
DROP INDEX G_AGENT_STATE_HISTORY.GIM_IDX_ASH_TSEQ
go
DROP INDEX G_AGENT_STATE_HISTORY.GIM_IDX_ASH_TYPE
go
DROP INDEX G_AGENT_STATE_HISTORY.GIM_IDX_ASH_USEQ
go
DROP INDEX G_AGENT_STATE_RC.GIM_IDX_ASR_SEQ
go
DROP INDEX G_AGENT_STATE_RC.GIM_IDX_ASR_USEQ
go
DROP INDEX G_IR.GIM_IDX_IR_MSTATE
go

```

```
DROP INDEX G_USERDATA_HISTORY.GIM_IDX_UH_CALLID
go
DROP INDEX G_SECURE_USERDATA_HISTORY.GIM_IDX_SUH_CALLID
go
CREATE INDEX GIM_IDX_ASH_SEQ on G_AGENT_STATE_HISTORY (
 GSYS_SYS_ID ASC,
 GSYS_SEQ ASC,
 TYPE ASC,
 GSYS_EXT_INT1 ASC,
 ADDED_TS ASC
)
go
CREATE INDEX GIM_IDX_ASRC_SEQ on G_AGENT_STATE_RC (
 GSYS_SEQ ASC,
 CREATED_TS ASC
)
go
CREATE INDEX GIM_IDX_ASRC_SYSID on G_AGENT_STATE_RC (
 GSYS_SYS_ID ASC
)
go
CREATE INDEX GIM_IDX_GLS_SEQ on G_LOGIN_SESSION (
 GSYS_SEQ ASC
)
go
CREATE INDEX GIM_IDX_GLS_USEQ on G_LOGIN_SESSION (
 GSYS_USEQ ASC
)
go
CREATE INDEX GIM_IDX_GLS_SYSID on G_LOGIN_SESSION (
 GSYS_SYS_ID ASC
)
go
CREATE INDEX GIM_IDX_CALL_HA_LIST on G_CALL (
 IRID ASC,
 MEDIATYPE ASC,
 TENANTID ASC,
 CALLID ASC
)
go
CREATE INDEX GIM_IDX_PARTY_HA_LIST on G_PARTY (
 CALLID ASC,
 PARTYID ASC
)
go
```

```

CREATE INDEX GIM_IDX_IR_MSTATE on G_IR (
 GSYS_MSEQ ASC,
 MERGESTATE ASC,
 CREATED_TS ASC
)
go
CREATE INDEX GIM_IDX_UH_CALLID ON G_USERDATA_HISTORY (
 CALLID ASC,
 KEYID ASC,
 CHANGETYPE ASC
)
go
CREATE INDEX GIM_IDX_SUH_CALLID ON G_SECURE_USERDATA_HISTORY (
 CALLID ASC,
 KEYID ASC,
 CHANGETYPE ASC
)
go

```

**21.** Update indexes in the IDB(s) from which Genesys Info Mart extracts Multimedia details.

Use your RDBMS management tool to perform the following actions against each IDB with the DAP role equal to ICON\_MM.

**a.** Execute the following SQL statements:

- For DB2 or Oracle:

```

DROP INDEX GIM_IDX_GMF_SEQ;
DROP INDEX GIM_IDX_GMF_USEQ;
DROP INDEX GIM_IDX_GML_SEQ;
DROP INDEX GIM_IDX_GML_USEQ;
DROP INDEX GIM_IDX_PAR_SEQ;
DROP INDEX GIM_IDX_PAR_USEQ;
DROP INDEX GIM_IDX_PHIS_SEQ;
DROP INDEX GIM_IDX_PHIS_USEQ;
DROP INDEX GIM_IDX_PST_SEQ;
DROP INDEX GIM_IDX_PST_USEQ;
DROP INDEX GIM_IDX_RR_SEQ;
DROP INDEX GIM_IDX_RR_USEQ;
DROP INDEX GIM_IDX_UH_SEQ;
DROP INDEX GIM_IDX_UH_USEQ;
DROP INDEX GIM_IDX_SUH_SEQ;
DROP INDEX GIM_IDX_SUH_USEQ;

```

- For Microsoft SQL Server:

```

DROP INDEX GM_F_USERDATA.GIM_IDX_GMF_SEQ
go
DROP INDEX GM_F_USERDATA.GIM_IDX_GMF_USEQ
go
DROP INDEX GM_L_USERDATA.GIM_IDX_GML_SEQ
go

```

```

DROP INDEX GM_L_USERDATA.GIM_IDX_GML_USEQ
go
DROP INDEX G_PARTY.GIM_IDX_PAR_SEQ
go
DROP INDEX G_PARTY.GIM_IDX_PAR_USEQ
go
DROP INDEX G_PARTY_HISTORY.GIM_IDX_PHIS_SEQ
go
DROP INDEX G_PARTY_HISTORY.GIM_IDX_PHIS_USEQ
go
DROP INDEX G_PARTY_STAT.GIM_IDX_PST_SEQ
go
DROP INDEX G_PARTY_STAT.GIM_IDX_PST_USEQ
go
DROP INDEX G_ROUTE_RESULT.GIM_IDX_RR_SEQ
go
DROP INDEX G_ROUTE_RESULT.GIM_IDX_RR_USEQ
go
DROP INDEX G_USERDATA_HISTORY.GIM_IDX_UH_SEQ
go
DROP INDEX G_USERDATA_HISTORY.GIM_IDX_UH_USEQ
go
DROP INDEX G_SECURE_USERDATA_HISTORY.GIM_IDX_SUH_SEQ
go
DROP INDEX G_SECURE_USERDATA_HISTORY.GIM_IDX_SUH_USEQ
go

```

- b. Navigate to the `genesys_info_mart\db_scripts` subdirectory of the Genesys Info Mart 7.6 product CD.
  - c. Navigate to the `unix` or `windows` subdirectory that corresponds to the operating system on which you will be running the database scripts.
  - d. Navigate to the `sql_scripts` subdirectory.
  - e. Navigate to the RDBMS-specific directory that corresponds to the IDB database type (`db2`, `mssql`, or `oracle`).
  - f. Run the `make_iconmm_indexes_for_gim.sql` script.
22. Add indexes in IDB(s) from which Genesys Info Mart extracts Outbound Contact Solution (OCS) details.

Use your RDBMS management tool to perform the following actions against each IDB with the DAP role equal to `ICON_OCS`:

- a. Navigate to the `genesys_info_mart\db_scripts` subdirectory of the Genesys Info Mart 7.6 product CD.
- b. Navigate to the `unix` or `windows` subdirectory that corresponds to the operating system on which you will be running the database scripts.
- c. Navigate to the `sql_scripts` subdirectory.
- d. Navigate to the RDBMS-specific directory that corresponds to the IDB database type (`db2`, `mssql`, or `oracle`).
- e. Run the `make_icon_ocs_indexes_for_gim.sql` script.

- 23.** If you are running a multi-IDB topology with a Merge Staging Area configured, update indexes and primary key definitions.

Use your RDBMS management tool to perform the following actions against the Merge Staging Area database:

- a. Navigate to the `genesys_info_mart\db_scripts` subdirectory of the Genesys Info Mart 7.6 product CD.
  - b. Navigate to the `unix` or `windows` subdirectory that corresponds to the operating system on which you will be running the database scripts.
  - c. Navigate to the `sql_scripts` subdirectory.
  - d. Navigate to the RDBMS-specific directory that corresponds to the Staging Area database type (`db2`, `mssql`, or `oracle`).
  - e. Run the `upgrade_merging_to_76006.sql` script.
- 24.** Run the Genesys Info Mart 7.6 Configuration Checker utility to verify your configuration option settings and database connectivity.
- See the chapter about post-installation activities in the *Genesys Info Mart 7.6 Deployment Guide*.
- 25.** Use SCI to start the Genesys Info Mart 7.6 Server process.
- 26.** From the Genesys Info Mart Administration Console 7.6, run `Job_MigrateGIM`, specifying the `<ALL SOURCES>` DAP. Started in this manner, the migration job will perform all critical data migration that is required before you can resume ETL processing.
- The Genesys Info Mart Administration Console will indicate when the migration job has completed successfully:
- A successful completion of the job means that all data from the critical tables has been migrated.
  - If `Job_MigrateGIM` fails to complete, the log file that Genesys Info Mart Server generates will indicate the cause of the failure. After you correct the issue that caused the failure, use the Genesys Info Mart Administration Console to re-run `Job_MigrateGIM`. The job will resume where it left off.
- 27.** Configure the Genesys Info Mart 7.6 to run the `Job_MigrateGIM` as a daily job. Started in this manner, the migration job will perform the data migration that is not critical to be completed before you resume ETL processing.
- To do so, set the configuration options that control `Job_MigrateGIM` in `schedule` section of the Genesys Info Mart Application object:
- `run-migration` (which is set to `FALSE` by default)
  - `migration-start-time` (which is set to `04:00` by default)
  - `migration-duration-in-hours` (which is set to `1` by default)

---

**Note:** If you set the `migration-duration-in-hours` option to `0`, the migration job will run until all data is migrated; however, this process may take a long time and delay regular Genesys Info Mart operations. To decide whether migration of the non-critical data in one run is acceptable for your environment, review the “`Job_MigrateGIM`” section of the *Genesys Info Mart 7.6 Operations Guide*.

---

For complete descriptions of these options, including their valid values, refer to the section about configuring Genesys Info Mart options in *Genesys Info Mart 7.6 Deployment Guide*.

---

**Note:** If `Job_MigrateGIM` fails to complete, the log file that Genesys Info Mart Server generates will indicate the cause of the failure. After you correct the issue that caused the failure, use the Genesys Info Mart Administration Console to re-run `Job_MigrateGIM`. The job will resume where it left off.

---

28. Start the Genesys Info Mart 7.6 Scheduler by setting the `run-scheduler` configuration option to `TRUE` in the `schedule` section of the Genesys Info Mart `Application` object.

---

**Note:** At this point, you have completed the critical migration. It is now safe to resume ETL execution by using the 7.6 ETL jobs. It is also now safe to access the Info Mart database to produce reports and run other scheduled activities, such as custom aggregation.

---

29. Use the Genesys Info Mart Administration Console 7.6 to monitor whether Genesys Info Mart 7.6 ETL jobs are completing successfully, as scheduled.

30. Use your RDBMS management tool to issue the following SQL statement against the Info Mart database schema in order to determine that `Job_MigrateGIM` has completed the migration of all non-critical data:

```
SELECT
 TABLE_NAME, COMPLETED_FLAG
FROM
 DATA_MIGRATION;
```

When all table values return `COMPLETED_FLAG=1`, the data migration is complete.

31. After you have verified that `Job_MigrateGIM` has completed performing all non-critical data migration, configure the Genesys Info Mart Server not to run `Job_MigrateGIM` as a daily job. To do so, set the `run-migration` configuration option to `FALSE` in the `schedule` section of the Genesys Info Mart `Application` object.

32. To complete the migration process, run the SQL script that is provided with Genesys Info Mart release 7.6 to create the Genesys Info Mart read-only views in place of certain tables, for backward compatibility, and reset database constraints for the Info Mart database.
  - a. Use SCI to temporarily stop the Genesys Info Mart 7.6 Server process.
  - b. Use the Genesys Info Mart Administration Console 7.6 to monitor completion of any running ETL jobs.
  - c. Use your RDBMS management tool to navigate to the `genesys_info_mart\db_scripts` subdirectory of the Genesys Info Mart 7.6 product CD.
  - d. Navigate to the `unix` or `windows` subdirectory corresponding to the operating system on which you will be running the database scripts.
  - e. Navigate to the `sql_scripts` subdirectory.
  - f. Navigate to the RDBMS-specific directory that corresponds to your Info Mart database type (`db2`, `mssql`, or `oracle`).
  - g. Run the `migrate_gim_done.sql` script against the Info Mart database.
  - h. Use SCI to start the Genesys Info Mart 7.6 Server process.
  - i. Use the Genesys Info Mart Administration Console 7.6 to verify that Genesys Info Mart 7.6 starts launching ETL jobs successfully.

---

**Note:** At successful completion of the migration job, adjustments to the technical descriptor keys are completed as well. If you are migrating from release 7.5.005 (or a later 7.5 release) to release 7.6.003 (or a later 7.6 release), make any additional adjustments, if necessary, to your custom fact, summary, and aggregate tables that are dependent on the technical descriptor keys.

---

---

## Migrating Genesys Info Mart from 7.2.x to 7.6.x

This section describes the steps that are required to migrate Genesys Info Mart and supporting software from release 7.2.x to release 7.6.x.

Migrating Genesys Info Mart from release 7.2.x to release 7.6.x requires a two-step migration process:

1. Migrate Genesys Info Mart from release 7.2.x to 7.5.x (see “Migrating Genesys Info Mart from 7.2.x to 7.5.x” on [page 829](#)).
2. Migrate Genesys Info Mart from release 7.5.x to 7.6.x (see “Migrating Genesys Info Mart from 7.5.x to 7.6.x” on [page 810](#)).



---

## Migrating Genesys Info Mart from 7.0.2 to 7.6.x

This section describes the steps that are required to migrate Genesys Info Mart and supporting software from release 7.0.2 to release 7.6.x.

Migrating Genesys Info Mart from release 7.0.2 to release 7.6.x requires a three-step migration process:

1. Migrate Genesys Info Mart from release 7.0.2 to 7.2.x (see “Migrating Genesys Info Mart from 7.0.2 to 7.2.x” on [page 837](#)).
2. Migrate Genesys Info Mart from release 7.2.x to 7.5.x (see “Migrating Genesys Info Mart from 7.2.x to 7.5.x” on [page 829](#)).
3. Migrate Genesys Info Mart from release 7.5.x to 7.6.x (see “Migrating Genesys Info Mart from 7.5.x to 7.6.x” on [page 810](#)).

---

## Migrating Genesys Info Mart from 7.2.x to 7.5.x

This section describes the steps that are required to migrate Genesys Info Mart and supporting software from release 7.2.x to release 7.5.x.

---

**Note:** Genesys Info Mart 7.5 is considered a major software release that contains many architectural changes and functional enhancements. Genesys *strongly* recommends that you carefully plan and practice migrating to Genesys Info Mart 7.5 in a non-production environment *before* you perform the migration in your production environment.

It is important also that you test the population of new data in your non-production environment, to ensure compatibility with your current reporting application SQL queries—particularly for Genesys Info Mart facts and dimensions that are populated from attached data key-value pairs that are extracted from ICON data sources.

---

### Migration Planning

1. Perform any necessary operating system upgrades. For information about the operating system versions that Genesys Info Mart 7.5 supports, see *Genesys Supported Operating Environment Reference Manual*.

2. Perform any necessary relational database management system (RDBMS) client and server upgrades. For information about the RDBMS versions that Genesys Info Mart 7.5 supports, see *Genesys Supported Operating Environment Reference Manual*.
3. Review the *Genesys Info Mart 7.5 Release Advisory* for information about known operating system and RDBMS issues, and potential ways to work around these issues.
4. Determine the version of the Java Development Kit (JDK) that is installed. Genesys Info Mart requires a Java 1.5 JDK version that supports the 2007 changes to the U.S. daylight saving time. (Consult your Java vendor for details.) For more information, see the section about software requirements in the *Genesys Info Mart 7.5 Deployment Guide*.
5. Determine whether a Java Database Connectivity (JDBC) driver is installed for your RDBMS. Genesys Info Mart 7.5 requires you to install a JDBC driver for your RDBMS. For more information about supported JDBC drivers and how to install and configure them for Genesys Info Mart, see the section about preparing the Genesys Info Mart Server host in the *Genesys Info Mart 7.5 Deployment Guide*.
6. Upgrade your Interaction Concentrator to release 7.5 if you are using Interaction Concentrator 7.2 to collect Outbound Contact Solution (OCS) data for Genesys Info Mart. Make sure to perform this upgrade at a time when there are no active campaign sessions in progress.
7. Create a new database schema for the Merge Staging Area if you intend to extract Voice interaction data from multiple Interaction Concentrator Interaction Databases (IDBs).
8. Review the data-size estimates for the Staging Area database in the *Genesys Info Mart 7.5 Database Size Estimator*. The 7.5 release stores more data than the 7.2 release; therefore, if necessary, allocate more physical database storage.
9. Review the data-size estimates for the Info Mart 7.5 database in the *Genesys Info Mart 7.5 Database Size Estimator*. The 7.5 release stores more data than the 7.2 release; therefore, if necessary, allocate more physical database storage.
10. The extraction, transformation, and loading (ETL) jobs that ship with Genesys Info Mart 7.5 differ from those in previous releases. To plan an ETL job schedule that is suitable for your environment, review the descriptions of the Genesys Info Mart 7.5 ETL jobs—and how to schedule them—in the section about data transformation in the *Genesys Info Mart 7.5 Operations Guide*.
11. Plan a time when you can complete this migration. Several of the steps can take a significant amount of time to complete, which might affect the availability of Info Mart data.

## Pre-Migration Procedure

Identify any custom changes that you made to the Genesys Info Mart 7.2 Staging Area and Info Mart databases—for example, table spaces, partitions, additional indexes, views, or permissions. This includes the permissions or privileges that you granted to the users of the Staging Area and Info Mart databases, as described in the section about database privileges in the Genesys Info Mart 7.5 Deployment Guide.

The Genesys Info Mart SQL scripts that you will run to update these databases sometimes create new tables, instead of updating the old tables. You will need to re-create any custom database objects or permissions that become lost or invalidated during the update process.

## Migration Procedure

1. From Configuration Manager, create and configure Interaction Concentrator 7.5 Application objects(s) to replace all of the following:
  - Your existing Call Concentrator source(s) (role is gcc).
  - Your Stat Server data sources that collect resource session information (role is gls).

---

**Note:** Stat Server will continue to populate voice resource states and reasons.

---

- Your Configuration data source (role is cfg).

For information about configuring the Interaction Concentrator application, see the section about preparing Interaction Concentrator in the *Genesys Info Mart 7.5 Deployment Guide*.

2. Install the Interaction Concentrator 7.5 applications that you configured in [Step 1](#). The Interaction Concentrator installation will require you to install other Genesys 7.5 software—for example, Framework T-Server and Outbound Contact Solution (OCS).

For information about deploying Interaction Concentrator, see the *Interaction 7.5 Deployment Guide* and the *Genesys 7 Migration Guide*.

3. For each IDB from which Genesys Info Mart will extract Voice or Multimedia details (role is gcc or gls), run the `make_icon_indexes_for_gim.sql` script.
4. Modify the sample `ccon_adata_spec.xml` file, which is included in the Genesys Info Mart installation package, to define the mappings between key-value pairs that are stored in the IDB tables and the Info Mart database. See the section about customizing your `ccon_adata_spec` file in the *Genesys Info Mart 7.5 Deployment Guide*.

---

**Note:** This step must be repeated for each Interaction Concentrator that is recording Voice or Multimedia details (`role` is `gcc`).

---

5. If you are using Interaction Concentrator 7.2 to collect Outbound Contact Solution (OCS) data for Genesys Info Mart, upgrade your Interaction Concentrator to release 7.5. Make sure to perform this upgrade at a time when there are no active campaign sessions in progress.
6. Start your Interaction Concentrator 7.5 application(s).

---

**Note:** It is important to start Interaction Concentrator(s) 7.5 at this point in the migration, in order to begin collecting contact center information. This will ensure that no information is missed during the transition between Call Concentrator and Interaction Concentrator 7.5. Make a note of when you start the Interaction Concentrator 7.5 application(s). (This date will be needed in [Step 29](#)).

---

7. Create a new database schema for the Merge Staging Area if you intend to have Genesys Info Mart process voice details from multiple Interaction Concentrator IDBs. To do this, run the Interaction Concentrator IDB initialization scripts against the Staging Area database. For instructions on how to run the scripts, see the *Interaction Concentrator 7.5 Deployment Guide*.
8. Create a new Genesys Info Mart Application object in Genesys Configuration Manager using the Genesys Info Mart 7.5 application template. See the chapter about configuring the Genesys Info Mart application in the *Genesys Info Mart 7.5 Deployment Guide*.
9. Configure your Genesys Info Mart Application object. For more information about the configuration options, see the section about configuring Genesys Info Mart options in the *Genesys Info Mart 7.5 Deployment Guide*.
10. Configure the scheduling of the Genesys Info Mart 7.5 ETL jobs. See [Step 10](#) on [page 830](#), and the section about data transformation in the *Genesys Info Mart 7.5 Operations Guide*. To prevent the ETL jobs from running until later in the migration process, set the `run-scheduler` option to `FALSE`.
11. Create and configure JDBC Database Access Points (DAPs) to access the Staging Area, Info Mart, and Interaction Concentrator databases. You will also need to create and configure JDBC DAPs for any Stat Server database from which Genesys Info Mart will be extracting voice resource data.  
For information about configuring DAPs and DAP options, see the chapter about configuring DAPs for Genesys Info Mart in the *Genesys Info Mart 7.5 Deployment Guide*. Refer also to the database connection

parameters that you noted in the appropriate section of the Installation Checklist in the *Genesys Info Mart 7.5 Deployment Guide*.

12. Create a non-JDBC DAP to access the Staging Area database from the Genesys Info Mart Administration Console. See the section about configuring a non-JDBC DAP in the *Genesys Info Mart 7.5 Deployment Guide*.
13. Perform any additional configuration for any DAPs created in [Step 11](#) that are associated with an IDB in the HA pair (in Genesys Info Mart 7.5) that replaces the Call Concentrator HA pair (in Genesys Info Mart 7.2). For more information, see the section about configuring DAPs for high availability in the *Genesys Info Mart 7.5 Deployment Guide*.
14. On the **Connections** tab of your Genesys Info Mart application, add a connection to each of the DAP **Application** objects created in [Step 11](#). For more information, see the section about configuring the Genesys Info Mart application in the *Genesys Info Mart 7.5 Deployment Guide*.
15. Allow the Genesys Info Mart 7.2 ETL jobs to finish a final ETL cycle.
16. Use the Solution Control Server (SCS) to stop Genesys Info Mart Server so that the 7.2 ETL jobs do not automatically start again. If you are using Data Integrator Web Administrator to schedule jobs, disable the job schedules.

---

**Note:** It is very important that you allow Call Concentrator to continue running until the migration is complete, and until you are sure that new call details are being processed correctly from Interaction Concentrator by Genesys Info Mart 7.5.

---

17. Use the Data Integrator Web Administrator to manually run the following jobs, until all the extracted data has been transformed and loaded:
  - a. JOB\_TransformGIM
  - b. JOB\_LoadRecent
  - c. JOB\_LoadGIM

---

**Note:** You can use the ADMIN\_LOAD\_HISTORY view to help determine when all of the data has been loaded by making sure that for all fact tables the row\_count\_add and row\_count\_update columns are 0.

---

### Back Up Staging Area and Info Mart Databases

18. Back up the Staging Area and Info Mart databases. The Info Mart database can be restored into a new schema and used for reporting purposes during the remainder of the migration process or during your verification of successful migration.

19. Upgrade your Stat Server(s) to release 7.1.000.10 (or later), if your Stat Server release is earlier than 7.1.000.10. Make sure that the `status-table-update-end-time-at-end-only` configuration option is set to `TRUE` in the `statserver` section of the Stat Server Application object(s).
20. Install a version of Java 1.5 JDK that supports the 2007 changes to U.S. daylight saving time. For more information, see the section about software requirements in the *Genesys Info Mart 7.5 Deployment Guide*.
21. On the Genesys Info Mart Server:
  - a. Install the appropriate JDBC driver for your RDBMS, which corresponds to the database type of the IDB, Stat Server, Staging Area, Merge Staging Area, and Info Mart databases.

---

**Note:** Genesys Info Mart 7.5 uses JDBC drivers that are installed on the Job Server to communicate with the data source and Info Mart databases.

---

- b. Make the JDBC driver available for use by Genesys Info Mart by including it in the `CLASSPATH` environment variable. For more information, see the section about installing JDBC drivers in the *Genesys Info Mart 7.5 Deployment Guide*.
22. Run the SQL script to update the Staging Area database schema.

---

**Notes:** Make sure that you back up your 7.2 Staging Area database before you run the migration script. This step can take a long time, depending on the amount of data in the database.

It is very important that you run the migration scripts against the original 7.2 Staging Area database and not against the backup one.

Also make sure that you turn on database session logging, so that if the script fails before it is finished, it will be easy for you to determine which statements have been completed successfully; then, you can eliminate these from the script before you restart it.

---

From the Genesys Info Mart CD-ROM:

- a. Navigate to the `genesys_info_mart\db_scripts` subdirectory.
- b. Navigate to the `unix` or `windows` subdirectory corresponding to the operating system on which you will be running the database scripts.
- c. Navigate to the `sql_scripts` subdirectory.
- d. Navigate to the RDBMS-specific directory that corresponds to your Staging Area database type (`db2`, `mssql`, or `oracle`).
- e. Run: `migrate_gim_staging_area.sql`.

---

**Note:** The SQL scripts do not qualify database objects according to their schema or owner. When you run the SQL scripts, make sure that you use the ID of the schema or owner to log in to the database. You noted this information in the appropriate section of the installation checklist in the *Genesys Info Mart 7.5 Deployment Guide*.

---

**23.** Run the SQL script to update the Info Mart database schema.

**Notes:** Make sure that you back up your 7.2 Info Mart database before you run the migration script. This step can take a long time, depending on the amount of data in the database.

It is very important that you run the migration scripts against the original 7.2 Info Mart database and not against the backup one.

Also make sure that you turn on database session logging, so that if the script fails before it is finished, it will be easy for you to determine which statements have completed successfully; then, you can eliminate these from the script before you restart it.

---

From the Genesys Info Mart CD-ROM:

- a. Navigate to the `genesys_info_mart\db_scripts` subdirectory.
- b. Navigate to the `unix` or `windows` subdirectory corresponding to the operating system on which you will be running the database scripts.
- c. Navigate to the `sql_scripts` subdirectory.
- d. Navigate to the RDBMS-specific directory that corresponds to your Info Mart database type (`db2`, `mssql`, or `oracle`).
- e. Run `migrate_gim.sql`.

**Notes:** The SQL script does not specify any particular logical or physical storage—for example, table spaces and partitions. Review and, if necessary, modify the SQL script, to make sure that it is suitable for your deployment.

See also the note about schemas and owners under [Step 22](#).

---

**24.** Run the Genesys Info Mart 7.5 `make_gim_view.sql` and `make_gim_tenant_view.sql` scripts, to re-create the read-only views and the tenant-specific read-only views on the Info Mart database. Specify parameters for the owner ID and views owner ID.

These `.sql` scripts are included on the Genesys Info Mart 7.5 CD-ROM in the same subdirectories as the migration scripts that were run in [Steps 22](#) and [23](#).

25. Re-create any custom database objects or permissions that become lost or invalidated during the migration process. (You identified these objects and permissions in “Pre-Migration Procedure” on [page 831](#).)
26. Install the Genesys info Mart 7.5 application:
  - a. Run the installation program to copy files to the installation directory.
  - b. Run the Configuration Checker program to validate your configuration option values.

See the chapters about installing Genesys Info Mart components and post-installation activities in the *Genesys Info Mart 7.5 Deployment Guide*.

27. Install the Genesys Info Mart 7.5 Administration Console on the same host as your Genesys Configuration Manager.

The Genesys Info Mart Administration Console is a graphical user interface (GUI) that enables the monitoring and real-time administration of some aspects of the Genesys Info Mart ETL jobs. It is accessed through the Genesys Info Mart application in Configuration Manager. See the section about installing the Genesys Info Mart Administration Console in the *Genesys Info Mart 7.5 Deployment Guide*.

---

**Note:** The Genesys Info Mart Administration Console requires a non-JDBC DAP in order to access the Staging Area database. See [Step 12](#) on [page 833](#).

---

28. Run the Genesys Info Mart 7.5 ETL jobs one-by-one. Use the Genesys Info Mart Administration Console to run them for the first time, rather than scheduling them to run. For complete instructions see the section about executing and scheduling ETL jobs in the *Genesys Info Mart 7.5 Operations Guide*.
29. Run the `mark_duplicate_gim_facts.sql` script against the Info Mart database. This will set the `purge_flag` to 1 for duplicate facts that were recorded when Interaction Concentrator and Call Concentrator or Stat Server processed the same information during a period of time in the migration process. `JOB_MaintainGIM` will then physically delete these marked rows from the Info Mart database the next time it is run if the value of the `purge-action-is-delete` configuration option is set to TRUE.

---

**Note:** This script requires that you input the date on which you started Interaction Concentrator 7.5 (see [Step 6](#)).

---

30. After the successful initial run of the Genesys Info Mart 7.5 ETL jobs, set the `run-scheduler` option to TRUE to enable the Genesys Info Mart Server to schedule the jobs. See the section about using Genesys Info Mart Server to launch ETL jobs in the *Genesys Info Mart 7.5 Operations Guide*.



31. When you are satisfied that Genesys Info Mart 7.5 is working properly:
  - a. Delete the Genesys Info Mart 7.2 Application object from Configuration Manager.
  - b. Uninstall the Genesys Info Mart 7.2 application.
  - c. Use your RDBMS database-specific tool to delete the Genesys Info Mart 7.2 local repository.
  - d. Uninstall Data Integrator on any host on which you ran Data Integrator Designer or Data Integrator Job Server.

---

## Migrating Genesys Info Mart from 7.0.2 to 7.5.x

This section describes the steps required to migrate Genesys Info Mart and supporting software from release 7.0.2 to release 7.5.x.

Migrating Genesys Info Mart from release 7.0.2 to release 7.5.x requires a two-step migration process:

1. Migrate Genesys Info Mart from release 7.0.2 to 7.2.x (see “Migrating Genesys Info Mart from 7.0.2 to 7.2.x” on [page 837](#)).
2. Migrate Genesys Info Mart from release 7.2.x to 7.5.x (see “Migrating Genesys Info Mart from 7.2.x to 7.5.x” on [page 829](#)).

---

## Migrating Genesys Info Mart from 7.0.2 to 7.2.x

This section describes the steps required to migrate Genesys Info Mart and supporting software from release 7.0.2 to release 7.2.x.

### Migration Planning

1. Review the list of new features in Genesys Info Mart 7.2 (see “Content Changes in Genesys Info Mart 7.2” on [page 772](#)), and determine which feature you want to implement.
2. Perform any necessary operating system upgrades. For information about the operating system versions that Genesys Info Mart 7.2 supports, see *Genesys Supported Operating Environment Reference Manual*.
3. Perform any necessary relational database management system (RDBMS) client and server upgrades. For information about the RDBMS versions Genesys Info Mart 7.2 supports, see *Genesys Supported Operating Environment Reference Manual*.

4. Review the *Genesys Info Mart 7.2 Release Advisory* for information about known Data Integrator, operating system, and RDBMS issues, and potential ways to work around these issues.
5. Review the *Genesys Info Mart 7.2 Release Notes* for important information about this Genesys Info Mart version.
6. Genesys Info Mart requires a version of Java 1.5 JDK that supports the 2007 changes to the U.S. daylight saving time. (Consult your Java vendor for details.) For more information, see the section about software requirements in the *Genesys Info Mart Deployment Guide*.
7. Determine whether a Java Database Connectivity (JDBC) driver is installed for your RDBMS. Genesys Info Mart 7.2 requires you to install a JDBC driver for your RDBMS. For more information about supported JDBC drivers, and how to install and configure them for Genesys Info Mart, see the section about JDBC drivers in the *Genesys Info Mart Deployment Guide*.
8. If you want to use Genesys Solution Control to start and stop the Genesys Info Mart Server, install Local Control Agent (LCA) 7.x on the host where you plan to install Genesys Info Mart.
9. Upgrade your Configuration Server to release 7.2.000.06 (or later) if you intend to have Genesys Info Mart populate the membership of agents among skill expression-based virtual agent groups in the Resource Group Fact table.
10. Consider upgrading Call Concentrator(s) to the latest Genesys 7 maintenance release. Although this is an optional task, upgrading to the latest maintenance release will enable Genesys Info Mart to produce higher-quality data.
11. Upgrade Stat Server(s) to release 7.2 if you intend to have Genesys Info Mart populate agent DN work modes and reason codes in its Resource State Reason Fact table. This release also supplies the `status-table-update-end-time-at-end-only` configuration option (initially available in Stat Server 7.1.000.10) that is required if you intend to have Genesys Info Mart perform intraday loading. This option allows you to set lower values for Genesys Info Mart's `etl-frequency` and `data-source-lag` options, resulting in decreased data latency.
12. Install Interaction Concentrator 7.2 if you intend to have Genesys Info Mart populate Outbound Contact Solution-related fact and dimension tables. Interaction Concentrator requires you to install other Genesys 7.2 software, such as Framework T-Server and Outbound Contact Solution. For information about deploying Interaction Concentrator, see the *Interaction Concentrator Deployment Guide*.

For information about configuring the Interaction Concentrator application, see the sections about the Interaction Concentrator application and Genesys Info Mart and OCS record field data in the *Genesys Info Mart Deployment Guide*. Genesys Info Mart also relies on a new key-value pair

attached to voice interactions by Outbound Contact Server 7.2 (or your agent desktop for Preview dialing campaigns). See “Modifying Your Call Concentrator Database” on [page 848](#) for more information.

13. Review the Staging Area database’s data-size estimates in the *Genesys 7 Hardware Sizing Guide* for Genesys Info Mart 7.2. The 7.2 release stores more data than the 7.0.2 release; therefore, if necessary, allocate more physical database storage.
14. Review the data-size estimates for the Info Mart 7.2 database in the *Genesys 7 Hardware Sizing Guide*. The 7.2 release stores more data than version 7.0.2 release; therefore, if necessary, allocate more physical database storage.
15. Genesys Info Mart 7.2 ships with Business Objects Data Integrator 11.0.2. You will be guided through the process to upgrade from Data Integrator 6.5.1 in “Migration Procedure” on [page 841](#).
16. The extraction, transformation, and loading (ETL) jobs that ship with Genesys Info Mart 7.2 differ from those in release 7.0.2. Genesys Info Mart 7.2 also uses a new job scheduler—Genesys Info Mart Server. To plan an ETL job schedule that is suitable for your environment, review the descriptions of the Genesys Info Mart 7.2 ETL jobs—and how to schedule them—in the section about data transformation in the *Genesys Info Mart Operations Guide*.
17. Plan a time when you can complete the migration. Several of the steps can take a significant amount of time to complete, which might affect the availability of Info Mart data.

## Pre-Migration Procedure

1. Allow the Genesys Info Mart 7.0.2 ETL jobs to finish their final extract, transform, and load. Once the transform and load jobs have finished, do not allow another extract to run. Extracted data in the Staging Area database that has not been transformed and loaded into the Info Mart database will be lost when you install Genesys Info Mart 7.2. Use the Data Integrator Web Administrator to deactivate the ETL job schedules, so that the 7.0.2 ETL jobs do not run again. To deactivate the schedules:
  - a. Log in to the Data Integrator Web Administrator.
  - b. In the navigation tree, click **Batch** to display the list of Data Integrator local repositories.
  - c. In the navigation tree, click the local repository name to display the ETL job status.
  - d. Click the **Configuration** tab.
  - e. For each job, click **Schedules**, select the **Select All** check box to select all schedules, and click the **Deactivate** button to deactivate the selected schedules.

For more information on scheduling jobs, refer to the section about scheduling jobs in the *Data Integrator Administrator Guide*.

2. Create a new database schema for the Data Integrator 11.0.2 local repository. This repository will store the Genesys Info Mart 7.2 ETL job metadata. For information about how to create this database, see the section about pre-installation tasks in the *Genesys Info Mart Deployment Guide*.

---

**Warning!** The Staging Area and Info Mart databases are critical resources. Make sure to back up your data to prevent any loss or corruption that might accidentally occur during the migration process.

---

- |                                            |                                                                                                                                                                                                                                                                                                                                                                                                                                                                                                                                                                                                                                                                                                                                                                                                                                                                                                                                |
|--------------------------------------------|--------------------------------------------------------------------------------------------------------------------------------------------------------------------------------------------------------------------------------------------------------------------------------------------------------------------------------------------------------------------------------------------------------------------------------------------------------------------------------------------------------------------------------------------------------------------------------------------------------------------------------------------------------------------------------------------------------------------------------------------------------------------------------------------------------------------------------------------------------------------------------------------------------------------------------|
| <b>Back Up Local Repository</b>            | 3. Back up your Genesys Info Mart 7.0.2 Local Repository database.                                                                                                                                                                                                                                                                                                                                                                                                                                                                                                                                                                                                                                                                                                                                                                                                                                                             |
| <b>Back Up 7.0.2 Staging Area Database</b> | 4. Back up your Genesys Info Mart 7.0.2 Staging Area database. This can take a significant amount of time and storage, depending on the amount of data that has accumulated in the Staging Area database.                                                                                                                                                                                                                                                                                                                                                                                                                                                                                                                                                                                                                                                                                                                      |
| <b>Back Up 7.0.2 Info Mart Database</b>    | 5. Back up your Genesys Info Mart 7.0.2 Info Mart database. This may take a significant amount of time and storage, depending on how much data has accumulated in the Info Mart database.                                                                                                                                                                                                                                                                                                                                                                                                                                                                                                                                                                                                                                                                                                                                      |
| <b>Back Up 7.0.2 SQL Scripts</b>           | 6. Create backup copies of the Genesys Info Mart 7.0.2 deployment SQL scripts that you modified and ran when you deployed Genesys Info Mart 7.0.2. These SQL scripts perform the following tasks: <ol style="list-style-type: none"> <li>a. Create or modify source Call Concentrator and Stat Server databases.</li> <li>b. Create the Call Concentrator EVREFEX extraction view.</li> <li>c. Create the target Staging Area and Info Mart databases.</li> <li>d. Create the Info Mart read-only views.</li> </ol> <p>The Genesys Info Mart 7.2 installation program overwrites these SQL scripts, and it does not preserve your modifications.</p> <p>To locate these SQL scripts, navigate to the Genesys Info Mart installation directory, and to its <code>sql_scripts</code> subdirectory. The SQL scripts are in the RDBMS-specific subdirectories (<code>db2</code>, <code>mssql</code>, and <code>Oracle</code>).</p> |
|                                            | 7. Identify any custom changes that you made to the Staging Area and Info Mart databases—for example, table spaces, partitions, additional indexes, views, or permissions. This includes the permissions or privileges that you granted to the users of the Staging Area and Info Mart databases, as described in the section about database privileges in the <i>Genesys Info Mart Deployment Guide</i> .                                                                                                                                                                                                                                                                                                                                                                                                                                                                                                                     |
- The Genesys Info Mart SQL scripts that you will run to update these databases sometimes create new tables, instead of updating the old tables. You will need to re-create any custom database objects or permissions that become lost or invalidated during the update process.

**Back Up  
Configuration  
Options**

8. Create a backup copy of your Genesys Info Mart application's configuration options, using the following procedure:
  - a. Log in to Genesys Configuration Manager.
  - b. Click the `Options` tab of the Genesys Info Mart Application object.
  - c. Click `Export to Configuration File`.
  - d. Type a target file name, and then click `Save`.

## Migration Procedure

1. Uninstall Data Integrator 6.5.1 on any hosts where you run Data Integrator Designer or Data Integrator Job Server:
  - a. Record the names and port numbers of your existing Job Servers.
  - b. Stop the Data Integrator services.
  - c. Uninstall the Data Integrator Software.

For detailed instructions, see the section about preparing to install Data Integrator in the *Data Integrator Getting Started Guide*.
2. Install Java 1.5 Java Development Kit (JDK). Genesys Info Mart requires a version of Java 1.5 JDK that supports the 2007 changes to the U.S. daylight saving time. (Consult your Java vendor for details.) For more information, see the section about software requirements in the *Genesys Info Mart Deployment Guide*.
3. Install Data Integrator 11.0.2. For information about how to install Data Integrator, see the section about installing Data Integrator in the *Genesys Info Mart Deployment Guide*. When installing, note the following:
  - a. If you run Data Integrator Designer and the Data Integrator Job Server on different host systems, be sure to install Data Integrator 11.0.2 on both of them.
  - b. Make sure that you create a new local repository, using the database connection information for the new database schema that you created in [Step 2](#), on [page 840](#). Do not migrate the existing Data Integrator 6.5.1 local repository that you created for Genesys Info Mart 7.0.2.
  - c. You may wish to configure the Job Servers to use the same names and port numbers that were used by Data Integrator 6.5.1.
  - d. Make sure that you edit your Job Server configuration to add the new local repository and that you make it the default repository for that Job Server.
4. Edit Data Integrator's configuration file on the Job Server:
  - a. Set the `SkipValidationAtStartup` option to 1, in order to decrease the time it takes to load and optimize ETL jobs.
  - b. Set the `Global_DOP` option to the value appropriate for your job server hardware, in order to decrease the time that it takes to run ETL jobs.

- c. Set the `TREAT_CATCH_EXCEPTION_AS` option to `ERROR`, so that Data Integrator Web Administrator displays a red indicator beside a failed ETL job.
- d. In section `[AL_Engine]` set the `Enable_Statistics` option to `FALSE`, so that Data Integrator does not store execution metadata in the local repository database. Storing this metadata can cause ETL jobs to run significantly slower.

---

**Note:** For details about configuring these options, see the section about performance tuning in the *Genesys Info Mart Deployment Guide*.

---

5. On the Job Server:

- a. Install the appropriate JDBC driver for your RDBMS, which corresponds to the database type of the Interaction Concentrator, Staging Area, and Info Mart databases.

---

**Note:** Genesys Info Mart 7.2 uses JDBC drivers that are installed on the Job Server to communicate with the Interaction Concentrator, Staging Area, and Info Mart databases. See the section about JDBC drivers in the *Genesys Info Mart Deployment Guide*.

---

- b. Make the JDBC driver available for use by Genesys Info Mart.
6. If you are using Genesys Configuration Server release 7.2.000.06 (or later), and you intend to have Genesys Info Mart populate the membership of agents among skill expression-based virtual agent groups in its Resource Group Fact table:
- a. Perform the following in the 'hca' section of the Configuration Server application:
    - Set the `schema` option to `Journal`.
    - If the `record-vag` option is present, set it to `TRUE`.
  - b. Run the Configuration Server once with the `-hca` and `-u mm/dd/yyyy` command-line options to update the HCA tables with the current virtual agent group membership information.

Before the Configuration Server updates the configuration history tables, it prompts you with a message similar to the following:

```
Attention! You're about to initiate a task [Update] which
will change the content of the HCA tables. Press [Enter] to
proceed or [Ctrl+C] to cancel.
```

If you do not see this message, the Configuration Server's log-buffering option is set to `ON`, which prevents the message from being displayed. Press `[Enter]` to proceed or `[Ctrl+C]` to cancel.

---

**Note:** The objects added to the HCA tables by the `Update` command are populated in the configuration history as having been created on the date you specified with the `-u mm/dd/yyyy` option. You must choose a date that is earlier than the earliest interaction and resource record you will be extracting from all Call Concentrator, Interaction Concentrator, and Stat Server databases. The earliest date you can specify is January 5, 2000. Genesys Info Mart cannot transform and load data that occurred before that date.

---

**Warning!** It is very important that you update the HCA tables by using the `-u mm/dd/yyyy` Configuration Server command-line option, not the `-s mm/dd/yyyy` option. The `-s mm/dd/yyyy` option should never be used again once the HCA tables have been initially populated at deployment time.

---

7. Modify your Call Concentrator database(s) to enable Genesys Info Mart to extract a new attached data KVP that identifies Outbound Contact Server-related calls. See “Modifying Your Call Concentrator Database” on [page 848](#).

---

**Note:** You must perform this step, even if your contact center does not use Outbound Contact Solution.

---

8. If you are using Stat Server 7.1.000.10 (or later) and you intend to have Genesys Info Mart perform intraday loading, set the Stat Server `status-table-update-end-time-at-end-only` configuration option to `TRUE` in the `statserver` section of the Stat Server Application object.
9. If you are using Stat Server 7.2 you and intend to have Genesys Info Mart populate the Resource State Reason Fact table, set the Stat Server `voice-reasons-table` configuration option to `TRUE` in the `statserver` section of the Stat Server Application object.

---

**Note:** Do not set this option to `TRUE` while your Stat Server is running, unless you have already run the SQL script that creates the `VOICE_REASONS` table in the Stat Server database. See [Step 17](#) on [page 845](#).

---

10. If you have installed Interaction Concentrator and will be using Genesys Info Mart to populate Outbound Contact Solution data, see the section about the Interaction Concentrator database in the *Genesys Info Mart Deployment Guide* for information on configuring the Interaction Concentrator application to provide all the data needed by Genesys Info Mart.



In addition, if you intend to have Genesys Info Mart populate non-mandatory Outbound Contact Solution record fields in the Info Mart database, or if you intend to use the value of non-mandatory record fields to indicate Right Party Contacted or Conversion, you will need to perform configuration of the Field objects. For more information, see the section about configuring the mapping of OCS record fields in the *Genesys Info Mart Deployment Guide*.

11. Using Genesys Configuration Manager, update the configuration options and parameters in your Genesys Info Mart Application object. For a complete list of the new and changed configuration options, see “Configuration Option Changes from 7.0.2 to 7.2” on [page 786](#).
12. Configure the scheduling of the ETL jobs. In Genesys Info Mart 7.2, ETL job scheduling is now performed by the Genesys Info Mart Server component instead of the Data Integrator Web Administrator. Options in the new schedule section of the Genesys Info Mart application specify the scheduling used to launch the ETL jobs.  
  
See [Step 16](#) on [page 839](#), and the section about using Genesys Info Mart Server to launch ETL jobs in the *Genesys Info Mart Operations Guide*.
13. Create Data Access Points (DAPs) to access the Staging Area, Info Mart, and Interaction Concentrator databases. You will always need to create DAPs for the Staging Area and Info Mart databases. Create DAPs for any Interaction Concentrator database from which Genesys Info Mart will extract Outbound Contact Solution data. For information about configuring DAPs and DAP options, see the section about configuring Genesys Info Mart DAPs in the *Genesys Info Mart Deployment Guide*.  
  
Refer also to the database connection parameters needed to configure each DAP that you noted in the appropriate section of the Installation Checklist in the *Genesys Info Mart Deployment Guide*.
14. On each of the DAP Application objects that you created in [Step 13](#), add a connection to your Genesys Info Mart application. For more information, see the section about configuring the Genesys Info Mart application in the *Genesys Info Mart Deployment Guide*.
15. Uninstall the Genesys Info Mart 7.0.2 application:
  - a. On a Windows operating system: From the Windows Start menu, go to Settings >Control Panel > Add/Remove Programs.
  - b. On a UNIX operating system: When you run the new installation script, select the appropriate action (for example, Overwrite only the files contained in this package).
16. Install the Genesys Info Mart 7.2 application:
  - a. Run the installation program to copy files to the installation directory.
  - b. Run the Check Configuration program to validate your configuration option and DAP configuration values.
  - c. Import the ETL job metadata into the newly created local repository.



For more information, see the chapter about installing Genesys Info Mart in the *Genesys Info Mart Deployment Guide*.

17. Run the SQL script to update the Stat Server database schema:

---

**Note:** This script creates the VOICE\_REASONS table, which must now exist in order for JOB\_ExtractSS to run. You must run this SQL script, even if you do not intend to have Genesys Info Mart populate the Resource State Reason Fact table.

---

- a. Navigate to the Genesys Info Mart installation directory.
- b. Navigate to the sql\_scripts subdirectory.
- c. Navigate to the RDBMS-specific directory that corresponds to your Staging Area database type (db2, mssql, or oracle).
- d. Run:
  - voice\_reasons\_db2.sql (for db2)
  - voice\_reasons\_mssql.sql (for mssql)
  - voice\_reasons\_oracle.sql (for oracle)

---

**Notes:** The SQL scripts do not qualify database objects according to their schema or owner. When you run the SQL scripts, make sure that you use the ID of the schema or owner to log in to the database. You noted this information in the appropriate section of the Installation Checklist in the Genesys Info Mart Deployment Guide.

---

18. Run the SQL script to update the Staging Area database schema:

---

**Notes:** Make sure that you back up your 7.0.2 Staging Area database before you run the migration script. This can take a long time, depending on the amount of data in the database.

Also make sure that you turn on database session logging, so that if the script fails before it is finished, it will be easy for you to determine which statements completed successfully, and you can eliminate these from the script before you restart it.

---

- a. Navigate to the Genesys Info Mart installation directory.
- b. Navigate to the sql\_scripts subdirectory.
- c. Navigate to the RDBMS-specific directory for your Staging Area database type (db2, mssql, or oracle).
- d. Run migrate\_gim\_staging\_area.sql.

See the note about schemas and owners under [Step 17](#).

19. Run the SQL script to load the Staging Area database with metadata used by the jobs that perform aggregation (JOB\_LoadRecent and JOB\_AggregateGIM):

- a. Navigate to the Genesys Info Mart installation directory.

- b. Navigate to the `sql_scripts` subdirectory.
- c. Navigate to the RDBMS-specific directory for your Staging Area database type (`db2`, `mssql`, or `oracle`).
- d. Run `load_gim_staging_area.sql`.

See the note about schemas and owners under [Step 17](#).

20. Run the SQL script to update the Info Mart database schema:

---

**Notes:** Make sure that you back up your 7.0.2 Info Mart database before you run the migration script. This step may take a long time, depending on the amount of data in the database.

Also make sure that you turn on database session logging, so that if the script fails before it is finished, it will be easy for you to determine which statements completed successfully, and you can eliminate these from the script before you restart it.

- 
- a. Navigate to the Genesys Info Mart installation directory.
  - b. Navigate to the `sql_scripts` subdirectory.
  - c. Navigate to the RDBMS-specific directory for your Staging Area database type (`db2`, `mssql`, or `oracle`).
  - d. Run `migrate_gim.sql`.

---

**Notes:** The SQL script does not specify any particular logical or physical storage—for example, table spaces and partitions. Review and, if necessary, modify the SQL script to make sure that it is suitable for your deployment.

A column called `MEDIA_RESOURCE_KEY` was added to the `INTERACTION_FACT`, `INTERACTION_SEGMENT_FACT`, and `RESOURCE_SESSION_FACT` tables to represent the Extension or ACD Position associated with the fact. For existing facts in these tables, the migration script will populate the `MEDIA_RESOURCE_KEY` with a value representing the “Unknown” resource for the tenant since there is no way to determine the correct `MEDIA_RESOURCE_KEY` once the data has already been populated in the Info Mart database.

See also the note about schemas and owners under [Step 17](#) on [page 845](#).

---

21. Run the Genesys Info Mart 7.2 `make_gim_view.sql` and `make_gim_tenant_view.sql` scripts to re-create the read-only views and the tenant-specific read-only views on the Info Mart database. You will have to specify parameters for the owner ID and views owner ID, as you did when you created these views for Genesys Info Mart 7.0.2.

These SQL scripts are provided with Genesys Info Mart. For more information, see the chapter about Genesys Info Mart SQL scripts in the *Genesys Info Mart Deployment Guide*.

22. Re-create any custom database objects or permissions that become lost or invalidated during the update process. (You identified these objects and permissions in [Step 7 on page 840](#).)

23. Create Datastore Configurations for each of your datastores in the newly created local repository.

You noted the Datastore connection parameters needed to configure each Datastore Configuration in the appropriate section of the Installation Checklists in the *Genesys Info Mart Deployment Guide*.

For information about creating Datastore Configurations, see the section about Data Integrator databases and system configuration in the *Genesys Info Mart Operations Guide*.

24. Create System Configurations for the extraction, transformation, and loading (ETL) jobs in the newly created local repository. The ETL jobs that ship with Genesys Info Mart 7.2 differ from those in release 7.0.2.

To determine the System Configurations that you must create, review the information in the section about Data Integrator database and system configuration in the *Genesys Info Mart Operations Guide*.

For information about configuring the System Configurations, see the section about creating system configurations in the *Genesys Info Mart Operations Guide*. Pay particular attention to the names that must be used for the System Configurations, and their relationship to the option names for the Call Concentrator, Stat Server, and Interaction Concentrator databases that were specified in the Genesys Info Mart application configuration.

25. Log in to the Data Integrator Web Administrator, and add access to the newly created local repository that contains the Genesys Info Mart 7.2 ETL job metadata.

For information on adding connections to local repositories, see the section on connecting to the local repository in the *Genesys Info Mart Operations Guide*.

26. Run the Genesys Info Mart 7.2 ETL jobs one-by-one the first time, instead of scheduling them to run. For complete instructions, see the section on using the Web Administrator to run ETL jobs in the *Genesys Info Mart Operations Guide*.

---

**Note:** Make sure that you run `JOB_InitializeGIM` first. This job stores new fixed dimension information in the Staging Area and Info Mart databases.

---

27. After the successful initial run of the Genesys Info Mart 7.2 ETL jobs, enable the Genesys Info Mart Server to schedule the jobs. For more information, see the section about using Genesys Info Mart Server to launch ETL jobs in the *Genesys Info Mart Operations Guide*.

28. If you intend to use the Info Mart aggregate tables, and want to populate aggregates for your existing facts, make sure to run `JOB_AggregateGIM` and specify the aggregation time period. For more information, see the section about the `JOB_AggregateGIM` in the *Genesys Info Mart Operations Guide*.
29. When you are satisfied that Genesys Info Mart 7.2 is working properly, use your RDBMS database-specific tool to delete the Genesys Info Mart 7.0.2 local repository.

## Modifying Your Call Concentrator Database

Genesys Info Mart 7.2 functionality relies on a new key-value pair, `GSW_CALL_ATTEMPT_GUID`, attached by Outbound Contact Solution 7.2 (or your agent desktop application for Preview dialing campaigns). You must perform the steps in this section, even if your contact center does not use Outbound Contact Solution.

If any of the following is true for your deployment, perform the steps in [“Adding a Default Call Attempt GUID”](#) (below).

- Your contact center does not use Outbound Contact Solution.
- Your contact center uses Outbound Contact Solution; you want Genesys Info Mart to populate Outbound Contact Solution-related calls in the interaction fact tables, but you do not want to use Info Mart’s Interaction Type dimension to distinguish them from normal outbound calls.

If your contact center uses Outbound Contact Solution 7.2 and any of the following is true for your deployment, perform the steps in [“Adding Call Attempt GUID to Call Concentrator”](#) on [page 849](#).

- You want Genesys Info Mart to populate Outbound Contact Solution data (extracted from Interaction Concentrator), including contact attempt facts.
- You want Genesys Info Mart to populate Outbound Contact Solution-related calls (extracted from Call Concentrator) in the interaction fact tables, and you want to use Info Mart’s Interaction Type dimension to distinguish them from normal outbound calls.
- You want to prevent Genesys Info Mart from loading Outbound Contact Solution-related calls (extracted from Call Concentrator) in the interaction fact tables because of data quality issues that exist for ASM mode and switch-dialer based campaigns.

### Adding a Default Call Attempt GUID

If your Call Concentrator does not store `GSW_CALL_ATTEMPT_GUID` in its `EVREFEX` table, you must provide a default `NULL` Call Attempt GUID (global unique identifier) for Genesys Info Mart to extract.

---

**Notes:** Make sure that you repeat the step in this section for all your other Call Concentrator databases.

Genesys recommends that you make the change described in this section to the copy of `make_evrefex_view.sql` you ran when you installed Genesys Info Mart 7.0.2 so that the SQL script is consistent with your Call Concentrator database.

---

If your Call Concentrator database uses Oracle or Microsoft SQL Server, use your RDBMS tools to add the following mapping to the end of `EVREFEX_VIEW`: `NULL as GSW_CALL_ATTEMPT_GUID`

If your Call Concentrator database uses DB2, use your RDBMS tools to add the following mapping to the end of `EVREFEX_VIEW`:  
`CAST(NULL AS VARCHAR(64)) AS GSW_CALL_ATTEMPT_GUID`

## Adding Call Attempt GUID to Call Concentrator

To store the Call Attempt GUID in Call Concentrator's database, perform the steps in this section.

---

**Note:** Make sure that you repeat the steps in this section for all your Call Concentrator applications and databases.

Genesys recommends that you make the changes described in this section to the copy of `make_cdr_primary_keys.sql` and the copy of `make_evrefex_view.sql` so that the SQL scripts are consistent with your Call Concentrator database. You ran these scripts initially when you installed Genesys Info Mart 7.0.2.

---

1. Configure Call Concentrator to store the Call Attempt GUID. Using Configuration Manager, add the following to the `EventData` configuration option on your Call Concentrator Application object:

```
, char, GSW_CALL_ATTEMPT_GUID
```

If your Call Concentrator configuration has more than one `EventData` option, add it to the one that contains the mappings for the columns that are stored at the end of the `EVREFEX` row.

2. Add the Call Attempt GUID to Call Concentrator's `EVREFEX_TABLE`. If your Call Concentrator database uses Oracle, use your RDBMS tools to add the following column to the end of the table named `EVREFEX_TABLE`:

```
GSW_CALL_ATTEMPT_GUID VARCHAR2(64)
```

If your Call Concentrator database uses MS SQL Server or DB2, use your RDBMS tools to add the following to the end of the table named `EVREFEX_TABLE`:

```
GSW_CALL_ATTEMPT_GUID VARCHAR(64)
```

3. Add the Call Attempt GUID to the trigger `TIB_EVREFEX_TABLE`, defined on `EVREFEX_TABLE`, if your Call Concentrator database uses MS SQL Server. Use your RDBMS tools to add `GSW_CALL_ATTEMPT_GUID` to the end of the list of columns in both the `insert into EVREFEX_TABLE` and `select from inserted` statements in the trigger:

---

**Note:** Make sure that `GSW_CALL_ATTEMPT_GUID` appears in the same order in the column list for both statements in the trigger.

---

4. Add the Call Attempt GUID to Call Concentrator's `EVREFEX` insertion view. Use your RDBMS tools to add `GSW_CALL_ATTEMPT_GUID` to the end of the list of columns selected in the view named `EVREFEX`.
5. Add the Call Attempt GUID to Call Concentrator's `EVREFEX_VIEW` extraction view. Use your RDBMS tools to add the following column to the end of the list of columns selected in the view named `EVREFEX_VIEW`:  
`GSW_CALL_ATTEMPT_GUID as GSW_CALL_ATTEMPT_GUID`.

## Configuration Changes

To configure Genesys Info Mart 7.2, do the following:

1. Add new mandatory sections and options to the Genesys Info Mart application configuration.  
Refer to the “Configuration Option Changes in Genesys Info Mart 7.2” on [page 786](#) and add any new sections or options, designated in the table with a change type of "Section Added" or "Option Added". For information about configuring options, see the section about customizing your configuration in the *Genesys Info Mart Deployment Guide*.
2. Verify that the option names in the `ccon-data-sources` and `stat-server-data-sources` sections match the name of your system configurations.  
“Configuration Option Changes in Genesys Info Mart 7.2” on [page 786](#) of this document summarizes the changes to the Genesys Info Mart ETL application's configuration. For details about the configuring the new options, see the chapter about customizing your configuration in the *Genesys Info Mart Deployment Guide*.

## Verifying Option Dependencies

In order for the Genesys Info Mart Server to properly launch the `JOB_ExtractCCON` and `JOB_ExtractSS` ETL jobs, do the following:

1. Verify that each option name in the `ccon-data-sources` section matches the Data Integrator system configuration name that will be used when `JOB_ExtractCCON` is run against that data source. Either the option name or the system configuration name can be changed to ensure compliance with this dependency.

2. Verify that each option name in the `stat-server-data-sources` section matches the Data Integrator system configuration name that will be used when `JOB_ExtractSS` is run against that data source. Either the option name or the system configuration name can be changed to ensure compliance with this dependency.

For more information, see the section about Data Integrator datastore and system configuration in the *Genesys Info Mart Operations Guide*.

---

## Migrating Genesys Info Mart from 7.0.1 to 7.0.2

This section describes the steps that are required to migrate Genesys Info Mart and its supporting software from release 7.0.1 to release 7.0.2.

---

**Note:** Review all the steps before performing any of them. Make sure that you have the following resources available before you begin:

- *Genesys Info Mart 7.0.2 Deployment Guide*.
  - *Genesys Info Mart 7.0.2 Operations Guide*.
  - Business Objects Data Integrator 6.5.1 technical manuals. (You will install a new version of Data Integrator for Genesys Info Mart 7.0.2.)
  - *Genesys 7 Hardware Sizing Guide*—This document has been updated with the database size estimates for Genesys Info Mart 7.0.2.
  - Genesys Info Mart installation checklists that you completed when you installed Genesys Info Mart 7.0.1. These checklists, which you printed from the *Genesys Info Mart Deployment Guide*, contain database connection information you will need in order to reconfigure the datastore and system profiles for your environment. Remember to update the checklists if you make any changes for release 7.0.2.
- 

### Migration Planning

1. Consider updating Call Concentrator(s) to the latest Genesys 7 maintenance release. Although this is an optional task, upgrading to the latest maintenance release will generally allow Info Mart to produce higher-quality data.
2. Consider updating Stat Server(s) to the latest Genesys 7 maintenance release. Although this is an optional task, upgrading to the latest maintenance release will generally allow Info Mart to produce higher-quality data.



3. Review the list of new features in Genesys Info Mart 7.0.2 (see “Content Changes in Genesys Info Mart 7.0.2” on [page 774](#)), and determine which features you want to implement.
4. Review the Staging Area database’s data-size estimates in the *Genesys 7 Hardware Sizing Guide* for Genesys Info Mart 7.0.2. The 7.0.2 release stores more data than the 7.0.1 release; therefore, if necessary, allocate more physical database storage.
5. Review the data-size estimates for the Info Mart 7.0.2 database in the *Genesys 7 Hardware Sizing Guide*. The 7.0.2 release stores more data than the 7.0.1 release; therefore, if necessary, allocate more physical database storage.
6. The extraction, transformation, and loading (ETL) jobs that ship with Genesys Info Mart 7.0.2 differ from those in release 7.0.1. To plan an ETL job schedule that is suitable for your environment, review the descriptions of the Genesys Info Mart 7.0.2 ETL jobs— and how to schedule them—in the section about data transformation in the *Genesys Info Mart Operations Guide*.
7. Plan a time when you can complete the update. Several steps can take a significant amount of time to complete, which might affect the availability of Info Mart data.

## Pre-Migration Procedure

1. Allow the Genesys Info Mart 7.0.1 ETL jobs to finish their final extract, transform, and load. When the transform and load jobs have finished, do not allow another extract to run. Extracted data in the Staging Area database that has not been transformed and loaded into the Info Mart database will be lost when you install Genesys Info Mart 7.0.2. Use the Data Integrator Web Administrator to deactivate the ETL job schedules, so that the 7.0.1 ETL jobs do not run again. To deactivate the schedules:
  - a. Log in to the Data Integrator Web Administrator.
  - b. In the navigation tree, click Batch to display the list of Data Integrator local repositories.
  - c. In the navigation tree, click the local repository name to display the ETL job status.
  - d. Click the `Configuration` tab.
  - e. For each job, click `Schedules`, select the `Select All` check box to select all schedules, and click the `Deactivate` button to deactivate the selected schedules.

For more information, refer to the section about scheduling jobs in the *Data Integrator Administrator Guide*.



2. Create a new database schema for the Data Integrator 6.5.1 local repository. This repository will store the Genesys Info Mart 7.0.2 ETL job metadata. For information about how to create this database, see the section about installing Data Integrator in the *Genesys Info Mart Deployment Guide*.
- Back Up 7.0.1 Local Repository**
3. Back up your Genesys Info Mart 7.0.1 Local Repository database.
- Back Up 7.0.1 Staging Area Database**
4. Back up your Genesys Info Mart 7.0.1 Staging Area database. This can take a significant amount of time, depending on the amount of data that has accumulated in the Staging Area database.
- Back Up 7.0.1 Info Mart Database**
5. Back up your Genesys Info Mart 7.0.1 Info Mart database. This can take a significant amount of time, depending on the amount of data that has accumulated in the Info Mart database.
- Back Up 7.0.1 SQL Scripts**
6. Create backup copies of the Genesys Info Mart 7.0.1 deployment SQL scripts that you modified and ran when you deployed Genesys Info Mart 7.0.1. These SQL scripts perform the following tasks:
    - Create or modify source Call Concentrator and Stat Server databases.
    - Create the Call Concentrator EVREFEX extraction view.
    - Create the target Staging Area and Info Mart databases.
    - Create the Info Mart read-only views.

The Genesys Info Mart 7.0.2 installation program overwrites these SQL scripts, and it does *not* preserve your modifications.

To locate these SQL scripts, navigate to the Genesys Info Mart installation directory, and to its `sql_scripts` subdirectory. The SQL scripts are in the RDBMS-specific subdirectories (`db2`, `mssql`, and `oracle`).
  7. Identify any custom changes that you made to the Staging Area and Info Mart databases—for example, additional indexes, views, or permissions. This includes the permissions or privileges that you granted to the users of the Staging Area and Info Mart databases, as described in the section about database privileges in the *Genesys Info Mart Deployment Guide*.
 

The Genesys Info Mart SQL scripts that you will run to update these databases sometimes create new tables, instead of updating the old tables. You will need to re-create any custom database objects or permissions that become lost or invalidated during the update process.
- Back Up Configuration Options**
8. Create a backup copy of your Genesys Info Mart application's configuration options:
    - a. Log in to Genesys Configuration Manager.
    - b. Click the Options tab of the Genesys Info Mart Application object.
    - c. Click Export to Configuration File.
    - d. Type a target file name, and then click Save.

## Migration Procedure

1. Install Data Integrator 6.5.1 over 6.5.0. For information about how to install Data Integrator, see the section on installing Data Integrator in the *Genesys Info Mart Deployment Guide*. When installing, note the following:
  - a. If you plan to run Data Integrator Designer and the Data Integrator Job Server on different host systems, be sure to update both of them to Data Integrator 6.5.1.
  - b. Make sure that you create a new local repository, using the database connection information for the new database schema that you created in [Step 2](#) on [page 853](#). Do *not* migrate the existing Data Integrator 6.5.0 local repository that you created for Genesys Info Mart 7.0.1.
  - c. Configure a system locale for Data Integrator, as you did in Genesys Info Mart 7.0.1. This system locale, which is used by the Designer and Job Server, defaults to the locale set for the operating system. For more information on locales, see the section on locales and multi-byte functionality in the *Data Integrator Reference Guide*.

---

**Note:** Data Integrator might not prompt you for the system locale information, since you already specified the locale when you installed Data Integrator 6.5.0 for Genesys Info Mart 7.0.1.

---

- d. Make sure that you edit your Job Server configuration to add the new local repository and to make it the default repository for that Job Server.
2. Edit Data Integrator's configuration file on the Job Server:
    - Set the `SkipValidationAtStartup` option to 1, in order to decrease the time it takes to load and optimize ETL jobs.
    - Set the `Global_DOP` option to the value appropriate for your job server hardware, in order to decrease the time that it takes to run ETL jobs.

---

**Note:** For details about configuring these options, see the section about Data Integrator performance tuning in the *Genesys Info Mart Deployment Guide*.

---

3. Using Genesys Configuration Manager, update the configuration options and parameters in your Genesys Info Mart Application object.  
For a complete list of the new and changed configuration options, see "Configuration Option Changes from 7.0.1 and 7.0.2" on [page 791](#). Some options have been moved to allow tenants to better manage their own configuration options. These options are applicable to both single- and multi-tenant deployments.

4. Uninstall the Genesys Info Mart 7.0.1 application:
  - On a Windows operating system: From the Windows Start menu, go to Settings > Control Panel > Add/Remove Programs.
  - On a UNIX operating system: When you run the new installation script, select the appropriate action (for example, Overwrite only the files contained in this package).
5. Install the Genesys Info Mart 7.0.2 application:
  - a. Run the installation program to copy files to the installation directory.
  - b. Run the Check Configuration program to validate your configuration option values.
  - c. Import the ETL job, and localization metadata in to the newly created local repository.

Follow the instructions in the chapter about installing Genesys Info Mart in the *Genesys Info Mart Deployment Guide*.

6. Run the SQL script to update the Staging Area database schema:
  - a. Navigate to the Genesys Info Mart installation directory.
  - b. Navigate to the sql\_scripts subdirectory.
  - c. Navigate to the RDBMS-specific directory for your Staging Area database type (db2, mssql, or oracle).
  - d. Run migrate\_gim\_staging\_area.sql.

---

**Note:** The SQL scripts do not qualify database objects according to their schema or owner. When you run the SQL scripts, make sure that you use the ID of the schema or owner to log in to the database. You noted this information in the appropriate section of the installation checklist in the *Genesys Info Mart Deployment Guide*.

---

7. Run the SQL script to update the Info Mart database schema:

---

**Note:** This can take a long time, depending on the amount of data in the database.

---

- a. Navigate to the Genesys Info Mart installation directory.
- b. Navigate to the sql\_scripts subdirectory.
- c. Navigate to the RDBMS-specific directory for your Info Mart database type (db2, mssql, or oracle).
- d. Run migrate\_gim.sql.

---

**Note:** The SQL script does not specify any particular logical or physical storage. Review and, if necessary, modify the SQL script to make sure that it is suitable for your deployment.

See the note about schemas and owners under [Step 6](#).

---

8. Run the `make_gim_view.sql` and `make_gim_tenant_view.sql` scripts to re-create the read-only views and the tenant-specific read-only views on the Info Mart database.

These SQL scripts are provided with Genesys Info Mart. For more information, see the section about Genesys Info Mart SQL scripts in the *Genesys Info Mart Deployment Guide*.

9. Re-create any custom database objects or permissions that become lost or invalidated during the migration process. (You identified these objects and permissions in [Step 7](#) on [page 853](#).)

10. If necessary, customize the Datastore locales in the newly created local repository.

Genesys Info Mart ships Datastore objects with a default locale containing `language = English` and `code page = ms1252`. For more information, see the section about customizing your datastores in the *Genesys Info Mart Operations Guide*.

11. Create Datastore Profiles for each of your datastores in the newly created local repository, as you did in Genesys Info Mart 7.0.1.

You noted the Datastore connection parameters needed to configure each Datastore profile in the appropriate section of the installation checklist in the *Genesys Info Mart Deployment Guide*.

For more information about configuring Datastore Profiles, see the section about creating profiles in the *Genesys Info Mart Operations Guide*.

12. Create system profiles for the ETL jobs in the newly created local repository.

Genesys Info Mart 7.0.2 ships with different ETL jobs than those provided with release 7.0.1.

For information about creating and configuring system profiles, see the section about creating profiles in the *Genesys Info Mart Operations Guide*.

13. Log in to the Data Integrator Web Administrator and add access to the newly created local repository that contains the Genesys Info Mart 7.0.2 ETL job metadata.

For information on adding connections to local repositories, see the section about connecting to the local repository in the *Genesys Info Mart Operations Guide*.

14. Create and activate schedules for each ETL job in the newly created local repository.

You planned these schedules in “Migration Planning” on [page 851](#), [Step 6](#). For more information on job scheduling, see the section about job scheduling in the *Genesys Info Mart Operations Guide*.

15. After you have successfully run the Genesys Info Mart 7.0.2 ETL jobs, and when you are satisfied that Genesys Info Mart 7.0.2 is working properly, perform the following steps to clean up the Genesys Info Mart 7.0.1 ETL jobs and their local repository:
  - a. Log in to the Data Integrator Web Administrator.
  - b. Click **Batch** in the navigation tree, and then click the name of the old local repository that contains the Genesys Info Mart 7.0.1 ETL job metadata.
  - c. Click the **Configuration** tab.
  - d. For each job, click **Schedules**, select the **Select All** check box, and then click **Remove**.
  - e. Click **Management > Repositories** in the navigation tree.
  - f. Select the check box next to the old local repository name.
  - g. Click **Remove**.
  - h. Use the database tools for your RDBMS to delete the old local repository.

## Configuration Changes

To configure Genesys Info Mart 7.0.2, you must make the following configuration changes:

1. Adjust for tenant-specific configuration options that have been reorganized to allow tenants to independently access their own configuration.

For single-tenant deployments, configure option values for the default (Resources) tenant.

For multi-tenant deployments, configure default option values that apply to all tenants who do not need tenant-specific option values. Tenants who do not want to use these default option values can configure tenant-specific option values in the tenant's Annex tab.

2. Remove any obsolete options.
3. Configure new options that control Info Mart database purging and the amount of data transformed by a single run of the ETL jobs.

Table 141 on [page 791](#) summarizes the changes to the Genesys Info Mart ETL application's configuration. The sections that follow contain procedures for migrating your existing configuration ([Step 1](#) and [Step 2](#) above). For more information about configuring new options, see the section about customizing your configuration in the *Genesys Info Mart Deployment Guide*.

## Migrating Single-Tenant Deployments

The following procedure explains how to reorganize the tenant-specific portions of your Genesys Info Mart ETL application configuration, and how to delete options that are no longer used.

Perform the following migration steps within each Genesys Info Mart ETL application:

1. Delete the tenant option from the tenant-fiscal-periods section.
2. Add a new option named std-enterprise-time-zone to the gim-etl section.
3. Set std-enterprise-time-zone to the value configured for the Enterprise option in the standard-time-zones section.
4. Create a new section named gim-etl-tenant.
5. In the gim-etl-tenant section, add a new option named std-tenant-time-zone.
6. Set std-tenant-time-zone to the value configured for the default (Resources) tenant option in the standard-time-zones section.
- Days to Keep Info Mart Facts (Purging)** 7. In the gim-etl-tenant section, add a new option named days-to-keep-gim-facts.
8. Set days-to-keep-gim-facts to the value configured for the default (Resources) tenant in the days-to-keep-gim-facts section.
- Cleaning Up Old Options** 9. Delete the end-of-reporting-day option from the gim-etl section.
10. Delete the standard-time-zones section.
11. Delete the days-to-keep-gim-facts section.
- Saving Changes** 12. Click OK to save your changes.

## Migrating Multi-Tenant Deployments

The following procedures explain how to reorganize the tenant-specific portions of your Genesys Info Mart application configuration, and how to delete options that are no longer used.

Perform the following migration steps within each Genesys Info Mart ETL application:

- Tenant Fiscal Periods** 1. Delete the tenant option from the tenant-fiscal-periods section.
2. Set the remaining options in the tenant-fiscal-periods section to the default values that you want to apply to all tenants that do not need tenant-specific option values.
- Standard Time Zones** 3. Add a new option named std-enterprise-time-zone to the gim-etl section.
4. Set std-enterprise-time-zone to the value configured for the Enterprise option in the standard-time-zones section.

5. Create a new section named `gim-etl-tenant`.
  6. In the `gim-etl-tenant` section, add a new option named `std-tenant-time-zone`.
  7. Set `std-tenant-time-zone` to the default value that you want to apply to all tenants that do not need a tenant-specific option value.
- Days to Keep Info Mart Facts (Purging)**
8. In the `gim-etl-tenant` section, add a new option named `days-to-keep-gim-facts`.
  9. Set `days-to-keep-gim-facts` to the default value that you want to apply to all tenants that do not need a tenant-specific option value.
  10. Click OK to save your changes.
- Tenant-Specific Configuration**
11. If any of your tenants require tenant-specific option values for their fiscal periods, standard time zone, or days to keep Info Mart facts, see “Configuring the Tenant Annex Tab” on [page 859](#).

### Cleaning Up Old Options

After you have performed the above migration steps to migrate the configuration of all your Genesys Info Mart ETL applications, perform the following steps within each Genesys Info Mart ETL application to clean up old options:

1. Delete the `end-of-reporting-day` option from the `gim-etl` section.
2. Delete the non-default `tenant-fiscal-periods` sections. These sections each have a suffix, such as `tenant-fiscal-periods-2`. Do *not* delete the `tenant-fiscal-periods` section that you changed in [Step 1](#) on [page 860](#)—this section provides the default values for all tenants that do not require tenant-specific option values.
3. Delete the `standard-time-zones` section.
4. Delete the `days-to-keep-gim-facts` section.
5. Click OK to save your changes.

### Configuring the Tenant Annex Tab

The following procedure explains how to configure tenant-specific (non-default) option values for these portions of your Genesys Info Mart application configuration:

- Tenant fiscal periods
- Standard time zones
- Days to keep Info Mart facts (purging)

#### Displaying the Tenant Annex Tab

By default, Configuration Manager does not display the tenant’s Annex tab. To display the Annex tab:

1. Select `View > Options`.

2. Select the check box: Show Annex tab in object properties.
3. Click OK.

Perform the following steps within the tenant's Annex tab for each tenant that requires tenant-specific (non-default) option values:

#### Tenant Fiscal Periods

1. Create a new section named `gim-tenant-fiscal-periods`.

---

**Note:** If you already created a `gim-tenant-fiscal-periods` section for another Genesys Info Mart ETL application, add a suffix to the new section's name (for example, `gim-tenant-fiscal-periods-2`).

---

2. In the `gim-tenant-fiscal-periods` section, add a new option named `gim-etl-name`. Set `gim-etl-name` to the value of the Genesys Info Mart ETL application name.
3. Copy the following options from the appropriate Genesys Info Mart application's corresponding `tenant-fiscal-periods` section to the new `gim-tenant-fiscal-periods` section:
  - `last-month-of-year`
  - `last-day-of-last-month`
  - `first-day-of-week`
  - `last-day-identifies-year`
  - `week-pattern-in-quarter`

#### Standard Time Zones

4. Create a new section named `gim-etl-tenant`.

---

**Note:** If you already created a `gim-etl-tenant` section for another Genesys Info Mart ETL application, create the new section with a suffix (for example, `gim-etl-tenant-2`).

---

5. In the new `gim-etl-tenant` section, add a new option named `gim-etl-name`.
6. Set `gim-etl-name` to the value of the Genesys Info Mart ETL application name.
7. In the `gim-etl-tenant` section, add a new option named `std-tenant-time-zone`.
8. Set `std-tenant-time-zone` to the corresponding, tenant-specific value from the appropriate Genesys Info Mart application's `standard-time-zones` section.

#### Days to Keep Info Mart Facts (Purging)

9. Perform [Step 4](#) in this procedure (to create the `gim-etl-tenant` section), if you have not already done so.
10. In the `gim-etl-tenant` section, add a new option named `days-to-keep-gim-facts`.



11. Set `days-to-keep-gim-facts` to the corresponding, tenant-specific value from the appropriate Genesys Info Mart application's `days-to-keep-gim-facts` section.

**Saving Changes** 12. Click OK to save your changes.





## Part

# 16

## Expert Contact Migration

The chapters in this section show the migration process from release 6.5 to release 7.2 of Genesys Expert Contact. They also discuss component changes and the other Genesys software that supports and enables Genesys Expert Contact 7.2 functionality.

This Part contains the following chapters:

- Chapter 49, “Introduction to Genesys Expert Contact Migration,” on page 865 discusses the preliminary migration procedures, component compatibility, and changes for Genesys Expert Contact 7.2.
- Chapter 50, “Genesys Expert Contact Migration Procedures,” on page 875 discusses the migration procedures for releases 6.5 to 7.2.





## Chapter

# 49

## Introduction to Genesys Expert Contact Migration

This chapter discusses the preliminary migration procedures, component compatibility, and changes for Genesys Expert Contact 7.2. You can find basic information about Genesys Expert Contact in the *Genesys Expert Contact 7.2 Deployment Guide*. This chapter contains the following sections:

- [Preliminary Migration Procedures, page 865](#)
- [Migration Considerations, page 866](#)
- [Migration and Upgrade Order, page 868](#)
- [Interoperability Among Genesys Expert Contact Components, page 869](#)
- [Changes in Genesys Expert Contact, page 871](#)

---

## Preliminary Migration Procedures

Follow these procedures before migrating to Genesys Expert Contact 7.2.

---

**Note:** If you want to upgrade your operating system, do so before migrating your Genesys product.

---

## Preliminary Genesys Migration Procedures

The Genesys migration process includes these preliminary procedures for Genesys Expert Contact 7.2:

1. Review Chapter 1, “Migration Roadmap,” on [page 35](#) of this guide.
2. Examine the order in which the Genesys software required for Genesys Expert Contact 7.2 should be upgraded in Chapter 3, Introduction to Framework Migration. Then, see “Migration and Upgrade Order” on [page 868](#).

3. Examine the product, component, and option changes in “Changes in Genesys Expert Contact” on [page 871](#).

---

**Note:** Please note that these tables only discuss changes that directly affect the migration of this product. For more high-level information about what’s new in this release of Genesys Expert Contact 7.2 and how the 7.2 version functions, see the *Genesys Expert Contact 7.2 Deployment Guide*. For a complete list of documentation relevant to the migration of this product, see “Reference Materials”.

---

4. Review the licensing requirements for Genesys Expert Contact 7.2. See Chapter 2, “Licensing Migration,” on [page 41](#).
5. Check the interoperability of the components of Genesys Expert Contact 7.2 during the upgrade procedures. See “Interoperability Among Genesys Expert Contact Components” on [page 869](#).
6. See the *Genesys 7 Interoperability Guide* and the *Genesys 8 Interoperability Guide* for information on the compatibility of Genesys products with various Configuration Layer Environments; Interoperability of Reporting Templates and Solutions; and *Gplus* Adapters Interoperability.

## Reference Materials

- *Genesys Expert Contact 7.2 Deployment Guide*
- *Genesys Licensing Guide*
- *Genesys 7 Interoperability Guide*
- *Genesys 8 Interoperability Guide*

---

## Migration Considerations

Migration paths depend on the version of the CTI-Less T-Server that you are migrating. In all cases it is assumed you are migrating to the most recent version.

### Single Site, Multi-Site, and Multi-Tenant Migration

It is possible to migrate all sites or all tenants simultaneously. It is also possible to migrate separate sites independently. There can also be interoperability of different versions at different sites.

#### Single-Site Migration

- In single-site migrations, you need to suspend work in your production environment during the T-Server migration process.

- Multi-Site Migration**
- In multi-site environments, while you are undergoing the migration process, you need to reroute work through another CTI-Less T-Server during upgrade in order to avoid suspending work.  
To minimize the amount of re-routing time, it is possible to do a partial upgrade and migrate only certain components during the re-route period.

## Redundant T-Servers

Since T-Servers can operate in a high-availability (HA) configuration, providing you with redundant systems, you may be migrating multiple servers. In the cases of both primary and backup T-Servers, the migration process is the same.

- High Availability** Redundant CTI-Less T-Servers: Since CTI-Less T-Servers can operate in a high-availability (HA) configuration, providing you with redundant systems, you may be migrating multiple servers. In the cases of both primary and backup T-Servers, the migration process is the same.

When running CTI-Less T-Servers in either Hot or Warm Standby mode, the primary and backup CTI-Less T-Server must also be the same major release (although within the major release there can be different software versions). Instructions for configuring T-Server in a redundant configuration are available in the *Genesys Expert Contact 7.2 Deployment Guide*.

- Rolling Upgrades** Release 7.2 supports rolling upgrades, which enables you to upgrade one CTI-Less T-Server at a time, alternating primary and backup servers during the maintenance phase. For example, you can upgrade one CTI-Less T-Server in a primary backup pair from the 7.0 release to the 7.2 release, while running the other 7.0 version as the primary. Then, you can upgrade the other CTI-Less T-Server.

## Expert Impact

During the CTI-Less T-Server migration, determine how you want to migrate the server to minimize impact on routing to experts associated with that server.

## Licensing

Regardless of which version of CTI-Less T-Server you have prior to migrating, be sure to check on the licensing requirements for the new version. In all cases, refer to the *Genesys Licensing Guide* available on the Technical Support Website for more information.

---

**Note:** In the Genesys Expert Contact 7.2, high availability configurations do not require duplicate licenses. The HA license for your CTI-Less T-Server applies to both the primary and backup T-Servers.

---

## Backward Compatible

CTI-Less T-Server 7.2 is fully backward compatible with the 7.0 and 6.5 releases of CTI-Less T-Server clients (for example, GCN Web). See “Interoperability Among Genesys Expert Contact Components” on [page 869](#).

## CTI-Less T-Server Enhancements

### Release 7.2

The following sections describe some of the major functional differences between the 7.2 and 7.0 releases of CTI-Less T-Server.

#### Unified Call-Party States

CTI-Less T-Server now supports unified call-party states. When a client application queries CTI-Less T-Server, CTI-Less T-Server returns the unified call-party state. This provides detailed information about the state of the call parties. For more information about call-party states, see the *T-Library SDK 7.2 C Developer’s Guide*.

### Release 7.0

The following sections describe some of the major functional differences between the 7.0 and 6.5 releases of CTI-Less T-Server.

#### Upgrade to Licensing Control

Licensing for CTI-Less T-Server is based on different criteria than it was for earlier releases. Be sure to refer to the *Genesys Licensing Guide* for complete licensing details. This guide also describes new licensing features that are available with this most recent release of CTI-Less T-Server.

#### Log Messages Improvement

CTI-Less T-Server provides more detailed message descriptions for log files and error messages, including more descriptions of possible workarounds and fixes.

#### Enhanced Support for User Data

The amount of user data that can be associated with an interaction is now configurable. The default setting is 16,000 bytes, but you can increase that value up to 65,535 bytes. This increased user-data limit gives you greater flexibility in customizing CTI-Less T-Server for your specific contact center environment. See *T-Library SDK 7.2 C Developer’s Guide*.

---

## Migration and Upgrade Order

Migrate or upgrade the application components of Genesys Expert Contact, the other enabling software, and relevant data in the following order:



---

**Note:** See procedures detailing this order in Chapter 50, “Genesys Expert Contact Migration Procedures,” on [page 875](#).

---

1. Install Licensing Manager.
2. See Chapter 2, “Licensing Migration,” on [page 41](#) and the *Genesys Licensing Guide*.
3. Migrate Management Framework.

---

**Note:** You can migrate to the 7.2 Configuration Layer while still using 7.1, 7.0, or 6.5 components. If you want to change DB before Configuration Layer migration, migrate the database, then the data, and run the Configuration Conversion Wizard (CCW).

---

Management Framework is the foundation for all Genesys products, solutions, and options.

For information about migrating the layers and components of Management Framework, see Chapter 2, “Migration Roadmap” on [page 35](#) of this guide.

4. Upgrade other prerequisite Genesys components.
5. When upgrading many components, determine if the first component you upgrade to version 7.2 is backward compatible with previous versions of the components that you have not yet upgraded. See “Interoperability Among Genesys Expert Contact Components” on [page 869](#).
6. If necessary, migrate data (for example, Solution specific data, Contact Center data, Reporting data), scripts, and routing strategies.
7. Migrate the agent desktop.

---

## Interoperability Among Genesys Expert Contact Components

The term *interoperable* refers to whether different versions of Genesys solutions, components, or options can work together compatibly during the migration process.

Interoperability of Genesys products can occur at two levels of migration:

- **Interoperability at the suite-level** means combining different versions of solutions and options during the migration process.

**Example:** You can migrate to the Configuration Layer of Framework 7.2, while still using CTI-Less T-Server 7.0 or 6.5. See the *Genesys 7 Interoperability Guide* and the *Genesys 8 Interoperability Guide* for information on the compatibility of Genesys products with various

Configuration Layer Environments; Interoperability of Reporting Templates and Solutions; and *Gplus* Adapters Interoperability.

- **Interoperability at the solution-specific level** means combining different versions of the components of a particular solution while upgrading them sequentially during the migration process.

The following section provides the details.

## CTI-Less T-Server Interoperability

### Hot or Warm Standby Mode

If you are running your CTI-Less T-Servers in a Hot or Warm Standby mode, then the primary and backup CTI-Less T-Servers must both be of the same release family (although within the family there can be minor-release differences).

### Multi-Site Environment

Multi-site deployments of T-Server allow for interoperability of T-Server versions between sites. You can migrate one T-Server without migrating your other T-Servers. Use this concept to keep your production system up during migration. You will need to route work through alternate T-Servers while migrating a given T-Server to the current release.

## Genesys Expert Contact Compatibility

[Table 146](#) shows compatibility with 6.x versions of Framework

**Table 146: CTI-Less T-Server Compatibility in Framework 6.x Environments**

|                       | 6.0 Framework | 6.1 Framework | 6.5 Framework |
|-----------------------|---------------|---------------|---------------|
| CTI-Less T-Server 7.0 | Not supported | Not supported | Supported     |
| CTI-Less T-Server 6.5 | Not supported | Not supported | Supported     |

[Table 147](#) shows compatibility with 7.x versions of Framework

**Table 147: CTI-Less T-Server Compatibility in Framework 7.x Environments**

|                       | 7.0 Framework | 7.1 Framework | 7.2 Framework |
|-----------------------|---------------|---------------|---------------|
| CTI-Less T-Server 7.0 | Supported     | Supported     | Supported     |
| CTI-Less T-Server 6.5 | Supported     | Supported     | Supported     |

Table 148 shows compatibility between desktop components and CTI-Less T-Server.

**Table 148: Desktop Component and CTI-Less T-Server Compatibility**

|                     | CTI-Less T-Server 6.5 | CTI-Less T-Server 7.0 | CTI-Less T-Server 7.2 |
|---------------------|-----------------------|-----------------------|-----------------------|
| GCN Web 6.5         | Supported             | Supported             | Supported             |
| Genesys Desktop 7.x | Supported             | Supported             | Supported             |

---

## Changes in Genesys Expert Contact

This section discusses product changes (additions, deletions, and modifications) that need to be specifically addressed during the migration process. See the *Genesys Expert Contact 7.2 Deployment Guide* for a comprehensive list of changes.

## Component Changes for Genesys Expert Contact 7.x

Table 149 shows addition and deletion component changes between Genesys Expert Contact 6.5 and 7.2.

**Table 149: Component Changes from 6.5 to 7.2**

| Current Component Name | Type of change                                                                          | Change Occurred in Version # | Details (optional)                                                                                                  |
|------------------------|-----------------------------------------------------------------------------------------|------------------------------|---------------------------------------------------------------------------------------------------------------------|
| CTI-Less T-Server      | Support for Hot standby<br>Does not support Solaris 2.6 or 2.7                          | 7.0                          |                                                                                                                     |
|                        | Now supports:<br>Red Hat Enterprise Linux<br>Solaris 32/64 bit version 10<br>Tru64 UNIX | 7.2                          | See the <i>Genesys Supported Operating Environment Reference Manual</i> for a complete list of supported platforms. |
| Genesys Desktop        | New component                                                                           | 7.0                          | This desktop application replaces GCN Web in this release. Genesys Desktop is also a web-based application.         |

## Configuration Option Changes for Expert Contact

Table 150 summarizes the changes to the options for Genesys Expert Contact between 6.5 and 7.0.

---

**Note:** There were no changes to configuration options between 7.0 and 7.2.

---

**Table 150: Configuration Option Changes from 6.5 to 7.0**

| Section Name                       | Option Name        | Type of Change    | Change Occurred in Version # | Details (optional)                                                                                                                 |
|------------------------------------|--------------------|-------------------|------------------------------|------------------------------------------------------------------------------------------------------------------------------------|
| <b>CTI-Less T-Server</b>           |                    |                   |                              |                                                                                                                                    |
| License                            | num-of-licenses    | New               | 7.0                          | Moved from the TServer section to the license section in release 7.0. See the <i>Genesys Expert Contact 7.2 Deployment Guide</i> . |
|                                    | num-sdn-licenses   | New               | 7.0                          | New in release 7.0. See the <i>Genesys Expert Contact 7.2 Deployment Guide</i> .                                                   |
| extrouter                          | cast-type          | New default value | 7.0                          | Default value is now direct-notoken, direct-ani                                                                                    |
| TServerSap                         | track-active calls | New               | 7.0                          | New in release 7.0. See the <i>Genesys Expert Contact 7.2 Deployment Guide</i> .                                                   |
| <b>Genesys Desktop<sup>a</sup></b> |                    |                   |                              |                                                                                                                                    |
| kworker                            | show-on-preview    | New               | 7.0                          | New in release 7.0. See the <i>Genesys Expert Contact 7.2 Deployment Guide</i> .                                                   |

a. All options specific to Genesys Expert Contact in GCN Web 6.5 are also in Genesys Desktop.





## Chapter

# 50

## Genesys Expert Contact Migration Procedures

This chapter discusses the migration procedures for releases 6.5 to 7.2 and contains the following sections:

- [CTI-Less T-Server Migration, page 875](#)
- [Deploying CTI-Less T-Server 7.2 in a 6.x Environment, page 878](#)
- [GCN Web and Genesys Desktop, page 879](#)

---

**Note:** Genesys Expert Contact was a new product as of the 6.5 release. There are no migration procedures previous to the 6.5 releases.

---

---

## CTI-Less T-Server Migration

This section describes how to migrate from a 6.5 or 7.0 to the 7.2 release of CTI-Less T-Server.

### Licensing

Prior to migrating your CTI-Less T-Server, be aware that you need to take licensing issues into account. Starting with release 7.0, CTI-Less T-Servers refer to the license server for authentication.

The new license server rules are described in the *Genesys Licensing Guide*. Also refer to the *Genesys Expert Contact 7.2 Deployment Guide* for licensing information.

---

**Note:** The licensing requirements for CTI-Less T-Server 7.x are different from those in the 6.5 release.

---

**Licensing Requirements for T-Server**

The following are short descriptions of the issues you must consider when deploying your new licensing for CTI-Less T-Server:

- A stand-alone CTI-Less T-Server serving a single site requires licenses to register all DNs it monitors.
- CTI-Less T-Servers operating with the hot standby redundancy require a special CTI HA technical license, which allows for high-availability implementations in addition to regular CTI-Less T-Server licenses.
- CTI-Less T-Servers performing multi-site operations require licenses that allow for such operations in addition to regular CTI-Less T-Server licenses.

**Licensing Prerequisites**

Before starting your migration of CTI-Less T-Server:

1. Obtain appropriate license files for 7.2 CTI-Less T-Servers.
2. Install Licensing Manager (if it is not already installed).

**Other Migration Information**

Related migration information that may help you migrate CTI-Less T-Server is available elsewhere in this guide. See:

1. Chapter 2, “Licensing Migration,” on [page 41](#)
2. *Genesys 7 Interoperability Guide*
3. *Genesys 8 Interoperability Guide*

## CTI-Less T-Server Migration Procedures

Use the following two sections to assist you in performing a basic upgrade to a 7.2 release or rollback to a previous release of CTI-Less T-Server.

---

**Note:** When upgrading an existing component, you are not creating a new component object but rather using the existing component object (with the original name) and configuring it with the options available as a result of the newly installed executable. Do not create a new Application object in Configuration Manager or rename the existing Application object.

---

### CTI-Less T-Server Upgrade Procedures

**To Upgrade T-Server**

Perform the following steps for each CTI-Less T-Server Application object:

1. In Configuration Manager, open the **Properties** dialog box for your existing CTI-Less T-Server Application object (whether release 6.5 or 7.0).
2. From the **Options** tab, export the existing configuration option settings in a \*.cfg file using the **Export** utility. Preserve this \*.cfg file in a secure location in case you need to rollback later or use it as a reference. Refer to *Framework 7.2 Configuration Manager Help* for instructions on using the **Export** utility.



3. Install the CTI-Less T-Server 7.2 application. For installation instructions, refer to the *Genesys Expert Contact 7.2 Deployment Guide*.  
This location should be the same location as your previous version.
4. Verify the parameters on the Start Info tab of the CTI-Less T-Server Application object in Configuration Manager—the CTI-Less T-Server working directory, executable name, and command-line parameters.
5. Specify any new configuration options on the Options tab of the CTI-Less T-Server Application object. See list Table 150 on [page 873](#) to see what options were changed or added between the 6.5 and 7.x releases. See the *Genesys Expert Contact 7.2 Deployment Guide* for complete details on options.
6. On the Connections tab, verify that the proper connections are still in place for CTI-Less T-Server. See the *Genesys Expert Contact 7.2 Deployment Guide* for information on connections.
7. If you have not previously used the centralized-logging and alarm-signaling capabilities of the Management Layer, but would like to do so now, add a connection to Message Server on the Connections tab of the CTI-Less T-Server Application object in Configuration Manager.

Refer to the “Starting and Stopping Procedures” chapter in the *Genesys Expert Contact 7.2 Deployment Guide* for startup instructions.

## CTI-Less T-Server Rollback Procedures

### To Rollback to Earlier Version

If you must return to your previous version of CTI-Less T-Server:

1. In Configuration Manager, display the Properties dialog box for the CTI-Less T-Server Application object.
2. On the Options tab, click the Import from Configurations File icon and locate the configuration file (\*.cfg file) you exported in Step 2 on [page 876](#) to restore the previously configured settings. Refer to *Framework 7.2 Configuration Manager Help* for instructions on using the Import utility.

---

**Note:** This procedure overwrites the options on this tab with those in the configuration file.

---

3. Delete any new connections to server applications you have configured on the Connections tab of the CTI-Less T-Server Application object in Configuration Manager.
4. Click OK to save the changes and close the dialog box.
5. Uninstall CTI-Less T-Server 7.2.

6. Install the previous version of CTI-Less T-Server.
7. Verify the parameters on the Start Info tab of the CTI-Less T-Server Application object in Configuration Manager—the CTI-Less T-Server working directory, executable name, and command-line parameters.

---

## Deploying CTI-Less T-Server 7.2 in a 6.x Environment

CTI-Less T-Server 7.2 supports deployment in an environment that will continue to use 7.1, 7.0, or 6.5 Genesys components. The steps required for this type of deployment are the same as those you must take to install CTI-Less T-Server in a 7.2 environment. The differences in the mixed environment case determine how you must deploy your licensing for T-Server.

---

**Note:** If you are running your CTI-Less T-Servers in either Hot or Warm Standby mode, then the primary and backup T-Servers must both be of the same release family (although within the family there can be different minor release differences).

---

### Licensing Issues for CTI-Less T-Server 7.2 in a 6.x Environment

While the steps for migrating a CTI-Less T-Server to a 7.2 or a mixed environment are generally the same, there are a few licensing issues that you need to consider for the mixed environment.

#### License Section in Options Tab

The license section in the Options tab of the CTI-Less T-Server Application object in Configuration Manager is not required for backward compatibility in the 6.x environment. However, in the event that you need to specify numbers of licenses, you may add that section. See the *Genesys Expert Contact 7.2 Deployment Guide* for more information on this section.

#### To Deploy Licensing for T-Server

There are two ways to deploy licensing for CTI-Less T-Server 7.2 in a 6.x environment:

1. Use one 8.3 License Manager (LM) for the whole environment  
**or**
2. Use two separate LMs—one for 6.x applications and another one for 7.2 applications. In this case, retain your existing 6.x license, and order the appropriate 7.2 licenses for their related servers.

---

**Note:** Genesys 5.x and 6.x applications require FLEXlm License Manager 6.1 or higher; Genesys 7.2 applications require FLEXlm License Manager 8.3 or higher; and only Genesys applications for Red Hat Linux Enterprise require FLEXlm License Manager 9.5.

---

If you choose option number 1 above (use one LM 8.3), select from either of the following lists of procedures, Procedures List 1 or Procedures List 2:

Procedures List 1

- a. Order CTI-Less T-Server 7.2 licenses for the same host where your LM is running.
- b. Update the license file with the new features for your new CTI-Less T-Server.
- c. Install LM 8.3. Configure it in the same way you configured your previous LM, using the same port and license file.
- d. Install 7.2 CTI-Less T-Server.
- e. Stop the old LM and start LM 8.3.
- f. Start CTI-Less T-Server.

Or:

Procedures List 2

- a. Order 7.2 CTI-Less T-Server licenses for any other hosts where your LM 8.3 will be running.
- b. Install LM 8.3.
- c. Run LM 8.3 with the new license file (containing licenses for CTI-Less T-Server 7.2).
- d. Install CTI-Less T-Server.
- e. Start CTI-Less T-Server.

If you use two or more CTI-Less T-Servers and these CTI-Less T-Servers share licenses, create a new section called `license` on the `Options` tab for each CTI-Less T-Server application in the Configuration Layer before you start the CTI-Less T-Servers. Configure the `license` section options before starting CTI-Less T-Server. See the *Genesys Licensing Guide* and *Genesys Expert Contact 7.2 Deployment Guide* for information on configuring license options.

---

**Note:** Since licensing is based on DNs in use, be sure to configure in the Configuration Database all DNs that experts use (ACD Positions and Extensions) and that CTI-Less T-Server should control.

---

---

## GCN Web and Genesys Desktop

If you want experts to use Genesys Desktop instead of GCN Web, do the following:

1. In Configuration Manager, open the `Properties` dialog box for the GCN Web 6.5 Application object.

2. From the `Options` tab, export the existing configuration option settings in a `*.cfg` file using the Export utility. Preserve this `*.cfg` file in a secure location in case you need to rollback later. Refer to *Framework 7.2 Configuration Manager Help* for instructions on using the Export utility.
3. Install the Genesys Desktop application. For installation instructions, refer to the *Genesys Desktop 7.2 Deployment Guide*, or a later version.
4. Open the `.cfg` file that you previously exported in a text editor and compare them with the list in Table 150 on [page 873](#) to see what options were changed or added between release 6.5 and 7.x.

---

**Note:** Genesys Desktop is based on GCN Web so many of the options will be the same.

---

5. Open the Genesys Desktop Application object and specify any new configuration options on the `Options` tab.  
See the *Genesys Expert Contact 7.2 Deployment Guide* for complete details on options.
6. Verify on the `Connections` tab that the proper connections are still in place for Genesys Desktop. See the *Genesys Expert Contact 7.2 Deployment Guide* for information on connections.
7. Click `OK` to save the changes and close the dialog box.



## Part

# 17

## Multimedia Migration

Multimedia was called Multi-Channel Routing (MCR) in releases 7.0 and 7.1. The chapters in this section show the migration process from release 7.0 to release 7.1 of MCR, from release 7.1 of MCR to release 7.2 of Multimedia, and from release 7.2 to 7.5, 7.5 to 7.6, and 7.6 to 8.0 for Multimedia. They also discuss component changes and the other Genesys software that supports and enables Genesys Multi-Channel Routing and Multimedia functionality.

This part contains the following chapters:

- [Migration Order for Multimedia, page 883](#) discusses preliminary migration procedures and migration order.
- [Changes in Components and Configuration Options, page 897](#) provides information that you need to upgrade components and configuration options.
- [Migration Procedures, page 911](#) describes detailed migration procedures.





## Chapter

# 51

## Migration Order for Multimedia

This chapter discusses the preliminary migration procedures and the migration order for Multi-Channel Routing 7.1, Multimedia 7.2, Multimedia 7.5, Multimedia 7.6.0, Multimedia 7.6.1, and Multimedia 8.0.

There are three main sections in this chapter:

- [Preliminary Migration Procedure, page 883](#)
- [Multi-Site and Multi-Tenant Migration, page 884](#)
- [Interoperability Among Multimedia Components, page 884](#)

---

### Preliminary Migration Procedure

This section provides information that you should be aware of before beginning migration.

For an overview of migration issues, see the chapter “Migration Roadmap” on [page 35](#) of this guide.

---

**Note:** If you want to upgrade your operating system before migrating your Genesys product, contact Professional Services.

---

The migration process includes these preliminary procedures for Multi-Channel Routing 7.1 and Multimedia 7.x and 8.x:

1. Review the chapter “Migration Roadmap” on [page 35](#) of this guide.
2. Examine the order in which the Genesys software that is required for Multi-Channel Routing or Multimedia should be upgraded. See “Migration Procedures” on [page 914](#).
3. Examine “Changes to Configuration Options” on [page 899](#).

4. Review the licensing requirements for Multi-Channel Routing or Multimedia. See the chapter “Licensing Migration” on [page 41](#) of this guide.
5. Check the interoperability of the components of Multi-Channel Routing or Multimedia during the upgrade procedures. See “Interoperability Among Multimedia Components” on [page 884](#).

See also the following reference materials:

- *Genesys Licensing Guide* for information on licensing.
- See the *Genesys 7 Interoperability Guide* and the *Genesys 8 Interoperability Guide* for information about interoperability.
- The following documents for the relevant versions of MCR or Multimedia:
  - Deployment Guide
  - User’s Guide
  - Reference Manual

---

## Multi-Site and Multi-Tenant Migration

Genesys recommends that you migrate all Multimedia sites and/or tenants at the same time. For any other scenario, you must contact Genesys Technical Support for assistance.

---

## Interoperability Among Multimedia Components

The term *interoperable* means that different versions of Genesys solutions, components, or options can work together compatibly during the migration process.

*Interoperability* of Genesys products can occur at two levels of migration:

- **Interoperability at the suite level** means combining different versions of solutions and options during the migration process.
- **Example:** You can migrate to the Configuration Management Layer of Framework 7.2 while still using 6.x or 7.0 components. See the *Genesys 7 Interoperability Guide* and the *Genesys 8 Interoperability Guide* for information about interoperability.
- **Interoperability at the solution-specific level** means combining different versions of the components of a particular solution while upgrading them sequentially during the migration process.

The mixture of components may include the executables, applications, routing strategies, scripts, and data that compose a particular solution.



As you upgrade each of the components in sequence, you will need to know if it is backward-compatible with the other components of Multimedia.

This section provides answers to this important question.

---

**Note:** In general, a new release of Genesys Framework preserves compatibility with the immediately preceding releases of Genesys solutions. However, DB Server 7.5 is not compatible with Interaction Server 7.2 (and earlier).

---

## Compatibility Between Multimedia/MCR and Genesys Framework

### Genesys 7.1 and MCR 7.1

Besides being compatible with all Genesys 7.1 components, MCR 7.1 is compatible with the following:

- Framework 7.0.1, with the following qualifications:
  - Genesys recommends Framework 7.1.1.
  - Interaction Server requires DB Server 7.0.100.03 or later.
- Management Layer 7.0.1.
- StatServer 7.0.2 (if you do not require any statistics to be collected using MCR Statistics Extensions 7.1).
- Universal Routing Server 7.0.1 (but objects that are new in Interaction Routing Designer 7.1 are not supported).

### Genesys 7.2 and Multimedia 7.2

Besides being compatible with all Genesys 7.2 components, Multimedia 7.2 is compatible with the following:

- Configuration Layer 7.1.

---

**Note:** You must add the Business Attribute `Outbound Notification` manually to the 7.1 Configuration Layer.

---

- DB Server 7.1
- Management Layer 7.1
- Universal Routing Server 7.1, except that objects that are new in Interaction Routing Designer 7.2 are not supported.
- Multimedia 7.2 is compatible with the following, as long as Interaction Server is of the old type `T-Server` rather than the new type `Interaction Server`:

- Universal Routing Server 7.1
- Interaction Routing Designer 7.1
- Genesys Desktop 7.1
- Multimedia is not compatible with Stat Server 7.1. It requires Stat Server 7.2.000.10 or higher.

## Genesys 7.5 and Multimedia 7.5

Besides being compatible with all Genesys 7.5 components, Multimedia 7.5 is compatible with all Genesys 7.2 components, with the following qualifications:

- Multimedia features that are new in 7.5 are not necessarily supported.
- Genesys recommends using Multimedia with Stat Server 7.5. Stat Server 7.2 returns an error if it receives the statistics types that are new in 7.5.
- DB Server 7.5 is strongly suggested.

## Genesys 7.6 and Multimedia 7.6.0

Besides being compatible with all Genesys 7.6 components, Multimedia 7.6.0 is compatible with all Genesys 7.5 components, except that Multimedia features that are new in 7.6.0 are not necessarily supported.

Interaction Server 7.6.0 is also compatible with Genesys Desktop 7.2 if the Interaction Server `ignore-read-only-on-change` option is set to `true`.

## Genesys 7.6 and Multimedia 7.6.1

Besides being compatible with all Genesys 7.6.1 components, Multimedia 7.6.1 is compatible with all Genesys 7.6.0 components, except that Multimedia features that are new in 7.6.1 are not necessarily supported.

## Genesys 8.0 and Multimedia 8.0

At the time of the 8.0 release of Multimedia, many other Genesys 8.0 components had not been released. Information about compatibility between 8.0 Genesys products and Multimedia 8.0 is announced with the release of each product that is related to Multimedia.

Multimedia 8.0 is compatible with all Genesys 7.6 components, except that Multimedia features that are new in Multimedia 8.0 are not necessarily supported.

## Compatibility Among Components of Multimedia

### MCR 7.1 with MCR 7.0

Table 151 lists compatibility between 7.1 and 7.0.1 MCR components.

**Table 151: Compatibility of MCR 7.1 with MCR 7.0.1**

| Component                        | Compatible with MCR 7.0.1?            |
|----------------------------------|---------------------------------------|
| Chat Server                      | Yes                                   |
| Classification Server            | Yes, except requires UCS 7.1          |
| E-mail Server Java               | Yes, except requires UCS 7.1          |
| Interaction Server               | Yes (requires upgrading the database) |
| Interaction Workflow Samples     | No                                    |
| Knowledge Manager                | No                                    |
| Third Party Components           | No <sup>a</sup>                       |
| Training Server                  | Yes, except requires UCS 7.1          |
| Universal Contact Server         | Yes (requires upgrading the database) |
| Universal Contact Server Manager | Yes                                   |
| Web API Server                   | Yes                                   |
| Web Compound Samples             | Yes <sup>b</sup>                      |

- a. Third Party Components 7.1 and 7.0.1 can coexist. You should install the web part of this component only if you intend to upgrade your web components. To avoid installing the web part, select `Other` when the installation asks you to select a servlet engine.
- b. Web Compound Samples includes samples of functionalities that are new in 7.1. These new samples are not compatible with MCR 7.0.1.

### Multimedia 7.2 with MCR 7.1

---

**Note:** You cannot install any Multimedia 7.2 component in the same directory as an MCR 7.1 component. For a mixed solution, Multimedia 7.2 components and MCR 7.1 components must be in separate directories.

---

Table 152 lists compatibility between Multimedia 7.2 and MCR 7.1 components.

**Table 152: Compatibility of Multimedia 7.2 with MCR 7.1**

| Component                    | Compatible                                                                                                                                                                                                                                                                                                                                                                                                         |
|------------------------------|--------------------------------------------------------------------------------------------------------------------------------------------------------------------------------------------------------------------------------------------------------------------------------------------------------------------------------------------------------------------------------------------------------------------|
| Chat Server                  | Yes. However: <ul style="list-style-type: none"> <li>For Chat Server to work correctly with the 7.1 Web Samples, you must add a <code>queues</code> section containing options that duplicate the options in the <code>endpoints:&lt;tenant_dbid&gt;</code> section.</li> <li>On Solaris and AIX, Third Party Components 7.2 are required.</li> </ul>                                                              |
| Classification Server        | Yes, but Third Party Components 7.2 are required.                                                                                                                                                                                                                                                                                                                                                                  |
| Configuration Wizards (MCR)  | You can use the Multimedia 7.2 configuration wizards to upgrade individual 7.1 components. However, Genesys recommends that you not install the 7.2 wizards on the same host as the 7.1 wizards.                                                                                                                                                                                                                   |
| ESJ                          | Yes, but Third Party Components 7.2 are required.                                                                                                                                                                                                                                                                                                                                                                  |
| Interaction Server           | Yes, with the following qualifications: <ul style="list-style-type: none"> <li>The Interaction Server Application object must be of the old type <code>T-Server</code> rather than the new type <code>Interaction Server</code>.</li> <li>You must upgrade the Interaction Server database to 7.2.</li> <li>Multi-tenancy is not supported.</li> <li>There must not be a connection to Chat Server 7.1.</li> </ul> |
| Interaction Workflow Samples | No                                                                                                                                                                                                                                                                                                                                                                                                                 |
| Knowledge Manager            | Yes. However: <ul style="list-style-type: none"> <li>The FAQ functionality is not supported.</li> <li>Third Party Components 7.2 are required</li> </ul>                                                                                                                                                                                                                                                           |
| Third Party Components       | No                                                                                                                                                                                                                                                                                                                                                                                                                 |
| Training Server              | No                                                                                                                                                                                                                                                                                                                                                                                                                 |
| UCS                          | Yes, but you must upgrade the UCS database, and Third Party Components 7.2 are required                                                                                                                                                                                                                                                                                                                            |

**Table 152: Compatibility of Multimedia 7.2 with MCR 7.1 (Continued)**

| Component            | Compatible                                                                                                                                                                                                                                                                                                                                                                                                                                                                                                                                                                                                                                                                                   |
|----------------------|----------------------------------------------------------------------------------------------------------------------------------------------------------------------------------------------------------------------------------------------------------------------------------------------------------------------------------------------------------------------------------------------------------------------------------------------------------------------------------------------------------------------------------------------------------------------------------------------------------------------------------------------------------------------------------------------|
| UCS Manager          | No                                                                                                                                                                                                                                                                                                                                                                                                                                                                                                                                                                                                                                                                                           |
| UCS Transition Tool  | Yes, but Third Party Components 7.2 are required.                                                                                                                                                                                                                                                                                                                                                                                                                                                                                                                                                                                                                                            |
| Web API Server       | Yes, with the following qualifications: <ul style="list-style-type: none"> <li>• Only 7.1 functionality is available.</li> <li>• Third Party Components 7.2 are required.</li> <li>• There must not be a connection to UCS 7.1.</li> </ul>                                                                                                                                                                                                                                                                                                                                                                                                                                                   |
| Web Compound Samples | Yes, but only 7.1 functionality is available. You must also: <ul style="list-style-type: none"> <li>• Add an <code>endpoints:&lt;tenant_dbid&gt;</code> section to the Web API Server Application, where               <ol style="list-style-type: none"> <li>a. <code>&lt;tenant_dbid&gt;</code> is the ID of a valid tenant in your configuration.</li> <li>b. The section contains at least one option whose name you may invent, and whose value is the name of an existing queue in a Business Process.</li> </ol> </li> <li>• Change CodeBase71 to CodeBase72 in your applications (JSP files or Configuration Server).</li> <li>• Third Party Components 7.2 are required.</li> </ul> |

**Endpoints** For more information on endpoints, see *Universal Routing 7.2 Interaction Routing Designer Help* and the sections on media server options in the “Configuration Options” chapter of the *Multimedia 7.2 Reference Manual*.

## Multimedia 7.5 with Multimedia 7.2

Table 153 lists compatibility between 7.5 and 7.2 Multimedia components.

**Table 153: Compatibility of Multimedia 7.5 and 7.2**

| Component                    | Compatible with Multimedia 7.2?                                                                                                                                                                                                                                                                           |
|------------------------------|-----------------------------------------------------------------------------------------------------------------------------------------------------------------------------------------------------------------------------------------------------------------------------------------------------------|
| Chat Server                  | Yes, as long as the following options keep their default values: <ul style="list-style-type: none"> <li>• stop-abandoned-interaction = true</li> <li>• use-contact-server = true</li> <li>• transcript-auto-save = 0</li> </ul>                                                                           |
| Classification Server        | Yes, except that 7.5 versions of the following are required: <ul style="list-style-type: none"> <li>• UCS and the UCS database schema</li> <li>• Knowledge Manager</li> <li>• Training Server</li> <li>• Third Party Components</li> </ul>                                                                |
| Co-Browsing Server           | Yes, except that load balancing is not supported.                                                                                                                                                                                                                                                         |
| E-mail Server Java           | Yes, except that 7.5 Third Party Components is required.                                                                                                                                                                                                                                                  |
| Interaction Server           | Yes, with the following conditions: <ul style="list-style-type: none"> <li>• You must update the Interaction Server database.</li> <li>• The ignore-read-only-on-change option must be set to true (for compatibility with Agent Desktop 7.2).</li> <li>• DB Server 7.5 is strongly suggested.</li> </ul> |
| Interaction Workflow Samples | Yes.                                                                                                                                                                                                                                                                                                      |
| Knowledge Manager            | Yes, except that 7.5 versions of the following are required: <ul style="list-style-type: none"> <li>• UCS and the UCS database schema</li> <li>• Classification Server</li> <li>• Training Server</li> <li>• Third Party Components</li> </ul>                                                            |
| Third Party Components       | No.                                                                                                                                                                                                                                                                                                       |

**Table 153: Compatibility of Multimedia 7.5 and 7.2 (Continued)**

| Component                                | Compatible with Multimedia 7.2?                                                                                                                                                                                                                  |
|------------------------------------------|--------------------------------------------------------------------------------------------------------------------------------------------------------------------------------------------------------------------------------------------------|
| Training Server                          | Yes, except that 7.5 versions of the following are required: <ul style="list-style-type: none"> <li>• UCS and the UCS database schema</li> <li>• Knowledge Manager</li> <li>• Classification Server</li> <li>• Third Party Components</li> </ul> |
| Universal Contact Server                 | Yes, except that you must upgrade to 7.5 versions of the UCS database and Third Party Components.                                                                                                                                                |
| Universal Contact Server Manager         | Yes, except that Third Party Components 7.5 is required.                                                                                                                                                                                         |
| Universal Contact Server Transition Tool | Yes, except that Third Party Components 7.5 is required.                                                                                                                                                                                         |
| Web API Server                           | Yes.                                                                                                                                                                                                                                             |
| Web Compound Samples                     | Yes, except that the value for the <code>applet-code-base</code> option must be set to <code>/CodeBase75</code> .                                                                                                                                |

## Multimedia 7.6.0 with Multimedia 7.5

In general, Multimedia 7.6.0 components are compatible with Multimedia 7.5 and 7.2. Details are provided in [Table 154](#). However, note that you cannot install any Multimedia 7.6.0 component in the same directory as a Multimedia 7.5 or 7.2 component. For a mixed solution, Multimedia 7.6.0 components and older Multimedia components must be in separate directories.

**Table 154: Compatibility of Multimedia 7.6.0 and 7.5**

| Component             | Compatible with Multimedia 7.5?                            |
|-----------------------|------------------------------------------------------------|
| Chat Server           | Yes                                                        |
| Classification Server | Yes, except that Third Party Components 7.6.0 is required. |
| Co-Browsing Server    | Yes                                                        |
| E-mail Server Java    | Yes, except that Third Party Components 7.6.0 is required. |

**Table 154: Compatibility of Multimedia 7.6.0 and 7.5 (Continued)**

| Component                                          | Compatible with Multimedia 7.5?                                                                                                                                                                                                              |
|----------------------------------------------------|----------------------------------------------------------------------------------------------------------------------------------------------------------------------------------------------------------------------------------------------|
| Knowledge Manager                                  | Yes, except that Third Party Components 7.6.0 is required.                                                                                                                                                                                   |
| Interaction Server                                 | Yes                                                                                                                                                                                                                                          |
| Interaction Workflow Samples                       | Yes                                                                                                                                                                                                                                          |
| Third Party Components                             | No, cannot be deployed with Multimedia 7.5                                                                                                                                                                                                   |
| Training Server                                    | Yes, except that Third Party Components 7.6.0 is required.                                                                                                                                                                                   |
| Universal Contact Server                           | Yes, except that: <ul style="list-style-type: none"> <li>• The database must be upgraded.</li> <li>• Third Party Components 7.6.0 is required.</li> </ul>                                                                                    |
| Universal Contact Server Manager                   | Yes, except that Third Party Components 7.6.0 is required.                                                                                                                                                                                   |
| Universal Contact Server Transition Tool           | Yes, except that Third Party Components 7.6.0 is required.                                                                                                                                                                                   |
| Web API Server and .NET Web API Server and Samples | Yes, except for functionality that is new in 7.6.0                                                                                                                                                                                           |
| Web Compound Samples                               | Yes, except that: <ul style="list-style-type: none"> <li>• In the chat simple sample, typing notification does not function properly.</li> <li>• The <code>applet-code-base</code> option must be set to <code>CodeBase76</code>.</li> </ul> |

The following components have additional requirements for compatibility with Multimedia 7.2:

- Chat Server 7.6.0—the following options must have their default values (in parentheses):
  - `stop-abandoned-interaction` (`true`)
  - `use-contact-server` (`true`)
  - `transcript-auto-save` (`0`)
- Universal Contact Server Manager—UCS 7.5 or later is required.
- Interaction Server—the database must use the 7.5 or later schema, and DB Server 7.5 or later is strongly recommended.



- Knowledge Management components—at least 7.5 versions of the following are required:
  - UCS and the UCS database schema
  - All other Knowledge Management components (that is, Classification Server 7.6.0 requires Knowledge Manager and Training Server 7.5, Knowledge Manager 7.6.0 requires Classification Server and Training Server 7.5, and so on).

## Multimedia 7.6.1 with Multimedia 7.6.0

In general, Multimedia 7.6.1 components are compatible with Multimedia 7.6.0 and 7.5. Details are provided in [Table 155](#). However, note that you cannot install any Multimedia 7.6.1 component in the same directory as a Multimedia 7.6.0 or 7.5 component. For a mixed solution, Multimedia 7.6.1 components and older Multimedia components must be in separate directories.

**Table 155: Compatibility of Multimedia 7.6.1 and 7.6.0**

| Component                    | Compatible with Multimedia 7.6.0?                                                                                                  |
|------------------------------|------------------------------------------------------------------------------------------------------------------------------------|
| Chat Server                  | Yes                                                                                                                                |
| Classification Server        | Yes, except that Third Party Components 7.6.1 is required.                                                                         |
| Co-Browsing Server           | Yes                                                                                                                                |
| E-mail Server Java           | Yes, except that Third Party Components 7.6.1 is required.                                                                         |
| Knowledge Manager            | Yes, except that Third Party Components 7.6.1 is required.                                                                         |
| Interaction Server           | Yes, except that you must update the Interaction Server database (see “Interaction Server Database” on <a href="#">page 921</a> ). |
| Interaction Server Proxy     | Yes                                                                                                                                |
| Interaction Workflow Samples | Yes                                                                                                                                |
| Third Party Components       | No                                                                                                                                 |
| Training Server              | Yes, except that Third Party Components 7.6.1 is required.                                                                         |

**Table 155: Compatibility of Multimedia 7.6.1 and 7.6.0 (Continued)**

| Component                                | Compatible with Multimedia 7.6.0?                                                                                                                                                                                                                             |
|------------------------------------------|---------------------------------------------------------------------------------------------------------------------------------------------------------------------------------------------------------------------------------------------------------------|
| Universal Contact Server                 | Yes, except: <ul style="list-style-type: none"> <li>• The database must be upgraded (see “UCS Database” on <a href="#">page 920</a>).</li> <li>• Third Party Components 7.6.1 is required.</li> <li>• Not compatible with Knowledge Manager 7.6.0.</li> </ul> |
| Universal Contact Server Manager         | Yes, except that Third Party Components 7.6.1 is required.                                                                                                                                                                                                    |
| Universal Contact Server Proxy           | Yes                                                                                                                                                                                                                                                           |
| Universal Contact Server Transition Tool | Yes, except that Third Party Components 7.6.1 is required.                                                                                                                                                                                                    |
| Web API Server                           | Yes                                                                                                                                                                                                                                                           |
| .NET Web API Server and Samples          | Yes, except for incompatibility with treatment of contact ID in the Platform SDK                                                                                                                                                                              |
| Web Compound Samples                     | Yes                                                                                                                                                                                                                                                           |

### Multimedia 8.0 with Multimedia 7.6.x

In general, Multimedia 8.0 components are compatible with Multimedia 7.6.x. Details are provided in [Table 155](#). However, note that you cannot install any Multimedia 8.0 component in the same directory as a Multimedia 7.6.x. For a mixed solution, Multimedia 8.0 components and older Multimedia components must be in separate directories.

**Table 156: Compatibility of Multimedia 8.0 and 7.6.x**

| Component             | Compatible with Multimedia 7.6.x?                        |
|-----------------------|----------------------------------------------------------|
| Chat Server           | Yes                                                      |
| Classification Server | Yes, except that Third Party Components 8.0 is required. |
| Co-Browsing Server    | Yes                                                      |

**Table 156: Compatibility of Multimedia 8.0 and 7.6.x (Continued)**

| Component                                | Compatible with Multimedia 7.6.x?                                                                                                                                                                                                                                      |
|------------------------------------------|------------------------------------------------------------------------------------------------------------------------------------------------------------------------------------------------------------------------------------------------------------------------|
| E-mail Server Java                       | Yes, except that Third Party Components 8.0 is required.                                                                                                                                                                                                               |
| Knowledge Manager                        | Yes, except that Third Party Components 8.0 is required.                                                                                                                                                                                                               |
| Interaction Server                       | Yes                                                                                                                                                                                                                                                                    |
| Interaction Server Proxy                 | Yes                                                                                                                                                                                                                                                                    |
| Interaction Workflow Samples             | Yes                                                                                                                                                                                                                                                                    |
| SMS Server                               | No                                                                                                                                                                                                                                                                     |
| Third Party Components                   | No                                                                                                                                                                                                                                                                     |
| Training Server                          | Yes, except that Third Party Components 8.0 is required.                                                                                                                                                                                                               |
| Universal Contact Server                 | Yes, except: <ul style="list-style-type: none"> <li>• UCS 8.0 is not compatible with Knowledge Manager 7.6.0.</li> <li>• The database must be upgraded (see “UCS Database” on <a href="#">page 920</a>).</li> <li>• Third Party Components 8.0 is required.</li> </ul> |
| Universal Contact Server Manager         | Yes, except that Third Party Components 8.0 is required.                                                                                                                                                                                                               |
| Universal Contact Server Proxy           | Yes                                                                                                                                                                                                                                                                    |
| Universal Contact Server Transition Tool | Yes, except that Third Party Components 8.0 is required.                                                                                                                                                                                                               |
| Web API Server                           | Yes                                                                                                                                                                                                                                                                    |
| .NET Web API Server and Samples          | Yes                                                                                                                                                                                                                                                                    |





## Chapter

# 52

## Changes in Components and Configuration Options

This section provides information that you need to upgrade components and configuration options from MCR release 7.0 to MCR 7.1, from MCR release 7.1 to Multimedia 7.2, and from Multimedia release 7.2 to 7.5, 7.5 to 7.6.0, 7.6.0 to 7.6.1, and 7.6.1 to 8.0. This section only discusses changes (additions, deletions, and modifications) in the product that you may need to address during the migration process. The product documentation for each release contains a comprehensive list of changes from release to release, in the following:

- The chapters on configuration options in the reference manual for Multimedia 7.2, 7.5, 7.6, and 8.0
- The overview chapters in the deployment guide for Multimedia 7.2, 7.5, and 7.6, and 8.0.

---

**Note:** Genesys does not issue separate documentation sets for “second point” releases (such as 7.6.1 versus 7.6.0), but documents are updated for these releases. To find descriptions of changes and additions in release 7.6.1, consult documents whose part number includes the string *7.6.1*—for example, *76mm\_us\_01-2009\_v7.6.101.00*. The part number is at the bottom of page 2 in PDF documents, and in the “About This File” topic in Help files.

---

There are two sections in this chapter:

- [Component Changes, page 898](#)
- [Changes to Configuration Options, page 899](#)

---

# Component Changes

This section describes changes in MCR and Multimedia components that have consequences for configuration.

## Multi-Channel Routing 7.1

Interaction Workflow Designer (IWD) is an independent component of MCR 7.0. In the 7.1 release, IWD is a part of Interaction Routing Designer (IRD), which is a component of Genesys Universal Routing. The functioning of the IWD portion of IRD 7.1 is generally the same as that of IWD 7.0. For details, see the *Universal Routing 7.1 Business Process User's Guide*.

There are no other component changes between Multi-Channel Routing 7.0 and 7.1.

## Multimedia 7.2

In the 7.2 release, Interaction Server has a new Application type in the Configuration Layer, namely `Interaction Server`. This allows it to operate in a multi-tenant environment. For backward compatibility, Interaction Server can also be of type `T-Server`. For details, see the sections on Interaction Server in the “Multi-Tenancy” and “Ongoing Administration” chapters of the *Multimedia 7.2 User's Guide*.

Multimedia 7.2 adds web collaboration (sometimes also called conavigation or co-browsing) as an optional functionality. The component that supports this new functionality is called Co-browsing Server. If you have Genesys Web Collaboration, Co-browsing Server is installed as part of the integrated installation.

### Changes in Connections

In Multimedia 7.2, there are the following changes in connections that you can configure between components:

- Chat Server 7.2 supports the External Services Protocol (ESP) for submitting text messages from routing strategies. To enable this feature, Interaction Server must have a connection to Chat Server.
- A new feature in Multimedia 7.2 allows users to access UCS data such as contact history via a secure website. To enable this feature, Web API Server must have a connection to UCS.

## Multimedia 7.5

There are no relevant component changes in release 7.5.

## Multimedia 7.6.0

There are no relevant component changes in release 7.6.0.

## Multimedia 7.6.1

This release adds the following components:

- Interaction Proxy Server
- UCS Proxy Server

### Changes in Connections

In Multimedia 7.6.1, the new Event Logger functionality requires a DAP (Database Access Point) for each logger database. You should connect Interaction Server to each such DAP. For details on the Event Logger, see the “Event Logger” section in the “Interaction Server: Advanced Topics” section of the “Ongoing Administration and Other Topics” chapter of the *Multimedia 7.6 User’s Guide*.

## Multimedia 8.0

In this release:

- SMS Server is added.
- The Simple Samples have been extended, and Web Compound Samples are discontinued.

---

# Changes to Configuration Options

## Multi-Channel Routing Changes from 7.0 to 7.1

[Table 157](#) lists changes to the options for specific components of Multi-Channel Routing between releases 7.0 and 7.1. For complete descriptions of all

MCR options, and a list of retired options in release 7.1, see the *Multi-Channel Routing 7.1 Reference Manual*.

**Table 157: Configuration Option Changes from 7.0 to 7.1**

| Component Name                 | Section/Option                             | Type of Change                                               |
|--------------------------------|--------------------------------------------|--------------------------------------------------------------|
| Universal Contact Server (UCS) | settings/enable-reporting                  | New option                                                   |
|                                | settings/fieldcode-format-locale           | New option                                                   |
|                                | settings/hide-attached-data                | Default changed from <code>false</code> to <code>true</code> |
|                                | settings/log-memory-usage                  | New option                                                   |
|                                | settings/primary-attribute-lookup-strategy | New option                                                   |
|                                | settings/retry-on-deadlock                 | New option                                                   |
|                                | DAP object: options/max-connections        | Default changed from 0 to 40                                 |
|                                | DAP object: options/max-idle-time          | Default changed from 0 to 310                                |
|                                | DAP object: JDBC info/QueryTimeout         | Recommendation changed from 60 to 120                        |
| Interaction Server             | settings/ignore-read-only-on-submit        | New option                                                   |
|                                | settings/not-ready-on-invitation-timeout   | New option                                                   |
| Web API Server                 | no changes                                 |                                                              |
| Web Compound Samples           | miscellaneous/tenant                       | Default value changed from <Tenant_Name> to No default value |
|                                | miscellaneous/applets-code-base            | Default value changed from /CodeBase70 to /CodeBase71        |
| Chat Server                    | no changes                                 |                                                              |



**Table 157: Configuration Option Changes from 7.0 to 7.1 (Continued)**

| Component Name        | Section/Option                                     | Type of Change                                                 |
|-----------------------|----------------------------------------------------|----------------------------------------------------------------|
| E-mail Server Java    | email-processing/autowar-detect-period             | New option                                                     |
|                       | email-processing/default-from-address              | New option                                                     |
|                       | email-processing/enable-autowar-detect             | New option                                                     |
|                       | email-processing/enable-extract                    | New option                                                     |
|                       | email-processing/fieldcode-format-locale           | New option                                                     |
|                       | email-processing/hide-attached-data                | Default changed from <code>false</code> to <code>true</code>   |
|                       | email-processing/inbound-processor-high-watermark  | Default changed from <code>50</code> to <code>200</code>       |
|                       | email-processing/inbound-processor-low-watermark   | Default changed from <code>10</code> to <code>20</code>        |
|                       | email-processing/inbound-submitter-high-watermark  | Default changed from <code>50</code> to <code>200</code>       |
|                       | email-processing/inbound-submitter-low-watermark   | Default changed from <code>10</code> to <code>20</code>        |
|                       | email-processing/outbound-submitter-high-watermark | Default changed from <code>50</code> to <code>200</code>       |
|                       | email-processing/outbound-submitter-low-watermark  | Default changed from <code>10</code> to <code>20</code>        |
|                       | email-encoding/x-user-defined                      | Valid values changed to any encoding supported by JRE 1.4.2    |
|                       | settings/cnx-to-ucs-wait-time                      | New option                                                     |
|                       | settings/max-cnx-to-ucs                            | New option                                                     |
| Classification Server | engine/log-level                                   | Default changed from <code>all</code> to <code>standard</code> |
|                       | engine/model-check-interval                        | Units changed from minutes to seconds (default unchanged)      |

**Table 157: Configuration Option Changes from 7.0 to 7.1 (Continued)**

| Component Name    | Section/Option              | Type of Change                                            |
|-------------------|-----------------------------|-----------------------------------------------------------|
| Training Server   | engine/log-level            | Default changed from all to standard                      |
|                   | engine/model-check-interval | Units changed from minutes to seconds (default unchanged) |
| Knowledge Manager | general/update-cfg          | New option                                                |

## Multi-Channel Routing 7.1 to Multimedia 7.2

[Table 158](#) lists changes to the options for specific components between MCR 7.1 and Multimedia 7.2. For complete descriptions of all Multimedia options, and a list of retired options in release 7.2, see the *Multimedia 7.2 Reference Manual*.

**Table 158: Configuration Option Changes from 7.1 to 7.2**

| Component Name                 | Section/Option                          | Type of Change                                                 |
|--------------------------------|-----------------------------------------|----------------------------------------------------------------|
| Universal Contact Server (UCS) | settings/archiving-nb-records-per-task  | New option                                                     |
|                                | settings/archiving-task-pool-size       | New option                                                     |
| Interaction Server             | settings/delay-updates                  | New option                                                     |
|                                | settings/third-party-server-queue-size  | New option                                                     |
|                                | settings/third-party-server-window-size | New option                                                     |
| Web API Server                 | endpoints:<tenant_dbid>/default         | New section and option                                         |
| Web Compound Samples           | miscellaneous/applets-code-base         | The default value was changed from /CodeBase71 to /CodeBase72. |
| Chat Server                    | endpoints:<tenant_dbid>/default         | New section and option                                         |
|                                | esp-settings/esp-default-nickname       | New section and option                                         |
|                                | esp-settings/esp-server-port            | New section and option                                         |

**Table 158: Configuration Option Changes from 7.1 to 7.2 (Continued)**

| Component Name        | Section/Option                                       | Type of Change         |
|-----------------------|------------------------------------------------------|------------------------|
| E-mail Server Java    | email-processing/autowar-max-reply-count             | New option             |
|                       | email-processing/autowar-scan-all-threads-of-contact | New option             |
|                       | email-processing/enable-big-msg-stripping            | New option             |
|                       | email-processing/quote-prefix                        | New option             |
|                       | pop-client/endpoint                                  | New option             |
|                       | iwe-processing/endpoint                              | New option             |
|                       | endpoints:<tenant_dbid>/default                      | New section and option |
|                       | endpoints:<tenant_dbid>/endpoint-name-1              | New section and option |
|                       | endpoints:<tenant_dbid>/endpoint-name-2              | New section and option |
| Classification Server | settings/hide-attached-data                          | New section and option |
| Training Server       | No changes                                           |                        |
| Knowledge Manager     | No changes                                           |                        |
| UCS Manager           | No changes                                           |                        |

## Multimedia 7.2 to 7.5

Table 159 lists changes to the options for specific components between Multimedia 7.2 and 7.5. For complete descriptions of all Multimedia options, and a list of retired options in release 7.5, see the *Multimedia 7.5 Reference Manual*.

**Table 159: Configuration Option Changes from Multimedia 7.2 to 7.5**

| Component Name                 | Section/Option                             | Type of Change                                                                    |
|--------------------------------|--------------------------------------------|-----------------------------------------------------------------------------------|
| Universal Contact Server (UCS) | settings/allow-missing-index               | New option                                                                        |
|                                | settings/allow-additional-column           | New option                                                                        |
|                                | settings/srl-cache-load-attachment-summary | New option                                                                        |
|                                | settings/ucsapi-backlog                    | New option                                                                        |
|                                | settings/ucsapi-duplex-mode                | New option                                                                        |
|                                | DAP object (JDBC): inactive-scroll-timeout | New option                                                                        |
|                                | DAP object (JDBC): inactive-txn-timeout    | New option                                                                        |
|                                | DAP object (JDBC): login-timeout           | Previously undocumented option                                                    |
|                                | DAP object (JDBC): long-query-timeout      | Previously undocumented option                                                    |
|                                | DAP object (JDBC): connection-failed-retry | Previously undocumented option                                                    |
|                                | DAP object (JDBC): service                 | Previously undocumented option                                                    |
| Co-Browsing Server             | General/DebugMode                          | Removed                                                                           |
|                                | General/web-server-host                    | New option                                                                        |
| Interaction Server             | settings/routing-timeout                   | Maximum value increased to 525,600                                                |
|                                | log-control                                | New section with four new options; see the <i>Multimedia 7.5 Reference Manual</i> |
|                                | settings/ignore-read-only-on-change        | New option                                                                        |
|                                | settings/allow-duplicates-in-change        | New option                                                                        |
| Web API Server                 | No changes                                 |                                                                                   |

**Table 159: Configuration Option Changes from Multimedia 7.2 to 7.5 (Continued)**

| Component Name        | Section/Option                          | Type of Change                                                                       |
|-----------------------|-----------------------------------------|--------------------------------------------------------------------------------------|
| Web Compound Samples  | applets-code-base                       | Default changed to /CodeBase75                                                       |
| Chat Server           | settings/stop-abandoned-interaction     | New option                                                                           |
|                       | settings/transcript-auto-save           | New option                                                                           |
|                       | settings/use-contact-server             | New option                                                                           |
|                       | settings/user-register-timeout          | New option                                                                           |
| E-mail Server Java    | mime-customization                      | New section with eight new options; see the <i>Multimedia 7.5 Reference Manual</i> . |
|                       | email-processing/contact-identification | New option                                                                           |
|                       | email-processing/enable-mail-loops      | New option                                                                           |
|                       | email-processing/quote-from.            | New option                                                                           |
|                       | email-processing/quote-sent             | New option                                                                           |
|                       | email-processing/quote-subject          | New option                                                                           |
|                       | email-processing/subject-forward-prefix | New option                                                                           |
|                       | email-processing/subject-reply-prefix   | New option                                                                           |
|                       | pop-client/allow-bad-msg-size           | New option                                                                           |
|                       | settings/ucs-duplex-mode                | New option                                                                           |
| Classification Server | cengine/subject-body-header             | New option                                                                           |
|                       | license/license-file                    | New section and option                                                               |
| Training Server       | cengine/model-check-interval            | Default changed from 1 to 30                                                         |
| Knowledge Manager     | general/subject-body-header             | New option                                                                           |
| UCS Manager           | No changes                              |                                                                                      |

## Multimedia 7.5 to 7.6.0

[Table 160](#) lists changes to the options for specific components between Multimedia 7.5 and 7.6.0. For complete descriptions of all Multimedia options,

see the *Multimedia 7.6 Reference Manual*. There were no retired options in release 7.6.0.

**Table 160: Configuration Option Changes from Multimedia 7.5 to 7.6.0**

| Component Name        | Section/Option                                   | Type of Change                                                              |
|-----------------------|--------------------------------------------------|-----------------------------------------------------------------------------|
| Chat Server           | settings/web-user-max-messages                   | New option                                                                  |
|                       | settings/xml-request-max-size                    | New option                                                                  |
| Classification Server | No changes                                       |                                                                             |
| Co-Browsing Server    | No changes                                       |                                                                             |
| E-mail Server Java    | email-processing/enable-message-id-check         | New option                                                                  |
|                       | email-processing/enable-same-mail-from-mailboxes | New option                                                                  |
| Interaction Server    | log-filter                                       | New section, with new option <code>default-filter-type</code>               |
|                       | log-filter-data                                  | New section                                                                 |
|                       | settings/default-view-freeze-interval            | New option                                                                  |
|                       | settings/low-pull-threshold                      | New option                                                                  |
|                       | settings/high-pull-threshold                     | New option                                                                  |
|                       | settings/submit-timer-interval                   | New option                                                                  |
|                       | freeze-interval                                  | New option in Interaction Queue View object (View section of the Annex tab) |
| Knowledge Manager     | update-cfg                                       | Default changed to <code>true</code>                                        |
| Training Server       | No changes                                       |                                                                             |
| UCS Manager           | No changes                                       |                                                                             |

**Table 160: Configuration Option Changes from Multimedia 7.5 to 7.6.0 (Continued)**

| Component Name                 | Section/Option                                   | Type of Change                                  |
|--------------------------------|--------------------------------------------------|-------------------------------------------------|
| Universal Contact Server (UCS) | settings/log-db-flow-rate                        | New option                                      |
|                                | settings/openmedia-create-full-interaction       | New option                                      |
|                                | settings/synchronize-cache                       | New option                                      |
|                                | settings/synchronize-contact-metadata-attributes | New option                                      |
|                                | settings/synchronize-ixn-attributes              | New option                                      |
|                                | settings/synchronize-ixn-metadata-attributes     | New option                                      |
|                                | settings/ucsapi-loopback-timeout                 | New option                                      |
| Web API Server                 | No changes                                       |                                                 |
| Web Compound Samples           | miscellaneous/applets-code-base                  | Default changed from /CodeBase75 to /CodeBase76 |

## Multimedia 7.6.0 to 7.6.1

[Table 161](#) lists changes to the options for specific components between Multimedia 7.6.0 and 7.6.1. For complete descriptions of all Multimedia options, see the *Multimedia 7.6 Reference Manual*. There were no retired options in release 7.6.1.

**Table 161: Configuration Option Changes from Multimedia 7.6.0 to 7.6.1**

| Component Name        | Section/Option | Type of Change |
|-----------------------|----------------|----------------|
| Chat Server           | No changes     |                |
| Classification Server | No changes     |                |
| Co-Browsing Server    | No changes     |                |
| E-mail Server Java    | No changes     |                |

**Table 161: Configuration Option Changes from Multimedia 7.6.0 to 7.6.1 (Continued)**

| Component Name                 | Section/Option                                | Type of Change                                                                                                            |
|--------------------------------|-----------------------------------------------|---------------------------------------------------------------------------------------------------------------------------|
| Interaction Server             | settings/max-workbin-interactions             | New option                                                                                                                |
|                                | DAP Object for Event Logger: esp-custom-data  | New section                                                                                                               |
|                                | DAP Object for Event Logger: esp-service-data | New section                                                                                                               |
|                                | DAP Object for Event Logger: event-filtering  | New section, with options log-agent-activity, log-agent-state, log-esp-service, log-queue, log-strategy, and log-userdata |
|                                | DAP Object for Event Logger: itx-custom-data  | New section                                                                                                               |
|                                | DAP Object for Event Logger: logger-settings  | New section, with options batch-size, mandatory-logging, max-queue-size, and storing-timeout                              |
| Interaction Server Proxy       | All                                           | New component                                                                                                             |
| Knowledge Manager              | No changes                                    |                                                                                                                           |
| Training Server                | No changes                                    |                                                                                                                           |
| UCS Manager                    | No changes                                    |                                                                                                                           |
| Universal Contact Server (UCS) | log-memory-usage                              | Default changed from FALSE to TRUE                                                                                        |
|                                | log-db-flow-rate                              | Default changed from FALSE to TRUE                                                                                        |
|                                | settings/convert-idn-to-unicode               | New option                                                                                                                |
|                                | settings/replace-blank-fieldcode              | New option                                                                                                                |
| Universal Contact Server Proxy | All                                           | New component                                                                                                             |
| Web API Server                 | No changes                                    |                                                                                                                           |
| Web Compound Samples           | miscellaneous/applets-code-base               | Default changed from /CodeBase76 to /CodeBase761                                                                          |



## Multimedia 7.6.1 to 8.0

Table 161 lists changes to the options for specific components between Multimedia 7.6.1 and 8.0. For complete descriptions of all Multimedia options, see the *Multimedia 8.0 Reference Manual*. There were no retired options in release 8.0.

**Table 162: Configuration Option Changes from Multimedia 7.6.1 to 8.0**

| Component Name           | Section/Option                               | Type of Change                                                                                                   |
|--------------------------|----------------------------------------------|------------------------------------------------------------------------------------------------------------------|
| Chat Server              | No changes                                   |                                                                                                                  |
| Classification Server    | No changes                                   |                                                                                                                  |
| Co-Browsing Server       | No changes                                   |                                                                                                                  |
| E-mail Server Java       | outbound-collaboration-invite                | New section, with options attach-parent-email, attach-parent-email-masquerading-from-address, quote-parent-email |
|                          | email-processing/cc-userdata-limit           | New option                                                                                                       |
|                          | pop-client, smtp-client                      | New option enable-starttls added to both sections                                                                |
| Interaction Server       | udata-filters                                | New section, with options esp, agent, reporting, router                                                          |
|                          | licensing/ics_sms_channel                    | New option                                                                                                       |
|                          | settings/no-userdata-changed-response-to-urs | New option                                                                                                       |
|                          | settings/notify-workbin-userdata-changed     | New option                                                                                                       |
|                          | settings/number-of-database-connections      | New options                                                                                                      |
| Interaction Server Proxy | No changes                                   |                                                                                                                  |
| Knowledge Manager        | No changes                                   |                                                                                                                  |
| SMS Server               | All new                                      | New component                                                                                                    |

**Table 162: Configuration Option Changes from Multimedia 7.6.1 to 8.0 (Continued)**

| Component Name                 | Section/Option                                 | Type of Change                                                                                    |
|--------------------------------|------------------------------------------------|---------------------------------------------------------------------------------------------------|
| Training Server                | No changes                                     |                                                                                                   |
| UCS Manager                    | No changes                                     |                                                                                                   |
| Universal Contact Server (UCS) | settings/enable-reporting                      | Default changed from TRUE to FALSE                                                                |
|                                | settings/ucsapi-custom-socket                  | New option                                                                                        |
|                                | index                                          | New section, with option enabled                                                                  |
|                                | index.contact, index., interaction, index.srl. | New sections, each with options description, enabled, index-rebuild, max-result, and storage-path |
| UCS Proxy                      | No changes                                     |                                                                                                   |
| Web API Server                 | No changes                                     |                                                                                                   |
| Web Compound Samples           | All removed                                    | Component removed                                                                                 |



## Chapter

# 53

## Migration Procedures

This chapter discusses the migration procedures from MCR 7.0 to 7.1, from MCR 7.1 to Multimedia 7.2, and from Multimedia releases 7.2 to 7.5, 7.5 to 7.6.0, and 7.6.0 to 7.6.1, in these sections:

- [Overview, page 911](#)
- [Migration Procedures, page 914](#)

---

## Overview

Complete these preliminary procedures before starting your migration.

### MCR 7.0 to MCR 7.1

1. Installation of Licensing Manager XML, version 8.3
2. You should have the license files for 7.1 components.  
Licensing is addressed in these documents:
  - *Genesys Licensing Guide*
  - “Licensing Migration” on [page 41](#) of this guide.

---

**Note:** The only difference between MCR 7.0 and 7.1 regarding licensing is the addition of a license for Open Media:  
`ics_custom_media_channel`.

---

3. Migration of Framework to the versions required by MCR. See “Compatibility Between Multimedia/MCR and Genesys Framework” on [page 885](#).
4. Upgrade of other prerequisite Genesys components.

## MCR 7.1 to Multimedia 7.2

1. Install FLEXlm license manager. For the currently-supported version, check the *Genesys Licensing Guide*.
2. You should have the license files for 7.2 components.

Licensing is addressed in these documents:

- *Genesys Licensing Guide*: “Licensing Requirements” chapter.
- “Licensing Migration” on [page 41](#) of this guide.

---

**Note:** There is no difference between MCR 7.1 and Multimedia 7.2 regarding licensing.

---

3. Migrate Framework to the versions required by Multimedia. See “Compatibility Between Multimedia/MCR and Genesys Framework” on [page 885](#).
4. Upgrade other prerequisite Genesys components.

## Multimedia 7.2 to 7.5

1. Install FLEXlm license manager. For the currently-supported version, check the *Genesys Licensing Guide*.
2. You should have the license files for 7.5 components.

Licensing is addressed in these documents:

- *Genesys Licensing Guide*: “Licensing Requirements” chapter.
- “Licensing Migration” on [page 41](#) of this guide.

---

**Note:** There is no difference between Multimedia 7.2 and 7.5 regarding licensing.

---

3. Migrate Framework to the versions required by Multimedia. See “Compatibility Between Multimedia/MCR and Genesys Framework” on [page 885](#).
4. Upgrade other prerequisite Genesys components.

## Multimedia 7.5 to 7.6.0

1. Install FLEXlm license manager. For the currently-supported version, check the *Genesys Licensing Guide*.
2. You should have the license files for 7.6.0 components.

Licensing is addressed in these documents:

- *Genesys Licensing Guide*: “Licensing Requirements” chapter.
- “Licensing Migration” on [page 41](#) of this guide.

---

**Note:** There is one difference between Multimedia 7.5 and 7.6.0 regarding licensing: In 7.6.0, the optional Content Analyzer - Japanese requires its own license file.

---

3. Migrate Framework to the versions required by Multimedia. See “Compatibility Between Multimedia/MCR and Genesys Framework” on [page 885](#).
4. Upgrade other prerequisite Genesys components.

## Multimedia 7.6.0 to 7.6.1

1. Install FLEXlm license manager. For the currently-supported version, check the *Genesys Licensing Guide*.
2. You should have the license files for 7.6.1 components.  
Licensing is addressed in these documents:
  - *Genesys Licensing Guide*: “Licensing Requirements” chapter.
  - “Licensing Migration” on [page 41](#) of this guide.

---

**Note:** There is no difference between Multimedia 7.6.0 and 7.6.1 regarding licensing.

---

3. Migrate Framework to the versions required by Multimedia. See “Compatibility Between Multimedia/MCR and Genesys Framework” on [page 885](#).
4. Upgrade other prerequisite Genesys components.

## Multimedia 7.6.1 to 8.0

1. Install FLEXlm license manager. For the currently-supported version, check the *Genesys Licensing Guide*.
2. You should have the license files for 8.0 components.  
Licensing is addressed in these documents:
  - *Genesys Licensing Guide*: “Licensing Requirements” chapter.
  - “Licensing Migration” on [page 41](#) of this guide.

---

**Note:** Multimedia 8.0 adds a license for SMS media: `ics_sms_channel`.

---

3. Migrate Framework to the versions required by Multimedia. See “Compatibility Between Multimedia/MCR and Genesys Framework” on [page 885](#).
4. Upgrade other prerequisite Genesys components.

---

# Migration Procedures

Follow these migration procedures for your solution. Except where noted, these procedures are the same for migrating from any major release to the next major release (that is, 7.0 to 7.1, 7.1 to 7.2, 7.2 to 7.5, 7.5 to 7.6, and 7.6 to 8.0)

## Contact Center Information

Update Contact Center configuration as needed, such as Place Groups and Agent Groups.

## Solution and Components

There are two possible approaches:

- **New Solution with new Applications:** Create and install a new Solution containing new Applications. Then install new components to all Applications in the new Solution.
- **New Solution with upgraded Applications:** Create a new Solution, then upgrade some or all existing Applications for use in the new solution, then install new components to the new Applications.

The second procedure is described in this section, but Genesys recommends the first approach unless you have specific reasons to avoid it.

With either approach, you will upgrade your Universal Contact Server and Interaction Server databases. Because you will migrate the Universal Contact Server database, all objects that you created with your old Knowledge Manager (categories, screening rules, standard responses, classification models) will be available in the new solution.

It is also theoretically possible to mix new (for example, 7.2) and existing (for example, 7.1) components in the new Solution. See “Changes in Components and Configuration Options” on [page 897](#) for compatibility relations between components. If you want to follow this combined approach you must contact Genesys Technical Support for assistance.

### New Solution with New Applications

This procedure is described in the *Deployment Guide* for each major release.

### New Solution with Upgraded Applications

First prepare as follows:

1. Import the Solution template for the new solution and use it to create a Solution object for your new installation.
2. Install configuration wizards for the new solution.

For each Application, proceed as follows:

1. Export the configuration data to a file. Keep this file available.
2. Upgrade the Application objects, using one of these methods:
  - Use the Solution Upgrade Wizard. This takes you through the individual Upgrade Wizard (next item) for each Application in the solution.
  - Use individual component Upgrade Wizards. This takes your existing Application object, displays its settings, and gives you the opportunity to modify them.

---

**Note:** The Upgrade Wizard adds any new options, but it does not change any of your existing settings, even if they are defaults whose values have changed in the new versions.

---

- Configure the Application manually. You can import the new template for the Application and check to see which options were changed or added.
3. For each component, compare the existing options and values with the changes in the inventory of options and their values (default value and range of valid values) to see if you want to modify or add to your existing configuration.

---

**Note:** If objects and components have been customized, contact Genesys Professional Services for help.

---

4. For Multimedia 7.2, update connections of Interaction Server and Web API Server if necessary (see “Changes in Connections” on [page 898](#)).
5. **Rollback Procedures:** If the upgrade of the component fails, revert to your existing Application object, as follows:
  - Restore the option values if necessary by importing the configuration data file that you created for this component in Step 1.
  - Remove any connections that you added in Step 4.

In addition to this general procedure, note the following information for specific components.

### MCR 7.1

- Universal Contact Server (UCS)—New and changed options. You must also upgrade your UCS database, as described in the next section.
- Interaction Server—New options. You must also upgrade your Interaction Server database, as described in the next section.
- Web API Server—No changes.
- Web Compound Samples—Changed options.

- Chat Server—no changes.
- E-mail Server Java—New and changed options.
- Classification Server—Changed options.
- Training Server—Changed option.
- Knowledge Manager—New option.

### **Multimedia 7.2**

- Universal Contact Server (UCS)—New options. You must also upgrade your UCS database, as described in the next section.
- Interaction Server—New options. You must also upgrade your Interaction Server database, as described in the next section.
- Web API Server—New section and option.
- Web Compound Samples—Changed option.
- Chat Server—New sections and options.
- E-mail Server Java—New section and options.
- Classification Server—New section and option.

### **Multimedia 7.5**

- Universal Contact Server (UCS)—New options. You must also upgrade your UCS database, as described in the next section.
- Co-Browsing Server—New option and removed option.
- Interaction Server—New and changed options, and new section. You must also upgrade your Interaction Server database, as described in the next section.
- Web Compound Samples—Changed default value of option.
- Chat Server—New options.
- E-mail Server Java—New section and options.
- Classification Server—New section and options.
- Training Server—Changed default value of option.
- Knowledge Manager—New option.

### **Multimedia 7.6.0**

- Chat Server—New options.
- E-mail Server Java—New options.
- Interaction Server—New options and section.
- Knowledge Manager—Changed default value for one option.
- Universal Contact Server (UCS)—New options. You must also upgrade your UCS database, as described in the next section.



- Web Compound Samples—Changed default value for one option.

### Multimedia 7.6.1

- Interaction Server—New options and sections. You must also upgrade your Interaction Server database, as described in the next section. Changes in the Interaction Server database also entail changes in certain configuration objects, also described in the next section.
- Universal Contact Server (UCS)—Changed default value for two options. You must also upgrade your UCS database, as described in the next section.
- Web Compound Samples—Changed default value for one option.

### Multimedia 8.0

- E-mail Server Java—New section and options.
- Interaction Server. New section and options.
- SMS Server. New component.
- Universal Contact Server—new section, new options, change in default value of one option.
- Web Compound Samples—Component removed.

For new or changed options, see “Changes to Configuration Options” on [page 899](#).

## Databases

You must upgrade the database schema for your Universal Contact Server (UCS) and Interaction Server databases. In each case a script is provided with the installation.

### 7.0 to 7.1

#### UCS Database

1. Make a backup copy of your UCS 7.0.x database.
2. Install UCS 7.1.
3. Go to the directory containing your UCS 7.1. Normally this is something like `C:\GCTI\Universal Contact Server\<application_object_name>`.
4. In the `sql_scripts` directory, open the directory named for your database management system.
5. The next steps differ depending on which database management system you are using.
  - For MSSQL or Oracle: Run the script `upgrade_<dbms_name>_7.0.1_to_7.1.0.sql`.

- For DB2: Run the shell script `upgrade_db2_7.0.1_to_7.1.0.sh`. Note also the following about this shell script:
  - It requires the file `upgrade_db2_7.0.1_to_7.1.0.db2`, which is located in the same directory.
  - It must be run on a machine that has access to the UCS database.
  - You must ensure that your environment is properly configured for running the DB2 command line processor (the script launches the DB2 command line processor).

---

### Warning!

- The upgrade script must run only once on the database. If you start the script, then attempt to start it again while the first instance is still in progress, the database may be damaged.
  - For Oracle and DB2, the script includes a safety mechanism: the script stops and an error message displays.
  - For MSSQL, there is no safety mechanism. The database will be damaged and you must make restore it from your backup copy, then run the upgrade script from the beginning.
- 

For all supported DBMS, if the script has completed its run successfully and you later attempt to run it again, it stops and displays a message stating that you cannot run it a second time.

### Interaction Server Database

1. Install Interaction Server 7.1.
2. Go to the directory containing your Interaction Server. Normally this is something like `C:\GCTI\Interaction Server\<application_object_name>`.
3. In the `Script` directory, open the directory named for your database management system (Db2, MsSQL, or Oracle).
4. Run the script `isdb_<dbms_name>_7.0-7.1.sql`.

## 7.1 to 7.2

### UCS Database

1. Make a backup copy of your UCS 7.1 database.
2. Install UCS 7.2.
3. Go to the directory containing your UCS 7.2. Normally this is something like `C:\GCTI\Universal Contact Server\<application_object_name>`.
4. In the `sql_scripts` directory, open the directory named for your database management system.

5. Run the script `upgrade_<dbms_name>_7.1_to_7.2.sql`.

---

**Warning!**

- Genesys recommends that you run the upgrade script only once on the database. If you run the script a second time, the database will not be modified but some errors will display.
  - If you attempt to start the script while an instance of it is still in progress, there is no effect on Oracle and MS-SQL databases.
  - If you attempt to start the script while an instance of it is still in progress, DB2 databases can be damaged. If this happens, you must restore the database from your backup copy.
- 

**Interaction Server Database**

1. Install Interaction Server 7.2.
2. Go to the directory containing your Interaction Server. Normally this is something like `C:\GCTI\Interaction Server\<application_object_name>`.
3. In the `Script` directory, open the directory named for your database management system (Db2, MsSQL, or Oracle).
4. Run the script `isdb_<dbms_name>_7.1-7.2.sql`.

**7.2 to 7.5****UCS Database**

1. Make a backup copy of your UCS 7.2 database.
2. Install UCS 7.5.
3. Go to the directory containing your UCS 7.5. Normally this is something like `C:\GCTI\Universal Contact Server\<application_object_name>`.
4. In the `sql_scripts` directory, open the directory named for your database management system.
5. Run the script `upgrade_<dbms_name>_7.2_to_7.5.sql`.

---

**Warning!** If you attempt to start the script while an instance of it is still in progress, DB2 databases can be damaged. If this happens, you must restore the database from your backup copy. (This scenario has no effect on Oracle and MS-SQL databases).

---

Be aware of the following:

- Genesys recommends that you run the upgrade script only once on the database. If you run the script a second time, the database will not be modified but some errors will display.
- Upgrading the UCS database from 7.2 to 7.5 adds a new column (Header) to the table EmailIn. Because of this, starting UCS for the first time after the upgrade with a large database can take several minutes while UCS fills in the new column.

### Interaction Server Database

1. Make a backup copy of the Interaction Server database.
2. Install Interaction Server 7.5.
3. Go to the directory containing your Interaction Server. Normally this is something like C:\GCTI\Interaction Server\- 4. In the Script directory, open the directory named for your database management system (Db2, MSSQL, or Oracle).
- 5. Run the script isdb\_<dbms\_name>\_7.2-7.5.sql.

## 7.5 to 7.6.0

### UCS Database

1. Make a backup copy of your UCS 7.5 database.
2. Install UCS 7.6.0.
3. Go to the directory containing your UCS 7.6.0. Normally this is something like C:\GCTI\Universal Contact Server\- 4. In the sql\_scripts directory, open the directory named for your database management system.
- 5. The next step varies depending on the RDBMS:
  - For MSSQL and Oracle, run the script upgrade\_<dbms\_name>\_7.5\_to\_7.6.sql
  - For DB2, run the shell script upgrade\_db2\_7.5\_to\_7.6.sh. You must run this script from an environment properly configured for running the DB2 command line processor.

### Interaction Server Database

There is no change in the Interaction Server database schema from 7.5 to 7.6.0.

## 7.6.0 to 7.6.1

### UCS Database

1. Make a backup copy of your UCS 7.6.0 database.

2. Install UCS 7.6.1.
3. Go to the directory containing your UCS 7.6.1. Normally this is something like `C:\GCTI\Universal Contact Server\<application_object_name>`.
4. In the `sql_scripts` directory, open the directory named for your database management system.
5. The next step varies depending on the RDBMS:
  - For MSSQL and Oracle, run the script `upgrade_<dbms_name>_7.6_to_7.6.1.sql`
  - For DB2, run the shell script `upgrade_db2_7.6_to_7.6.1.sh`. You must run this script from an environment properly configured for running the DB2 command line processor.

**IDN Conversion** If the UCS `convert-idn-to-unicode` option is set to `true`, enabling support of internationalized domain names (IDN), UCS 7.6.1 performs the following conversion the first time it runs:

- Searches for contacts having the IDN escape sequence in one of their e-mail addresses
- For each such contact, converts IDN coded domain names to Unicode.
- Saves the updated contact
- Registers (in its dedicated `SystemProperties` table), that IDN conversion has been performed.

---

**Note:** A UCS in a backup configuration must have the same value for `convert-idn-to-unicode` as the primary UCS. In fact, a backup UCS will not start unless all of its option settings are identical to those of the primary.

---

If you later change the setting of `convert-idn-to-unicode` to `false`, UCS performs the reverse conversion on its next startup, converting Unicode domain names to IDN encoded.

### Interaction Server Database

1. Make a backup copy of the Interaction Server database.
2. Install Interaction Server 7.6.1.
3. Go to the directory containing your Interaction Server. Normally this is something like `C:\GCTI\Interaction Server\<application_object_name>`.
4. In the `Script` directory, open the directory named for your database management system (Db2, MsSQL, or Oracle).
5. Run the script `isdb_<dbms_name>_7.6-7.6.1.sql`.

If you want to use the Event Logger functionality of Interaction Server, new in release 7.6.1, you can also run the `elldb_<database_name>.sql` script. For details see the “Event Logger” section in the “Interaction Server: Advanced

Topics” section of the “Ongoing Administration and Other Topics” chapter of the *Multimedia 7.6 User’s Guide*.

### Database-Related Configuration Objects

Two changes in the Interaction Server database may require modifications in some Business Attribute configuration objects.

- Prior to release 7.6.1, the Interaction Server database included fields for customizable properties called `CustomString<n>`, where `n` was numbers 1–6, and `CustomNumber<n>`, where `n` was numbers 1–3. These fields do not exist in the 7.6.1 database. If you made use of any of these fields in your pre-7.6.1 configuration, you must perform the following conversion:
  - a. Create a new field in the `interactions` database table.
  - b. In Configuration Manager, locate the `InteractionCustomProperties` Business Attribute and open its `Attribute Value` that corresponds to your old custom property.
  - c. Change the `Attribute Value`'s name so that it matches the attached data key that is the source of the content of your custom property.
  - d. On the `Annex` tab, `translation` section, edit the value of the `translate-to` option so that it matches the name of the field that you created in Step a.
- In 7.6.1, certain properties that were previously stored as separate database fields are stored in the `flexible_properties` field. This means that they can no longer be used on the `Condition`, `Order`, or `Segmentation` tabs of Views. The properties are:
  - `CaseId`
  - `CategoryId`
  - `ContactId`
  - `CustomerSegment`
  - `DispositionCode`
  - `FromAddress`
  - `FromPersonal`
  - `Mailbox`
  - `ReasonCode`
  - `ServiceType`
  - `Subject`

If you want to continue to use one of these properties in this way, you must create a custom property corresponding to it, as described in the following two sections of the “Interaction Properties” chapter of the *Multimedia 7.6 User’s Guide*: “Business Properties Not Stored as Independent Fields” and “Flexible Configuration of Custom Properties.”

## Knowledge Management Spell Checking Dictionaries

To preserve any customized spell checking dictionaries when migrating, see “Language and Dictionary Names” in the Genesys Knowledge Management: Basics” chapter of the *Multimedia 7.6 User’s Guide*

## 7.6.1 to 8.0

### UCS Database

1. Make a backup copy of your UCS 7.6.0 database.
2. Install UCS 8.0.
3. Go to the directory containing your UCS 8.0. Normally this is something like C:\GCTI\Universal Contact Server\.
4. In the `sql_scripts` directory, open the directory named for your database management system.
5. The next step varies depending on the RDBMS:
  - For MSSQL and Oracle, run the script `upgrade_<dbms_name>_7.6.1_to_8.0.sql`
  - For DB2, run the shell script `upgrade_db2_7.6.1_to_8.0.sh`. You must run this script from an environment properly configured for running the DB2 command line processor.

### Interaction Server Database

There is no change in the Interaction Server database between 7.6.1 and 8.0.

## Web Portal

*Web Portal* here means Web API Server and whatever web content you have created based on the Web Compound Samples.

### 7.0 to 7.1

Your MCR 7.0 web application and Web API Server will work with MCR 7.1 components. You only need to upgrade to Web API Server 7.1 if you want your web application to use functionalities (such as voice callback and web forms) that are new in MCR 7.1.

### 7.1 to 7.2

Your MCR 7.1 web application and Web API Server will work with Multimedia 7.2 components. You only need to upgrade to Web API Server 7.2 if you want your web application to use functionalities that are new in MCR 7.2, such as web collaboration.

### 7.2 to 7.5

Your Multimedia 7.2 web application and Web API Server will work with Multimedia 7.5 components.

### 7.5 to 7.6

Your Multimedia 7.5 web application and Web API Server will work with Multimedia 7.6 components, except for the limitations described in Table 154 on [page 891](#).

### 7.6.1 to 8.0

Your Multimedia 7.6.1 web application and Web API Server will work with Multimedia 8.0 components.

## Other Data and Objects

1. Migrate or configure any data that is specific to your solution, such as agent capacity rules.
2. If you have Genesys Content Analyzer, you must convert all stop word files to UTF-8 format (prior to release 7.6, stop word files were in ANSI format). These files are located in the root directories of Knowledge Manager and Training Server. To convert one, open it with a text editor and save as UTF-8. For example, in Microsoft Notepad, select UTF-8 in the Encoding field of the Save As dialog box.

For more description of stop word files, see the “Notes on Language” section in the “Genesys Knowledge Management: Content Analysis” chapter of the *Multimedia 7.6 User’s Guide*.

3. Migrate routing strategies. For details see [Universal Routing Migration Procedures, page 615](#).

---

**Note:** Strategy objects may contain Application object names (for example, the `Classify` object can specify a Classification Server). If your new installation uses different names for any such Applications, you must update the strategies to use these new names.

---

4. Migrate Agent and/or Supervisor Desktop if you are not already using the new versions.

---

**Note:** Consult Professional Services regarding migration of any and all customized Genesys products.

---

5. Migrate Reporting templates for your new solution.





**Part**

# 18

## **Genesys Voice Platform 7.x Migration**

The chapters in this section show the migration process from previous releases to release 7.6 of Genesys Voice Platform (GVP).

This Part contains the following chapters:

- Chapter 54, “Upgrading to Genesys Voice Platform 7.6,” on page 927 discusses the migration procedures and the migration order for migrating from Voice Web Application Platform (VWAP) 6.5.x, GVP 7.0.3, 7.2.x, and 7.5 to GVP 7.6.
- Chapter 55, “Upgrading to Genesys Voice Platform 7.5,” on page 951 discusses the migration procedures and the migration order for migrating from Voice Web Application Platform (VWAP) 6.5.4, GVP 7.0.3 and 7.2 to GVP 7.5.
- Chapter 56, “Migration for Genesys Voice Platform: Network Edition,” on page 989 discusses the migration procedures and the migration order for migrating from Voice Web Application Platform (VWAP) 6.5.4 and 7.0.3 to GVP: NE 7.2.
- Chapter 57, “Migration for Genesys Voice Platform: Enterprise Edition,” on page 1009 discusses the migration procedures and the migration order for migrating from GVP: EE 6.5.5 and 7.0.3 to GVP: EE 7.2.
- Chapter 58, “Migration for Genesys Voice Platform: Developer’s Edition,” on page 1025 discusses the migration procedures and the migration order for migrating from GVP: DE 6.5.4 and 7.0.3 to GVP: DE 7.2.
- Chapter 59, “Migration for Genesys Voice Platform: Studio,” on page 1029 discusses the migration procedures and the migration order for migrating from GVP: Studio 6.5.5, 7.0.3, 7.2, and 7.5.
- Chapter 60, “Migration for Genesys Voice Platform: VAR,” on page 1043 discusses the migration procedures and the migration order for migrating from GVP: Voice Application Reporter 6.5.5, 7.0.3, 7.2, and 7.5.





## Chapter

# 54

## Upgrading to Genesys Voice Platform 7.6

This chapter discusses the procedures and order for migrating data and upgrading software to Genesys Voice Platform (GVP) 7.6.

---

**Note:** The conventions used in this chapter are:

- *Upgrade*—refers to replacing previous versions of GVP software with GVP 7.6 software.
- *Migrate*—refers to migrating Voice Portal Manager (VPM) data from Genesys Voice Platform: Enterprise Edition (GVP: EE) or migrating Element Management Provisioning System (EMPS) data from Genesys Voice Platform: Network Edition (GVP: NE) to the 7.6 EMPS.

---

This chapter includes the following sections:

- [GVP 7.5 to GVP 7.6, page 927](#)
- [GVP 7.2.x to GVP 7.6, page 934](#)
- [GVP 7.0.3 to GVP 7.6, page 949](#)
- [GVP 6.5.x to GVP 7.6, page 949](#)

---

## GVP 7.5 to GVP 7.6

- Mixed Mode** A mixed-mode operation is possible. Some hosts can be running GVP 7.5 software, other hosts can be running GVP 7.6. However all components on one host or guest OS when using VMware must be running the same version.
- Scenarios** You do not need to follow a specific sequence for upgrading various components. However, two common scenarios are described:
- You want to upgrade all GVP components from 7.5 to 7.6.

- You want to upgrade only selected GVP components from 7.5 to 7.6.

Slightly different approaches are suggested for these two scenarios to make the best use of the available tools and to ease the upgrade process.

**In-Service Upgrade**

Use the following strategy for *in-service* upgrade, which is upgrading to 7.6 while calls are still being processed:

- Upgrade one host at a time.
- Perform the upgrade during lean call periods for incoming calls.
- Make sure that there are redundant hosts (primary and backup) for each component, except EMPS.
- Upgrade the backup host first. Ensure that the upgraded backup host works by changing profiles to direct a small fraction of the calls to the backup host, and then upgrade the primary host. This does not apply to EMPS, VCS, or IPCS.
- Start by upgrading EMPS, and then upgrade EMS Runtime components, Reporting, IPCM, and IPCS/VCS in that order.

Use the instructions: “Scenario 2: Upgrade Only Selected Components” on [page 930](#).

## Scenario 1: Upgrade All Components

### Step 1—Stop Making Provisioning Changes

Do not provision new applications or change server configurations until the migration is complete or unless required as an explicit step during migration.

### Step 2—Load the New Management Information Bases (MIBs)

---

**Note:** If no Network Management System (NMS) is deployed, these steps do not apply.

---

1. If you are using an NMS that receives Simple Network Management Protocol (SNMP) traps from GVP, load the 7.6 GVP MIBs into the NMS before installing any GVP components.
2. If pre-GVP 7.6 MIBs exist on the NMS, overwrite them with the GVP 7.6 MIBs.
3. Check your NMS user guide for instructions about loading the MIBs.  
Loading new MIBs ensures that any traps generated by the new GVP 7.6 are represented in your NMS. Refer to the *Genesys Voice Platform 7.6 Deployment Guide* for instructions on how to extract GVP 7.6 MIBs.

### Step 3—Install EMPS 7.6 on Existing EMPS 7.5 Host

1. Stop WatchDog and uninstall all GVP components on the EMPS host by using Add/Remove Programs from the Control Panel.
2. Install GDA from the GVP 7.6 Base DVDs installation folder.
3. Using the GDT, install EMPS 7.6. Refer to the *Genesys Voice Platform 7.6 Deployment Guide* for details. Select the Upgrade to GVP 7.6 option, and then select the Install EMPS and upgrade option to achieve this step. Make sure that you use the same tenancy option (Single Tenancy or Multi-Tenancy) as previously used.
4. From the SQL Query Analyzer, run the script `EMPS_DB_NEW_76_SQLServer.sql` against the EMPS catalog to update the schema for EMPS Reporting.

---

**Note:** You do not need to run the DMT to migrate configuration data from 7.5 to 7.6 because there is no schema change in LDAP. The only change required is to replace the `McuXml` node with the `Mcu` node, which is achieved by the IPCS setup executable.

---

### Step 4—Upgrade all Other Hosts

1. Upgrade the GDA to version 7.6 on the target hosts:
  - a. Start GVP 7.6 GDT on the host that was used to deploy GVP 7.5 software.
  - b. In the GDT Wizard, click `Cancel`.
  - c. In the main GDT menu, select `Deploy > Maintenance > GDA Upgrade`.
  - d. Specify the software location by browsing to the appropriate GVP 7.6 DVD images.
  - e. Click `Next`.

GDT copies the GVP 7.6 DVD software to `C:\GDT\Media` by overwriting the version 7.5 folders. This will take a few minutes because it also zips the software. When it is finished, GDT asks you to select the servers for the selected operation (GDA upgrade).
  - f. Add the target host servers to move them to the right window, and then click `Next`.

GDT transfers the base DVD software to the target hosts and upgrades the GDA on the target host to version 7.6. When the upgrade is completed, click `Finish`, and then exit the GDT main window.
2. Re-launch GDT 7.6.

GDT connects to the 7.5 EMPS and displays all of the configured servers in the main window.
3. In the GDT Wizard, select the Upgrade to GVP 7.6 radio button. On the next screen, select Use Existing EMPS to upgrade.

The Overview screen displays the GVP Upgrade Task List. Follow the instructions on the screen and select the check box if GDA was installed and running on all servers on which GVP software will be installed.

4. The Specify Setup Type screen prompts you to select the setup type (IP/TDM Telephony).
  - a. Verify that the settings are the same settings used in GVP 7.5. Do not change the settings after verifying.
  - b. On the Copy Software screen, specify the software location for the GVP 7.6 DVD images.

GDT re-copies all of the base software DVD to C:\GDT\Media.

The EMPS Connection Settings screen asks you to enter information about EMPS. Do not change the pre-filled information.

Click Next.

The Migrate EMPS Data screen appears.

5. Select the check box I have migrated the data to new EMPS 7.6, even though you did not migrate any data using DMT. Click Next.

The Upgrade GVP Servers screen appears. This screen finds the GVP servers in the network that can be upgraded. The main GDT window should now show the current versions and the new versions of the GVP software that have been copied.

6. Select the target hosts and click Add to move them in the right window. Click Next.

This starts the process of transferring the software to the target hosts and then upgrading to release 7.6:

- a. The GDT uninstalls all components on the target hosts.
- b. The GDT installs release 7.6 of the components. No reconfiguration is performed.

When the upgrade is complete, the status will be updated in the Wizard and in the GDT main window.

- c. Click Finish in the GDT Wizard.

---

**Note:** You do not need to run any MSSQL scripts on the Reporting Servers' Databases to upgrade tables for Collector, Reporter, and so on, because the schemas have not changed from GVP 7.5.

---

## Scenario 2: Upgrade Only Selected Components

### IPCS Host Only

1. Save the ASR and TTS MRCP Server Groups information:
  - a. Log in to EMPS.

- b. Go to the target host under IPCS.
  - c. Go to the node `McuXml > ASR > MRCP`. From the servers selection for the primary and backup ASR MRCP server groups, write down the selected Server groups on a piece of paper.
  - d. Go to the node `TTS_MRCP > TTS > MRCP`. From the servers selection for the primary and backup TTS MRCP server groups, write down the selected Server groups on a piece of paper.
2. Change (or add) the `minaudioidsize` parameter in `TTS_MRCP` to 8192.
3. Change the `TTS_MRCP` server streaming to `realtime`.
4. Initiate a graceful shutdown of WatchDog on the target host. If calls are stuck and shutdown has not occurred, you can initiate an ungraceful shutdown.
5. Upgrade the GDA to version 7.6 on the target host (IPCS):
  - a. Using the GDT, copy the GVP 7.6 Base DVD image to the hard drive on the system from where GVP 7.5 was deployed.
  - b. In the DVD image on the hard drive, go to the `solution_specific\windows\install` folder and double-click `GVPLaunch.bat` to run GDT.
  - c. In the GDT wizard, select `Cancel`.
  - d. In the main GDT menu, select `Deploy > Maintenance > GDA Upgrade`. Specify the software location by browsing to the `solution_specific\windows` in the GVP 7.6 Base DVD image.
  - e. Click `Next`.  
GDT copies the GVP 7.6 Base DVD software to `C:\GDT\Media` by overwriting the version 7.5 folders. This will take a few minutes, because it is also zipping the software. When it is complete, GDT asks you to select the servers for the selected operation (GDA upgrade).
  - f. Add the target host server to move it to the right window, and then click `Next`.  
GDT transfers the base DVD software to the target host, and then upgrades the GDA on the target host to release 7.6.
  - g. Once the upgrade is complete, click `Finish`, and then exit the GDT main window.
6. Re-launch GDT 7.6 from the `solution_specific\windows\install` folder. GDT connects to the 7.5 EMPS and displays all of the configured servers in the main window.
  - a. In the GDT Wizard, select the `Upgrade to GVP 7.6` radio button. On the next screen, select `Use Existing EMPS to upgrade`.
  - b. Ignore the text that says this option is used to Upgrade using the existing EMPS (7.6 version) which has the migrated data because you are running with EMPS (7.5 version).

- c. The Overview screen displays the GVP Upgrade Task List. Follow the instructions on this screen and select the check box if GDA was installed and running on all servers on which GVP software will be installed.
7. The Specify Setup Type screen prompts you to select the setup type (IP/TDM Telephony).

Do not change the settings after verifying that these are the same settings you used for GVP 7.5.

On the Copy Software screen, specify the software location for the GVP 7.6 Base DVD image only by browsing to the `solution_specific\windows` folder.

Do not change the other DVD locations; they still point to the GVP 7.5 DVD images. The GDT re-copies all of the base software DVD to `C:\GDT\Media`.

The EMPS Connection Settings screen prompts you to enter information about EMPS. Do not change the pre-filled information.

8. Click Next.
9. The Migrate EMPS Data screen has a checkbox that says I have migrated the data to new EMPS 7.6. Select this check box even though you have not upgraded EMPS or migrated any data. This is necessary if you are performing a complete migration (including EMPS) from 7.5 or earlier versions.
10. Click Next.

The Upgrade GVP Servers screen appears. This screen finds the GVP servers in the network that can be upgraded. The main GDT window should now show the current versions and the new versions of the GVP software that have been copied. Select the target hosts and click Add to move them in the right window. Click Next.

This starts the process of transferring the software to the target hosts and then upgrading to release 7.6:

- a. The GDT uninstalls all components on the target hosts.
- b. The GDT installs release 7.6 of the components. No reconfiguration is performed.

When the upgrade is complete, the status will be updated in the Wizard and in the GDT main window.

- c. Click Finish in the GDT Wizard.
  - d. You do not need to run any MSSQL scripts on the Reporting Servers' Databases to upgrade tables for Collector, Reporter, and so on, because the schemas have not changed from GVP 7.5.
11. Click Finish in the GDT Wizard.

TTS will not be upgraded for IPCS because it is not needed as a separate process in GVP 7.6, and it is now part of the Mcu process.



For the IPCS host, you must manually move the information from the McuXML node to the MCU node in EMPS:

1. Log in to EMPS.
2. Go to the target host under IPCS.
3. Go to Mcu > ASR > MRCP. In the Servers selection for the Primary and Backup ASR MRCP Server Groups, select the same server groups as previously existed in the McuXML node (which no longer exists). This information was saved in [Step 1](#) for upgrading IPCS hosts.
4. Go to Mcu > TTS > MRCP. In the Servers selection for the Primary and Backup TTS MRCP Server Groups, select the same server groups as previously existed in the TTS\_MRCP node (which no longer exists). This information was saved in [Step 1](#) for upgrading IPCS hosts.

### VCS Host Only

1. Upgrade the Dialogic software to the latest version for GVP 7.6 by uninstalling the older Dialogic software, and then installing the Dialogic software using the GVP 7.6 Dialogic SR 6.0 DVD.
2. Follow [Step 4](#) through [Step 11](#) in the section “IPCS Host Only” on [page 930](#).

### IPCM Host Only

- ♦ Follow [Step 4](#) through [Step 11](#) in the section “IPCS Host Only” on [page 930](#). Instead of specifying the Base DVD image location, specify the location for the SIP Call Manager or H.323 Call Manager DVD image.

### EMS Run Time Host Only

- ♦ Follow [Step 4](#) through [Step 11](#) in the section “IPCS Host Only” on [page 930](#).

### Reporting Server Host Only

- ♦ Follow [Step 4](#) through [Step 11](#) in the section “IPCS Host Only” on [page 930](#). Instead of specifying Base DVD image location, specify the location for the Reporting and Monitoring DVD image.

---

**Note:** You do not need to run any MSSQL scripts on the Reporting Servers’ Databases to upgrade tables for Collector, Reporter, and so on, because the schemas have not changed from GVP 7.5.

---

### EMPS Host Only

1. Stop WatchDog and uninstall all GVP components on the EMPS host by using Add/Remove Programs from the Control Panel.

2. Install GDA from the GVP 7.6 Base DVDs installation folder.
3. Using the GDT, install EMPS 7.6. Refer to the *Genesys Voice Platform 7.6 Deployment Guide* for details. Select the Upgrade to GVP 7.6 option, and then select the Install EMPS and upgrade option to achieve this step. Make sure that you use the same tenancy option (Single Tenancy or Multi-Tenancy) as previously used.
4. From the SQL Query Analyzer, run the script `EMPS_DB_NEW_76_SQLServer.sql` against the EMPS catalog to update the schema for EMPS Reporting.

---

**Note:** You do not need to run the DMT to migrate configuration data from 7.5 to 7.6 because there is no schema change in LDAP. The only change required is to replace the `McuXML` node with the `Mcu` node, and that is achieved by the IPCS setup executable.

---

### Hosts with Components not Installed Using GDT

1. Uninstall all GVP components on the hosts by using Add/Remove Programs from the Control Panel.
2. Install the new components from the GVP 7.6 DVDs by running the setup executable file for each component.

---

**Note:** You do not need to reconfigure the components in EMPS because the configuration information is already stored in the EMPS (7.5) LDAP database.

---

## GVP 7.2.x to GVP 7.6

|                                     |                                                                                                                                                                                                                                                          |
|-------------------------------------|----------------------------------------------------------------------------------------------------------------------------------------------------------------------------------------------------------------------------------------------------------|
| <b>Installation Sequence</b>        | GVP 7.6 EMPS installation is always performed first, followed by data migration, and then the software upgrade.                                                                                                                                          |
| <b>Direct Migration and Upgrade</b> | You can migrate/upgrade directly from GVP 7.2.x to GVP 7.6. You do not need to first migrate/upgrade to GVP 7.5                                                                                                                                          |
| <b>In-Service Upgrade</b>           | In-service upgrade is supported where calls can continue to be processed while different hosts are upgraded from 7.2.x to 7.6. You must have backup EMS Runtime components configured in the 7.2.x network. Perform the upgrade during off-peak periods. |
| <b>Mixed Mode</b>                   | During the upgrade and migration, some hosts in the GVP network can run release 7.2.x and other hosts can run release 7.6. However, Genesys does not recommend mixed-mode for long-term operation.                                                       |
| <b>GVP Common</b>                   | You must upgrade all GVP components on one host at the same time because the GVP components must use the same release of GVP Common.                                                                                                                     |

## GVP: EE 7.2.x to GVP 7.6

### Strategy Overview

- GVP 7.6 only supports Windows 2003. Make sure that you have upgraded your 7.2.x host operating systems to Windows 2003 before starting the migration.
- Using the DMT, migrate the provisioning data from release 7.2.x Voice Portal Manager (VPM) to release 7.6 Element Management Provisioning System (EMPS). You can install EMPS 7.6 on a new server or on the existing VPM server provided that 7.2.x Common is not installed on the VPM server.
- The Data Migration Tool in EMPS has a Server Mapping feature that can help you move existing customer/application data to a new network. It provides a mapping capability by which old server names can be mapped to new server names, and the data transformation will also change the server names, where applicable. You should use this feature to preserve the configuration of the GVP 7.2.x servers while installing the GVP 7.6 software on new Windows 2003 servers.

#### Important

The source server and target server in the Server Mapping window must have the same combination of components. For example, if the source server has IPCS, PM, and BWM, the target server must only have IPCS, PM, and BWM.

- Make sure you have a properly functioning GVP 7.2.x network before proceeding with the migration. Do not debug existing 7.2.x configurations and migrate to 7.6 at the same time.
- To ensure that you can take calls while the network is being upgraded, use the following sequence:
  - Stop making provisioning changes and back up the provisioning data.
  - Install EMPS 7.6, and using the DMT, migrate the data from the old provisioning system.
  - Upgrade the backup IPCM (SSM/H.323 and RM).
  - Upgrade the primary IPCM (SSM/H.323 and RM).
  - Upgrade the VCS/IPCS hosts.

### Procedure

#### Step 1—Back up the Voice Portal Manager (VPM) Database

1. Make sure that you back up existing configuration information. This facilitates reconfiguration after upgrading and in case you must roll-back the upgrade. You can do this by making a copy of the `cn_vpm` folder and storing it as a backup.

2. Do not provision new applications or change server configurations until the migration is complete or unless required as an explicit step during migration.

### Step 2—Load the New Management Information Bases (MIBs)

---

**Note:** If no Network Management System (NMS) is deployed, these steps do not apply.

---

1. If you are using an NMS that receives Simple Network Management Protocol (SNMP) traps from GVP, load the 7.6 GVP MIBs into the NMS before installing any GVP components.
2. If pre-GVP 7.6 MIBs exist on the NMS, overwrite them with the GVP 7.6 MIBs.
3. Check your NMS user guide for instructions about loading the MIBs. Loading new MIBs ensures that any traps generated by the new GVP 7.6 are represented in your NMS. Refer to the *Genesys Voice Platform 7.6 Deployment Guide* for instructions on how to extract GVP 7.6 MIBs.

### Step 3—Install EMPS 7.6

1. Using the GDT, install EMPS 7.6. You can install it on the same server as VPM, as long as no other GVP 7.2.x components are installed on that server. Refer to the *Genesys Voice Platform 7.6 Deployment Guide* for details.
2. Select the Upgrade to GVP 7.6 option, and then select the Install EMPS and upgrade option to achieve this step. Make sure that you select the Single Tenancy option.

### Step 4—Migrate Data from VPM to EMPS 7.6 Using the DMT

1. To launch DMT on the EMPS 7.6 server, double-click the file `<install directory>DMT\bin\run_dmt.bat`.  
The Welcome to the GVP Data Migration Tool screen appears.
2. Click Next.  
The Version Selection screen appears.
3. Select the source installation type.
4. Select VPM and version (7.2.x) from the drop-down list. Click Next.  
The VPM Source Configuration screen appears.
5. Click Browse to select the VPM installation path if installing on the same host. This can also be a copy of the `cn_vpm` folder. If running the DMT from a server that is different from the VPM, the path to the `cn_vpm` folder can be a mapped drive. Click Next.

The `EMPS Destination Configuration` screen appears.

6. In the `EMPS Host` text box, enter the Fully Qualified Domain Name (FQDN) of the EMPS 7.6 host. The user name of `admin` is already entered. In the `Password` text box, enter the login password for EMPS 7.6 (typically the word `password`). Click `Next`.

The `Migration Options` screen appears.

7. From the list of configuration elements, select the elements to migrate:
  - `Resellers/Customer/Application Data`
  - `Servers`

The executable file `SCAImport.exe` migrates the data. If the executable cannot be found in the default path, a message appears, and the DMT prompts for the location of the file.

Click `Browse for SCAImport` and select `<EMPS install directory>\bin\SCA.exe`.

Click `Next`.

The `Dispenser Information` screen appears.

8. In the `Dispenser Host` text box, enter the FQDN of the Dispenser host. In the `Dispenser Port` text box, enter the port of the Dispenser host if it is different from the default of `80`. Click `Next`.

The `Confirm Settings` screen appears.

9. Review the selections. Click `Back` if you need to make changes. Click `Next`. The `Start` button appears.

10. Click `Start`.

11. When the data migration is complete, click `Finish`.

After data migration, the EMPS will not reflect the correct format of the field names. All of the migrated field names in EMPS will be preceded with an exclamation mark (!) because the 7.6 template has not yet been assigned to the specific server. Once the software upgrade is complete and the 7.6 templates are assigned, the EMPS field names appear as expected.

Although the GDT configures most parameters, you are responsible for ensuring that specific servers are configured correctly after upgrading. For example, if you want to use a different Dispenser, you must correct the Dispenser address.

### Step 5—Upgrade the Backup IPCM Host

In-service upgrade requires a backup IPCM host.

If you do not have a backup IPCM host and you do not want in-service upgrade, you can skip this step.

If you do not have a backup IPCM host and you want in-service upgrade, you must first install and configure a backup IPCM host by following the instructions in the *Genesys Voice Platform 7.2 Deployment Guide*.

Continue with the GDT to upgrade other servers, starting with the IPCM backup host. If you exited the GDT, you can invoke it again and select the Upgrade to GVP 7.6 radio button. On the next screen, select Use Existing EMPS to upgrade.

1. Initiate a graceful shutdown of WatchDog on the backup IPCM. If calls are stuck and shutdown has not occurred, you can initiate an ungraceful shutdown.
2. Install GDA on the target host as detailed in the *Genesys Voice Platform 7.6 Deployment Guide*.
3. Using the GDT, install GVP 7.6 Resource Manager (RM) and GVP 7.6 SIP Session Manager/H.323 Session Manager (SSM/HSM).

The Upgrade GVP Servers screen locates the GVP servers in the network that can be upgraded. The main GDT window should now show the current versions and the new versions of the GVP software that have been copied.

4. Select the IPCM (backup) target host and click Add to move it in the right window. Click Next. This starts the process of transferring the software to the target host and then upgrading to release 7.6.
5. Click Finish when the upgrade is complete.

---

**Note:** A message may appear during the uninstallation of SSM that states TlraSessionMgr error - Application error while referencing memory at 0x000000. You can ignore this error, but do not click OK until the upgrade is complete.

---

6. Restart WatchDog on the IPCM. Restart all IPCSs in the network to register them with the backup IPCM.
7. Move five percent of the existing call traffic to the backup IPCM, and then monitor the system. If there are no issues, slowly increase the call traffic to 100 percent. If calls are not being processed correctly by the backup IPCM, restore the original configuration and contact Genesys Technical Support.

### Step 6—Upgrade the Primary IPCM Host

Continue with the GDT to upgrade the primary IPCM host. If you exited the GDT, you can invoke it again and select the Upgrade to GVP 7.6 radio button. On the next screen, select Use Existing EMPS to upgrade.

1. Initiate a graceful shutdown of WatchDog on the primary IPCM. If calls are stuck and shutdown has not occurred, you can initiate an ungraceful shutdown.
2. Install GDA on the target host as detailed in the *Genesys Voice Platform 7.6 Deployment Guide*.
3. Using the GDT, install GVP 7.6 Resource Manager (RM) and GVP 7.6 SIP Session Manager/H.323 Session Manager (SSM/HSM).

The Upgrade GVP Servers screen locates the GVP servers in the network that can be upgraded. The main GDT window should now show the current versions and the new versions of the GVP software that have been copied.

4. Select the IPCM (primary) target host and click Add to move it in the right window. Click Next.

This starts the process of transferring the software to the target host and then upgrading to release 7.6.

5. Click Finish when the upgrade is complete.

---

**Note:** A message may appear during the uninstallation of SSM that states `TlraSessionMgr error - Application error while referencing memory at 0x000000`. You can ignore this error, but do not click OK until the upgrade is complete.

---

6. Restart WatchDog on the IPCM. Restart all IPCSs in the network to register them with the primary IPCM.
7. Move five percent of the existing call traffic to the primary IPCM, and then monitor the system. If there are no issues, slowly increase the call traffic to 100 percent. If calls are not being processed correctly by the primary IPCM, restore the original configuration and contact Genesys Technical Support.

### Step 7—Upgrade the IPCS/VCS Host(s)

Continue with the GDT to upgrade the VCS/IPCS hosts one at a time. If upgrading a VCS, first upgrade the Dialogic software to the latest version for GVP 7.6 by uninstalling the older Dialogic software, and then installing the Dialogic software using the GVP 7.6 Dialogic SR 6.0 DVD.

1. Initiate a graceful shutdown of WatchDog on the VCS/IPCS. If calls are stuck and shutdown has not occurred, you can initiate an ungraceful shutdown.
2. Install GDA on the target host as detailed in the *Genesys Voice Platform 7.6 Deployment Guide*.

3. Using the GDT, upgrade the software on the target host to release 7.6.

The Upgrade GVP Servers screen locates the GVP servers in the network that can be upgraded. The main GDT window should now show the current versions and the new versions of the GVP software that have been copied.

4. Select the target host and click Add to move it in the right window. Click Next.

This starts the process of transferring the software to the target host and then upgrading to release 7.6.

5. Click Finish when the upgrade is complete.

6. Restart WatchDog and move five percent of the existing call traffic to the upgraded VCS/IPCS, and then monitor the system. If there are no issues, slowly increase the call traffic. If calls are not being processed correctly by the VCS/IPCS, restore the original configuration and contact Genesys Technical Support.

---

**Notes:** TTS will not be upgraded for IPCS because it is not needed as a separate process in GVP 7.6, and it is now part of the Mcu process.

The IPCS in release 7.6 uses an Mcu process instead of the McuXml and TTS\_MRCP processes used in GVP 7.2.x. As each IPCS server is upgraded, in EMPS, under the node corresponding to that server, the McuXml node and the TTS\_MRCP node disappear and an Mcu node with ASR > MRCP and ASR > TTS subnodes appears.

---

### Step 8—Upgrade Hosts with Components that Cannot be Installed Using GDT

1. Uninstall all GVP 7.2.x components on the host using Add/Remove Programs from the Control Panel.
2. Install the new components from the GVP 7.6 DVDs by running the setup executable file for each component.

You do not need to reconfigure the components in EMPS because the configuration information is already stored in the migrated EMPS 7.6 LDAP database.

## GVP: NE 7.2.x to GVP 7.6

### Strategy Overview

- GVP 7.6 only supports Windows 2003. Make sure that you have upgraded your 7.2.x host operating systems to Windows 2003 before starting the migration.
- You cannot upgrade EMPS from release 7.2.x to 7.6 because the provisioning system has completely changed in release 7.6. You must use a new host to install GVP 7.6 EMPS. Using the DMT, migrate the provisioning data from release 7.2.x to release 7.6.
- The Data Migration Tool in EMPS has a Server Mapping feature that can help you move existing customer/application data to a new network. It provides a mapping capability by which old server names can be mapped to new server names, and the data transformation will also change the server names, where applicable. You should use this feature to preserve the configuration of the GVP 7.2.x servers while installing the GVP 7.6 software on new Windows 2003 servers.



**Important**

The source server and target server in the Server Mapping window must have the same combination of components. For example, if the source server has IPCS, PM, and BWM, the target server must only have IPCS, PM, and BWM.

- Make sure that you have a properly functioning GVP 7.2.x network before proceeding with the migration/upgrade. Do not debug existing 7.2.x configurations and migrate to 7.6 at the same time.
- To ensure that you can take calls while the network is being upgraded, use the following sequence:
  - Stop making provisioning changes.
  - Install EMPS 7.6 on a new host, and, using the DMT, migrate the data from the old provisioning system.
  - Upgrade the backup Runtime host(s) to GVP 7.6.
  - Upgrade the primary Runtime host(s) to GVP 7.6.
  - Upgrade the Reporting Server host(s) to GVP 7.6. Run MSSQL scripts to change reporting schema to the new versions.

---

**Note:** During the upgrade of the Reporting Server(s), the IPCSs/VCSs keep the call events data on their local disks and send the data to the upgraded Reporting Server(s) once they come back up.

---

- Upgrade IPCM (SSM/H.323 and RM).
- Upgrade the VCS/IPCS hosts last.

## Procedure

### Step 1—Do Not Make Provisioning Changes

- Do not provision new applications or change server configurations until the migration is complete or unless required as an explicit step during migration.

### Step 2—Load the New Management Information Bases (MIBs)

---

**Note:** If no Network Management System (NMS) is deployed, these steps do not apply.

---

1. If you are using an NMS that receives Simple Network Management Protocol (SNMP) traps from GVP, load the 7.6 GVP MIBs into the NMS before installing any GVP components.
2. If pre-GVP 7.6 MIBs exist on the NMS, overwrite them with the GVP 7.6 MIBs.
3. Check your NMS user guide for instructions about loading the MIBs.

Loading new MIBs ensures that any traps generated by the new GVP 7.6 are represented in your NMS. Refer to the *Genesys Voice Platform 7.6 Deployment Guide* for instructions on how to extract GVP 7.6 MIBs.

### Step 3—Install EMPS 7.6

1. Install the 7.6 GDA on the target EMPS server before starting. Specify the GVP 7.6 software location by browsing to the `solution_specific\windows` in the GVP 7.6 DVD images.
2. Using the GDT, install EMPS 7.6 a new server. Refer to the *Genesys Voice Platform 7.6 Deployment Guide* for details.
3. Select the Upgrade to GVP 7.6 option, and then select the Install EMPS and upgrade option to achieve this step. Make sure that you select the Multi Tenancy option.

### Step 4—Migrate Data from EMPS to EMPS 7.6 Using the DMT

1. To launch DMT on the EMPS 7.6 server, double-click the file `<install directory>DMT\bin\run_dmt.bat`.  
The Welcome to the GVP Data Migration Tool screen appears.
2. Click Next.  
The Version Selection screen appears.
3. Select the source installation type.
4. Select EMPS and version (7.2 MR1) from the drop down list. Click Next.  
The EMPS Source Configuration screen appears.
5. In the EMPS Host text box, enter the hostname or IP address of the source EMPS installation. Click Next.  
The EMPS Destination Configuration screen appears.
6. In the EMPS Host text box, enter the Fully Qualified Domain Name (FQDN) of the EMPS 7.6 host. The username of admin is already entered. In the Password text box, enter the login password for EMPS 7.6 (typically the word password). Click Next.  
The Migration Options screen appears.
7. From the list of configuration elements, select the elements to migrate:
  - Resellers/Customer/Application Data
  - Servers
  - Groups
  - DID Groups
  - Scheduled Tasks
  - Custom Data

The executable file `SCAImport.exe` migrates the data. If the executable cannot be found in the default path, a message appears, and the DMT prompts for the location of the file.

Click **Browse** for `SCAImport` and select `<EMPS install directory>\bin\SCA.exe`.

Click **Next**.

The **Dispenser Information** screen appears.

8. In the **Dispenser Host** text box, enter the FQDN of the Dispenser host. In the **Dispenser Port** text box, enter the port (80) of the Dispenser host. Click **Next**.

The **Confirm Settings** screen appears.

9. Review the selections. Click **Back** if you need to make changes. Click **Next**. The **Start** button appears.

10. Click **Start**.

Do not click **Cancel** at any time to stop the data migration. When the data migration is complete, click **Finish**.

After data migration, the EMPS will not reflect the correct format of the field names. All of the migrated field names in EMPS will be preceded with an exclamation mark (!) because the 7.6 template has not yet been assigned to the specific server. Once the upgrade is complete and the 7.6 templates are assigned, the EMPS field names appear as expected.

Although the GDT configures most parameters, you are responsible for ensuring that specific servers are configured correctly after upgrading. For example, if you want to use a different Dispenser, you must correct the Dispenser address.

### Step 5—Upgrade the Backup EMS Runtime Host(s)

EMS Runtime hosts are the hosts running Bandwidth Manager (BWM), Policy Manager (PM), and IVR Server Client (also known as GQA).

In-service upgrade requires a backup EMS runtime host.

If you do not have a backup EMS runtime host and you do not want in-service upgrade, you can skip this step.

Continue with the GDT to upgrade the servers, starting with the backup EMS Runtime host. If you exited the GDT, you can invoke it again and select the **Upgrade to GVP 7.6 radio** button. On the next screen, select **Use Existing EMPS to upgrade**.

1. Initiate a graceful shutdown of WatchDog on the backup EMS Runtime hosts. If calls are stuck and shutdown has not occurred, you can initiate an ungraceful shutdown.
2. Install GDA on the target host as detailed in the *Genesys Voice Platform 7.6 Deployment Guide*.
3. Using the GDT, upgrade the host with backup BWM, PM, and IVR Server Client/GQA.

The Upgrade GVP Servers screen locates the GVP servers in the network that can be upgraded. The main GDT window should now show the current versions and the new versions of the GVP software that have been copied.

4. Select the EMS Runtime (backup) target host and click Add to move it in the right window. Click Next.

This starts the process of transferring the software to the target host and then upgrading to release 7.6.

5. Click Finish when the upgrade is complete.
6. Restart WatchDog on the EMS Runtime host.
7. Regenerate the customer provisioning information for all customers by selecting Edit Customer for each customer in EMPS, and then clicking Save.
8. Restart WatchDog on the backup EMS Runtime host(s).
9. Move five percent of the existing call traffic to the backup EMS Runtime, and then monitor the system. If there are no issues, slowly increase the call traffic to 100 percent. If calls are not being processed correctly by the backup EMS Runtime, restore the original configuration and contact Genesys Technical Support.

### Step 6—Upgrade Primary EMS Runtime Host(s)

Continue with the GDT to upgrade the primary EMS Runtime hosts. If you exited the GDT, you can invoke it again and select the Upgrade to GVP 7.6 radio button. On the next screen, select Use Existing EMPS to upgrade.

1. Initiate a graceful shutdown of WatchDog on the primary EMS Runtime hosts. If calls are stuck and shutdown has not occurred, you can initiate an ungraceful shutdown.
2. Install GDA on the target host as detailed in the *Genesys Voice Platform 7.6 Deployment Guide*.
3. Using the GDT, upgrade the host with primary BWM, PM, and IVR Server Client/GQA.

The Upgrade GVP Servers screen locates the GVP servers in the network that can be upgraded. The main GDT window should now show the current versions and the new versions of the GVP software that have been copied.

4. Select the EMS Runtime (primary) target host and click Add to move it in the right window. Click Next.

This starts the process of transferring the software to the target host and then upgrading to release 7.6.

5. Click Finish when the upgrade is complete.
6. Restart WatchDog on the EMS Runtime host.

7. Regenerate the customer provisioning information for all customers by selecting `Edit Customer` for each customer in EMPS, and then clicking `Save`.
8. Restart WatchDog on the primary EMS Runtime host(s).
9. Move five percent of the existing call traffic to the backup EMS Runtime, and then monitor the system. If there are no issues, slowly increase the call traffic to 100 percent. If calls are not being processed correctly by the backup EMS Runtime, restore the original configuration and contact Genesys Technical Support.

### Step 7—Upgrade Backup IPCM Host

In-service upgrade requires a backup IPCM host.

If you do not have a backup IPCM host and you do not want in-service upgrade, you can skip this step.

If you do not have a backup IPCM host and you want in-service upgrade, you must first install and configure a backup IPCM host by following the instructions in the *Genesys Voice Platform 7.2 Deployment Guide*.

Continue with the GDT to upgrade other servers, starting with the IPCM backup host. If you exited the GDT, you can invoke it again and select the `Upgrade to GVP 7.6 radio` button. On the next screen, select `Use Existing EMPS to upgrade`.

1. Initiate a graceful shutdown of WatchDog on the backup IPCM. If calls are stuck and shutdown has not occurred, you can initiate an ungraceful shutdown.
2. Install GDA on the target host as detailed in the *Genesys Voice Platform 7.6 Deployment Guide*.
3. Using the GDT, install GVP 7.6 Resource Manager (RM) and GVP 7.6 SIP Session Manager/H.323 Session Manager (SSM/HSM).

The `Upgrade GVP Servers` screen locates the GVP servers in the network that can be upgraded. The main GDT window should now show the current versions and the new versions of the GVP software that have been copied.
4. Select the IPCM (backup) target host and click `Add` to move it in the right window. Click `Next`. This starts the process of transferring the software to the target host and then upgrading to release 7.6.
5. Click `Finish` when the upgrade is complete.

---

**Note:** A message may appear during the uninstallation of SSM that states `TlraSessionMgr error - Application error while referencing memory at 0x000000`. You can ignore this error, but do not click `OK` until the upgrade is complete.

---

6. Restart WatchDog on the IPCM. Restart all IPCSs in the network to register them with the backup IPCM.
7. Move five percent of the existing call traffic to the backup IPCM, and then monitor the system. If there are no issues, slowly increase the call traffic to 100 percent. If calls are not being processed correctly by the backup IPCM, restore the original configuration and contact Genesys Technical Support.

### Step 8—Upgrade Primary IPCM Host

Continue with the GDT to upgrade the primary IPCM host. If you exited the GDT, you can invoke it again and select the Upgrade to GVP 7.6 radio button. On the next screen, select Use Existing EMPS to upgrade.

1. Initiate a graceful shutdown of WatchDog on the primary IPCM host. If calls are stuck and shutdown has not occurred, you can initiate an ungraceful shutdown.
2. Install GDA on the target host as detailed in the *Genesys Voice Platform 7.6 Deployment Guide*.
3. Using the GDT, install GVP 7.6 Resource Manager (RM) and GVP 7.6 SIP Session Manager/H.323 Session Manager (SSM/HSM).

The Upgrade GVP Servers screen locates the GVP servers in the network that can be upgraded. The main GDT window should now show the current versions and the new versions of the GVP software that have been copied.

4. Select the IPCM (primary) target host and click Add to move it in the right window. Click Next.

This starts the process of transferring the software to the target host and then upgrading to release 7.6.

5. Click Finish when the upgrade is complete.

---

**Note:** A message may appear during the uninstallation of SSM that states `TlraSessionMgr error - Application error while referencing memory at 0x000000`. You can ignore this error, but do not click OK until the upgrade is complete.

---

6. Restart WatchDog on the IPCM. Restart all IPCSs in the network to register them with the primary IPCM.
7. Move five percent of the existing call traffic to the primary IPCM, and then monitor the system. If there are no issues, slowly increase the call traffic to 100 percent. If calls are not being processed correctly by the primary IPCM, restore the original configuration and contact Genesys Technical Support.

### Step 9—Upgrade Reporting Server(s)

Continue with the GDT to upgrade the Reporting Server(s). If you exited the GDT, you can invoke it again and select the Upgrade to GVP 7.6 radio button. On the next screen, select Use Existing EMPS to upgrade.

1. Initiate a graceful shutdown of WatchDog on the EventC host. If calls are stuck and shutdown has not occurred, you can initiate an ungraceful shutdown.

---

**Note:** While the WatchDog on EventC is down, all of the IPCSs/VCSs will be holding their events data on their local hard drive. This is expected behavior.

---

2. Install GDA on the target host as detailed in the *Genesys Voice Platform 7.6 Deployment Guide*.
3. Using the GDT, install the Reporting host components.

The Upgrade GVP Servers screen locates the GVP servers in the network that can be upgraded. The main GDT window should now show the current versions and the new versions of the GVP software that have been copied.
4. Select the target host and click Add to move it in the right window. Click Next.

This starts the process of transferring the software to the target host and then upgrading to release 7.6.
5. Click Finish when the upgrade is complete.
6. Login in as sa into the host with the SQL Server databases for the Reporting components.
7. Using SQL Query analyzer, run the following SQL scripts from the <install\_folder>\CN\sqlscripts\mssql\EventC\7.6.0 folder against the appropriate databases to update the tables schema from 7.2.x to 7.6.
  - reporter\_upgrade\_7\_6\_0\_from\_7\_2\_0.sql
  - repdwh\_upgrade\_7\_6\_0\_from\_7\_2\_0.sql
  - peaks\_upgrade\_7\_6\_0\_from\_7\_0\_3.sql
  - collector\_upgrade\_7\_6\_0\_from\_7\_2\_0.sql
8. Restart Watchdog on EventC and the Reporter hosts (if different). In approximately three to five minutes, you should begin to see the call events start arriving from the IPCSs/VCSs that they had been holding.

### Step 10—Upgrade IPCS/VCS Host(s)

Continue with the GDT to upgrade the VCS/IPCS hosts one at a time. If upgrading a VCS, first upgrade the Dialogic software to the latest version for GVP 7.6 by uninstalling the older Dialogic software, and then installing the Dialogic software using the GVP 7.6 Dialogic SR 6.0 DVD.

1. Initiate a graceful shutdown of WatchDog on the VCS/IPCS. If calls are stuck and shutdown has not occurred, you can initiate an ungraceful shutdown.
2. Install GDA on the target host as detailed in the *Genesys Voice Platform 7.6 Deployment Guide*.
3. Using the GDT, upgrade the software on the target host to release 7.6.  
The Upgrade GVP Servers screen locates the GVP servers in the network that can be upgraded. The main GDT window should now show the current versions and the new versions of the GVP software that have been copied.
4. Select the target host and click Add to move it in the right window. Click Next.  
This starts the process of transferring the software to the target host and then upgrading to release 7.6.
5. Click Finish when the upgrade is complete.
6. Restart WatchDog and move five percent of the existing call traffic to the upgraded VCS/IPCS, and then monitor the system. If there are no issues, slowly increase the call traffic. If calls are not being processed correctly by the VCS/IPCS, restore the original configuration and contact Genesys Technical Support.

---

**Notes:** TTS will not be upgraded for IPCS because it is not needed as a separate process in GVP 7.6, and it is now part of the Mcu process.

The IPCS in release 7.6 uses an Mcu process instead of the McuXml and TTS\_MRCP processes used in GVP 7.2.x. As each IPCS server is upgraded, in EMPS, under the node corresponding to that server, the McuXml node and the TTS\_MRCP node disappear and an Mcu node with ASR > MRCP and ASR > TTS subnodes appears.

---

### Step 11—Upgrade Hosts with Components that Cannot be Installed Using GDT

1. Uninstall all GVP 7.2.x components on the host using Add/Remove Programs from the Control Panel.
2. Install the new components from the GVP 7.6 DVDs by running the setup executable file each component.

You do not need to reconfigure the components in EMPS because the configuration information is already stored in the migrated EMPS 7.6 LDAP database.



---

## GVP 7.0.3 to GVP 7.6

Although a direct upgrade/migration from GVP 7.0.3 to GVP 7.6 is supported, Genesys recommends that you first upgrade/migrate to GVP 7.2.x, and then upgrade/migrate to GVP 7.6.

You can still use the following strategy to upgrade/migrate directly from GVP 7.0.3 to GVP 7.6:

- Make sure that you have upgraded third-party software required by GVP 7.6 before upgrading the GVP software.
- Follow the same procedures as detailed in the section “GVP 7.2.x to GVP 7.6” on [page 934](#).
- Make appropriate adjustments in the scripts to be run. For example, the following EventC SQL scripts must be replaced by the appropriate scripts for 7.0.3:
  - `reporter_upgrade_7_6_0_from_7_2_0.sql`
  - `repdwh_upgrade_7_6_0_from_7_2_0.sql`
  - `peaks_upgrade_7_6_0_from_7_0_3.sql`
  - `collector_upgrade_7_6_0_from_7_2_0.sql`

---

## GVP 6.5.x to GVP 7.6

Although a direct upgrade/migration from GVP 6.5.x to GVP 7.6 is supported, Genesys recommends that you first upgrade/migrate to GVP 7.2.x, and then upgrade/migrate to GVP 7.6.

You can still use the following strategy to upgrade/migrate directly from GVP 6.5.x to GVP 7.6:

- GVP 6.5.x is only supported on Windows 2000 server, and GVP 7.6 is only supported on Windows 2003 server. Therefore, it is not possible to upgrade/migrate existing GVP 6.5.x servers to GVP 7.6 servers because you cannot change the underlying operating system from Windows 2000 to Windows 2003 while maintaining the GVP software. You must install GVP 7.6 software on new servers running Windows 2003 server software.
- The Data Migration Tool in EMPS has a Server Mapping feature that can help you move existing customer/application data to a new network. It provides a mapping capability by which old server names can be mapped to new server names, and the data transformation will also change the server names, where applicable. You should use this feature to preserve the configuration of the GVP 6.5.x servers while installing the GVP 7.6 software on new Windows 2003 servers.

### Important

The source server and target server in the Server Mapping window must have the same combination of components. For example, if the source

server has IPCS, PM, and BWM, the target server must only have IPCS, PM, and BWM.

The proper sequence to do this is:

- Install GVP 7.6 EMPS on a new Windows 2003 server.
- Run the Data Migration Tool on the new Windows 2003 server that will host the 7.6 EMPS, to migrate the data from GVP 6.5.x provisioning system to GVP 7.6 EMPS. Use the Server Mapping option for using new servers.
- Install release 7.6 software on non-EMPS GVP servers that have Windows 2003 installed on them.
- Make sure that you have upgraded third-party software required by GVP 7.6 before upgrading the GVP software.
- Follow the same procedures as detailed in the section “GVP 7.2.x to GVP 7.6” on [page 934](#); however, use the Server Mapping feature in the Data Migration Tool and install the new GVP 7.6 software manually (see the *Genesys Voice Platform 7.6 Deployment Guide* for instructions on how to manually install the components).
- Make appropriated adjustments in the scripts to be run. For example, the following EventC SQL scripts must be replaced by the appropriate scripts for 6.5.x:
  - reporter\_upgrade\_7\_6\_0\_from\_7\_2\_0.sql
  - repdwh\_upgrade\_7\_6\_0\_from\_7\_2\_0.sql
  - peaks\_upgrade\_7\_6\_0\_from\_7\_0\_3.sql
  - collector\_upgrade\_7\_6\_0\_from\_7\_2\_0.sql



## Chapter

# 55

## Upgrading to Genesys Voice Platform 7.5

This chapter discusses the procedures and order for upgrading to Genesys Voice Platform (GVP) 7.5.

---

**Note:** The conventions used in this chapter are:

- *Upgrade*—refers to replacing previous versions of GVP software with GVP 7.5 software.
- *Migrate*—refers to migrating Voice Portal Manager (VPM) data from Genesys Voice Platform: Enterprise Edition (GVP: EE) or migrating Element Management Provisioning System (EMPS) data from Genesys Voice Platform: Network Edition (GVP: NE) to the 7.5 EMPS.

---

This chapter includes the following sections:

- [Considerations when Migrating to Genesys Voice Platform 7.5, page 952](#)
- [Overview, page 952](#)
- [EMPS, page 956](#)
- [Migrating Data, page 957](#)
- [Upgrading Components, page 965](#)
- [Upgrading Databases, page 971](#)
- [Upgrade Considerations, page 976](#)
- [Upgrading from Windows 2000 to Windows 2003, page 987](#)

---

## Considerations when Migrating to Genesys Voice Platform 7.5

- Non-Media Resource Control Protocol (MRCP) Automatic Speech Recognition (ASR) and Text-to-Speech (TTS) are no longer supported on GVP 7.5. You must upgrade your speech engines to MRCP compliant versions.
- Applications using earlier speech engines may need to be rewritten or at least re-tuned, unless they were using MRCP already.
- GVP 7.5 supports VoiceXML 2.1 (PR) and VoiceXML 2.0 (R) standards. Applications following earlier versions of VoiceXML need to be upgraded.
- It is possible to migrate directly to GVP 7.5 from VWAP 6.5.4, GVP: EE 6.5.5, GVP: DE 6.5.4, GVP: EE 7.0.2, GVP: EE 7.0.3, GVP: NE 7.0.3, GVP: DE 7.0.3, GVP: EE 7.2, GVP: NE 7.2, and GVP: DE 7.2 without going through any intermediate steps. However, it is not possible to migrate from versions earlier than VWAP 6.5.4, GVP: EE 6.5.5 and GVP: DE 6.5.4 to GVP 7.5.
- The GVP: EE 7.2 Solution Installer allows automated migration of software and configuration of GVP: EE software and features. See Chapter 57, “Migration for Genesys Voice Platform: Enterprise Edition,” on [page 1009](#) for details. However, GVP: NE and GVP: DE migration is completely manual.
- Genesys Voice Platform Studio 7.5 allows automatic migration of applications written with Studio 6.5.4, Studio 6.5.5, Studio 7.0.3, and Studio 7.2. This includes migration from VoiceXML 2.0 PR standard to VoiceXML 2.1, but does NOT include migration of ASR/TTS engine specific grammars/TTS to Speech Recognition Grammar Specification (SRGS)/Speech Synthesis Markup Language (SSML) standards-based applications needed to work with MRCP. The changing of grammars and TTS tags to be compliant with the new MRCP engines has to be done manually. For more details see Chapter 59, “Migration for Genesys Voice Platform: Studio,” on [page 1029](#).

---

## Overview

The sequence for performing a GVP upgrade preserves your previous EMPS or VPM configurations; however, make sure that you back up existing configuration information to facilitate reconfiguration after upgrading, and in case you must roll-back the upgrade. The sequence for upgrading is:

1. Install EMPS 7.5. For more information, see “EMPS” on [page 956](#).
2. Perform data migration of VPM or EMPS data to the 7.5 EMPS. For more information, see “Migrating Data” on [page 957](#).

3. Upgrade the software. For more information, see “Upgrading Components” on [page 965](#).

---

**Note:** Upgrading to GVP 7.5 must be performed only by qualified professionals with extensive knowledge of the GVP system. Contact your Genesys representative for specific guidance and assistance with your upgrade strategy. With the assistance of your Genesys representative, you must create a plan for the upgrade/install, and you must customize the upgrade steps. Each customer will have a unique plan for upgrading/installing, according to the configuration of their system.

For more information about GVP 7.5, see the GVP 7.5 Release Notes found on the Genesys Technical Support website at <http://genesyslab.com/support>.

---

## GVP Deployment Tool

You must use one of the following two methods to upgrade GVP: EE or GVP: NE/Voice Web Application Platform (VWAP):

- GVP Deployment Tool (GDT)—This tool upgrades GVP software and configures it in the 7.5 EMPS. Using the GDT saves time and keystrokes, and reduces the likelihood of mistakes. This chapter assumes that you are using the GDT. For more information about the GDT, see Chapter 5 in the *Genesys Voice Platform 7.5 Deployment Guide*.

---

**Note:** The GDT will not configure the GVP components if they are upgraded from a previous version.

---

- Manual upgrade—For any component to be upgraded by a manual installation, you must first uninstall all of the prior software versions. You must then manually install and configure the components.

## Upgrading GVP to GVP 7.5

The process to upgrade GVP: EE or GVP: NE/VWAP is identical. The GDT removes the previous versions of the software, and then installs and configures GVP 7.5. The GVP: NE/VWAP is a much larger upgrade that requires special considerations. For more information about these considerations, see “Upgrade Considerations” on [page 976](#).

### Preparing to Upgrade

Before upgrading your GVP software, make sure that all of the GVP components work correctly under your current release. All components must be running the Generally Available (GA) versions. For this upgrade, post-GA

hot fixes are optional. Do not attempt to upgrade a non-working GVP system to GVP 7.5, because it might be difficult to get the 7.5 GVP system to operate.

## Component Compatibility

Some of the GVP component names have changed between prior releases of GVP and GVP 7.5. [Table 163](#) lists these name changes.

**Table 163: Component Compatibility**

| GVP Pre 7.5 Components                        | GVP 7.5 Components                                                                                                                                                                                         |
|-----------------------------------------------|------------------------------------------------------------------------------------------------------------------------------------------------------------------------------------------------------------|
| Voice Web Manager (VWM)                       | Element Management System (EMS)                                                                                                                                                                            |
| Genesys Queue Adapter (GQA)                   | IVR Server Client                                                                                                                                                                                          |
| Voice Portal Manager (VPM)                    | Element Management Provisioning System (EMPS)                                                                                                                                                              |
| Element Management Provisioning System (EMPS) | Element Management Provisioning System (EMPS)                                                                                                                                                              |
| Voice Web Manager Call Manager (VWCM)         | Voice Platform Resource Manager (RM)<br>Voice Platform SIP Session Manager (SSM)<br>Voice Platform H.323 Session Manager (HSM)<br><b>Note:</b> These components are referred to as IP Call Manager (IPCM). |
| Voice Web Voice Communication Server (VCS)    | Voice Platform Voice Communication Server (VCS)                                                                                                                                                            |
| Voice Web IP Communication Server (IPCS)      | Voice Platform IP Communication Server (IPCS)                                                                                                                                                              |
| Voice Web Text-To-Speech (TTS)                | Voice Platform Text-to-Speech (TTS)                                                                                                                                                                        |

## Upgrade Strategy

This section describes the general strategy for an upgrade. The specific upgrade instructions are found in “Upgrading Components” on [page 965](#).

### Step 1—Load the New MIBs

If you are using a Network Management System (NMS) that receives Simple Network Management Protocol (SNMP) traps from GVP, load the 7.5 GVP Management Information Bases (MIBs) into the NMS before installing any

GVP components. Consult your NMS user guide for instructions on loading the MIBs.

Loading new MIBs ensures that any traps generated by the new GVP 7.5 are represented in your NMS. See Appendix B in the *Genesys Voice Platform 7.5 Deployment Guide* for instructions on how to extract GVP 7.5 MIBs. If pre-GVP 7.5 MIBs exist on the NMS, overwrite them with the GVP 7.5 MIBs.

---

**Note:** If no NMS is deployed, this step does not apply.

---

### Step 2—Upgrade EMPS

For GVP: NE, using the GDT, install EMPS on a new server, and then perform a data migration.

For GVP: EE, using the GDT, install EMPS to replace the VPM, either on a new server or on an existing VPM, and then perform a data migration.

For more information about EMPS, see “EMPS” on [page 956](#).

### Step 3—Upgrade the EMS Components

Genesys recommends that you upgrade the EMS components in the order that follows. This enables you to verify the operation of each component, and minimizes the impact on existing calls. You must run the GDT multiple times to achieve an ordered update.

1. Bandwidth Manager (BWM)—During the upgrade of BWM, the VCS sends the required available files instead of waiting for BWM to schedule the transfers. For more information, see “Upgrading Bandwidth Manager” on [page 969](#).
2. Policy Manager (PM)—The PM controls customer and application port utilization. If the PM is not available, the calls will be accepted after the primary (and backup, if provisioned) PM fails to respond. This affects control of port utilization and real time reporting. For more information, see “Upgrading Policy Manager” on [page 969](#).
3. Telera Queue Adapter (TQA)—Upgrade to GVP 7.5 is not available.
4. Genesys Queue Adapter (GQA) and/or Cisco Queue Adapter (CQA)—You can upgrade these components one at a time by directing traffic to the upgraded GQA and/or CQA. For more information, see “Upgrading IVR Server Client” on [page 969](#), and “Upgrading the Cisco Queue Adapter” on [page 970](#).

The queue adapters interface with Computer Telephony Integration (CTI). If a call cannot communicate with the adapters, the voice application generates an `error.com.telera.queue` error. If the error is not handled, the call will be dropped. All existing calls will also be dropped.

---

**Note:** IVR Server Client and GQA are different names for the same component.

---

5. Outbound Notification (OBN)—Outbound notification cannot be performed during the upgrade. For more information, see “Upgrading Outbound Notification” on [page 970](#).
6. ASR Log Manager—File capture and transfer from VCS/IPCS must not be enabled during the upgrade. For more information, see “Upgrading ASR Log Manager Components” on [page 970](#).

#### Step 4—Upgrade the Voice Components

1. Voice over IP (VoIP): IP Call Manager (IPCM) and IP Communication Server (IPCS)—For more information, see “Upgrading IP Call Manager” on [page 966](#) and “Upgrading IPCS” on [page 966](#).
2. Time Division Multiplexing (TDM): Voice Communication Server (VCS)—For more information, see “Upgrading VCS” on [page 965](#).

#### Step 5—Upgrade the Reporting Components

1. EventC, Reporter, and Unified Login Server—For more information, see “Upgrading EventC and Reporting” on [page 967](#).
2. Network Monitor—For more information see, “Upgrading Network Monitor Database” on [page 971](#).

---

## EMPS

GVP 7.5 uses the EMPS to provide configuration and provisioning parameters. In prior releases, GVP: EE used VPM, GVP: NE used EMPS, and VWAP used VWPS.

In GVP 7.5, EMPS works differently than it did in previous releases. Prior to GVP 7.5, EMPS stored all of the necessary information in an LDAP Directory Server. When a GVP: NE server required startup information, it retrieved configuration parameters from that LDAP Directory Server. GVP 7.5 servers must connect to EMPS to retrieve configuration parameters.

---

**Note:** SunOne Directory Server and OpenLDAP are supported in GVP 7.5.

---

If you are upgrading from GVP: NE, you must install EMPS as multi-tenant on a new server.

If you are upgrading from GVP: EE, Genesys recommends that you install EMPS as single-tenant on a new server; but it can be installed on an existing VPM server. If the existing VPM system has other GVP components



(including Dialogic), you must uninstall them, using Windows Add/Remove, before installing EMPS.

- Using the GDT, install the 7.5 EMPS on a new server. For more information on how to install EMPS, see the *Genesys Voice Platform 7.5 Deployment Guide*.

---

## Migrating Data

The Data Migration Tool (DMT) is a wizard that migrates provisioning data from a pre-7.5 GVP (NE or EE) EMPS or VPM, to 7.5 EMPS. Run the data migration after the installation of 7.5 EMPS, and before you upgrade any software.

This section provides instructions on how to use the Data Migration Tool (DMT).

### Using the Data Migration Tool

1. To launch DMT on the EMPS 7.5 server, double-click the file `<install directory>\bin\run_dmt.bat`. The Welcome to the GVP Data Migration Tool screen appears (see [Figure 36](#)).

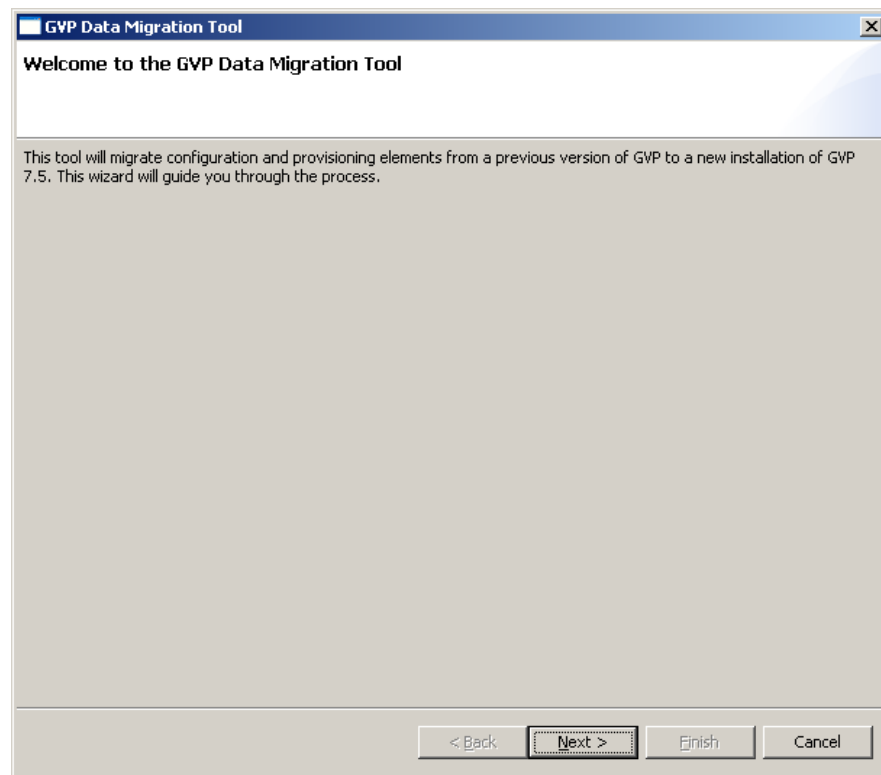

**Figure 36: GVP Data Migration Tool Welcome Screen**

2. Click Next. The License Agreement screen appears.
3. Click Yes to agree with the license agreement, and then click Next. The Version Selection screen appears (see [Figure 37](#)).

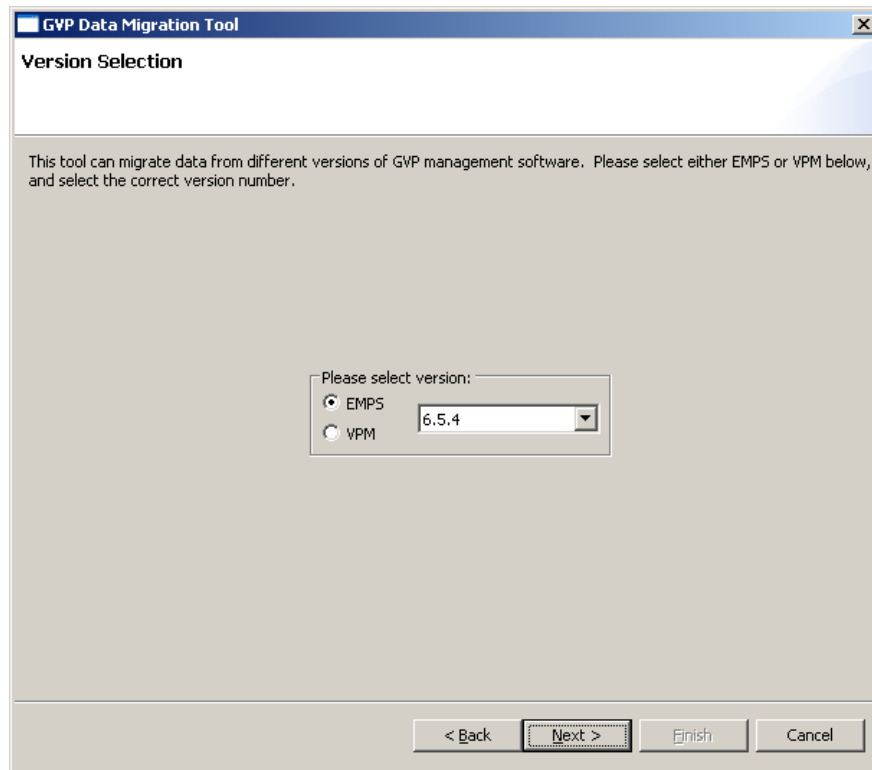

**Figure 37: GVP Data Migration Tool Version Selection Screen**

4. Select the source installation type. Select EMPS if your current working release is GVP: NE, or select VPM if your current working release is GVP: EE.
5. From the drop-down list, select your current source version number.
6. Click Next.

If EMPS is selected, the EMPS Source Configuration screen appears (see [Figure 38](#)).

GVP Data Migration Tool

### EMPS Source Configuration

Please enter the configuration information for the EMPS system that you are migrating from. The migration tool will contact the server to download configuration data, and transfer the data to the new EMPS system.

Please fill in the form items:

EMPS Host

< Back   Next >   Finish   Cancel

**Figure 38: GVP Data Migration Tool EMPS Source Configuration Screen**

(Step 6. cont'd) EPMS Source Configuration

- a. In the EMPS Host text box, enter the hostname or IP address of the source EMPS installation.
- b. Click Next.

If VPM is selected, the VPM Source Configuration screen appears (see [Figure 39](#)).

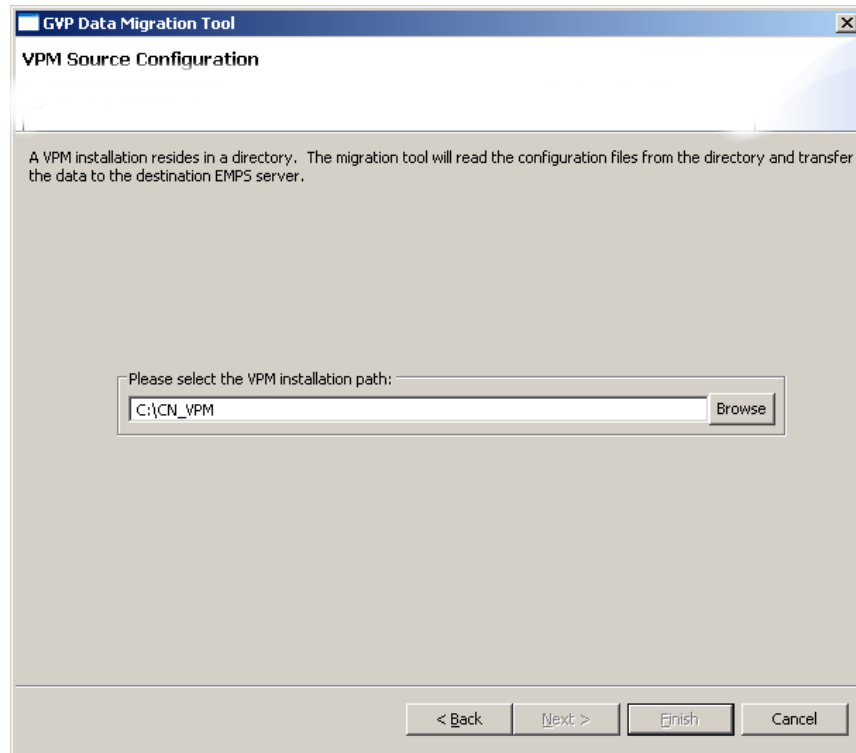

**Figure 39: GVP Data Migration Tool VPM Source Configuration Screen**

(Step 6. cont'd) VPM Source Configuration

- a. Click Browse to select the VPM installation path. This can be a mapped drive, a local drive if EMPS is already installed on the VPM server, or it can be a copy of the cn\_vpm folder.
- b. Click Next.

The EMPS Destination Configuration screen appears (see [Figure 40](#)).

**GVP Data Migration Tool**

### EMPS Destination Configuration

Please enter the configuration information for the new EMPS system that you are migrating to. The migration tool will transfer the data on your existing server to the new server.

Please fill in the form items:

|           |                                |
|-----------|--------------------------------|
| EMPS Host | http://dev-neutron.us.int.gene |
| Username  | admin                          |
| Password  | •••••••                        |

< Back   Next >   Finish   Cancel

**Figure 40: GVP Data Migration Tool EMPS Destination Configuration Screen**

(Step 6. cont'd) EMPS Destination Configuration

- a. In the EMPS Host text box, enter the Fully Qualified Domain Name (FQDN) of the EMPS 7.5 host.
- b. In the Username text box, enter the login username for EMPS 7.5.
- c. In the Password text box, enter the login password for EMPS 7.5.
- d. Click Next.

The Migration Options screen appears (see [Figure 41](#)).

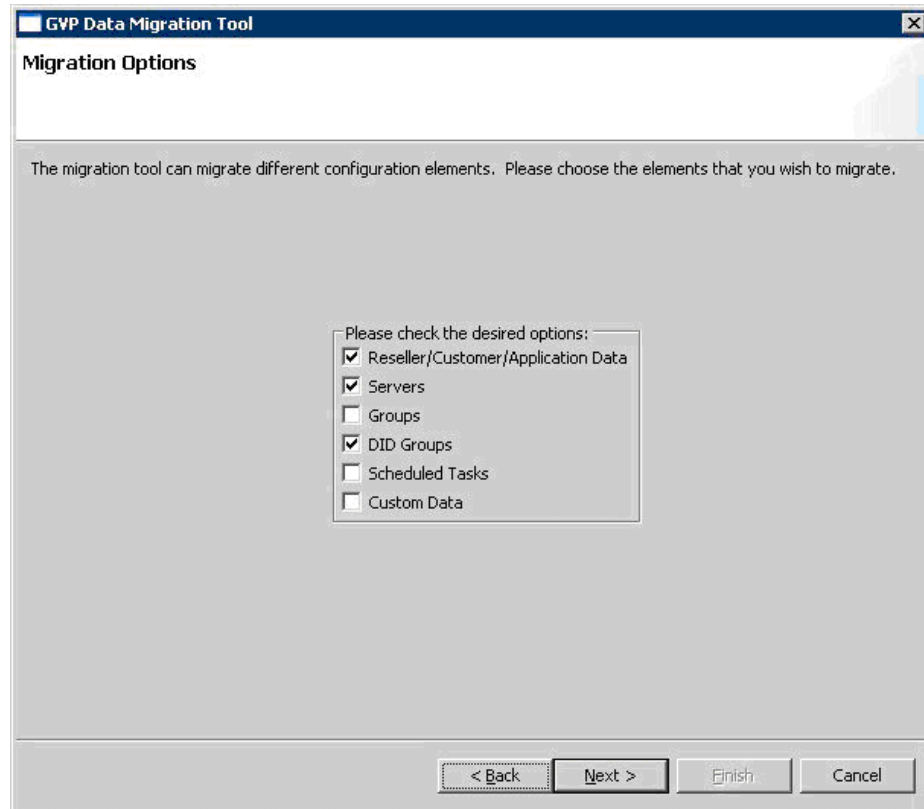

**Figure 41: GVP Data Migration Tool Migration Options Screen**

7. From the list of configuration elements, select the elements to migrate.
  - Resellers/Customer/Application Data
  - Servers
  - Groups
  - DID Groups
  - Scheduled Tasks
  - Custom Data

---

**Note:** If you are migrating data from VPM, only the Reseller/Customer/Application Data and Servers elements will be available for selection.

---

The executable file `SCAImport.exe` migrates the data. If it cannot be found in the default path, a message appears, and the DMT prompts for the location of the file. Click Browse for `SCAImport` and select `<EMPS install directory>\bin\SCA.exe`.

8. Click Next. The Dispenser Information screen appears (Figure 42).

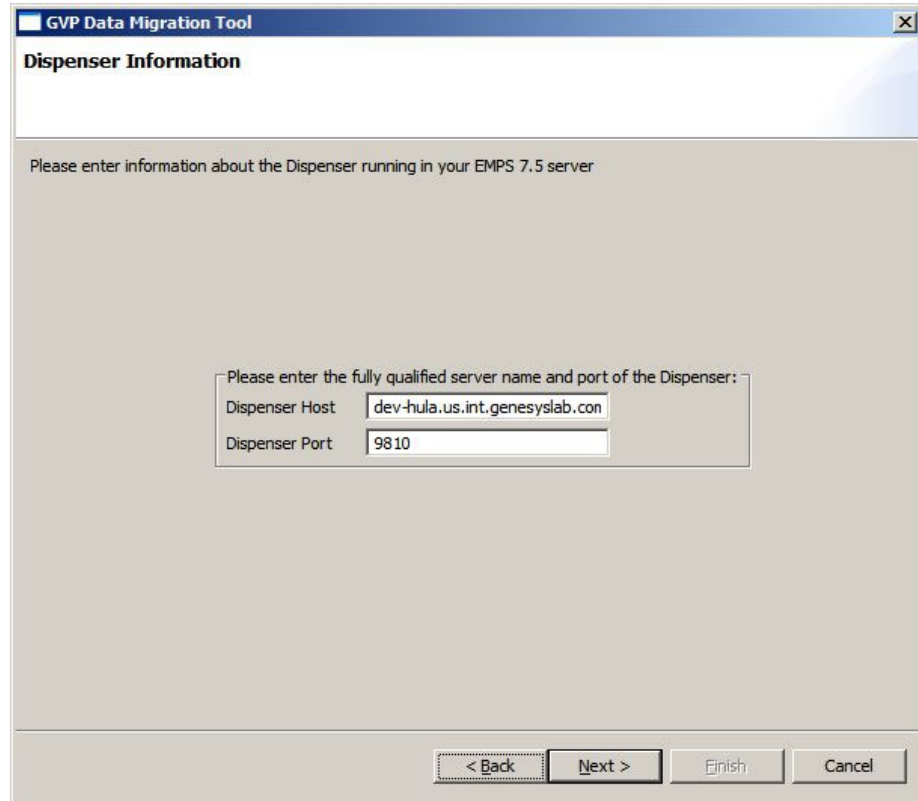

The screenshot shows a window titled "GVP Data Migration Tool" with a sub-header "Dispenser Information". Below the header, there is a prompt: "Please enter information about the Dispenser running in your EMPS 7.5 server". A smaller box contains the instruction: "Please enter the fully qualified server name and port of the Dispenser:". Below this, there are two text input fields: "Dispenser Host" with the value "dev-hula.us.int.genesyslab.com" and "Dispenser Port" with the value "9810". At the bottom of the window, there are four buttons: "< Back", "Next >", "Finish", and "Cancel".

**Figure 42: GVP Data Migration Tool Dispenser Information Screen**

9. In the `Dispenser Host` text box, enter the FQDN of the Dispenser host.
10. In the `Dispenser Port` text box, enter the port of the Dispenser host.
11. Click `Next`. The `Confirm Settings` screen appears (see [Figure 43](#)).

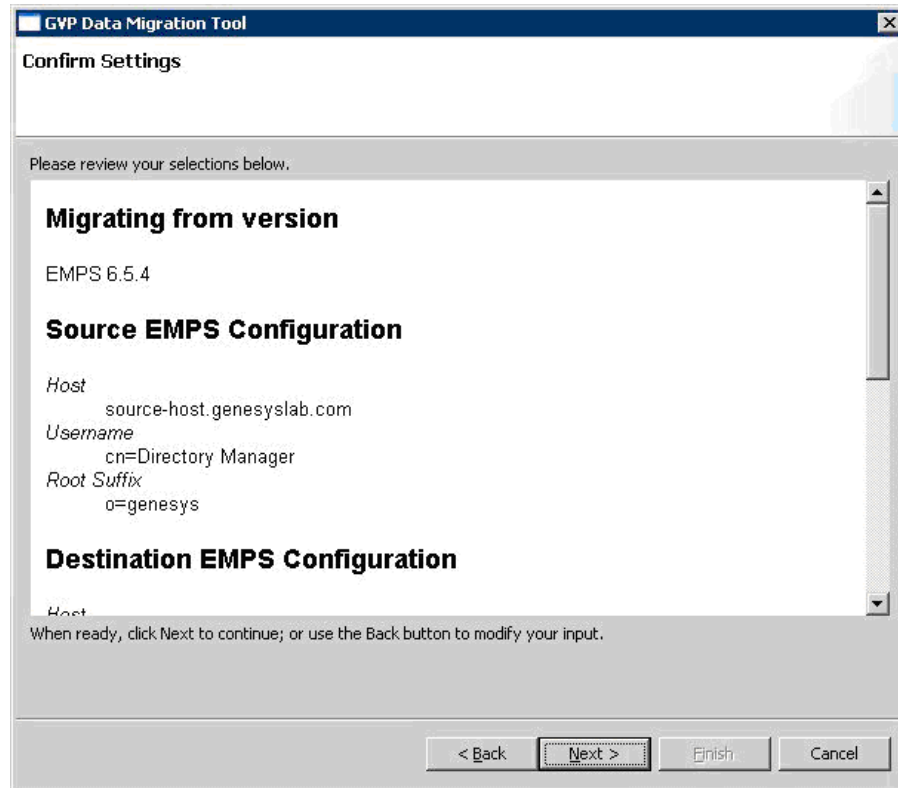

**Figure 43: GVP Data Migration Tool Confirm Settings Screen**

12. Review the selections. Click Back if you need to make changes.
13. Click Next. The Start button appears.
14. Click Start.

---

**Note:** You can click Cancel at any time to stop the data migration.

---

15. When the data migration is complete, click Finish.

After data migration, the EMPS will not reflect the correct format of the fields. All of the migrated fields in EMPS will be preceded with an exclamation mark because the 7.5 template has not yet been assigned to the specific server. Once the upgrade is complete and the 7.5 templates are assigned, the EMPS fields appear as expected. Although the GDT configures most parameters, you are responsible for ensuring that specific servers are configured correctly after upgrading. For example, if you want to use a different dispenser, you must correct the dispenser address.



---

## Upgrading Components

When upgrading, it is important to note that the GDT upgrades all of the software on a server. Although individual servers can be upgraded one at a time, you cannot choose which components to upgrade. For example, if a GVP 7.2 server has both Policy Manager and EventC installed on it, the GDT upgrades both components to 7.5.

---

**Warning!** Genesys recommends that you read this *Upgrading Components* section first, noting the upgrade sequence and procedures before actually performing the upgrade.

---

## Upgrading VCS

Before upgrading VCS, you must first upgrade Dialogic with the latest patches and features. For more information on how to upgrade Dialogic, see the *Genesys Voice Platform 7.5 Deployment Guide*. After Dialogic has been upgraded, you may then upgrade VCS to GVP 7.5 VCS.

---

**Note:** If there is only one VCS, it will not be able to take calls during the upgrade process. If there are multiple VCSs, GVP continues to take calls, but at a reduced capacity.

---

### To upgrade multiple VCSs:

1. Select a single VCS to upgrade.

When upgrading a network with multiple VCSs, Genesys recommends upgrading one VCS and then testing an application before upgrading the entire network of VCSs. If calls are presented to the VCS network in a round-robin method, select one VCS for upgrade. If calls are presented to the VCS network in a first-idle method, select a VCS in the network that will receive some calls, so that the upgrade can be verified.

2. Route calls away from the VCS to be upgraded.

Before upgrading the target VCS, Genesys recommends that the switch route all calls landing on the target VCS to other VCSs in the network. If this is not done, callers might experience delays when the switch performs automatic hunting to the other VCSs in the network.

3. Using the EMS GUI, gracefully shut down the WatchDog on the VCS machine.
4. Using the GDT, upgrade the VCS. For more information, see the *Genesys Voice Platform 7.5 Deployment Guide*.
5. Place one test call on the upgraded VCS to test the application before routing traffic back to it.

6. Route calls back to the upgraded VCS.
7. Repeat the preceding steps for the remaining VCSs in your network.

## Upgrading IP Call Manager

This section describes the steps required to upgrade the IP Call Manager (IPCM) to 7.5.

You must shut down the system in order to upgrade IPCM.

1. To prevent lost calls during the upgrade, make sure that there are no calls in the system.
2. Using the GDT, upgrade the software on the IPCM server(s). For more information, see the *Genesys Voice Platform 7.5 Deployment Guide*.

---

**Note:** You cannot test IPCM until at least one IPCS has been upgraded.

---

For more information about upgrading IPCM while still processing calls, see “Call Manager (SIP)” on [page 983](#).

## Upgrading IPCS

This section describes the steps required to upgrade the IP Communication Server (IPCS) to 7.5.

---

**Notes:** SIP Session Manager (SSM) and H.323 Session Manager (HSM) must be upgraded before upgrading IPCS.

If there is only one IPCS, it will not be able to take calls when upgrading. If there are multiple IPCSs, GVP continues to take calls, but at a reduced capacity

---

1. Select one IPCS to upgrade.

When upgrading a network with multiple IPCSs, Genesys recommends upgrading one IPCS, and then testing an application before upgrading the entire network of IPCSs. Calls are presented to the IPCS in a round-robin method; therefore, you may select any IPCS in the network to upgrade.

2. Using the EMS GUI, gracefully shut down the WatchDog on the IPCS machine.

This causes the SSM or HSM to remove all ports associated with the target IPCS being removed from service. No additional calls will be presented to the target IPCS.

3. Using the GDT, upgrade the IPCS. For more information, see the *Genesys Voice Platform 7.5 Deployment Guide*.

Once IPCS is operational, SSM or HSM automatically start routing calls to it.

**IPCS  
Configuration  
Updates**

4. Apply the following IPCS configuration updates:
- a. The `Default Media Codec` parameter has moved from under the `popgateway` node to the `Mcuxml` node. In order to migrate successfully, you must manually configure the `Default Media Codec` parameter to match the previous setting.
  - b. The `Call Status Check Frequency` parameter for IPCS in the `popgateway` section of EMPS has been deprecated. `Call Status Check Frequency` was used to determine if the `Sessions Timers` parameter was to be enabled (set to a value greater than 0). If enabled, the `Session Timer Interval` would be set to the same value as specified for the `Call Status Check Frequency`.
  - c. GVP 7.5 now uses `Enable Session Timers` and `Session Timer Interval` instead of `Call Status Check Frequency`.  
If `Call Status Check Frequency` was a non-zero value before migrating:
    - Select the `Enable Session Timers` check box to enable session timers in GVP 7.5.
    - Set the `Session Timer Interval` (in seconds) to the same value as specified for the `Call Status Check Frequency` parameter.
 If `Call Status Check Frequency` was previously zero, then clear the `Enable Session Timers` check box to disable it.
  - d. The `Local Tone Rendering` parameter for IPCS in the `popgateway` section of EMPS has been deprecated. When configuring after migration, use the value of the `Local DTMF Rendering` parameter to set the `Fallback DTMF mode` in GVP 7.5. The following parameter compatibility table shows the differences (see [Table 164](#)):

**Table 164: Parameter Compatibility**

| Local DTMF Rendering in Previous Version | Fallback DTMF Mode in 7.5 | Differences                                                                                             |
|------------------------------------------|---------------------------|---------------------------------------------------------------------------------------------------------|
| RTP using RFC-2833                       | SIP INFO                  | SIP INFO will now be used as a backup if RFC 2833 cannot be negotiated.                                 |
| SIP INFO Msg                             | SIP INFO                  | RFC 2833 will now be used if available.                                                                 |
| Digitized Inband RTP                     | Inband                    | RFC 2833 will now be used if available. DTMF inband will be used only if RFC 2833 cannot be negotiated. |

## Upgrading EventC and Reporting

The following procedure enables the operator to upgrade from previous versions of GVP/VWAP (source) to GVP 7.5 (destination). You must consult

with a qualified database administrator in order to properly transfer SQL data from one server to another.

1. Make a backup of the following databases:
  - Collector
  - Reporter
  - Reporter Data Warehouse (RepDWH)
  - Peaks
  - UnifiedLogin
2. Stop WatchDog in the EventC server, and then make a backup of all the folders in the data directory `c:\<GVP Install Directory>\data`.
3. Make a backup of the `c:\<GVP Install Directory>\log` for future reference.
4. Replace the backed-up folders to the appropriate places after the upgrade is complete.
5. Using the GDT, upgrade the EventC, and register it with the GVP 7.5 EMPS. For more information, see the *Genesys Voice Platform 7.5 Deployment Guide*.
6. Stop the billing port (Port#=9810/9811) on the EventC server (source). This ensures that the IPCS/VCS can no longer send call events to the EventC server.

---

**Note:** The communication servers store these events locally on disk. Ensure that each individual communication server has sufficient disk space to store the call events generated during the cutover period.

During the cutover period, the communication servers send `Billing data send failed` SNMP traps to the Network Management Console.

---

7. Allow Events Loader on the EventC server (source) to run at least two cycles after the billing port (Port#=9810/9811) has been stopped. This ensures that all pending call-event data files in the `Current` data directory (`\cn\data\current`) are loaded into the SQL database on the old EventC server (source). Verify that there are no files left under the `Current` data directory on the old EventC server (source) before proceeding to the next step.
8. Check for remaining files. If you find any, make a backup of them, and then manually move them to the corresponding directory on the newer installed version. Also, make a backup of the `c:\<GVP Install Directory>\data\archives` and `c:\<GVP Install Directory>\data\exceptions` directories. Manually place them on the corresponding directory of the new upgraded version. Make a backup of the log folder for future reference.

For information about upgrading a standby EventC, see “EventC Standby Configuration” on [page 976](#).

For information about upgrading the EventC databases, see “Upgrading Databases” on [page 971](#).

## Upgrading Policy Manager

This section describes the step required to upgrade Policy Manager (PM) to 7.5.

---

**Note:** The PM server must be taken out of service during the upgrade. Genesys recommends that an additional server be used for a smooth upgrade from the existing PM to the GVP 7.5 PM.

---

- Using the GDT, upgrade the PM, and register it with GVP 7.5 EMPS. For more information, see the *Genesys Voice Platform 7.5 Deployment Guide*.

For information about upgrading PM while still processing calls, see “Upgrading Policy Manger in Real-Time” on [page 977](#).

For information about upgrading a primary and a backup PM, see “Upgrading a Primary and Backup Policy Manager” on [page 977](#).

## Upgrading Bandwidth Manager

This section describes the step required to upgrade the Bandwidth Manager (BWM) to 7.5.

- Using the GDT, upgrade the BWM on a new server, and register it with the GVP 7.5 EMPS. For more information, see the *Genesys Voice Platform 7.5 Deployment Guide*.

For information about upgrading BWM while still processing calls, see “Upgrading Bandwidth Manager in Real-Time” on [page 978](#).

## Upgrading IVR Server Client

This section describes the step required to upgrade the IVR Server Client to 7.5.

---

**Note:** This component was named Genesys Queue Adapter (GQA) in VWAP 6.5.4.

---

- Using the GDT, upgrade the IVR Server Client on a new server, and register it with the GVP 7.5 EMPS. For more information, see the *Genesys Voice Platform 7.5 Deployment Guide*.

For information about upgrading IVR Server Client while still processing calls, see “Upgrading IVR Server Client in Real-Time” on [page 979](#).

For information about upgrading a primary and backup IVR Server Client, see “Upgrading a Primary and Backup IVR Server Client” on [page 979](#).

## Upgrading the Cisco Queue Adapter

This section describes the step required to upgrade the Cisco Queue Adapter (CQA) to 7.5.

---

**Note:** The CQA server must be taken out of service during the upgrade. Genesys recommends that an additional server be used for a smooth upgrade from the existing CQA to the GVP 7.5 CQA.

---

- ♦ Using the GDT, upgrade the CQA, and register it with the GVP 7.5 EMPS. For more information, see the *Genesys Voice Platform 7.5 Deployment Guide*.

For information about upgrading CQA while processing calls, see “Upgrading Cisco Queue Adapter in Real-Time” on [page 980](#).

For information about upgrading a primary and backup CQA, see “Upgrading a Primary and Backup CQA” on [page 981](#).

## Upgrading ASR Log Manager Components

This section describes the steps required to upgrade the Automatic Speech Recognition (ASR) Log Manager components to 7.5.

---

**Note:** ASR Log Manager was not supported in GVP 7.0.3 or GVP 7.2. If you are upgrading GVP from GVP: NE 7.x, install the ASR Log Manager components according to the *Genesys Voice Platform 7.5 Deployment Guide*.

---

- ♦ Upgrade VWAP 6.5.4 ASR Log Manager to GVP 7.5:
  - ♦ Install GVP 7.5 ASR Log Agent on the SWMS server. For more information, see the *Genesys Voice Platform 7.5 Deployment Guide*.
  - ♦ Using the GDT, upgrade the ASR Log Manager and the ASR Log Server. For more information, see the *Genesys Voice Platform 7.5 Deployment Guide*.

For information about configuring ASR Log Manager for Media Resource Control Protocol (MRCP), see “Configuring ASR Log Manager for MRCP” on [page 982](#).

## Upgrading Outbound Notification

This section describes the step required to upgrade the Outbound Notification (OBN) to 7.5.

- ♦ Using the GDT, upgrade to the GVP 7.5 OBN on the current OBN server, and register it with the GVP 7.5 EMPS. For more information, see the *Genesys Voice Platform 7.5 Deployment Guide*.

---

# Upgrading Databases

This section describes the steps required to upgrade the GVP databases.

## Upgrading Network Monitor Database

1. Delete the existing NetMon database.
2. Create a new database called NetMon.
3. Run the NetMon\_from\_scratch\_7\_5\_0.sql script located in the directory <GVP install directory>\cn\sql\scripts\msql\7.5.0.
4. Check for any errors.
5. Close the file.
6. Restart the Network Monitor processes.

## Upgrading Collector Database

1. Stop the Events Loader and Events Validator processes.
2. Back up the Collector database.
3. Open the Query Analyzer.

---

**Note:** Consult with your Database Administrator (DBA) for assistance.

---

4. Connect to the database server as Collector database user, using the source configuration information.
5. Point the Query Analyzer to the Collector database, if the Query Analyzer does not automatically find it.
6. Click the Load SQL Script icon on the SQL Query Analyzer.
7. If upgrading from VWAP 6.5.4, browse and locate the following file:  
<InstallDir>\sqlscripts\mssql\EventC\7.5.0\collector\_upgrade\_7\_5\_0\_from\_6\_5\_4.sql  
If upgrading from GVP 7.0.3, browse and locate the following file:  
<InstallDir>\sqlscripts\mssql\EventC\7.5.0\collector\_upgrade\_7\_5\_0\_from\_7\_0\_3.sql
8. Select and execute the file by pressing F5 or the execute icon. This might take some time to complete, depending upon the volume of data.
9. Check for any errors.

10. Close the file.
11. Start the Events Loader process.

## Upgrading Peaks Database

1. Stop the Call Records Generator and Peaks Calculator processes.
2. Back up the Peaks database.
3. Open the Query Analyzer.
4. Connect to the database server as Peaks database user, using the source configuration information.
5. Point the Query Analyzer to the Peaks database, if the Query Analyzer does not automatically find it.
6. Click the Load SQL Script icon on the SQL Query Analyzer.
7. If upgrading from VWAP 6.5.4, browse and locate the following file:  
<InstallDir>\sqlscripts\mssql\EventC\7.5.0\peaks\_upgrade\_7\_5\_0\_from\_6\_5\_4.sql  
If upgrading from GVP 7.0.3, browse and locate the following file:  
<InstallDir>\sqlscripts\mssql\EventC\7.5.0\peaks\_upgrade\_7\_5\_0\_from\_7\_0\_3.sql  
If upgrading from GVP 7.2, browse and locate the following file:  
<InstallDir>\sqlscripts\mssql\EventC\7.5.0\peaks\_upgrade\_7\_5\_0\_from\_7\_2\_0.sql
8. Select and execute the file by pressing F5 or the execute icon.
9. Check for any errors.
10. Close the file.
11. Start the Call Records Generator and Peaks Calculator processes.

## Upgrading Reporter Database

1. Stop the CallRecordsGenerator and Peaks Calculator processes (PeaksNSP, PeaksReporter, and PeaksAIM).
2. Shut down the Reporter website.
3. Back up the Reporter database.
4. Open the Query Analyzer.
5. Connect to the database server as Reporter database user, using the source configuration information.
6. Point the Query Analyzer to the Reporter database, if the Query Analyzer does not automatically find it.
7. Click the Load SQL Script icon on the SQL Query analyzer.



8. If upgrading from VWAP 6.5.4, browse and locate the following file:  
`<InstallDir>\sqlscripts\mssql\EventC\7.5.0\reporter_upgrade_7_5_0_from_6_5_4.sql`  
 If upgrading from GVP 7.0.3, browse and locate the following file:  
`<InstallDir>\sqlscripts\mssql\EventC\7.5.0\reporter_upgrade_7_5_0_from_7_0_3.sql`  
 If upgrading from GVP 7.2, browse and locate the following file:  
`<InstallDir>\sqlscripts\mssql\EventC\7.5.0\reporter_upgrade_7_5_0_from_7_2_0.sql`
9. Select and execute the file by pressing F5 or the execute icon.
10. Check for any errors.
11. Close the file.
12. Start the Reporter website.
13. Start the CallRecordsGenerator and Peaks Calculator processes (PeaksNSP, PeaksReporter, and PeaksAIM).

## Upgrading RepDWH Database

1. Stop the CallRecordsGenerator process.
2. Back up the RepDWH database.
3. Open the Query Analyzer.
4. Connect to the database server as RepDWH database user, using the source configuration information.
5. Point the Query Analyzer to the RepDWH database, if the Query Analyzer does not automatically find it.
6. Click the Load SQL Script icon on the SQL Query Analyzer.
7. If upgrading from VWAP 6.5.4, browse and locate the following file:  
`<InstallDir>\sqlscripts\mssql\EventC\7.5.0\repdwh_upgrade_7_5_0_from_6_5_4.sql` file.  
 If upgrading from GVP 7.0.3, browse and locate the following file:  
`<InstallDir>\sqlscripts\mssql\EventC\7.5.0\repdwh_upgrade_7_5_0_from_7_0_3.sql`  
 If upgrading from GVP 7.2, browse and locate the following file:  
`<InstallDir>\sqlscripts\mssql\EventC\7.5.0\repdwh_upgrade_7_5_0_from_7_2_0.sql`
8. Select and execute the file by pressing F5 or the execute icon. This might take some time to complete, depending upon the volume of data.
9. Check for any errors.
10. Close the file.
11. Start the CallRecordsGenerator process.

## Upgrading UnifiedLogin Database

1. Shut down the Login Server website.
2. Back up the UnifiedLogin database.
3. Open the Query Analyzer.
4. Connect to the database server as UnifiedLogin database user, using the source configuration information.
5. Point the Query Analyzer to the UnifiedLogin database, if the Query Analyzer does not automatically find it.
6. Click the Load SQL Script icon on the SQL Query Analyzer.
7. If upgrading from VWAP 6.5.4, browse and locate the following file:  
`<InstallDir>\sqlscripts\mssql\UnifiedLogin\7.5.0\UnifiedLogin_upgrade_7_5_0_from_6_5_4.sql`  
If upgrading from GVP 7.0.3, browse and locate the following file:  
`<InstallDir>\sqlscripts\mssql\UnifiedLogin\7.5.0\UnifiedLogin_upgrade_7_5_0_from_7_0_3.sql`  
If upgrading from GVP 7.2, browse and locate the following file:  
`<InstallDir>\sqlscripts\mssql\UnifiedLogin\7.5.0\UnifiedLogin_upgrade_7_5_0_from_7_2_0.sql`
8. Select and execute the file by pressing F5 or the execute icon. This produces some caution messages while executing; you can ignore these.
9. Check for any errors.
10. Close the file.
11. Start the Login Server website.

## Additional Database Maintenance Activities

### Cleaning Reporter Database

---

**Note:** The following steps are required only if upgrading from 6.5.4 to 7.5.

---

1. Stop the CallRecordsGenerator and Peaks Calculator processes.
2. Shut down the Reporter website.
3. Back up the Reporter database.
4. Open the Query Analyzer.
5. Connect to the database server as Reporter database user, using the source configuration information.
6. Point the Query Analyzer to the Reporter database, if the Query Analyzer does not automatically find it.

7. Click the Load SQL Script icon on the SQL Query Analyzer.
8. Browse and locate the <InstallDir>\sqlscripts\mssql\EventC\7.5.0\Cleanup\_Reporter\_7\_5\_0\_from\_6\_5\_4.sql file.
9. Select and execute the file by pressing F5 or the execute icon.
10. Check for any errors.
11. Close the file.
12. Start the Reporter website.
13. Start the CallRecordsGenerator and Peaks Calculator processes.

## Upgrading Reporter Queries

---

**Note:** The following steps are required only if upgrading from 6.5.4 to 7.5.

---

1. Stop the CallRecordsGenerator and Peaks Calculator processes.
2. Shut down the Reporter website.
3. Back up the Reporter database.
4. Open the Query Analyzer.
5. Connect to the database server as Reporter database user, using the source configuration information.
6. Point the Query Analyzer to the Reporter database, if the Query Analyzer does not automatically find it.
7. Click the Load SQL Script icon on the SQL Query Analyzer.
8. Browse and locate the <InstallDir>\sqlscripts\mssql\EventC\7.5.0\query\_upgrade\_reporter\_7\_5\_0\_from\_6\_5\_4.sql file.
9. Select and execute the file by pressing F5 or the execute icon.
10. Check for any errors.
11. Close the file.
12. Start the Reporter website.
13. Start the CallRecordsGenerator and Peaks Calculator processes.

## Cleaning RepDWH Database

---

**Note:** The following steps are required only if upgrading from 6.5.4 to 7.5.

---

1. Stop the CallRecordsGenerator process.
2. Back up the RepDWH database.
3. Open the Query Analyzer.

4. Connect to the database server as RepDWH database user, using the source configuration information.
5. Point the Query Analyzer to the RepDWH database, if the Query Analyzer does not automatically find it.
6. Click the Load SQL Script icon on the SQL Query Analyzer.
7. If upgrading to the 7.5 release from the 7.0.3 or the 6.5.4 release, browse and locate the <InstallDir>\sqlscripts\mssql\EventC\7.5.0\Cleanup\_RepDWH\_7\_5\_0\_from\_6\_5\_4.sql file.
8. Select and execute the file by pressing F5, or the execute icon. This might take some time to complete, depending upon the volume of data.
9. Check for any errors.
10. Close the file.
11. Start the CallRecordsGenerator process.

---

## Upgrade Considerations

This section provides recommendations for upgrading the GVP components in specific situations.

### EventC

#### EventC Standby Configuration

EventC does not support hot-standby; only cold-standby is supported. During the upgrade process, the EventC SQL database is replicated to the standby setup. The standby has EventC installed, but *not* running.

#### Key Changes to EventC

From 6.5.4 systems:

- Events Validator is removed.
- PeaksReporter and PeaksNSP are removed.
- EventCManager has been added to every box where EventsValidator previously existed.

#### Upgrade in a Primary-Standby Setup

Genesys recommends that you perform the upgrade by installing a standby GVP 7.5 system before installing the primary system. The reasons for this are:

- The installation of the upgraded standby system can be completed and tested without affecting the existing system.

- With a primary and a standby system available, the change to the upgraded version can be performed quickly, minimizing the time that the events need to be saved on the VCS/IPCS. Also, any hardware failure can be fixed by switching to the standby system.

## Policy Manager

### Upgrading Policy Manger in Real-Time

The following steps describe how to upgrade Policy Manager (PM) while processing calls:

1. Using EMPS, provision a customer on the GVP 7.5 PM server.
2. Start WatchDog. Ensure that the Element Management System (EMS) GUI for the GVP 7.5 PM server displays the newly provisioned PM customer.
3. Monitor the GVP 7.5 PM to ensure that calls are being processed correctly.
4. If calls are not being processed correctly by the new GVP 7.5 PM, direct traffic back to the existing GVP/VWAP PM, and then call Genesys Technical Support for troubleshooting the GVP 7.5 PM issue.
5. Once the new GVP 7.5 PM is handling traffic correctly, start upgrading other PM processes from the existing GVP/VWAP to GVP 7.5 as follows:
  - Re-provision each customer process to use the new GVP 7.5 PM server as the primary PM machine.
6. Monitor the GVP 7.5 PM server for several days. If any problems are found, roll-back to the original PM by re-provisioning all customers to the original PM process.

### Upgrading a Primary and Backup Policy Manager

The following steps describe how to upgrade a primary PM and a backup PM:

1. Upgrade the backup PM server before attempting to upgrade the primary PM.

---

**Note:** Direct all traffic handled by the backup PM to the primary PM before upgrading the backup PM.

---

2. Once the backup PM is idle, using the GDT, upgrade the PM and register it with the GVP 7.5 EMPS.
3. Using EMPS, provision a customer on the GVP 7.5 PM who is equivalent to a customer that exists on the primary PM.
4. Start WatchDog. Ensure that the EMS GUI for the PM server displays the newly provisioned PM customer.

5. If Step 4 was successful, direct traffic from the PM to the primary GVP 7.5 PM.
6. Monitor the GVP 7.5 PM to ensure that calls are being processed correctly.
7. If calls are not being processed correctly by the new GVP 7.5 PM, direct traffic back to the primary PM, and then call Genesys Technical Support for troubleshooting the GVP 7.5 PM issue.
8. Once it has been determined that the new GVP 7.5 PM is handling traffic correctly, start migrating other customer PM processes to GVP 7.5 as follows:  
Re-provision each customer process to use the new GVP 7.5 PM server as the primary PM machine.
9. Monitor the GVP 7.5 PM server for several days.
10. Once the GVP 7.5 PM server is fully functional, the primary PM server should then be upgraded to the GVP 7.5 PM software, following Steps 1–9.

## Bandwidth Manager

### Upgrading Bandwidth Manager in Real-Time

The following steps describe how to upgrade Bandwidth Manager (BWM) while processing calls:

1. Start WatchDog. Ensure that the EMS GUI for the BWM server displays the BWM process.
2. If Step 1 was successful, direct traffic for one provisioned customer from the previous version of BWM to the GVP 7.5 BWM.
3. Monitor the GVP 7.5 BWM to ensure that calls are being processed correctly on this server.
  - a. If calls are not being processed correctly by the new GVP 7.5 BWM, redirect traffic back to the previous BWM, and then call Genesys Technical Support for troubleshooting the GVP 7.5 BWM issue.
  - b. If the new GVP 7.5 BWM is handling traffic correctly, start migrating other customer BWM processes from the previous BWM to GVP 7.5, by re-provisioning each customer to use the new GVP 7.5 BWM server.
4. Monitor the GVP 7.5 BWM server for several days. If any issues are found, roll-back to the previous version, re-provisioning all customers to the previous process.

## IVR Server Client

### Upgrading IVR Server Client in Real-Time

The following steps describe how to upgrade IVR Server Client while processing calls:

1. Using EMPS, provision a customer on the GVP 7.5 IVR Server Client who is equivalent to a customer that exists on the original IVR Server Client.
2. Start WatchDog. Ensure that the EMS GUI for the IVR Server Client displays the newly provisioned IVR Server Client, as well as the connections to any provisioned IVR Servers.
3. If Step 2 was successful, redirect traffic for one provisioned customer from the original IVR Server Client to the GVP 7.5 IVR Server Client.
4. Monitor the GVP 7.5 IVR Server Client to ensure that calls are being processed correctly on this server.
  - a. If calls are not being processed correctly by the new GVP 7.5 IVR Server Client, redirect traffic back to the original IVR Server Client, and then call Genesys Technical Support for troubleshooting the GVP 7.5 IVR Server Client issue.
  - b. If the new GVP 7.5 IVR Server Client is handling traffic correctly, start migrating other customer IVR Server Client processes to GVP 7.5 as follows:

Re-provision each customer process to use the new GVP 7.5 IVR Server Client server as the primary IVR Server Client machine.
5. Monitor the GVP 7.5 IVR Server Client for several days to ensure that calls are being processed correctly. If any issues are found, roll-back to the original IVR Server Client by re-provisioning all customers to the original IVR Server Client process.

### Upgrading a Primary and Backup IVR Server Client

Genesys recommends the following steps for upgrading a primary and backup IVR Server Client:

1. Install the GVP 7.5 IVR Server Client on the new primary and backup servers using the GDT, and register them with the GVP 7.5 EMPS.
2. Using EMPS, provision a single customer to use the new GVP 7.5 IVR Server Clients who is equivalent to one that already exists on the original primary IVR Server Client.
3. Start WatchDog. Ensure that the EMS GUI for the IVR Server Client server displays the newly provisioned IVR Server Client customer, as well as the connections to any provisioned IVR Servers.

4. If Step 3 was successful, redirect traffic for the provisioned customer from the original IVR Server Client to the GVP 7.5 IVR Server Client.
5. Monitor the GVP 7.5 IVR Server Client for several days to ensure that calls are being processed correctly.
  - a. If calls are not being processed correctly by the new GVP 7.5 IVR Server Client, redirect traffic for that customer back to the original IVR Server Client, and then call Genesys Technical Support for troubleshooting the GVP 7.5 IVR Server Client issue.
  - b. If the new GVP 7.5 IVR Server Client is handling traffic correctly, start migrating other customer IVR Server Client processes to GVP 7.5 as follows:

Re-provision each customer process to use the new GVP 7.5 IVR Server Client server as the primary IVR Server Client machine.
6. Monitor the GVP 7.5 IVR Server Client server for several days. If any issues are found, roll-back to the original IVR Server Client by re-provisioning all customers to the original IVR Server Client process. Contact Genesys Technical Support to troubleshoot the issue on the GVP 7.5 IVR Server Client.

## Cisco Queue Adapter

### Upgrading Cisco Queue Adapter in Real-Time

The following steps describe how to upgrade the Cisco Queue Adapter (CQA) while processing calls:

1. Using EMPS, provision a customer on the GVP 7.5 CQA who is equivalent to a customer that exists on the original CQA.
2. Start WatchDog. Ensure that the EMS GUI for the CQA displays the newly provisioned CQA.
3. If Step 2 was successful, redirect traffic for one provisioned customer from the original CQA to the GVP 7.5 CQA as follows:
  - a. Provision the new GVP 7.5 CQA as the primary CQA.
  - b. Add the new GVP 7.5 CQA IP address to the Peripheral Gateway.
4. Monitor the GVP 7.5 CQA to ensure that calls are being processed correctly.
  - a. If calls are not being processed correctly by the new GVP 7.5 CQA, redirect traffic for that customer back to the original CQA, and then contact Genesys Technical Support for troubleshooting the GVP 7.5 CQA issue.
  - b. If the new GVP 7.5 CQA is handling traffic correctly, start migrating other customer CQA processes to GVP 7.5 as follows:



Re-provision each customer process to use the new GVP 7.5 CQA server as the primary CQA machine.

5. Monitor the GVP 7.5 CQA server for several days. If any issues are found, roll-back to the original CQA by re-provisioning all customers to the original CQA process.

## Upgrading a Primary and Backup CQA

Genesys recommends the following steps for upgrading the CQA:

---

**Note:** Upgrade the backup CQA first before attempting to upgrade the primary CQA.

---

1. Ensure that any traffic that the backup CQA is handling directly is diverted to the primary CQA.
2. Once the backup CQA is idle, using the GDT, install the GVP 7.5 CQA on the backup server, and register it with the GVP 7.5 EMPS.
3. Using EMPS, provision a customer on the GVP 7.5 CQA equivalent to a customer that exists on the original primary CQA.
4. Start WatchDog. Ensure that the EMS GUI for the CQA server displays the newly provisioned CQA customer.
5. If Step 4 was successful, redirect traffic for the provisioned customer from the original primary CQA to the primary GVP 7.5 CQA by provisioning the new GVP 7.5 CQA as the primary CQA process for the customer.
6. Monitor the GVP 7.5 CQA for several days to ensure that calls are being processed correctly.
  - a. If calls are not being processed correctly by the new GVP 7.5 CQA, redirect traffic for that customer back to the original CQA, and then contact Genesys Technical Support for troubleshooting the GVP 7.5 CQA issue.
  - b. If the new GVP 7.5 CQA is handling traffic correctly, start migrating other customer CQA processes to GVP 7.5 as follows:

Re-provision each customer process to use the new GVP 7.5 CQA server as the primary CQA machine.
7. Monitor the GVP 7.5 CQA server for several days. If any issues are found, roll-back to the original CQA process by re-provisioning all customers to the original CQA process.
8. Once the GVP 7.5 CQA server is fully functional, the original primary CQA server should then be upgraded to the GVP 7.5 CQA software following Steps 1–7.

## Configuring ASR Log Manager for MRCP

Some Media Resource Control Protocol (MRCP) Automatic Speech Recognition (ASR) vendors may require IPCS/VCS to send vendor specific parameters to enable integration to ASR Log Manager so that utterances are enabled/disabled correctly for each call.

Table 165 lists the EMPS parameters for VCS/IPCS.

**Table 165: EMPS Parameters**

| Location                                                                                            | EMPS Parameter Description | Type   | Description                                                                                                            | Default Values | Display Mode |
|-----------------------------------------------------------------------------------------------------|----------------------------|--------|------------------------------------------------------------------------------------------------------------------------|----------------|--------------|
| VCS:<br>Popgateway/ASR/MRCP<br>IPCS (basic):<br>McuXml/ASR/MRCP<br>IPCS (enhanced):<br>Mcu/ASR/MRCP | Enable Utterance Capture   | String | Specifies a string containing the vendor specific parameter to be sent to the server that turns on utterance capture.  | N/A            | Advanced     |
| VCS:<br>Popgateway/ASR/MRCP<br>IPCS (basic):<br>McuXml/ASR/MRCP<br>IPCS (enhanced):<br>Mcu/ASR/MRCP | Disable Utterance Capture  | String | Specifies a string containing the vendor specific parameter to be sent to the server that turns off utterance capture. | N/A            | Advanced     |

When using ASR Log Manager with SWMS:

1. Set the Enable Utterance Capture parameter to `swirec_suppress_waveform_logging=0`.
2. Set the Disable Utterance Capture parameter to `swirec_suppress_waveform_logging=1`.

---

**Note:** Utterance capture is set by default to `off` during ASR Log Manager installation.

---

3. Set the following parameters for the OSR baseLine.xml file in the directory Program Files\SpeechWorks\OpenSpeech Recognizer\config:

```
<param name="swiep_suppress_waveform_logging">
 <value>1</value>
</param>
<param name="swirec_suppress_waveform_logging">
 <value>1</value>
</param>
```

## Call Manager (SIP)

### New in GVP 7.5 IPCM

#### Content

In VWAP 6.5.4, the Call Manager components are part of the Voice Web Manager installation. In GVP 7.5, the IP Call Manager (IPCM) components have separate installers, one for each component listed below:

- Resource Manager (RM)
- SIP Session Manager (SSM)
- H.323 Session Manager (HSM)

#### Database

In VWAP 6.5.4, Call Manager uses the Microsoft SQL Server 2000 Database. Starting with GVP 7.0.3, Call Manager uses a Polyhedra real-time in-memory database. Use of the Polyhedra database continues in GVP 7.5.

---

**Note:** Using the PolyHedra database with fault tolerance is not applicable for HSM.

---

#### Device Status Polling

This is a new feature for GVP 7.5. IPCM periodically checks the health of each IPCS or Media Gateway (MG), and marks the device as available or unavailable accordingly. To achieve this, IPCM periodically sends a SIP message (with a timeout value) to each device. Based on the response, IPCM marks the status of each device as either available, or unavailable. Resource Manager does not reserve resources from an unavailable device.

### Upgrade Plan: Two New Servers

The following upgrade plan assumes that a fully redundant IPCM pair will be running. Traffic will be diverted to the new IPCM pair. Calls with limited

traffic will be made to verify the correct operation of the system before moving a full traffic load to the new system. This operation requires two new servers.

### Installing GVP 7.5 Software on Server1 and Server2

---

**Note:** The same versions of software should be installed on both servers.

---

- ♦ Using the GDT, install GVP 7.5 IPCM on two new servers.

### Configuring EMPS

To run the two IPCMs in a two-machine, fault-tolerant mode, perform the following steps in EMPS:

#### Call Manager Server1

1. On the Arbitrator page, specify the backup database address (Server2).
2. On the SIP Session Manager page, provide:
  - a. The primary database address and port. (For example, localhost:16500).
  - b. The backup database address and port. (For example, <server2>:16500).
3. On the Resource Manager page, provide:
  - a. The primary database address and port. (For example, localhost:16500).
  - b. The backup database address and port. (For example, <server2>:16500).
4. On the Resource Manager page, add the MG Server groups that will be used. For MG and MG Server group configuration, see the *Genesys Voice Platform 7.5 Deployment Guide*.

#### Call Manager Server2

1. On the Arbitrator page, specify the backup database address (Server1).
2. On the SIP Session Manager page, provide:
  - a. The primary database address and port. (For example, localhost:16500).
  - b. The backup database address and port. (For example, <server1>:16500).
3. On the Resource Manager page, provide:
  - a. The primary database address and port. (For example, localhost:16500).
  - b. The backup database address and port. (For example, <server1>:16500).
4. On the Resource Manager page, add the MG Server groups that will be used. Genesys recommends using the same MG Server groups as those configured for Server1. For MG and MG Server group configuration, see the *Genesys Voice Platform 7.5 Deployment Guide*.

### Load Sharing

After installation and configuration are complete, move five percent of the existing traffic to the new GVP 7.5 IPCM pair. One or more IPCSs should be registered with the new IPCM pair to process calls. The safest way to do this is to upgrade one or more IPCS systems to GVP 7.5 and register it with the new IPCM, and then monitor the system. If no problems are found, gradually move the rest of the traffic to this GVP 7.5 IPCM pair. After all of the traffic has been re-directed to the new GVP 7.5 IPCM pair, take the old IPCM pair off-line. The IPCM pair may now be used to upgrade any additional IPCMs in your deployment.

### Upgrade Plan—One New Server

The one new server upgrade plan is similar to the upgrade plan with two new servers; however, there is only a primary IPCM. After a new IPCM has been installed, and all of the traffic is moved to it, the old IPCM can be shut down, upgraded, and introduced as the backup IPCM server.

### Load Sharing

After installation and configuration are complete, move a small percentage of the existing traffic to the new GVP 7.5 IPCM host. One or more IPCSs should be registered with the new IP Call Manager to process calls. There is no backup Call Manager; therefore, if the Call Manager is not responding, calls will not be answered. Monitor the system. If no problems are found, upgrade the original backup server to GVP 7.5 IPCM and move traffic to it. Finally, upgrade the original primary server to GVP 7.5.

---

**Note:** After upgrading the original backup server, use the fault-tolerant configuration steps outlined in the section “Configuring EMPS” on [page 984](#) above.

---

### Upgrade Plan—No New Server

In this scenario, upgrade the backup IPCM before you upgrade. Follow the steps below for upgrading the backup IPCM:

1. Move all call traffic from the Media Gateway/SoftSwitch to the backup IPCM. If the primary IPCM is unavailable while the backup IPCM is being upgraded, then outbound calls made by IPCS might fail.
2. Initiate a graceful shutdown of WatchDog on the backup IPCM. If calls are stuck, and shutdown has not occurred, then an ungraceful shutdown can be initiated through IPCM processes (SSM, HSM, or RM).

---

**Note:** IPCM releases prior to GVP 7.2 MR1 cannot perform a graceful shutdown without losing data. You must plan the upgrade so that there are no calls on SSM. When SSM is shut down, all calls will be lost.

---

3. Using the GDT, install GVP 7.5 RM and GVP 7.5 SSM.
4. Configure EMPS using the information in the section “Configuring EMPS” on [page 984](#).
5. Move five percent of the existing call traffic to the backup IPCM, and then monitor the system. If there are no issues, slowly increase the call traffic. If calls are not being processed correctly by the backup IPCM, restore the original configuration and contact Genesys Technical Support.
6. Restart all IPCSs in the network to register them with the backup IPCM.

---

**Note:** The IPCM fault tolerance feature will not work until the primary IPCM is upgraded to GVP 7.5.

---

#### To upgrade the primary IPCM:

1. Ensure that all of the call traffic coming from the Media Gateway/SoftSwitch is going to the backup IPCM.
2. Configure all IPCSs in the network with the backup IPCM operating as the primary IPCM. This is required to avoid IPCS from timing out when it contacts the primary IPCM for outbound calls.
3. Initiate a graceful shutdown of WatchDog on the primary IPCM. The IPCM will still process active calls, but will not accept any new calls. If calls are stuck, and shutdown can not occur, then an ungraceful shutdown can be initiated through IPCM processes (SSM, HSM, or RM).

---

**Note:** IPCM releases prior to GVP 7.2 MR1 cannot perform a graceful shutdown without losing data. You must plan the upgrade, so that there are no calls on SSM. When SSM is shut down, all calls will be lost.

---

4. Using the GDT, install GVP 7.5 RM and GVP 7.5 SSM.
5. Re-configure all IPCSs for the primary and backup IPCM information, and then restart all IPCS hosts in the network.

## Device Status Polling

The Device Status Polling feature is turned off by default and should only be turned on after all of the IPCM and IPCS boxes have been migrated to GVP 7.5.

---

**Warning!** This feature should not be enabled if SIP Server does not support the OPTIONS method.

---

Device Status Polling can be configured through EMPS. For more information, see the “Configuring Resource Manager” section of the *Genesys Voice Platform 7.5 Deployment Guide*.

---

## Upgrading from Windows 2000 to Windows 2003

Microsoft supports the upgrade from Windows 2000 to Windows 2003 server; however, Microsoft states that it might be safer to install a new operating system, and then reinstall the software.

### Upgrading GVP 7.5 on Windows 2000 to GVP 7.5 on Windows 2003

This upgrade requires that each server be gracefully shut down, upgraded, and then restored. The order of shut down is not important, except to make sure that when a server is gracefully shutdown, it is not actively participating in calls, or if it is active, that it has a working backup server in place to handle the calls while the upgrade is taking place.







## Chapter

# 56

## Migration for Genesys Voice Platform: Network Edition

This chapter discusses the preliminary migration procedures and the migration order for migrating from Voice Web Application Platform (VWAP) 6.5.4 to Genesys Voice Platform: Network Edition (GVP: NE) 7.0.3, and Genesys Voice Platform: Network Edition 7.2.

The sequence for performing this upgrade preserves your previous configurations; however, make sure that you back up existing configuration information to facilitate reconfiguration after migration and in case you must roll back the upgrade.

There are six main sections in this chapter:

- [Introduction, page 990](#)
- [Deployment Sequence, page 990](#)
- [Loading New MIB, page 991](#)
- [Upgrading EMPS, page 991](#)
- [Upgrading EMS1 Components, page 992](#)
- [Upgrading EMS2 Components, page 993](#)

---

**Note:** You must contact your Genesys representative for specific guidance and assistance with your migration strategy. With the assistance of your Genesys representative, you must create a plan for approaching the installation/migration, and you must customize the migration steps. There is no single method for migration.

---

---

## Introduction

This chapter uses a typical installation and configuration with the following physical servers:

- A physical server with Voice Platform Element Management Provisioning System (EMPS) deployed.

---

**Note:** EMPS was referred to as Voice Web Provisioning System or VWPS in the VWAP 6.5.4 release.

---

- A physical server with a subset of Genesys Voice Platform Element Management System (EMS) components deployed. This server will be referred to as EMS1.

---

**Note:** EMS was referred to as Voice Web Manager or VWM in the VWAP 6.5.4 release.

---

- A second physical server with the remaining subset of EMS components deployed. This server will be referred to as EMS2.
- One or more physical servers with Genesys Voice Platform Voice Communications Server (VCS) deployed.
- One or more physical servers with Genesys Voice Platform IP Communications Server (IPCS) deployed.

---

## Deployment Sequence

Before upgrading, ensure that all VWAP components work correctly under the current release. All GVP components must be running the GA versions. The post-GA hot fixes are optional for this upgrade. Do not mix configuration and troubleshooting of the base installation with the upgrade. The following sections describe the recommended sequence for upgrading the GVP: NE components.

---

**Note:** This chapter describes only the upgrade sequence and caveats related to it. Make sure that you thoroughly understand the migration instructions and requirements before attempting the migration. For each component, there can be dependencies to the Genesys Voice Platform Common component. Each component will specify the dependencies.

---

---

## Loading New MIB

Loading new MIBs ensures that any new traps, which the new GVP: NE 7.0.3 and 7.2 components generate, are properly represented in your Element Management system. If no Element Management system is deployed, this step does not apply. This step does not adversely impact existing 6.5.4 or 7.0.3 traps. Verify normal functioning of your Element Management system by ensuring that the Alarm Monitor continues to display traps.

---

## Upgrading EMPS

EMPS uses a SunOne Directory Server and an SQL Server to store its information. You do not have to manually modify the SunOne Directory Server software or change SQL Server tables or SQL Server software for the upgrade. Implement this step by strictly adhering to the following instructions:

### To upgrade EMPS:

1. Uninstall EMPS using the Windows Control Panel > Add/Remove Programs menus.
2. After uninstalling, reboot the machine.
3. Back up the SunOne Directory Server. Export the relevant root node data into an LDIF file. For details on how to do this, refer to *Appendix A* in the *Voice Web Application Platform 6.5 Deployment Guide*.
4. After backing up the directory server data, backup the data in the VWPS SQL Server database. Make sure that the backup contains the schema.

---

**Note:** You can use the data from this backup if you must roll back to the previous environment.

---

5. Install the 7.0.3 or 7.2 version of EMPS. For details on how to do this, refer to the *Genesys Voice Platform: Network Edition 7 Deployment Guide*, or the *Genesys Voice Platform: Network Edition 7.2 Deployment Guide*.
6. Restart WatchDog.
7. Configure EMPS. For details on how to do this, refer to the *Genesys Voice Platform: Network Edition 7 Deployment Guide* for version 7.0.3, or the *Genesys Voice Platform: Network Edition 7.2 Deployment Guide* for version 7.2.

The upgrade preserves your existing EMPS configuration. Verify that all parameter values are correct.

---

**Note:** Some parameters in 7.0.3 are new, and you must supply values for them.

---

8. Log in to EMPS and click *D i a g n o s t i c s*. Make sure that all of the diagnostic tests return success.
9. In case the installation is not successful, perform the following steps to roll back to the previous version of EMPS.
  - a. Restore the SunOne Directory Server data from backup (follow the instructions provided by SunOne).
  - b. Restore the EMPS database from the backup that was taken before starting the upgrade.
  - c. Uninstall EMPS 7.0.3, or EMPS 7.2.
  - d. Install VWPS 6.5.4, or EMPS 7.0.3 (from the previous product DVD).

If you are migrating from release 6.5.4 to release 7.2, you must delete the following data nodes manually:

1. EPMS > Servers > each SAP machine:
  - SAP
  - RequestHandler
  - PopGateway1

---

**Note:** Do not delete the PopGateway1 node if this is a VCS/IPCS machine.

---

2. EMPS > Servers > each ORL machine:
  - ORL

---

**Note:** This procedure will not remove the ServerType ORL and SAP from the servers data. In this case, the Network Management GUI may continue to assume that SAP and ORL are present.

---

## Upgrading EMS1 Components

A typical installation and configuration will have a physical server with a subset of EMS components deployed. This server will be referred to as EMS1. The typical EMS1 physical server hosts the following EMS components:

- Policy Manager
- IVR Server Client (previously referred to as Genesys Queue Adapter)
- Bandwidth Manager

You must upgrade all EMS components on an EMS server at the same time. Follow these instructions to upgrade the listed components for EMS1.

1. Make a note of all of the EMS components running on your EMS1 server.
2. Stop all EMS services on the EMS1 server.
3. Uninstall all of the VWAP 6.5.4 or GVP: NE 7.0.3 components from the EMS1 server and reboot the machine.
4. Install the 7.0.3, or 7.2 version of only those EMS components identified in Step 1. For details on how to do this, refer to the *Genesys Voice Platform: Network Edition 7 Deployment Guide*.
5. Start all of the EMS services and verify that the calls are working. To do this, make a call and verify that the Policy Manager Element Management GUI shows call activity.

---

## Upgrading EMS2 Components

---

**Note:** The first step while upgrading the EMS Reporting Software is uninstalling the existing software followed by installing the new software.

---

A typical installation and configuration will have a second physical server with the remaining subset of VWM components deployed. This server will be referred to as EMS2. The typical EMS2 physical server hosts the following EMS components:

- EventCollector
- Unified Login Server
- Reporter
- Call Status Monitor
- Network Monitor

---

**Note:** GVP: NE 7.0.3 and 7.2 have discontinued the use of ASR Log manager, SAP, and TQA.

---

## Migrating EventC and Reporting

The EventCollector (EventC) receives call events from multiple VCS servers and processes these events into Call Data Records (CDRs). EventC uses an SQL database server to store call events and processed CDRs. The procedures outlined here, allow the operator to migrate from VWAP 6.5.4 (source) to GVP: NE 7.0.3 or 7.2 (destination). A qualified database administrator must be consulted to properly transfer SQL data from one server to another.

---

**Note:** Before proceeding with any of the following steps, make a backup of the Collector, Reporter, RepDWH, Peaks, and UnifiedLogin databases. Also, make a backup of the required folders in the data directory after stopping WatchDog in the EventC server. After the migration is complete, place those backed-up folders in the appropriate places. Also, make a back up of the log folder for future reference.

---

## EventC Configurations

EventC can be deployed in multiple types of configurations for scaling purposes.

[Table 166](#) shows a single box solution.

**Table 166: Single Box Solution**

Server	Processes	Databases	Load
Eventc_one	BillingURL EventsLoader EventsValidator CallRecsGenerator PeaksNSP PeaksReporter PeaksAIM	Collector Peaks Reporter RepDWH	100%

[Table 167](#) shows a two-box solution. It takes the reporter database out of the first box, so the reporting load on the box is reduced.

**Table 167: Two-Box Solution**

Server	Processes	Databases	Load
Eventc_one	BillingURL EventsLoader EventsValidator CallRecsGenerator PeaksNSP PeaksReporter PeaksAIM	Collector Peaks	100%
Eventc_SQL		Reporter RepDWH	

Table 168 shows a three-box solution.

**Table 168: Three-Box Solution**

Server	Processes	Databases	Load
Eventc_one	BillingURL(1) EventsLoader(1) EventsValidator(1) CallRecsGenerator(1) PeaksNSP PeaksReporter PeaksAIM	Collector(1) Peaks	30%
Eventc_two	BillingURL(2) EventsLoader(2) EventsValidator(2) CallRecsGenerator(2)	Collector(2)	70%
Eventc_SQL		Reporter RepDWH	

Table 169 shows a four-box solution.

**Table 169: Four-Box Solution**

Server	Processes	Databases	Load
Eventc_one	BillingURL(1) EventsLoader(1) EventsValidator(1) CallRecsGenerator(1)	Collector(1)	50%
Eventc_two	BillingURL(2) EventsLoader(2) EventsValidator(2) CallRecsGenerator(2)	Collector(2)	50%
Eventc_three	PeaksNSP PeaksReporter PeaksAIM	Peaks	
Eventc_SQL		Reporter RepDWH	

## EventC Standby Configuration

EventC does not support hot-standby; only cold-standby. The EventC\_SQL database is replicated to the standby setup. The standby has EventC installed, but **not** running.

### Key Changes to EventC

- Events Validator is removed.
- PeaksReporter and PeaksAIM are removed.
- EventCManager has been added to every box where EventsValidator existed before.

## Migration Strategy

This section describes the sequence of actions to be executed to migrate EventC in various configurations. The instructions to execute individual steps are provided in the “Migration Instructions” on [page 997](#).

### Migration in a Primary-Standby Setup

Genesys recommends to migrate the standby setup first before migrating the primary.

### Migration Sequence

The sequence of operations below can be executed across a timeline of a few days (if desired) and the systems will be operational during the mixed-mode period.

1. Upgrade the Reporter database (instructions below).
2. Upgrade the RepDWH database (instructions below).
3. Upgrade the EventCs one-by-one.
  - a. Stop the EventC server (instructions below).
  - b. Uninstall the EventC software.
  - c. Log in to the EMPS GUI.
  - d. Select Server from the top pane, and then expand the Events Collector node on the left pane.
  - e. Expand the EventC Server node, and delete the following nodes:
    - CallRecsGenerator
    - EventsLoader
    - PeaksNSP
    - EventsValidator
    - PeaksCollector
    - PeaksAIM
    - PeaksReporter



- f. Install and set up the EventC software (for the instructions, refer to the *Genesys Voice Platform: Network Edition 7 Deployment Guide* for version 7.0.3, or the *Genesys Voice Platform: Network Edition 7.2 Deployment Guide* for version 7.2). For provisioning EventC, use the information noted from the prior version while stopping EventC.
  - g. Upgrade the Collector database (instructions below).
  - h. Upgrade the Peaks database if peaks is on this EventC (instructions below).
  - i. Start the EventC server (instructions below).
4. Upgrade the Reporter software.
    - a. Install the Reporter Software (for the instructions, refer to the *Genesys Voice Platform: Network Edition 7 Deployment Guide* for version 7.0.3, or *Genesys Voice Platform: Network Edition 7.2 Deployment Guide* for version 7.2).
    - b. Upgrade the reporter queries (instructions below).
  5. Clean up the Reporter database (instructions below).
  6. Clean up the RepDWH database (instructions below).
  7. Upgrade the Login server.
    - a. Stop the Login Server website.
    - b. Upgrade the UnifiedLogin database to version 7.0.3 (`UnifiedLogin_upgrade_7_0_3_from_6_5_4.sql`), or to version 7.2 (`UnifiedLogin_upgrade_7_2_from_7_0_3.sql`).
    - c. Install the Login Server software (for the instructions, refer to the *Genesys Voice Platform: Network Edition 7 Deployment Guide* for version 7.0.3, or the *Genesys Voice Platform: Network Edition 7.2 Deployment Guide* for version 7.2).
  8. Upgrade the Call Status Monitor software (for the instructions, refer to the *Genesys Voice Platform: Network Edition 7 Deployment Guide* for version 7.0.3, or *Genesys Voice Platform: Network Edition 7.2 Deployment Guide* for version 7.2).

## Migration Instructions

### Stopping an EventC Server

To migrate the EventC server from VWAP 6.5.4 to GVP: NE 7.0.3 or GVP: NE 7.2, follow these steps:

Take note of the provisioning information from the following sections of the current installation (source).

- `configeventc`
- `eventsloader`
- `callrecordsgenerator`

- peaksnsp

Stop the billing port (Port # =9810 / 9811) on the EventC server (source). This ensures that the VCS/IPCS can no longer send call events to the EventC server.

---

**Note:** The communication servers store these events locally on disk. Ensure that each individual communication server has sufficient disk space to store the call events generated during this cutover period. During this cutover period, the communication servers will send Billing data send failed SNMP traps to the Network Management Console.

---

Allow Events Loader on the EventC server (source) to run at least two cycles after the billing port (Port#=9810/9811) has been stopped. This ensures that all pending call-event data files in the Current Data directory are loaded into the SQL database on the old EventC server (source). Verify that there are no files left under the Current Data directory on the old EventC server (source) before proceeding to the next step.

If you still see some files, you can make a backup of them and move them manually to the corresponding directory on the newer version installation. Also, make a backup of the cn\data\archives and cn\data\exceptions directories. Place them manually on the corresponding directory on the migrated version installation. Make a backup of the log folder for future reference.

### Starting an EventC Server

1. Start the Events Collector processes on the new EventC server (target). Ensure that all EventC processes are functioning correctly. Examine EventC log files to ensure that there are no database connectivity issues or other errors.
2. Closely monitor the logs for the EventC processes on the EventC server (target) for problems. Also verify that the Reporter GUIs are showing new calls.
3. Start the billing port on the new EventC server (target).
4. Check the Current Data directory on the new EventC server (target). There should be directories created for each communication server, and files received should also appear.

### Upgrading Network Monitor

1. Stop the Network Monitor.
2. Uninstall the Network Monitor software.
3. Install and setup Network Monitor software.
4. Upgrade Netmon Database.
5. Start the Network Monitor Server.

## Upgrade Network Monitor Database

1. Stop Network Monitor processes.
2. Back up the Network Monitor Database.
3. Open Query Analyzer.
4. Connect to the database server as the Collector database user. Use the source configuration information to do so.
5. Point the Query Analyzer to the Collector database if Query Analyzer does not do it automatically.
6. Click the Load SQL Script icon on the SQL Query Analyzer.
7. If upgrading to the 7.2 release from the 7.0.3 or the 6.5.4 release, browse and locate the  
`<InstallDir>\sqlscripts\mssql\7.2.0\netmon_upgrade_7_2_0_from_7_0_3.sql` file.  
If upgrading to the 7.0.3 release from the 6.5.4 release, browse and locate the  
`<InstallDir>\sqlscripts\mssql\7.0.3\netmon_upgrade_7_0_3_from_6_5_4.sql` file.
8. Select the file and execute the same by pressing F5, or the execute icon. This may take a while to complete depending upon the volume of data.
9. Check for any errors.
10. Close the file.
11. Start the Network Monitor processes.

## Upgrading Collector Database

1. Stop the Events Loader and Events Validator processes.
2. Back up the Collector database.
3. Open Query Analyzer.
4. Connect to the database server as Collector database user. Use the source configuration information to do so.
5. Point the Query Analyzer to the Collector database if the Query Analyzer does not do it automatically.
6. Click the Load SQL Script icon on the SQL Query Analyzer.
7. If upgrading to the 7.2 release from the 7.0.3 or the 6.5.4 release, browse and locate the  
`<InstallDir>\sqlscripts\mssql\EventC\7.2.0\collector_upgrade_7_2_0_from_6_5_4.sql` file.  
If upgrading to the 7.0.3 release from the 6.5.4 release, browse and locate the

<InstallDir>\sqlscripts\mssql\EventC\7.0.3\collector\_upgrade\_7\_0\_3\_from\_6\_5\_4.sql file.

8. Select and execute the file by pressing F5, or the execute icon. This might take some time to complete depending upon the volume of data.
9. Check for any errors.
10. Close the file.
11. Start the Events Loader and Events Validator processes.

## Upgrading Peaks Database

1. Stop the Call Records Generator and Peaks Calculator processes.
2. Back up the Peaks database.
3. Open the Query Analyzer.
4. Connect to the database server as Peaks database user. Use the source configuration information to do so.
5. Point the Query Analyzer to the Peaks database if Query analyzer does not do it automatically.
6. Click the Load SQL Script icon on the SQL Query analyzer.
7. If upgrading to the 7.2 release from the 7.0.3 or the 6.5.4 release, browse and locate the  
<InstallDir>\sqlscripts\mssql\EventC\7.2.0\peaks\_upgrade\_7\_2\_0\_from\_6\_5\_4.sql file.  
If upgrading to the 7.0.3 release, browse and locate the  
<InstallDir>\sqlscripts\mssql\EventC\7.0.3\peaks\_upgrade\_7\_0\_3\_from\_6\_5\_4.sql file.
8. Select and execute the file by pressing F5, or the execute icon.
9. Check for any errors.
10. Close the file.
11. Start the Call Records Generator and Peaks Calculator processes.

## Upgrading Reporter Database

1. Stop the CallRecordsGenerator and Peaks Calculator processes (PeaksNSP, PeaksReporter, and PeaksAIM).
2. Stop the Reporter website.
3. Back up the Reporter database.
4. Open the Query Analyzer.
5. Connect to the database server as Reporter database user. Use the source configuration information to do so.

6. Point the Query Analyzer to the Reporter database if the Query Analyzer does not do it automatically.
7. Click the Load SQL Script icon on the SQL Query analyzer.
8. If upgrading to the 7.2 release from the 7.0.3 or the 6.5.4 release, browse and locate the file  
`<InstallDir>\sqlscripts\mssql\EventC\7.2.0\reporter_upgrade_7_2_0_from_6_5_4.sql`.  
 If upgrading to the 7.0.3 release from the 6.5.4 release, browse and locate the  
`<InstallDir>\sqlscripts\mssql\EventC\7.0.3\reporter_upgrade_7_0_3_from_6_5_4.sql` file.
9. Select and execute the file by pressing F5, or the execute icon.
10. Check for any errors.
11. Close the file.
12. Start the Reporter website.
13. Start the CallRecordsGenerator and Peaks Calculator processes (PeaksNSP, PeaksReporter, and PeaksAIM).

## Upgrading RepDWH Database

1. Stop the CallRecordsGenerator process.
2. Back up the RepDWH database.
3. Open the Query Analyzer.
4. Connect to the database server as RepDWH database user. Use the source configuration information to do so.
5. Point the Query Analyzer to the RepDWH database if the Query Analyzer does not do it automatically.
6. Click the Load SQL Script icon on the SQL Query analyzer.
7. If upgrading to the 7.2 release from the 7.0.3 or the 6.5.4 release, browse and locate the  
`<InstallDir>\sqlscripts\mssql\EventC\7.2.0\repdwh_upgrade_7_2_0_from_6_5_4.sql` file.  
 If upgrading to the 7.0.3 release from the 6.5.4 release, browse and locate the  
`<InstallDir>\sqlscripts\mssql\EventC\7.0.0\repdwh_upgrade_7_0_3_from_6_5_4.sql` file.
8. Select and execute the file by pressing F5, or the execute icon. This might take some time to complete depending upon the volume of data.
9. Check for any errors.
10. Close the file.

11. Start the CallRecordsGenerator process.

## Upgrading UnifiedLogin Database

1. Stop the Login Server website.
2. Back up the UnifiedLogin database.
3. Open the Query Analyzer.
4. Connect to the database server as UnifiedLogin database user. Use the source configuration information to do so.
5. Point the Query Analyzer to the UnifiedLogin database if the Query Analyzer does not do it automatically.
6. Click the Load SQL Script icon on the SQL Query analyzer.
7. If upgrading to the 7.2 release from the 7.0.3 or the 6.5.4 release, browse and locate the  
`<InstallDir>\sqlscripts\mssql\UnifiedLogin\7.2.0\UnifiedLogin_upgrade_7_2_0_from_6_5_4.sql` file.  
If upgrading to the 7.0.3 release from the 6.5.4 release, browse and locate the  
`<InstallDir>\sqlscripts\mssql\UnifiedLogin\7.0.3\UnifiedLogin_upgrade_7_0_2_from_6_5_4.sql` file.
8. Select and execute the file by pressing F5, or the execute icon. This produces some “caution” messages while executing, which you can ignore.
9. Check for any errors.
10. Close the file.
11. Start the Login Server website.

## Cleaning Reporter Database

---

**Note:** This procedure is not required if upgrading to the 7.2 release from the 7.0.3 release.

---

1. Stop the CallRecordsGenerator and Peaks Calculator processes.
2. Stop the Reporter website.
3. Back up the Reporter database.
4. Open the Query Analyzer.
5. Connect to the database server as Reporter database user. Use the source configuration information to do so.
6. Point the Query Analyzer to the Reporter database if the Query Analyzer does not do it automatically.

7. Click the Load SQL Script icon on the SQL Query analyzer.
8. If upgrading to the 7.2 release from the 6.5.4 release, browse and locate the <InstallDir>\sqlscripts\mssql\EventC\7.2.0\Cleanup\_Reporter\_7\_2\_0\_from\_6\_5\_4.sql file.  
If upgrading to the 7.0.3 release from the 6.5.4 release, browse and locate the <InstallDir>\sqlscripts\mssql\EventC\7.0.3\Cleanup\_Reporter\_7\_0\_3\_from\_6\_5\_4.sql file.
9. Select and execute the file by pressing F5, or the execute icon.
10. Check for any errors.
11. Close the file.
12. Start the Reporter website.
13. Start the CallRecordsGenerator and Peaks Calculator processes.

## Upgrading Reporter Queries

1. Stop the CallRecordsGenerator and Peaks Calculator processes.
2. Stop the Reporter website.
3. Back up the Reporter database.
4. Open the Query Analyzer.
5. Connect to the database server as Reporter database user. Use the source configuration information to do so.
6. Point the Query Analyzer to the Reporter database if the Query Analyzer does not do it automatically.
7. Click the Load SQL Script icon on the SQL Query analyzer.
8. If upgrading to the 7.2 release from the 6.5.4 release, browse and locate the <InstallDir>\sqlscripts\mssql\EventC\7.2.0\query\_upgrade\_reporter\_7\_2\_0\_from\_6\_5\_4.sql file.  
If upgrading to the 7.0.3 release from the 6.5.4 release, browse and locate the <InstallDir>\sqlscripts\mssql\EventC\7.0.3\query\_upgrade\_reporter\_7\_0\_3\_from\_6\_5\_4.sql file.
9. Select and execute the file by pressing F5, or the execute icon.
10. Check for any errors.
11. Close the file.
12. Start the Reporter website.
13. Start the CallRecordsGenerator and Peaks Calculator processes.

## Cleaning RepDWH Database

1. Stop the CallRecordsGenerator process.
2. Back up the RepDWH database.
3. Open the Query Analyzer.
4. Connect to the database server as RepDWH database user. Use the source configuration information to do so.
5. Point the Query Analyzer to the RepDWH database if the Query Analyzer does not do it automatically.
6. Click the Load SQL Script icon on the SQL Query Analyzer.
7. If upgrading to the 7.2 release from the 7.0.3 or the 6.5.4 release, browse and locate the `<InstallDir>\sqlscripts\mssql\EventC\7.2.0\Cleanup_RepDWH_7_2_0_from_6_5_4.sql` file.  
If upgrading to the 7.0.3 release from the 6.5.4 release, browse and locate the `<InstallDir>\sqlscripts\mssql\EventC\7.0.3\Cleanup_RepDWH_7_0_3_from_6_5_4.sql` file.
8. Select and execute the file by pressing F5, or the execute icon. This might take some time to complete depending upon the volume of data.
9. Check for any errors.
10. Close the file.
11. Start the CallRecordsGenerator process.

## Upgrading Voice Platform Call Manager

A typical installation and configuration will have a third physical server with the following Call Manager components:

- Resource Manager
  - SIP Session Manager or H323 Session Manager
1. If the configuration has a primary and a backup Call Manager, first upgrade the primary Call Manager. Before the upgrade, reconfigure the SoftSwitch/Media Gateways to route all new calls to the backup Call Manager.
  2. Make a note of all of the Call Manager components running on your current Call Manager server.
  3. Stop all EMS services, including IIS.

---

**Warning!** This action disconnects all active calls.

---

4. Uninstall all of the VWAP 6.5.4 or GVP:NE 7.0.3 components from this server and reboot the machine.



5. Install all of the 7.0.3, or 7.2 versions of only those Call Manager components identified in Step 2 of this section. For details, follow the instructions in the *Genesys Voice Platform: Network Edition 7 Deployment Guide* for version 7.0.3, or the *Genesys Voice Platform: Network Edition 7.2 Deployment Guide* for version 7.2.
6. Start all of the EMS services and verify that the calls are working. To do this:
  - a. Configure a test number in the SoftSwitch/Media Gateway to route calls to this Call Manager server.
  - b. Verify that the call is answered and audio is established.
7. Reconfigure the SoftSwitch/Media Gateways to route all new calls to this server.
8. Follow steps 2–6 to upgrade the backup Call Manager.

## Upgrading VCS

Genesys recommends that you upgrade one VCS machine in the network, verify that the new software is working, and then upgrade the remaining VCS machines.

1. Gracefully shut down the WatchDog on the VCS machine.
2. Uninstall the VCS software. Completely remove the `cn/` tree—for example, `c:/cn` or `d:/cn`.

---

**Notes:** If you are migrating from VCS 6.5.4 (Dialogic 5.1.1) and have custom patches, features, or parameters configured by Intel/Dialogic, you must work with Intel/Dialogic to ensure that these items are available in the Dialogic SR 6.0 release, and you must obtain the procedures for propagating these changes before beginning migration from VCS 6.5.4 to 7.2.0.

If you are migrating from VCS 6.5.4 (Dialogic 5.1.1), follow step 3; otherwise, proceed to step 4.

---

3. Uninstall Dialogic by following these steps:
  - a. Backup the `%dialogic%\data` and `%dialogic%\cfg` directories, where `%dialogic%` is the Dialogic install directory. These may be needed when working with Intel/Dialogic to migrate to SR 6.0.
  - b. Uninstall the Dialogic PTRs:
    - Run the uninstall program from Start > Programs > Intel Dialogic System Software > Point Release > Point Release Uninstall.
    - Click OK when prompted to confirm the uninstall.
    - If prompted to remove shared files, click Yes to All.

- When prompted to reboot the machine, click **Yes** in order to complete the package uninstallation.
  - c. Uninstall the Global Call Protocols 4.0:
    - Go to **Add/Remove Programs**.
    - Select **Intel Dialogic Global Call Protocols** from the list of currently installed programs.
    - Click **Remove**.
    - Click **OK** when prompted to confirm the uninstall.
    - Click **Yes** when prompted to reboot the machine. This completes the uninstallation for this package.
  - d. Uninstall Dialogic Service Pack 1:
    - Run the **System Release 5.1.1 Service Pack 1 Uninstall program** from **Start > Programs > Intel Dialogic System Software**.
    - Click **Yes** when prompted to confirm the uninstall.
    - If prompted to remove shared files, click **Yes to All**.
    - When prompted to reboot the machine, click **Yes** in order to complete the package uninstallation.
  - e. Uninstall Dialogic System Release:
    - Run the uninstall program from **Start > Programs > Intel Dialogic System Software**.
    - Click **OK** when prompted to confirm the uninstall.
    - If prompted to remove shared files, click **Yes to All**.
    - When prompted to reboot the machine, click **Yes** in order to complete the package uninstallation.
    - Delete the **Dialogic Installation** directory. This removes the files that were created for automated configuration.
4. Install Dialogic SR 6.0 SU 65 by following the instructions in the *Genesys Voice Platform 7.2 Dialogic Deployment Guide*.

---

**Note:** If you are migrating from VCS 7.0.3 (Dialogic SR 6.0) and you are already using Dialogic System Release 6.0, VCS 7.2.0 supports SR 6.0 SU 65. Uninstall SR 6.0, and then follow the instructions in the *Genesys Voice Platform 7.2 Dialogic Deployment Guide* to install Dialogic SR 6.0 SU 65. This is the same as a new Dialogic installation, and the necessary files will be updated.

---

5. Install the 7.0.3, or 7.2 VCS. Follow the instructions in the *Genesys Voice Platform: Network Edition 7 Deployment Guide* for version 7.0.3, or the *Genesys Voice Platform: Network Edition 7.2 Deployment Guide* for version 7.2, to install and configure the VCS software.
6. Start WatchDog. Make calls and verify that the calls are working as expected.

## Upgrading IPCS

Genesys recommends that you upgrade one IPCS machine in the network, verify that the new software is working, and then upgrade the remaining IPCS machines.

1. Gracefully shut down the WatchDog on the IPCS machine.
2. Uninstall the IPCS software. Completely remove the `cn/` tree—for example, `c:/cn` or `d:/cn`.
3. Install the 7.0.3, or 7.2 IPCS. Follow the instructions in the *Genesys Voice Platform: Network Edition 7 Deployment Guide* for version 7.0.3, or the *Genesys Voice Platform: Network Edition 7.2 Deployment Guide* for version 7.2 to install and configure the IPCS software.
4. Start WatchDog. Make calls, and verify that the calls are working as expected.

## Upgrading TTS

---

**Notes:**

- GVP: NE 7.0.3 supports Speechify 3.x version. If you have Speechify 2.x, you must first upgrade to Speechify 3.x, using ScanSoft's instructions.
- GVP: NE 7.2 supports only MRCP TTS. If you have non MRCP TTS software, you must upgrade to MRCP TTS.

- 
1. Gracefully shut down the WatchDog on the TTS machine.
  2. Uninstall the TTS software. Completely remove the `cn/` tree—for example, `c:/cn` or `d:/cn`.
  3. Install the TTS software. Follow the instructions in the *Genesys Voice Platform: Network Edition 7 Deployment Guide* for version 7.0.3.
  4. Start WatchDog. Make calls and verify that TTS requests are being processed as expected.

## Upgrading to MRCP TTS

To upgrade to MRCP TTS, install the MRCP server software using the vendor's instructions. Consult the MRCP vendor for details. On the IPCS/VCS servers, remove all groups from the Primary TTS Server Groups and Backup TTS Server Groups under PopGateway section(s) for VCS, or McuXml for IPCS. Also, you must uninstall the non MRCP TTS software. When the uninstall is complete, install and configure the 7.2 TTS MRCP client software

by following the instructions in the *Genesys Voice Platform: Network Edition 7.2 Deployment Guide*.

## Upgrading ASR

To upgrade to MRCP ASR, install the MRCP server software using the vendor's instructions. Confidence scores from applications might need to be recalibrated. Consult the MRCP vendor for details.

---

**Note:** GVP: NE 7.0.3 and 7.2 does not support non-MRCP ASR. If you are running a 6.5.4 non-MRCP ASR release, Genesys recommends that you upgrade the MRCP to the 6.5.4 release first before migrating to 7.2.

---

MRCP ASR provides results in NLSML format. This may impact the application if you are upgrading to MRCP where your previous ASR platform provided results in a non-NLSML format. Work with your ASR vendor to resolve these differences.

## Upgrade Considerations for Voice Applications

VWAP 6.5.4 supports W3C VoiceXML 2.0 CR (Candidate Release) and GVP 7.0.3 as well as GVP 7.2 supports W3C VoiceXML 2.0 R (Recommendation). GVP 7.2 supports W3C VoiceXML 2.1 (Candidate Recommendation).

The major changes from VoiceXML 2.0 CR include:

- References to <sentence> and <paragraph> elements are no longer included in SSML.
- The first grammar in document order has highest priority if the input matches more than one active grammar with the same precedence.

---

**Note:** If these changes impact your application, you must upgrade it to the latest version.

---



## Chapter

# 57

## Migration for Genesys Voice Platform: Enterprise Edition

This chapter provides information on how to migrate the Genesys Voice Platform: Enterprise Edition (GVP: EE) from GVP: EE 6.5.5, GVP: EE 7.0.2, or GVP: EE 7.0.3 to GVP: EE 7.2. The sections in this chapter are presented in the order you must upgrade the GVP: EE components:

- [Migration Strategy, page 1009](#)
- [Migrating Third-Party Software, page 1010](#)
- [Migrating GVP: EE using Solution Installer, page 1012](#)
- [Migrating GVP: EE without Solution Installer, page 1023](#)

---

### Migration Strategy

The GVP 7.2 Solution Installer provides a Migration Wizard that will help you migrate GVP: EE 6.5.5, GVP: EE 7.0.2 and GVP: EE 7.0.3 configuration to GVP: EE 7.2. However the following limitations exist:

- If the previous GVP: EE release was configured manually, or you were using features that are no longer supported in GVP 7.2, you can either do a manual migration without using the Solution Installer (see “Migrating GVP: EE without Solution Installer” on [page 1023](#)) or you can use the Solution Installer to do a software update with no changes to the configuration (see “Migrating when Previous Deployment was Manually Installed” on [page 1021](#)).

- If you are using non-Media Resource Control Protocol (MRCP) speech engines, you can still use the migration wizard to upgrade, but you will have to configure new Automatic Speech Recognition (ASR) and Text-to-Speech (TTS) features. Refer to “Migrating Third-Party Software” on [page 1010](#) for further details.

---

## Migrating Third-Party Software

The third-party software described in the following sections should be upgraded. For further information on these products, consult your vendor.

### Migrating from OSR to MRCP ASR

#### Uninstalling OSR 1.1.4/2.0

1. Go to Control Panel > Administrative Tools > Services, stop the WatchDog service and set the service Startup type to Manual.
2. Uninstall SpeechWorks OSR 1.1.4/2.0 using Add/Remove Programs.
3. Backup existing license file.
4. Restart the computer.
5. Delete the existing SpeechWorks directory.
6. Restart the computer.

#### Upgrading to MRCP ASR

To upgrade to MRCP ASR, install the MRCP server software using the vendor's instructions. Confidence scores from applications may need to be recalibrated. Consult the MRCP vendor for details.

---

**Note:** If upgrading from OSR to MRCP ASR, change the Applications' ASR type in VPM.

---

### Migrating from Speechify to MRCP TTS

#### Uninstalling Speechify 2.1.6/3.0.2

1. Go to Control Panel > Administrative Tools > Services, stop the WatchDog service, and set the service Startup type to Manual.
2. Uninstall Speechify 2.1.6/3.0.2 voice fonts using Add/Remove Programs.
3. Uninstall Speechify 2.1.6/3.0.2 software using Add/Remove Programs.

4. Restart the computer.

## Upgrading to MRCP TTS

To upgrade to MRCP TTS, install the MRCP server software using the vendor's instructions. Consult the MRCP vendor for details.

---

**Note:** If upgrading from Speechify to MRCP TTS, change the TTS Vendor in VPM.

---

## Migrating from RealSpeak to MRCP TTS

### Uninstalling RealSpeak 3.5

1. Go to Control Panel > Administrative Tools > Services, stop the WatchDog service, and set the service Startup type to Manual.
2. Uninstall RealSpeak 3.5 using Add/Remove Programs.
3. Restart the computer.

### Upgrading to MRCP TTS

To upgrade to MRCP TTS, install the MRCP server software using the vendor's instructions. Consult the MRCP vendor for details.

## Upgrading Dialogic

If you are migrating from GVP 7.0.2 or GVP 7.0.3 and you are already using Dialogic System Release 6.0, uninstall SR 6.0 and then follow the instructions in the *Genesys Voice Platform 7.2 Dialogic Deployment Guide* to install Dialogic SR 6.0 SU 6.5. Otherwise, perform the following steps:

1. Stop Watchdog and set the service Startup type to Manual through Control Panel > Administrative Tools > Services > Watchdog.
2. Save your Dialogic configuration files from your previous GVP: EE install. They are usually in the Dialogic\cfg and Dialogic\data folders, but you must verify with Intel/Dialogic to determine the exact paths.
3. Upgrade the Dialogic Software from SR 5.1.1 to SR 6.0 using the following steps:
  - a. Uninstall all Dialogic PTRs using Add/Remove Programs.
  - b. Uninstall Dialogic Global Call Protocols using Add/Remove Programs.
  - c. Uninstall Dialogic Server Pack using Add/Remove Programs.
  - d. Uninstall Dialogic System Release from Start > Programs > Intel>Dialogic System Software.

- e. Install Dialogic 6.0 as specified in the *Genesys Voice Platform 7.2 Dialogic Deployment Guide*.
4. Work with Intel/Dialogic to convert Dialogic configuration files from SR 5.1.1 to SR 6.0. It is necessary to involve Intel/Dialogic in this step because the name and format of the files has changed from SR 5.1.1 to SR 6.0. At the end of this step, you should be able to establish communication between the Dialogic board and the Private Branch Exchange (PBX)/Telecom switch using the Dialogic Configuration Manager (DCM) and Intel diagnostics software without involving GVP software.

---

## Migrating GVP: EE using Solution Installer

The following information pertains to migrating GVP: EE using the GVP Solution Installer.

### Migrating when GVP:EE was previously installed

When migrating GVP: EE when previously installed using Solution Installer or GVP Configurator, use this section. This section describes how to use the Genesys Voice Platform Solution Installer to upgrade versions (6.5.5, 7.0.2, 7.0.3) of GVP: EE that have been installed using either the Solution Installer or the GVP Configurator.

The Solution Installer will run through the setup and will default to the pre-selected configurations of the prior GVP installation. However, this does not restrict you to manually setup a new configuration during the upgrade. You are free to make configuration changes to the new version of the GVP software.

The Solution Installer enables you to either upgrade, update or uninstall the currently installed version of GVP: EE.

The `Upgrade` option will migrate the DataStore, allow you to step through the configuration screens to confirm/change configuration information, uninstall the existing GVP: EE software, and install the current GVP: EE 7.2 software.

The `Update` option will enable you to make a quick upgrade without making any configuration changes. This option will migrate the DataStore, uninstall all components not supported by GVP: EE 7.2 and then will install/upgrade the previously installed components which are supported by GVP: EE 7.2.

The `Uninstall` option uninstalls all the installed GVP: EE components.

Below is an upgrade scenario of a Single box IP Telephony implementation using the GVP 7.2 Solution Installer. Screens will vary depending on your implementation and on the Features configured.



---

**Notes:**

- If you plan on upgrading GVP: EE, you must first stop the WatchDog service before launching the solution installer.
  - If the installation is TDM-based, you must stop the Intel Dialogic System Service.
  - Genesys does not recommend installation of its components through a Microsoft Remote Desktop connection. The installation should be performed locally.
- 

In this upgrade example, TTS, ASR and IVR Server Client will be selected.

1. Insert the Genesys Voice Platform: Enterprise Edition DVD on an older pre-existing GVP installed machine.
2. Go to the <GVP CD directory> \solution\_specific \windows \install \ folder and double click the setup.bat file. The GVP: EE Solution Installer Maintenance screen opens (see [Figure 44](#)).

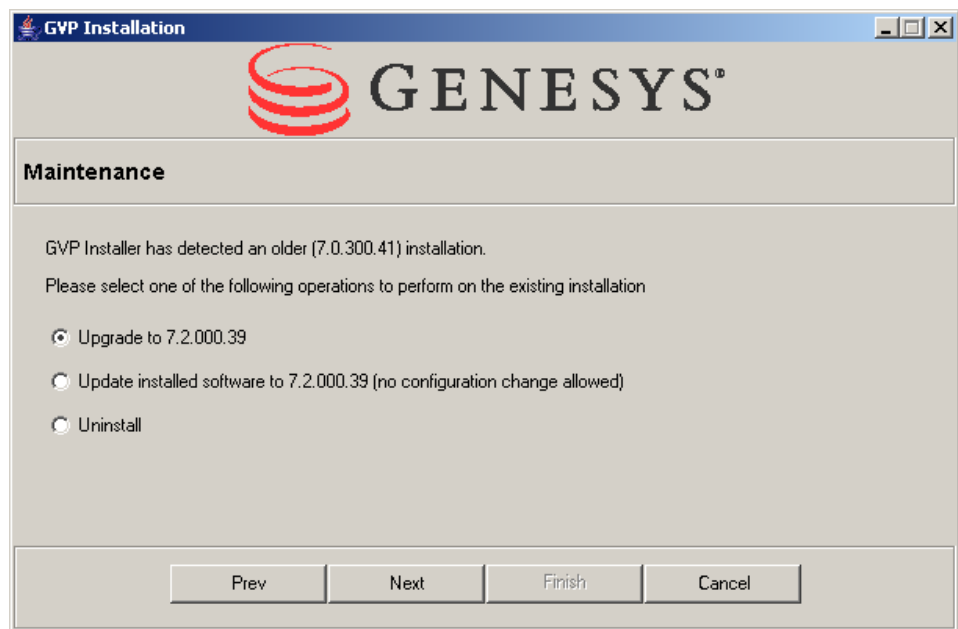

**Figure 44: Maintenance Screen**

3. Select Upgrade to... and click Next. The License Information screen opens (see [Figure 45](#)).

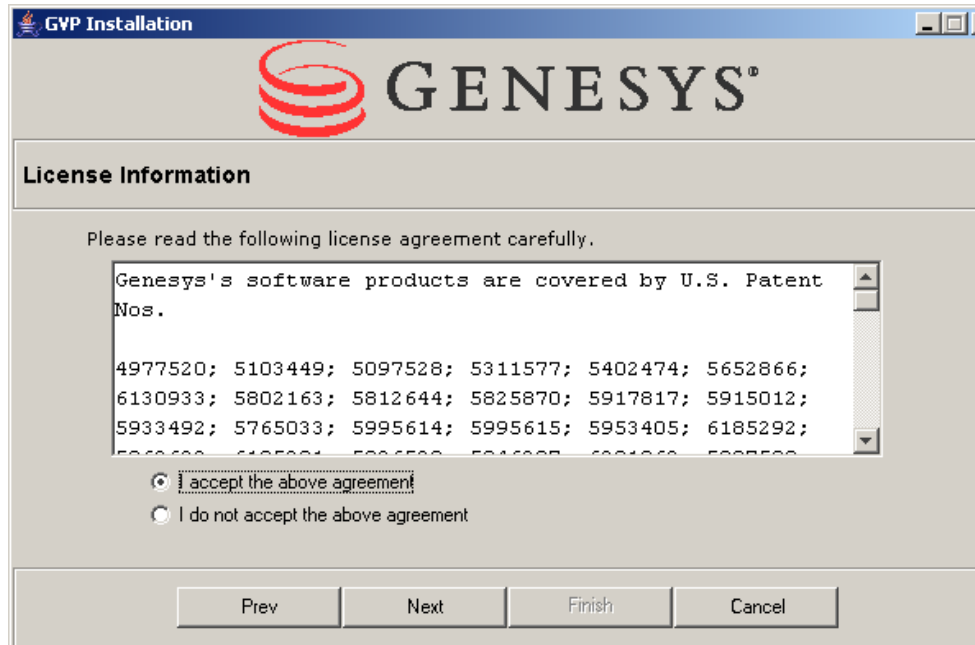

**Figure 45: License Information Screen**

4. Select I accept the above agreement, and then click Next. The Installation Folder screen opens (see [Figure 46](#)).

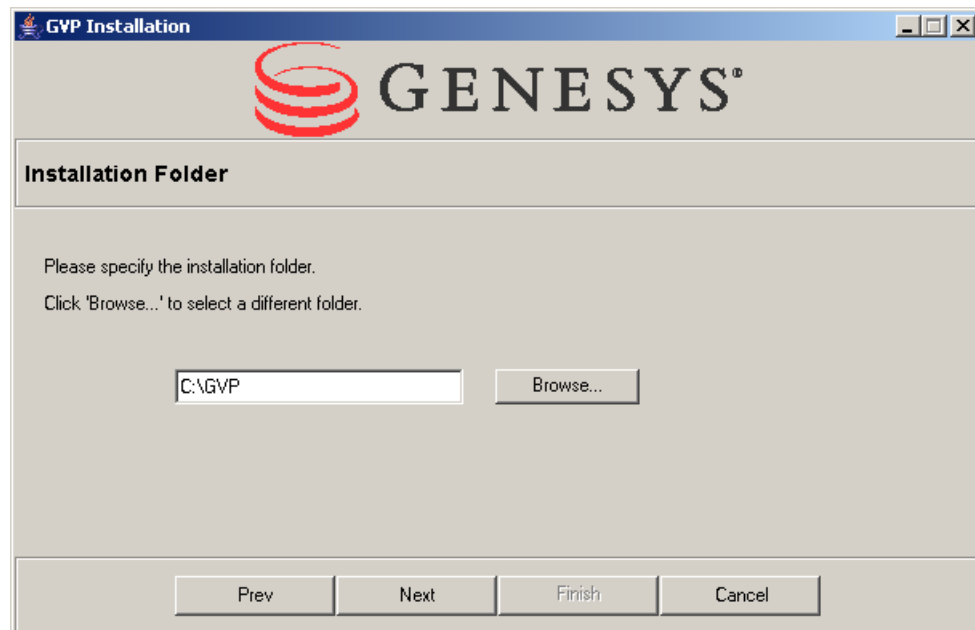

**Figure 46: Installation Folder Screen**

5. Accept the default path or click Browse... to specify the path to install GVP: EE. Click Next. The Component Selection screen for a Single or Multiple box install opens (see [Figure 47](#)).

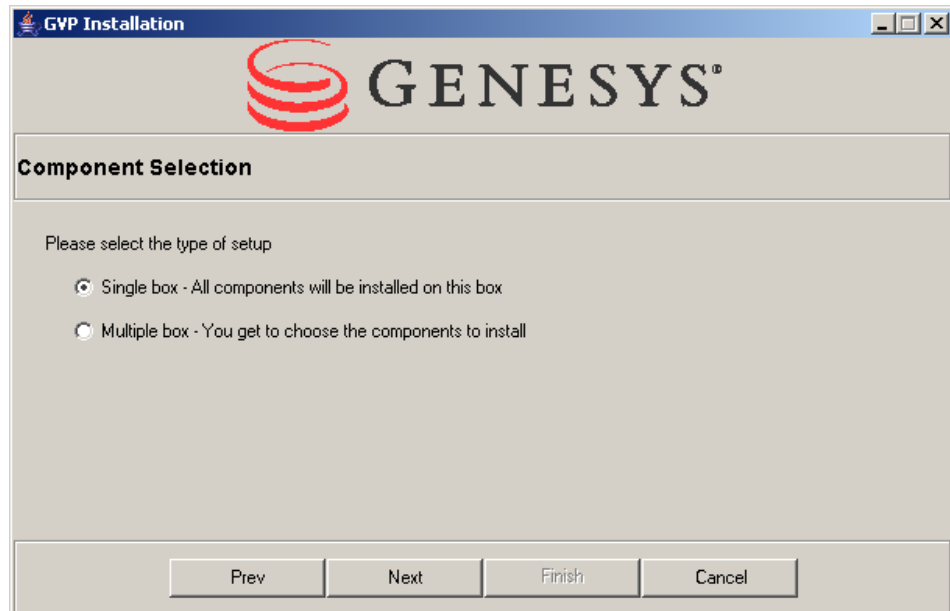

**Figure 47: Component Selection Screen**

6. Select Single box... and then click Next. The Telephony Based Component Selection screen opens (see [Figure 48](#)).

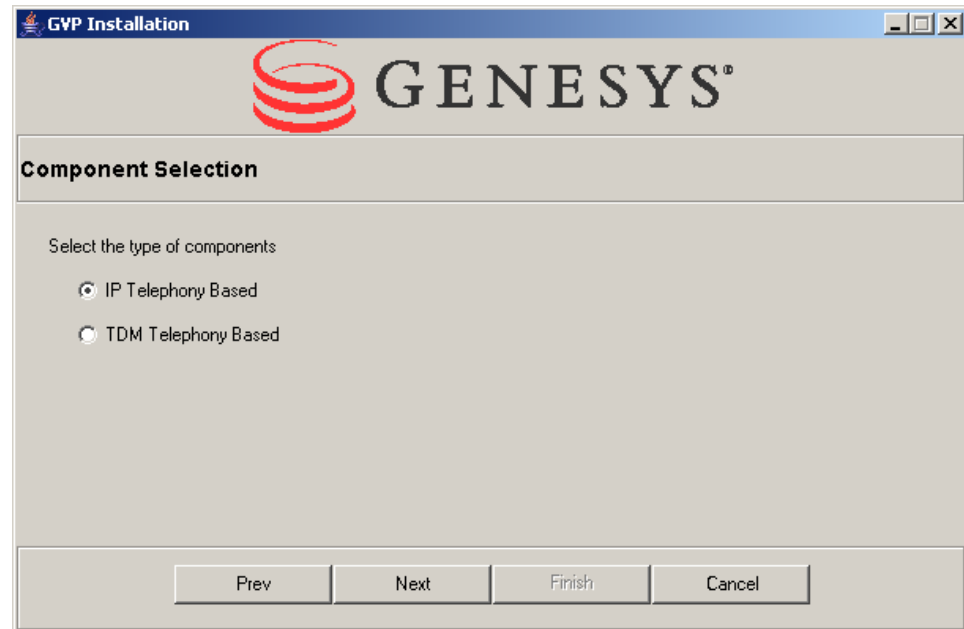

**Figure 48: Component Selection (Telephony Based) Screen**

7. In this example, we are following an IP Telephony-Based upgrade. Select IP Telephony Based and then click Next. The Feature Selection screen opens (see [Figure 49](#)).

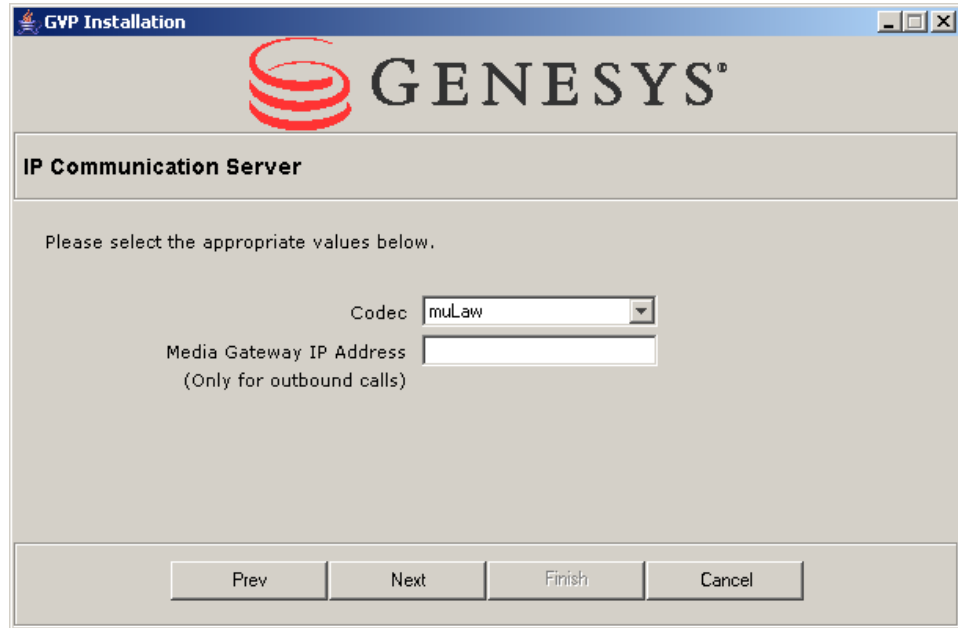

**Figure 49: Feature Selection Screen**

8. Select the features that you want to configure. If you do not want to configure these features as this time, you can clear the check boxes. You can still configure these features at a later time by re-running the `setup.bat` file.

If you do not select a particular feature at this time (for example, IVR Server Client), no prompts occur during the configuration steps for that feature; however, the files for that feature will still be copied during the file-copy and installation steps.

ASR, TTS and IVR Server Client have been selected in this example. Click Next. The IP Communication Server screen opens (see [Figure 50](#)).



**Figure 50: IP Communication Screen**

9. From the Codec drop-down list, select muLaw or aLaw.  
The Codec value is usually muLaw in North America and Japan, and aLaw in other countries. Make sure that the Media Gateway and MRCP servers are using the same Codec value.
10. Enter the Media Gateway IP Address (for outbound calls only).  
You do not need to specify the IP address of the Media Gateway if the IPCS is going to process only inbound calls. For outbound calls, including transfers, you must specify the Media Gateway IP address. Outbound calls will fail if this value is not provided. Click Next.
11. The ASR: MRCP Configuration screen opens (see [Figure 51](#)).

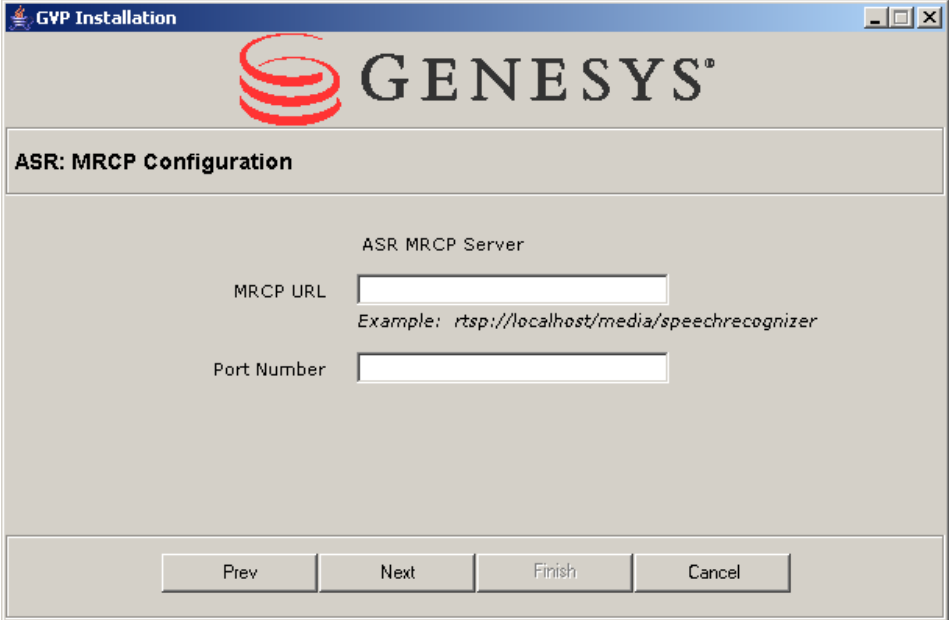

The screenshot shows a window titled "GVP Installation" with the Genesys logo at the top. Below the logo, the title "ASR: MRCP Configuration" is displayed. The main area contains the following fields and text:

- ASR MRCP Server**
- MRCP URL**: A text input field with an example below it: *Example: rtsp://localhost/media/speechrecognizer*
- Port Number**: A text input field

At the bottom of the window, there are four buttons: "Prev", "Next", "Finish", and "Cancel".

**Figure 51: ASR: MRCP Configuration Screen**

12. To enable MRCP ASR, enter the MRCP URL and Port Number for the ASR MRCP server.

For the MRCP URL value, you must replace `localhost` with the fully qualified domain name (FQDN) of the MRCP server. Consult the vendor's MRCP server documentation for additional information.

13. Click Next. The TTS:MRCP Configuration screen opens (see [Figure 52](#)).

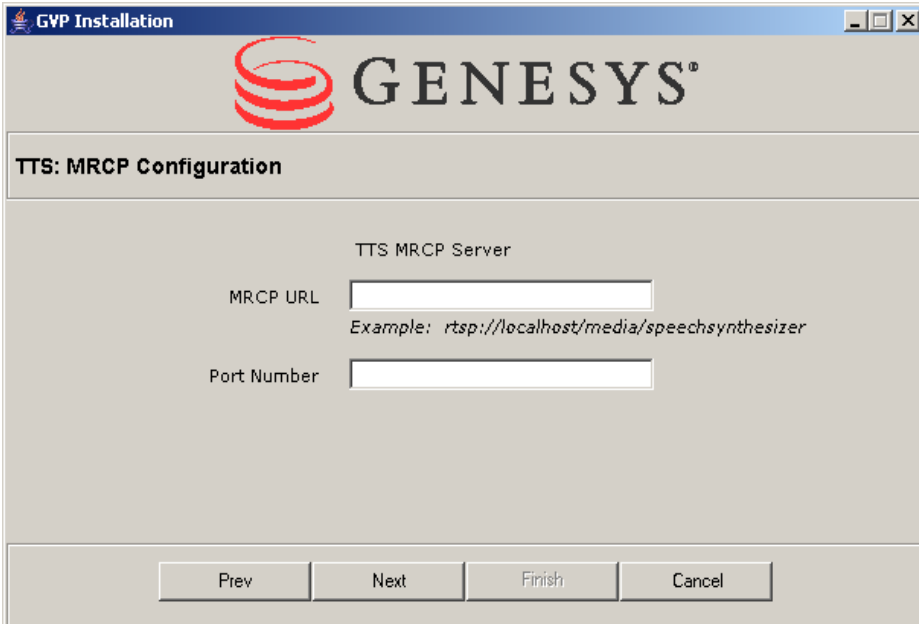

The screenshot shows a window titled "GVP Installation" with the Genesys logo at the top. Below the logo, the title "TTS: MRCP Configuration" is displayed. The main area contains the following fields and text:

- TTS MRCP Server**
- MRCP URL**: A text input field with an example below it: *Example: rtsp://localhost/media/speechsynthesizer*
- Port Number**: A text input field

At the bottom of the window, there are four buttons: "Prev", "Next", "Finish", and "Cancel".

**Figure 52: TTS: MRCP Configuration Screen**

14. To enable MRCP TTS, enter the MRCP URL and Port Number for the TTS MRCP server.

For the MRCP URL value, you must replace localhost with the fully qualified domain name (FQDN) of the MRCP server. Consult the vendor's MRCP server documentation for additional information.

15. Click Next. The IVR Server Client Configuration screen opens (see [Figure 53](#)).

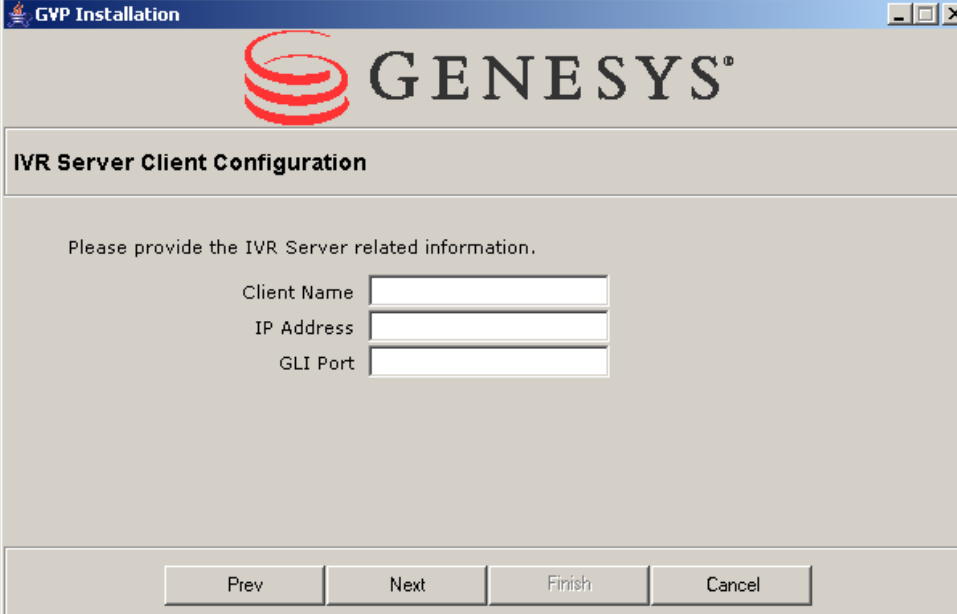

The screenshot shows a window titled "GVP Installation" with the Genesys logo. The main content area is titled "IVR Server Client Configuration" and contains the instruction "Please provide the IVR Server related information." Below this are three input fields labeled "Client Name", "IP Address", and "GLI Port". At the bottom of the window, there are four buttons: "Prev", "Next", "Finish", and "Cancel".

**Figure 53: IVR Server Client Configuration Screen**

16. Enter values for the IVR Server Client Name, IP Address, and GLI port.
  - **Client Name:** Name of the object defined for that IVR in Configuration Manager. The value is case-sensitive. For details, refer to the section about Integration with Genesys Framework in the *Genesys Voice Platform: Enterprise Edition 7.2 Reference Manual*.
  - **IP Address:** IP Address of the machine running the IVR Server.
  - **GLI Port:** Port number of the IVR Server. The value that you enter must be the same as the value specified in the gli-server-address option under the gli\_server\_group\_1 section for the TServer\_IVR Application object defined for this IVR Server in Configuration Manager.

---

**Note:** The GDI Link Interface (GLI) layer is a subset of the Generic Data Interface (GDI) protocol from Telcordia (formerly Bellcore), and is the proprietary transport protocol used to structure TCP/IP messages. This layer is responsible for link-layer functions such as load balancing over multiple network interfaces, and connection-failure detection using keep-alive messages.

---

17. Click Next. The Configuration Summary screen opens (see [Figure 54](#)).

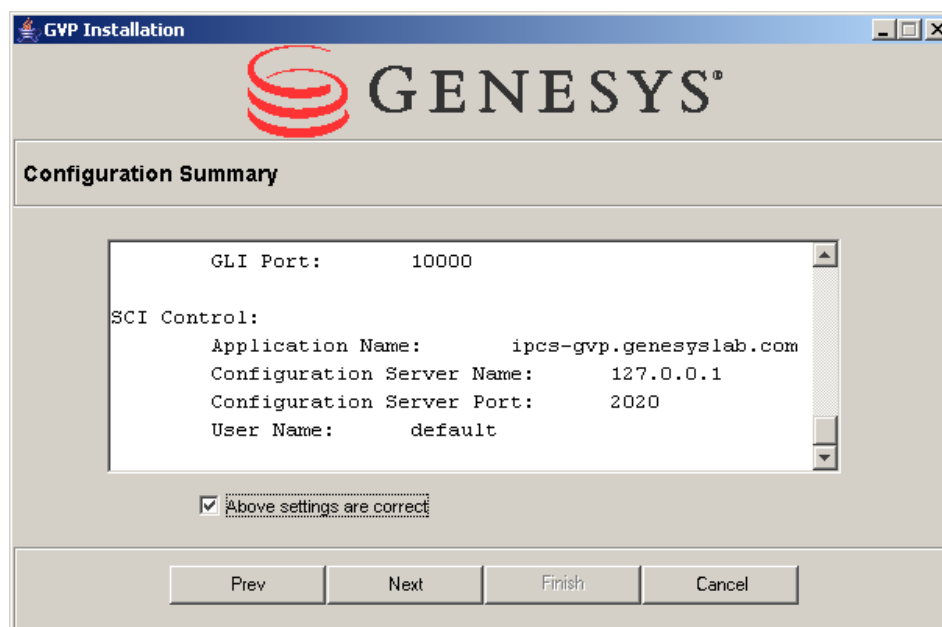

**Figure 54: Configuration Summary Screen**

18. Scroll down and carefully review the information on the Configuration Summary screen, to verify your configuration settings.
- If they are not correct, use the **Prev** button to go back to the previous screens and make the necessary changes.
  - If they are correct, select the **Above settings are correct** check box and then click **Next**.
19. A series of Status screens open displaying the progress of the uninstall. A **Confirm Uninstall** screen opens and prompts **Do you want to completely remove the selected application and all of its features?**. Click **OK** to remove the installed features.
20. The Solution Installer then launches a series of setup programs displaying the progress of the installation. During VPM installation, you are prompted to restore a backup copy of the old database. Choose **Yes** in order to preserve your old configuration.
21. Also, during installation, when prompted for Username and Password, provide this information in the specified format:
- Username - <domainname>\<username>
- Password - <password>
- Click **OK** to proceed. The **Upgrade Result** screen opens (see [Figure 55](#)).



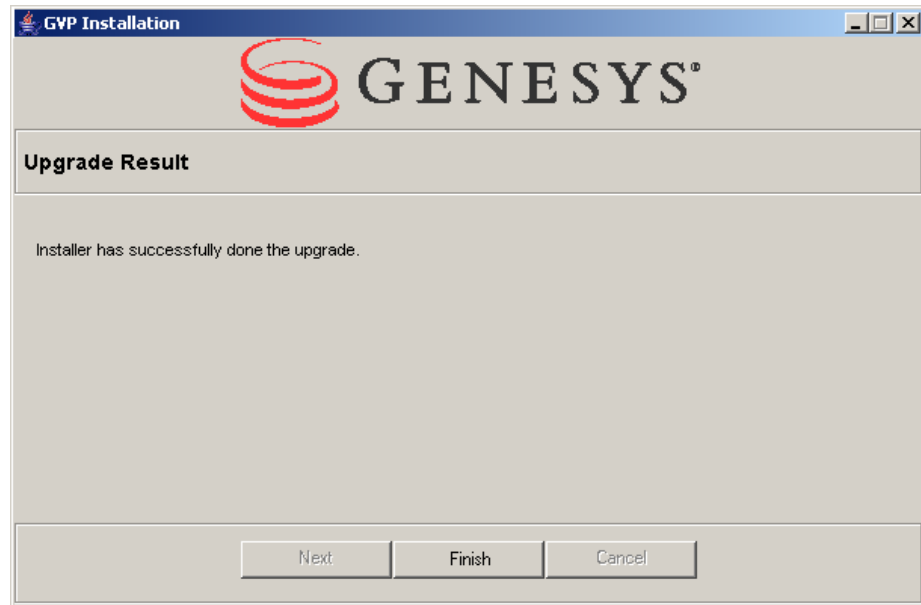

**Figure 55: Upgrade Result Screen**

22. Once the installation is complete, click **Finish**.

23. Restart your GVP: EE machine.

This completes the GVP: EE upgrade.

## Migrating when Previous Deployment was Manually Installed

This section describes how to use the Genesys Voice Platform Solution Installer to upgrade versions (6.5.5, 7.0.2, 7.0.3) of GVP: EE that have been manually installed.

The Solution Installer enables you to either update or uninstall the currently installed version of GVP: EE.

The **Update** option will enable you to make a quick upgrade without making any configuration changes. This option will uninstall all components not supported by GVP: EE 7.2, and then will install/upgrade the previously installed components which are supported by GVP: EE 7.2.

The **Uninstall** option uninstalls all the installed GVP: EE components.

---

### Notes:

- If you plan on upgrading GVP: EE, you must first stop the WatchDog service before launching the solution installer.
  - Genesys does not recommend installation of its components through a Microsoft Remote Desktop connection. The installation should be performed locally.
-

To begin the update:

1. Insert the Genesys Voice Platform: Enterprise Edition DVD on an older pre-existing GVP installed machine.
2. Go to the <GVP CD directory> \solution\_specific \windows \install \ folder and double click the setup.bat file. The GVP: EE Solution Installer Maintenance screen opens (see [Figure 56](#)).

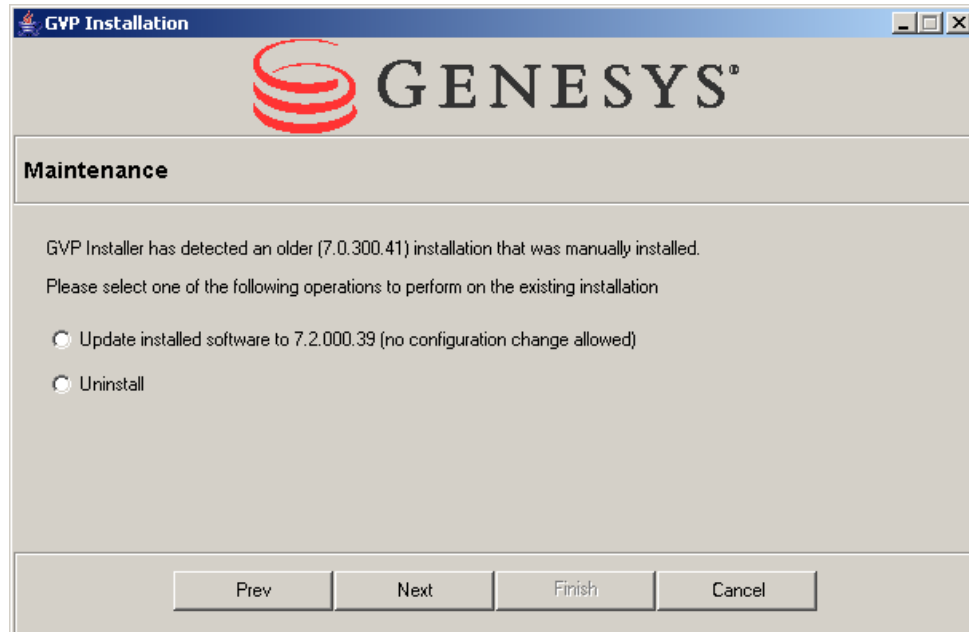

**Figure 56: Maintenance Screen**

3. Select Update installed software to... and then click Next.  
At this point, the Solution Installer will start data collection from the Registry to build a new 7.2 DataStore. A backup of this information will also be created in <installation directory>\installer\backup.
4. Uninstallation of the necessary components will proceed. After the uninstall is complete, the setup will automatically start the installation process launching a series of setup programs displaying the progress of the installation. During VPM installation, you are prompted to restore a backup copy of the old database. Choose Yes in order to preserve your old configuration.
5. Uninstallation of the necessary components will proceed. After the uninstall has completed, the setup will automatically start the installation process. Once the installation is complete, click the Finish button.

---

# Migrating GVP: EE without Solution Installer

This section describes the steps necessary for performing a manual upgrade of GVP: EE.

If you have manually installed GVP: EE 6.5.5 or GVP: EE 7.0.3 or have modified the installation through VPM Server Explorer or modified the Dialogic files, the migration wizard in Solution Installer should not be used for migration to GVP: EE 7.2. In this case, follow the steps below:

1. Follow the steps described in the section “Upgrading Dialogic” on [page 1011](#).
2. Uninstall Voice Portal Manager (VPM) using Add/Remove Programs.
3. Do not uninstall any other GVP components. Manually install the GVP: EE 7.2 components on top of the existing installation by following the steps in Appendix A of the *GVP: EE 7.2 Deployment Guide* (GVP: EE Manual Installation). The following points should be noted:
  - a. When installing VPM, it prompts you about restoring the backup copy of the old database. Choose Yes in order to preserve your old configuration.
  - b. From Appendix A of the *GVP: EE 7.2 Deployment Guide* (GVP: EE Manual Installation), you need to install VPM, GVP Core, Voice Communication Server (VCS), Text-to-Speech (TTS) and IVR Server Client.
  - c. If you are upgrading from GVP: EE 6.5.5, after the GVP: EE 7.2 components are installed, the following steps need to be done:
    - Go to Start > Run and type `regedit` in the box. The Registry editor will open.
    - Navigate to `HKEY_LOCAL_MACHINE > Software > CallNet`. The list of parameters should appear on the right-hand side.
    - Select `ConfigFile`. Right-click and choose `Modify`.
    - Make note of the existing value and then change the value to `gvp.ini`.
    - Save the change and exit out of the registry editor.
    - Using Windows Explorer, navigate to the `config` directory under the GVP install directory. This is typically `C:\cn\config`.
    - Rename the `.ini` file (the one noted 3 steps above) to `gvp.ini`.
4. Because you restored the backup copy of the old (GVP 6.5.5/7.0.3) database, you do not need to configure GVP: EE as described in the following sections of Appendix A of the *GVP: Enterprise Edition 7.2 Deployment Guide*:
  - a. Configuring GVP: EE for Behind-the-Switch.

**b.** Configuring GVP: EE for In-front-of-the-Switch.

---

**Note:** To verify your configuration, follow the steps in Appendix A of the *GVP: EE 7.2 Deployment Guide*.

---



## Chapter

# 58

## Migration for Genesys Voice Platform: Developer's Edition

This chapter provides information on how to migrate the Genesys Voice Platform: Developer's Edition (GVP: DE) from GVP: DE 6.5.4 or 7.0.3 to GVP: DE 7.2. The sections in this chapter are presented in the order you must upgrade the GVP: DE components:

- [Migration Strategy, page 1025](#)
- [Migrating Third-Party Software, page 1026](#)
- [Migrating Genesys Voice Platform: Developer's Edition, page 1027](#)

---

### Migration Strategy

The Migration Wizard does not support migration of configuration information from previous versions of GVP: DE software to the current version. If you have a previously working version of GVP: DE, make note of the configuration information, and then uninstall the GVP software. Reboot the system and install the GVP: DE 7.2 software according to the instructions in the *Genesys Voice Platform: Developer's Edition 7.2 Deployment Guide*.

---

**Note:** If you were using non-Media Resource Control Protocol (MRCP) speech engines, you will have to configure new Automatic Speech Recognition (ASR) and Text-to-Speech (TTS) features that use MRCP.

---

---

# Migrating Third-Party Software

The third-party software described in the following sections should be upgraded. For further information on these products, consult your vendor.

## Migrating from OSR to MRCP ASR

### Uninstalling OSR 1.1.4/2.0

1. Go to Control Panel > Administrative Tools > Services, stop the WatchDog service, and then set the service Startup type to Manual.
2. Uninstall SpeechWorks OSR 1.1.4/2.0 using Add/Remove Programs.
3. Back up the existing license file.
4. Restart the computer.
5. Delete the existing SpeechWorks directory.
6. Restart the computer.

### Upgrading to MRCP ASR

To upgrade to MRCP ASR, install the MRCP server software using the vendor's instructions. Confidence scores from applications may need to be recalibrated. Consult the MRCP vendor for details.

---

**Note:** If you are upgrading from OSR to MRCP ASR, change the applications' ASR Type in Voice Portal Manager (VPM).

---

## Migrating from Speechify to MRCP TTS

### Uninstalling Speechify 2.1.6/3.0.2

1. Go to Control Panel > Administrative Tools > Services, stop the WatchDog service, and then set the service Startup type to Manual.
2. Uninstall Speechify 2.1.6/3.0.2 voice fonts using Add/Remove Programs.
3. Uninstall Speechify 2.1.6/3.0.2 software using Add/Remove Programs.
4. Restart the computer.

### Upgrading to MRCP TTS

To upgrade to MRCP TTS, install the MRCP server software using the vendor's instructions. Consult the MRCP vendor for details.

---

**Note:** If you are upgrading from Speechify to MRCP TTS, change the TTS Vendor on the Voice Application page in VPM.

---

## Migrating from RealSpeak to MRCP TTS

1. Go to Control Panel > Administrative Tools > Services, stop the WatchDog service, and then set the service Startup type to Manual.
2. Uninstall RealSpeak 3.5 using Add/Remove Programs.
3. Restart the computer.

## Upgrading to MRCP TTS

To upgrade to MRCP TTS, install the MRCP server software using the vendor's instructions. Consult the MRCP vendor for details.

---

# Migrating Genesys Voice Platform: Developer's Edition

This section describes the steps necessary for performing an upgrade of GVP: DE 6.5.4 or GVP: DE 7.0.3 to GVP: DE 7.2.

1. Uninstall your previous version of GVP: DE using Solution Installer or Add/Remove Programs.
2. Restart the machine.
3. Upgrade third-party ASR and TTS Speech Engines, if necessary, to MRCP compliant speech engines.
4. Install GVP: DE 7.2 using the Solution Installer. When installing VPM, it prompts you about restoring the backup copy of the old database. Choose Yes in order to preserve your old configuration.
5. Configure GVP: DE 7.2 as described in the *Genesys Voice Platform: Developer's Edition 7.2 Deployment Guide*.







## Chapter

# 59

## Migration for Genesys Voice Platform: Studio

This chapter provides information on how to migrate Genesys Voice Platform (GVP): Studio. It contains the following sections:

- [Migration Considerations, page 1029](#)
- [Upgrading to Studio 7.6, page 1034](#)
- [Upgrading to Studio 7.5, page 1036](#)
- [Upgrading to Studio 7.2, page 1038](#)
- [Upgrading to Studio 7.0.3, page 1040](#)

---

### Migration Considerations

Before migrating your applications, you must take time to consider all of the requirements needed in your environment.

### Windows 2003 Specifics

The following special settings are required for running applications on Windows 2003, IIS 6.0 Web Server.

#### Post data size limit

By default, in IIS 6.0, a default limit has been imposed on the amount of data that can be sent in HTTP POST. This setting must be changed if you use Recording or VAR.

Follow the steps below for changing the default limit of the POST data from 200K to 500MB. A limit of 500MB enables you to have recordings of up to 30 minutes long:

1. Open the `MetaBase.XML` file, which is located in `c:\Windows\System32\Inetsrv`. Find the line `AspMaxRequestEntityAllowed` and change the value to `524288000`.
2. This change does not require stopping IIS, but to make the `Metabase.xml` file writable, go to the IIS control panel, right click the server, select `Properties`, and select the check box `allow changes to MetaBase configuration while IIS is running`.

---

**Note:** These steps are also required on the IIS 6.0 server where the final Studio generated ASP application will be deployed. If the VAR Server is also deployed on Windows 2003, you must also change this configuration on the VAR Server side.

---

## MIME Type Mappings

On Windows 2003, Multipurpose Internet Mail Extension (MIME) type needs to be added for serving audio and grammar files. The following mime types must be added:

1. `.vox = application/octet-stream`
2. `.wav = application/octet-stream`
3. `.grxml = application/srgs+xml`

## VoiceXML 2.1 W3C R Support

Studio 7.2 and later generates VoiceXML that conform to the VoiceXML 2.1 W3C R specification (with Genesys Extensions to VoiceXML 2.1). Note the following:

1. The `Form Editor Schema validator` in the `Form block` now supports the full VoiceXML 2.1 specification (along with Genesys extensions). When you select `Normalize` and `Validate`, the validation errors are now reported in a validation window.
2. If the application uses inline grammars or embedded `Speech Synthesis Markup Language (SSML)` tags in the `FORM Editor block`, you might have to change them in order to make them conform to the VoiceXML 2.1 specification. Refer to [“ASR Engine Support”](#) and [“TTS Engine Support”](#) on [page 1032](#) for more details.

## VoiceXML 2.0 W3C R Support

Studio 7.0.3 generates VoiceXML that conforms to the VoiceXML 2.0 W3C R specification (with Genesys Extensions to VoiceXML 2.0). Note the following:

1. The Form Editor Schema validator in the Form block now supports the full VoiceXML 2.0 specification (along with Genesys extensions). When you select Normalize and Validate, the validation errors are now reported in a validation window.
2. If the application uses inline grammars or embedded Speech Synthesis Markup Language (SSML) tags in the FORM Editor block, you might have to change them to conform to the VoiceXML 2.0 specification. Refer to “ASR Engine Support” and “TTS Engine Support” on [page 1032](#) for more details.

## ASR Engine Support

For Studio 7.0.3 and later, all grammars generated by Studio in its blocks conform to the Speech Recognition Grammar Specification (SRGS) 1.0 specification. The following features have changed as a result:

- Studio now generates ASR engine neutral grammars for the Input, DB\_INPUT, MENU and Treatment blocks. As a result, the ASR\_ENGINE application setting variable (defined in the START block) is no longer used.
- If you use inline grammars in the FORM block, they must conform to the SRGS 1.0 specification.

If for some reason, the grammar that you specify does not conform to the SRGS 1.0 specification and you are sure that the syntax will work on the ASR engine that you are using in your application, you can override the validation in the FORM block. From the Tools Menu->Options dialog box, select the Ignore Schema Validations check box. When this option is selected, Studio enables you to generate code for the Form block even if it contains validation errors. Make sure that you exercise great caution while using this option, as it could result in runtime errors if the syntax is incorrect.

- In the FORM block, the mixed initiative wizard now generates grammars conforming to the SRGS 1.0 specification.

## Migrating Studio Applications from OSR 1.1.4 to OSR 2.0 or Later

---

**Note:** The following information is applicable only to Studio release 7.0.3.

---

If you are migrating your Studio developed applications from OSR 1.1.4 to OSR 2.0 or later, consider the following:

### Confidence Scores

If you are migrating an application from Scansoft’s OSR 1.1.4 to OSR 2.0 or later, and the application uses confidence scores, be aware that OSR 2.0 and later uses newly calibrated confidence scores for recognition results. This

might impact your application. Refer to the *Scansoft Speechworks OpenSpeech Recognizer 2.0 Migration Guide* for more details.

## Migrating Studio Applications to MRCP ASR

If you are migrating your Studio developed applications to MRCP, consider the following:

### Confidence Scores

If you are migrating an application to MRCP ASR and the application uses confidence scores, the confidence scores may have to be recalibrated. Consult the MRCP vendor for details.

## TTS Engine Support

In Studio 7.0.3 and later, the FORM block supports SSML 1.0 in the schema validation. If the application uses embedded SSML tags in the FORM block, they must conform to the SSML 1.0 specification.

---

**Note:** If for some reason, the embedded SSML tags that you specify do not conform to the SSML 1.0 specification and you are certain that the syntax will work on the TTS engine that you are using in your application, you can override the validation in the FORM block. From the Tools Menu->Options dialog box, select the Ignore Schema Validations check box. When this option is selected, Studio enables you to generate code for the FORM block even if it contains validation errors. Make sure that you exercise great caution while using this option as it could result in runtime errors if the syntax is incorrect.

---

## OSDM Support

Studio 7.0.3 and later supports Scansoft's OSDM 2.0.

In order to have OSDM 2.0.2 work with SWMS 3.1.x and OSR 3.0, the following configuration is required:

Set the following properties in the web.xml of the osdm2-core package:

- browser = genesys
- recognizer = osr3.0

In order to have OSDM 2.0 to work with OSR 2.0, the following configuration is required:

Set the following properties in the web.xml of the osdm2-core package:

- browser = genesys
- recognizer = osr2.0

You must be aware of the following when migrating applications from OSDM 1.0.x to OSDM 2.0:

1. In OSDM 2.0, the parameter passing mechanism changed and all input parameters are now passed using `nameList`. A new attribute has been added in the Studio `Subcallflow` block to allow passing parameters using `nameList`.
2. The URL for the OSDM 2.0 module is different from that of the OSDM 1.0 module. You must change the URL for invoking the OSDM in your applications. Refer to the Studio template applications and OSDM subcallflows for reference.
3. The input parameters when passed using `nameList` cannot contain “.” in the name of the input parameter.
4. The `ItemList` OSDM is no longer present in OSDM 2.0.
5. The Core and Commerce OSDM are now part of a single package.
6. Pass the following parameters while invoking an OSDM from the application—see the template applications in Studio for examples:
  - `dmname`—this is required for Scansoft logging and has become a mandatory parameter in OSDM 2.0.
  - `property_termchar`—exclude so that the OSDM does not set the VoiceXML `termchar` property. The default value generated is `none`, which is invalid in MRCP.
7. If you need to pass VoiceXML properties or custom values to the OSDM as part of the input parameters, they must now be prefixed with `property_` and `custom_` respectively.
8. Refer to the *Scansoft SpeechWorks OpenSpeech DialogModules 2.0 Migration Guide* for more details.

## Exception Handling

In Studio 7.0.3 and later, names of some of the Studio generated exceptions have changed. The upgrade takes care of changing the names for existing applications and no manual changes are required. Refer to [Table 170](#).

**Table 170: Exceptions**

Old Name	New Name
DBERROR	error.com.genesys.studio.dberror
EMPTY_RECORDSET_ERROR	error.com.genesys.studio.emptyrecordset
ACCESS_NUMGET_ERROR	error.com.genesys.studio.accessnumgeterror
STATISTICS_ERROR	error.com.genesys.studio.statisticerror

**Table 170: Exceptions**

Old Name	New Name
Nomatch_Final	error.com.genesys.studio.toomanynomatches
Noinput_Final	error.com.genesys.studio.toomanynoinputs

Note the following changes in behavior:

1. In case of a Studio generated error, detailed error information is now returned.
2. It is now possible to handle all application exceptions in the Start block. All local exceptions, if not handled at the block level, are now caught by the Start block. This is also applicable for the Studio generated exceptions. The same is also applicable for Subcallflow. If the exceptions are not handled by the Subcallflow\_Start block, they get raised to the calling callflow.
3. A new All catch handler has been introduced in the Start block. This provides full control in the application for handling unexpected exceptions and events. Earlier, these used to get raised to the SystemRoot of the platform.
4. If the caller hangs up inside a subcallflow and the hangup event is connected to a Return block, the call terminates inside the subcallflow and no further pages are executed in the application.

## Recording Support

In Studio 7.0.3 and later, it is now possible to use dynamic names for saving the recorded files. In order to do so, the Capture tab settings now appear in the Record block instead of the Capture block. This change automatically occurs during the upgrade, and no changes are required in the application.

In Studio 7.6, support for new audio formats has been added. Refer to Studio 7.6 Help file for the supported audio formats list.

---

## Upgrading to Studio 7.6

Studio 7.6 applications work with the 7.6, 7.5, and 7.2 releases of the Genesys Voice Platform (GVP). For differences in behavior for a specific release of GVP, see the *Genesys Voice Platform 7.6 Studio Deployment Guide* and the *Studio 7.6 Help* file.

If you are migrating applications that were developed using Studio 6.5.5, 7.0.3, 7.2, or 7.5 to the 7.6 release, you need to be aware of the following:

1. You must migrate the platform to GVP 7.6.

2. Studio 7.6 applications perform on all editions of GVP 7.6, GVP 7.5, and GVP 7.2.

If your application is targeted for GVP 7.2, open **Tools > Options**, and then select **GVP 7.2** from the **VXML Browser** drop-down list. Additional validation will be done at code generation time, and the generated code will be compliant with GVP 7.2.

If your application is targeted for GVP 7.5, open **Tools > Options**, and select **GVP 7.5+** from the **VXML Browser** drop-down list. Additional validation will be done at code generation time, and the generated code will be compliant with GVP 7.5.

3. If the **VXML Browser** option is set to **GVP 7.5+**, **VAR Events for Transfer blocks** are generated as **Start and Stop IVR Action events**. This enables reporting of failure conditions. If you need to generate **VAR Events** as in previous versions, you must define the variable `reportitem_transferreportingflag` in the application **START** block, and set its value to `0`.
4. If you are migrating from **Voice Portal Manager (VPM)** to **7.6 GVP Element Management Provisioning System (EMPS)**, make sure that you use the **7.6 GVP EMPS Data Migration tool** which is part of **GVP 7.6 EMPS IP**.

## Upgrading to 7.6

When a Studio 6.5.5, 7.0.3 or 7.2 callflow is opened in Studio 7.6, it is upgraded to the new 7.6 release.

---

**Notes:** There is no automatic upgrade available for the underlying platform or any external grammars. You must upgrade GVP to the 7.6 release before upgrading the applications to Studio 7.6.

If the application uses **Voice Application Reporting (VAR)**, note the name of the **VAR Server** prior to uninstalling Studio. The **VAR Server** name setting is not carried over by the upgrade.

---

### To upgrade Studio 6.5.5, 7.0.3, 7.2, or 7.5 to Studio 7.6:

1. Uninstall the Genesys Voice Platform Studio components. Refer to the appropriate release of the *Genesys Voice Platform Genesys Studio Deployment Guide* for those instructions.
2. Delete the `VXMLStudioSimulation` and `VXMLStudio` virtual directories from the Internet Information Server (IIS).
3. Uninstall the **VAR COM Client**. For more information, refer to the appropriate release of the **GVP Studio and VAR** documentation.
4. Install the **Genesys Voice Platform: Studio 7.6** software according to the instructions in the *Genesys Voice Platform 7.6 Studio Deployment Guide*.

5. Install the required VAR Clients according to the *Genesys Voice Platform 7.6 Voice Application Reporter Deployment and Reference Manual*.
6. Migrate applications created with prior releases of Studio. Open all of the Studio applications, and select Yes when prompted to convert these applications to GVP 7.6. In the case of subcallflows, Studio displays a list of associated .vws files and prompts you to upgrade these files.
7. Click Yes to confirm the upgrade.
8. When you upgrade, Studio takes a backup of all of the associated .vws files, upgrades them, and then saves them. It then displays an upgrade report showing the full details of all upgraded callflows and the backup location for these callflows.

---

**Note:** If you are using VAR for both ASP and JSP applications, the respective VAR Client must be installed on the Web Application Server separate from VAR 7.6.

---

---

## Upgrading to Studio 7.5

Studio 7.5 applications work with the 7.5 and 7.2 releases of the Genesys Voice Platform (GVP). For differences in behavior for a specific release of GVP, see the *Genesys Voice Platform 7.5 Studio Deployment Guide* and the *Studio 7.5 Help* file.

If you are migrating applications that were developed using Studio 6.5.5, 7.0.3, or 7.2 to the 7.5 release, you need to be aware of the following:

1. You must migrate the platform to GVP 7.2 or 7.5.
2. Voice Application Reporter (VAR) Server and Clients are now bundled separately on the VAR DVD. The VAR Clients for Active Server Pages (ASP) and Java Server Pages (JSP) are included with VAR. The VAR Server name is now always configured in the VAR Client and not in the application as in previous versions of Studio. For JSP applications, you must explicitly configure the VAR Client port number. For upgraded applications, the VAR Client port is set to the default value of 9815.
3. For JSP applications using the Studio DB blocks, the Java Database Connectivity (JDBC) drivers are now included with the Studio generated code, and do not need to be installed separately. Depending on the type of driver required, the database client software may need to be installed on the development or production servers. For more information, see the “Database Drivers” topic in the *Studio Help* file.
4. Studio no longer supports IBM Websphere 5.0. You must upgrade to IBM Websphere 6.0.
5. Studio generated Java Server Page (JSP) applications now require Java Development Kit (JDK) release 1.4.2 or higher.



6. Studio 7.5 applications perform on all editions of GVP 7.5 and GVP 7.2. If your application is targeted for GVP 7.2, open **Tools > Options**, and select GVP 7.2 from the **VXML Browser** drop-down list. Additional validation will be done at code generation time, and the generated code will be compliant with GVP 7.2.
7. If the **VXML Browser** option is set to GVP 7.5, VAR Events for Transfer blocks are generated as Start and Stop IVR Action events. This enables reporting of failure conditions. If you need to generate VAR Events as in previous versions, you must define the variable `reportitem_transferreportingflag` in the application START block, and set its value to 0.
8. If you are migrating from Voice Portal Manager (VPM) to 7.5 GVP Element Management Provisioning System (EMPS), make sure that when you provision an application, the `Default QueryString` is added for both Primary and Backup IVR URLs. EMPS does not add the `Default QueryString` to the application IVR URL automatically. If it is not added, the VAR reports will display zero for the call duration and empty values for ANI and DNIS.

## Upgrading to 7.5

When a Studio 6.5.5, 7.0.3, or 7.2 callflow is opened in Studio 7.5, it is upgraded to the new 7.5 release.

---

**Notes:** There is no automatic upgrade available for the underlying platform or any external grammars. You must upgrade GVP to the 7.5 release before upgrading the applications to Studio 7.5.

If the application uses Voice Application Reporting (VAR), note the name of the VAR Server prior to uninstalling Studio. The VAR Server name setting is not carried over by the upgrade.

---

### To upgrade Studio 6.5.5, 7.0.3, or 7.2 to Studio 7.5:

1. Uninstall the Genesys Voice Platform Studio components. For detailed instructions about each component, refer to the following guides:
  - *Genesys Voice Platform 7.2 Genesys Studio Deployment Guide*
  - *Genesys Voice Platform 7 Genesys Studio Deployment Guide*
  - *Genesys Voice Portal 6.5 Genesys Studio Developer's Guide*
2. Delete the `VXMLStudioSimulation` and `VXMLStudio` virtual directories from the Internet Information Server (IIS).
3. Uninstall the VAR COM Client. For more information, see the following guides:
  - *Genesys Voice Platform 7.2 Genesys Studio Deployment Guide*
  - *Genesys Voice Platform 7 Genesys Studio Deployment Guide*

- *Genesys Voice Portal 6.5 Genesys Studio Developer's Guide*
- 4. Install the Genesys Voice Platform: Studio 7.5 software according to the instructions in the *Genesys Voice Platform 7.5 Studio Deployment Guide*.
- 5. Install the required VAR Clients according to the *Genesys Voice Platform 7.5 Voice Application Reporter Deployment and Reference Manual*.
- 6. Migrate applications created with prior releases of Studio. Open all of the Studio applications, and select Yes when prompted to convert these applications to GVP 7.5. In the case of subcallflows, Studio displays a list of associated .vws files, and prompts you to upgrade these files.
- 7. Click Yes to confirm the upgrade.

When you upgrade, Studio takes a backup of all of the associated .vws files, upgrades them, and then saves them. Studio then displays an upgrade report showing the full details of all upgraded callflows and the backup location for these callflows.

---

**Note:** If you are using VAR for both ASP and JSP applications, the respective VAR Client must be installed on the Web Application Server separate from VAR 7.5.

---

---

## Upgrading to Studio 7.2

Studio 7.2 applications work only with the 7.2 release of the Genesys Voice Platform (GVP). For differences in behavior for a specific release of GVP, see the *Genesys Voice Platform 7.2 Genesys Studio Deployment Guide*, and the *Studio 7.2 Help* file.

If you are migrating applications that were developed using Studio 6.5.5 or 7.0.3 to the 7.2 release, you need to be aware of the following:

1. You must migrate the platform to GVP 7.2.
2. GVP 7.2 and later interface with ASR engines only with the Media Resource Control Protocol (MRCP) interface. You must upgrade to one of the MRCP ASR engines that GVP 7.2 supports.
3. GVP 7.2 and later interface with the TTS engines with the MRCP interface. You must upgrade to one of the MRCP TTS engines that GVP 7.2 supports.
4. GVP 7.2 and later no longer support OSR 2.0, Realspeak 3.5, and Speechify 3.0.

---

**Note:** Studio 7.2 and later support MRCP ASR and TTS only. It does not support OSR 2.0.

---

5. Studio 7.2 and later use the VoiceXML session variables to access the `ScriptId` that is passed from the URS Strategy. If no value is received, the `ScriptId` value is set to `undefined`. If you are using `$sid$` as a condition in the Branching block, change the condition's value to `undefined` to match the default case.
6. Studio 7.2 and later Active Server Page (ASP) and JSP applications generate explicit cache-control headers that expire immediately. Studio does not generate cache-control headers for audio files, external grammars, and javascript files. These files must be configured on the web application server configuration.
7. Studio 7.2 and later no longer shows the predefined global variables (for example, `ScriptId` and `LAST_EVENT_NAME`) on the Application Settings tab of the `START` and `SubCallFlow_Start` blocks. However, these variables are still available for selection in the drop-down list when selecting dynamic variables.

## Upgrading Studio to 7.2

When a Studio 6.5.5 or 7.0.3 callflow is opened in Studio 7.2, it is upgraded to the new 7.2 release.

---

**Notes:** There is no automatic upgrade available for the underlying platform or any external grammars. You must upgrade GVP to the 7.2 release before upgrading the applications to Studio 7.2.

If the application uses Voice Application Reporter (VAR), note the name of the VAR Server prior to uninstalling Studio. The VAR Server name setting is not carried over by the upgrade.

---

### To upgrade Studio 6.5.5 or 7.0.3 to Studio 7.2:

1. Uninstall the Genesys Voice Platform Studio components. For detailed instructions on each component, refer to the following guide:
  - *Genesys Voice Platform 7 Genesys Studio Deployment Guide*
  - *Genesys Voice Portal 6.5 Genesys Studio Developer's Guide*
2. Delete the `VXMLStudioSimulation` and `VXMLStudio` virtual directories from the Internet Information Server (IIS).
3. Uninstall the VAR COM Client.
4. Install the Genesys Voice Platform: Studio 7.2 software according to the instructions in the *Genesys Voice Platform 7.2 Genesys Studio Deployment Guide*.
5. If you are using VAR for ASP applications, install the VAR COM Client from the Studio/VARCom folder.

6. Migrate applications created with prior releases of Studio. Open all of the Studio applications, and select **Yes** when prompted to convert these applications to GVP 7.2. In the case of subcallflows, Studio displays a list of associated .vws files, and prompts you to upgrade these files.

7. Click **Yes** to confirm the upgrade.

When you upgrade, Studio takes a backup of all of the associated .vws files, upgrades them, and then saves them. It then displays an upgrade report showing the full details of all upgraded callflows, and the backup location for these callflows.

---

## Upgrading to Studio 7.0.3

Studio 7.0.3 applications work only with GVP 7.0.3. For differences in behavior for a specific release of GVP, see the *Genesys Voice Platform 7 Genesys Studio Deployment Guide*, and the *Studio 7 Help* file. If you are migrating applications developed using Studio 6.5.5 to the Studio 7.0.3 release, you need to be aware of the following:

1. You must migrate the platform to GVP 7.0.3.
2. GVP 7.0.3 no longer supports Scansoft's OSR (Open Speech Recognizer) 1.1.4 Automatic Speech Recognition (ASR) engine. If the application is using OSR 1.1.4, you must upgrade the ASR engine to either Scansoft's OSR 2.0 or to one of the Media Resource Control Protocol (MRCP) ASR engines that GVP 7.0.3 supports. Also note that the OSR 2.0 ASR engine is only supported by GVP: EE 7.0.3 (VCS only).
3. GVP 7.0.3 no longer supports the Nuance 8.0 ASR engine. If the application is using Nuance 8.0, you must migrate to one of the MRCP ASR engines that GVP 7.0.3 supports.
4. Studio 7.0.3 and later versions support Scansoft's OpenSpeech DialogModule (OSDM) 2.0. If the application is using OSDM 1.x, you must upgrade the OSDM to OSDM 2.0.
5. GVP 7.0.3 and later no longer supports the Speechify 2.1.6 Text-to-Speech (TTS) engine. If you are using Speechify 2.1.6, you must upgrade to Speechify 3.0 or to one of the MRCP TTS engines that GVP 7.0.3 supports by GVP 7.0.3.
6. Studio 7.0.3 and later no longer supports MySQL database in the DB blocks.
7. Studio 7.0.3 and later no longer supports Oracle 8i in the DB blocks. If the application uses Oracle 8i, you must upgrade to Oracle 9i.
8. Studio 7.0.3 and later no longer supports Access 2000 in the DB blocks. If the application uses Access 2000, you must upgrade to Access 2003.

9. Studio 7.0.3 and later have the ability to propagate events from the subcallflows to the main callflow in order to handle exceptions at the main callflow. Genesys recommends that exceptions be handled in the main callflow instead of the subcallflow.
10. The `Configure to Go Live` option has been removed from Studio 7.0.3. If you are migrating from Studio for GVP: EE and GVP: DE to Studio 7.0.3 or later, you must now deploy the application to a web application server, and then provision it in VPM for making calls.

## Upgrading to 7.0.3

When a Studio 6.5.5 callflow is opened in Studio 7.0.3, it is upgraded to the new 7.0.3 release.

---

**Notes:** There is no automatic upgrade available for the underlying platform or any external grammars. You must upgrade GVP to the 7.0.3 release before upgrading the applications to Studio 7.0.3.

If the application uses Voice Application Reporter (VAR), note the name of the VAR Server prior to uninstalling Studio. The upgrade process does not carry over the VAR Server name setting.

---

### To upgrade Studio 6.5.5 to 7.0.3:

1. Uninstall the Genesys Voice Platform Studio 6.5.5 components. Refer to the *Genesys Voice Portal 6.5.Genesys Studio Developer's Guide* for detailed instructions on each component.
2. After uninstalling the previous release of Studio, make sure that the `VXMLStudioSimulation` virtual directories have been removed from Internet Information Server (IIS).
3. Uninstall the VAR COM Client.
4. Install the Genesys Voice Platform Studio 7.0.3 software according to the instructions in the *Genesys Voice Platform 7 Genesys Studio Deployment Guide*.
5. If you are using the Voice Application Reporter, install the VAR COM Client for ASP applications.
6. To migrate applications created with Studio 6.5.5, open all of the Studio applications, and select `Yes` when prompted to convert these applications to GVP: EE 7.0.3. In the case of subcallflows, Studio displays a list of associated `.vws` files and prompts you to upgrade these files.
7. Click `Yes` to confirm the upgrade. When you upgrade, Studio takes a backup of all of the associated `.vws` files, upgrades them, and then saves them. Studio then displays an upgrade report showing the full details of all upgraded callflows and the backup location for these callflows.





## Chapter

# 60

## Migration for Genesys Voice Platform: VAR

This chapter provides information on how to upgrade Genesys Voice Platform (GVP): Voice Application Reporter (VAR). It contains the following sections:

- [Upgrading VAR to 7.6, page 1043](#)
- [Upgrading VAR to 7.5, page 1045](#)
- [Upgrading VAR to 7.2, page 1048](#)
- [Upgrading VAR to 7.0.3, page 1049](#)

---

## Upgrading VAR to 7.6

### Windows

To upgrade Voice Application Reporter (VAR) Server 6.5.5, 7.0.3, 7.2, or 7.5 to VAR Server 7.6:

1. Stop posting events to the VAR Server.
2. Run the VAR Server for two cycles in order to process all the posted events. If events still exist, back up these files.
3. Stop the AppReporter scheduled task.
4. Backup the VAR Database.
5. Backup the VAR log files.
6. Uninstall the existing Genesys Voice Platform VAR components. For more detailed instructions, see the *Genesys Voice Platform 7.2 Genesys Studio Deployment Guide*, the *Genesys Voice Platform 7 Genesys Studio Deployment Guide*, or the *Genesys Voice Portal 6.5 Genesys Studio Developer's Guide*.

7. Install the Genesys Voice Platform Voice Application Reporter 7.6 software according to the instructions in the *Genesys Voice Platform 7.6 Voice Application Reporter Deployment and Reference Manual*.
8. Stop the AppReporter scheduled task.

---

**Note:** The installation process automatically starts the AppReporter scheduled task.

---

9. Make the required configuration changes using the VAR Server Administration GUI. For more information about configuring VAR, see the *Genesys Voice Platform 7.6 Voice Application Reporter Deployment and Reference Manual*.
10. If using an MSSQL Database:

---

**Note:** Consult with your Database Administrator (DBA) for assistance.

---

- a. Open Query Analyzer, and log in as varuser .
  - b. In Query Analyzer, if upgrading from 7.2, open the `<installdir>\db_scripts\mssql\upgrade_var_mssql_7_2_0_to_7_5_0.sql` file.
  - c. If upgrading from 7.0.3, open the `<installdir>\db_scripts\mssql\upgrade_var_mssql_7_0_3_to_7_5_0.sql` file.
  - d. If upgrading from 6.5.5, open the `<installdir>\db_scripts\mssql\upgrade_var_mssql_6_5_5_to_7_5_0.sql` file.
  - e. From the database drop-down list, select VoiceAppRptr as the database.
  - f. Run the script.
11. If using an Oracle Database:
    - a. Login to Oracle SQL\*Plus as varuser .
    - b. Enter the following:  
`@<installdir>\db_scripts\oracle\upgrade_var_oracle_7_2_0_to_7_5_0.sql`

---

**Note:** VAR releases 6.5.5 and 7.0.3 are not available for the Oracle database.

---

- c. After the installation script successfully executes, type `commit;`

---

**Note:** Because there is no schema change between 7.5 and 7.6 in VAR Server, there are no upgrade scripts for 7.5 to 7.6 and the existing database can be used by 7.6.

---

12. Start the AppReporter scheduled task.



13. Verify that the VAR cycles are running.

## Solaris

To upgrade Voice Application Reporter (VAR) Server 7.2 to VAR Server 7.6:

1. Stop posting events to the VAR Server.
2. Run the VAR Server for two cycles in order to process all of the posted events. If events still exist, back up these files.
3. Stop the VAR Cron Job (see “Starting and Stopping Solaris Cron Jobs” on [page 1048](#)).
4. Back up the VAR log files.
5. Install the Genesys Voice Platform Voice Application Reporter 7.6 software and choose the upgrade option according to the instructions in the *Genesys Voice Platform 7.6 Voice Application Reporter Deployment and Reference Manual*.
6. Log in to Oracle SQL\*Plus as varuser .
7. Enter the following:  

```
@<installdir>\db_scripts\oracle\upgrade_var_oracle_7_2_0_to_7_5_0.sql
```

---

**Note:** Because there is no schema change between 7.5 and 7.6 in VAR Server, there are no upgrade scripts for 7.5 to 7.6 and the existing database can be used by 7.6.

---

8. After the installation script successfully executes, type `commit;`
9. Start the VAR Cron Job (see “Starting and Stopping Solaris Cron Jobs” on [page 1048](#)).
10. Verify that the VAR cycles are running.

---

## Upgrading VAR to 7.5

Genesys Voice Platform Voice Application Reporter 7.5 works with the 7.5 and 7.2 releases of the Genesys Voice Platform (GVP). For information on supported Operating Systems, software, and databases, see the *Genesys Voice Platform 7.5 Voice Application Reporter Deployment and Reference Manual*.

### Migration Considerations

1. You must migrate the platform to GVP 7.5.
2. Voice Application Reporter (VAR) is no longer included on the Studio DVD.

3. You must use Java Development Kit (JDK) release 1.4.2 or higher.
4. The subcallflow and transfer events have been renamed to IVR Actions, and the Subcallflow reports have been renamed to IVR Action reports.
5. VAR now supports the IBM DB2 UDB, and Oracle 10g R2 Databases.
6. In Studio 7.5, if the VXML Browser option is set to GVP 7.5, VAR events for Transfer blocks are generated as Start and Stop IVR Action events. This enables reporting of failure conditions. If you need to generate VAR events as in the same manner as previous versions, you must define the variable `reportitem_transferreportingflag` in the application START block, and set its value to 0.

## Windows

To upgrade Voice Application Reporter (VAR) Server 6.5.5, 7.0.3, 7.2 to VAR Server 7.5:

1. Stop posting events to the VAR Server.
2. Run the VAR Server for two cycles in order to process all the posted events. If events still exist, back up these files.
3. Stop the AppReporter scheduled task.
4. Backup the VAR Database.
5. Backup the VAR log files.
6. Uninstall the existing Genesys Voice Platform VAR components. For more detailed instructions, see the *Genesys Voice Platform 7.2 Genesys Studio Deployment Guide*, the *Genesys Voice Platform 7 Genesys Studio Deployment Guide*, or the *Genesys Voice Portal 6.5 Genesys Studio Developer's Guide*.
7. Install the Genesys Voice Platform Voice Application Reporter 7.5 software according to the instructions in the *Genesys Voice Platform 7.5 Voice Application Reporter Deployment and Reference Manual*.
8. Stop the AppReporter scheduled task.

---

**Note:** The installation process automatically starts the AppReporter scheduled task.

---

9. Make the required configuration changes using the VAR Server Administration GUI. For more information on configuring VAR, see the *Genesys Voice Platform 7.5 Voice Application Reporter Deployment and Reference Manual*.
10. If using an MSSQL Database:

---

**Note:** Consult with your Database Administrator (DBA) for assistance.

---

- a. Open Query Analyzer, and log in as varuser .
  - b. In Query Analyzer, if upgrading from 7.2, open the  
`<installdir>\db_scripts\mssql\upgrade_var_mssql_7_2_0_to_7_5_0.sql` file.  
 If upgrading from 7.0.3, open the  
`<installdir>\db_scripts\mssql\upgrade_var_mssql_7_0_3_to_7_5_0.sql` file.  
 If upgrading from 6.5.5, open the  
`<installdir>\db_scripts\mssql\upgrade_var_mssql_6_5_5_to_7_5_0.sql` file.
  - c. From the database drop-down list, select VoiceAppRptr as the database.
  - d. Run the script.
11. If using an Oracle Database:
- a. Login to Oracle SQL\*Plus as varuser.
  - b. Enter  
`@<installdir>\db_scripts\oracle\upgrade_var_oracle_7_2_0_to_7_5_0.sql`.

---

**Note:** VAR releases 6.5.5 and 7.0.3 are not available for the Oracle database.

---

- c. After the installation script successfully executes, type `commit;`
12. Start the AppReporter scheduled task.
13. Verify that the VAR cycles are running.

## Solaris

To upgrade Voice Application Reporter (VAR) Server 7.2 to VAR Server 7.5:

1. Stop posting events to the VAR Server.
2. Run the VAR Server for two cycles in order to process all the posted events. If events still exist, back up these files.
3. Stop the VAR Cron Job (see “Starting and Stopping Solaris Cron Jobs” on [page 1048](#)).
4. Backup the VAR log files.
5. Install the Genesys Voice Platform Voice Application Reporter 7.5 software and choose the upgrade option according to the instructions in the *Genesys Voice Platform 7.5 Voice Application Reporter Deployment and Reference Manual*.
6. Login to Oracle SQL\*Plus as varuser.

7. Enter  

```
@<installdir>\db_scripts\oracle\upgrade_var_oracle_7_2_0_to_7_5_0.sql.
```
8. After the installation script successfully executes, type `commit;`.
9. Start the VAR Cron Job (see “Starting and Stopping Solaris Cron Jobs” on [page 1048](#)).
10. Verify that the VAR cycles are running.

## Starting and Stopping Solaris Cron Jobs

1. Open a Solaris Login shell using the root account.
2. Type `crontab -e` to open the crontab file in the editor.
3. Locate the line `# Added by Voice Platform Application Reporter to invoke VAR consolidator every three minutes. Do not edit manually.`
4. To start the Cron Job, remove the comment (`#`) character on the next line so it reads as follows:  

```
0, 3, 6, 9, 12, 15, 18, 21, 24, 27, 30, 33, 36, 39, 42, 45, 48, 51, 54, 57 * * * * (cd /opt/genesys/gvp/cn/gvpapplicationreporter/php/var_engine; ./var_engine.sh) .
```
5. To stop the Cron job, add the comment (`#`) character on the next line so it reads as follows:  

```
0, 3, 6, 9, 12, 15, 18, 21, 24, 27, 30, 33, 36, 39, 42, 45, 48, 51, 54, 57 * * * * (cd /opt/genesys/gvp/cn/gvpapplicationreporter/php/var_engine; ./var_engine.sh) .
```
6. Save the file and quit the editor.

---

# Upgrading VAR to 7.2

## Windows

To upgrade Voice Application Reporter (VAR) Server 6.5.5 or 7.0.3 to VAR Server 7.2:

1. Stop posting events to the VAR Server.
2. Run the VAR Server for two cycles in order to process all the posted events. If events still exist, back up these files.
3. Stop the AppReporter scheduled task.
4. Backup the VAR Database.
5. Backup the VAR log files.

6. Uninstall the existing Genesys Voice Platform VAR components. For more detailed instructions, see the *Genesys Voice Platform Genesys Studio Deployment Guide*.
7. Install the Genesys Voice Platform Voice Application Reporter 7.2 software according to the instructions in the *Genesys Voice Platform 7.2 Genesys Studio Deployment Guide*.
8. Stop the AppReporter scheduled task.

---

**Note:** The installation process automatically starts the AppReporter scheduled task.

---

9. Complete the required configuration changes using the VAR Server Administration GUI. For more information on configuring VAR, see the *Genesys Voice Platform 7.5 Voice Application Reporter Deployment and Reference Manual*.
10. Open Query Analyzer, and log in as varuser .
11. In Query Analyzer, if upgrading from 7.0.3, open the  
`<installdir>\db_scripts\mssql\upgrade_var_mssql_7_0_3_to_7_2_0.sql`  
file.  
If upgrading from 6.5.5, open the  
`<installdir>\db_scripts\mssql\upgrade_var_mssql_6_5_5_to_7_2_0.sql`  
file.
12. From the database drop-down list, select VoiceAppRptr as the database.
13. Run the script.
14. Start the AppReporter scheduled task.
15. Verify that the VAR cycles are running.

---

## Upgrading VAR to 7.0.3

### Windows

To upgrade Voice Application Reporter (VAR) Server 6.5.5 to VAR Server 7.0.3:

1. Stop posting events to the VAR Server.
2. Run the VAR Server for two cycles in order to process all the posted events. If events still exist, back up these files.
3. Stop the AppReporter scheduled task.
4. Backup the VAR Database.
5. Backup the VAR log files.

6. Uninstall the existing Genesys Voice Platform VAR components. For more detailed instructions, see the *Genesys Voice Portal 6.5 Studio Deployment Guide*.
7. Install the Genesys Voice Platform Voice Application Reporter 7.0.3 software according to the instructions in the *Genesys Voice Platform 7 Genesys Studio Developer's Guide*.
8. Stop the AppReporter scheduled task.

---

**Note:** The installation process automatically starts the AppReporter scheduled task.

---

9. Complete the required configuration changes using the VAR Server Administration GUI. For more information on configuring VAR, see the *Genesys Voice Platform 7.5 Voice Application Reporter Deployment and Reference Manual*.
10. Open Query Analyzer, and log in as varuser .
11. In Query Analyzer open the following file:  
`<installdir>\db_scripts\mssql\upgrade_var_mssql_7_0_3.sql`
12. From the database drop-down list, select VoiceAppRptr as the database.
13. Run the script.
14. Start the AppReporter scheduled task.
15. Verify that the VAR cycles are running.



**Part**

# 19

## **Genesys Voice Platform 8.x Migration**

The chapters in this section describe the migration process from Genesys Voice Platform (GVP) 8.0 to later releases of GVP 8.x and the upgrade process from GVP 7.6 to GVP 8.1.

This part contains the following chapters:

- Chapter 61, “Upgrading to GVP 8.x,” on page 1053 describes the preliminary migration procedures and the migration order for migrating from GVP 8.0 to GVP 8.1 and from GVP 8.1 to GVP 8.1.1.
- Chapter 62, “Changes in GVP 8.1 and GVP 8.1.1,” on page 1059 provides information about the changes in components, configuration options, and the Reporting Server database in GVP 8.1 and GVP 8.1.1.
- Chapter 63, “Migration Procedures for GVP 8.x,” on page 1087 presents the procedures for migrating from GVP 8.0 to GVP 8.1 and from GVP 8.1 to GVP 8.1.1
- Chapter 64, “Migration Procedures for GVP 7.6,” on page 1101 presents the procedures for migrating from GVP 7.6 to GVP 8.1, component and Interactive Voice Response (IVR) Server configuration mappings, and Simple Network Management Protocol (SNMP) trap mappings.







## Chapter

# 61

## Upgrading to GVP 8.x

This chapter describes the preliminary migration procedures and the migration order for Genesys Voice Platform (GVP) 8.x. It contains the following sections:

- [Preliminary Migration Procedures, page 1053](#)
- [Order of Migration, page 1054](#)
- [Interoperability Among Components, page 1056](#)

---

### Preliminary Migration Procedures

The migration process includes the following preliminary procedures for GVP 8.x:

1. Review the “Migration Roadmap” chapter of this guide.
2. Examine the order in which the Genesys software required for GVP 8.1 and GVP 8.1.1 should be upgraded. See “Order of Migration” on [page 1054](#).
3. Examine the component changes for GVP. See Chapter 62 on [page 1059](#).

---

**Note:** The tables in [Chapter 62](#) describe changes that directly affect the migration of this product only.

For complete information about what’s new in the 8.1 and 8.1.1 releases of GVP and how these releases function, see the *Genesys Voice Platform 8.1 Deployment Guide*.

For a complete list of documentation relevant to the migration of this product, see “Reference Materials” on [page 1054](#).

---

4. Review the licensing requirements. Although GVP has no licensing requirements, there may be licensing requirements for associated products in the deployment, such as third-party speech engines or other Genesys

components. For more information about Genesys licensing requirements, see the information about licensing migration in the “Migration Roadmap” chapter of this guide.

5. Check the interoperability of the components of GVP 8.x during the upgrade procedures. See “Interoperability Among Components” on [page 1056](#).
6. Ensure that you have the required permissions to execute commands for GVP components in Genesys Administrator.

## Reference Materials

- *Genesys Voice Platform 8.1 Deployment Guide*
- *Genesys Voice Platform 8.1 User’s Guide*
- *Genesys Voice Platform 8.1 Application Migration Guide*
- *Voice Platform Solution 8.1 Integration Guide*
- *Genesys Voice Platform 8.1 Configuration Options Reference*
- *Genesys Voice Platform 8.1 Troubleshooting Guide*

For additional GVP-related reference materials, see the *Genesys Voice Platform 8.1 Deployment Guide*.

---

## Order of Migration

The information in this section is specific to the application processes and components that enable or support GVP 8.1 and GVP 8.1.1.

Migrate or upgrade the application components of GVP, the other enabling software, and relevant data for this GVP solution in the following order:

---

**Note:** For the specific procedures that provide more detail about these overview steps, see “Procedures to Migrate GVP 8.0” on [page 1088](#) and “Procedures to Migrate GVP 8.1” on [page 1092](#).

---

### 1. Migrate Management Framework.

Management Framework is the foundation for all Genesys products, solutions, and options. Upgrade the Management Framework components as follows:

- When migrating to GVP 8.1, upgrade Genesys Administrator to release 8.0.1.
- When migrating to GVP 8.1.1, upgrade Genesys Administrator to release 8.0.11.

For information about migrating the layers and components of Management Framework, see the “Framework Migration” part of this guide.

---

**Note:** You must migrate to Genesys Administrator 8.0.1 or 8.0.11 before installing the GVP 8.1 or 8.1.1 components.

---

If you plan to upgrade Configuration Server, Genesys recommends that you first back up the Configuration Layer to an XML file. For more information, see [Step 1](#) of the preliminary migration procedures on [page 1087](#).

2. Upgrade other prerequisite Genesys components (SIP Server, Composer), if required. See “Compatibility Among Components” on [page 1057](#).

When upgrading many components, determine if the first component you upgrade is backward compatible with the GVP components that have not been upgraded yet. See the *Genesys 8 Interoperability Guide*.

3. Migrate GVP:

#### Migrating to GVP 8.1

- To release 8.1 (for full details, see Chapter 63 on [page 1087](#)).
  - Back up the configurations of the GVP 8.0 component `Application` objects.
  - Stop GVP.
  - Uninstall the GVP 8.0 components.
  - Create and configure new, 8.1 GVP `Application` objects, and install the GVP `Applications` on their hosts.
  - If you installed the Media Control Platform release 8.1 in a different directory from the 8.0 `Application`, update the local path to the `vggrammarbase`, the web server's virtual directory, in Microsoft Internet Information Server (IIS). Restore any other custom configuration for the Media Control Platform at this point.
  - Back up the Reporting Server database.
  - Upgrade the Reporting Server database.
  - Start GVP 8.1.
  - Verify proper operation of GVP 8.1 by checking its log for errors.

#### Migrating to GVP 8.1.1

- To release 8.1.1 (for full details, see Chapter 63 on [page 1087](#)):
  - Back up the configurations of the GVP 8.1 component `Application` objects.
  - Stop GVP.
  - Uninstall the GVP 8.1 components.
  - Create and configure new, 8.1.1 GVP `Application` objects, and install the GVP `Applications` on their hosts.

- If you installed the Media Control Platform release 8.1.1 in a different directory from the 8.1 Application, update the local path to the `vggrammarbase`, the web server's virtual directory, in Microsoft Internet Information Server (IIS) (or the Apache Web Server if you are installing on Linux). Restore any other custom configuration for the Media Control Platform at this point.

---

**Note:** Beginning with GVP release 8.1, Linux is supported.

---

- Back up the Reporting Server database.
- Upgrade the Reporting Server database.
- Start GVP 8.1.1.
- Verify proper operation of GVP 8.1.1 by checking its log for errors.

---

## Interoperability Among Components

The term *interoperable* means that different versions of Genesys solutions, components, or options can work together compatibly during the migration process.

*Interoperability* of Genesys products can occur at two levels of migration:

- **Interoperability at the suite level** means combining different releases of solutions and options during the migration process.

**Example:** You can migrate to the Management Layer of Framework 8.0.1 while still using 7.x or 8.0 components. For information about suite-level interoperability, see the *Genesys 7 Interoperability Guide* and the *Genesys 8 Interoperability Guide*.

- **Interoperability at the solution level** means combining different releases of the components of a particular solution while upgrading them sequentially during the migration process.

The mixture of components may include the executable files, applications, routing strategies, scripts, and data that make up a particular solution.

As you upgrade each of the components in sequence, you will need to know whether it is backward-compatible with the other components of GVP.

**Example:** If you have four components to upgrade, determine whether the first component you upgrade to release 8.1 will be backward-compatible with the three 8.0 components you have not yet upgraded.

The following section provides important information about GVP interoperability at the suite level and the solution level.

## Compatibility Among Components

This section describes compatibility among GVP components and Voice Platform Solution (VPS) components.

### Components in 8.1

GVP 8.1 includes the following component installation packages (IPs):

- VP Resource Manager 8.1
- VP Media Control Platform 8.1 (includes software to represent the optional Media Resource Control Protocol version 1 [MRCPv1] or MRCP version 2 [MRCPv2] speech engines in Genesys Framework)
- VP Call Control Platform 8.1
- VP Third-Party Squid 8.1 (unchanged from 8.0)
- VP Fetching Module 8.1
- VP Reporting Server 8.1
- VP Computer Telephony Integration Connector (CTIC) 8.1 (new component)
- VP Management Information Bases (MIBs) 8.1

Voice Platform Solution (VPS) 8.1 also includes:

- Management Framework 8.0 and Genesys Administrator 8.0.1
- SIP Server 8.0.1
- Composer 8.0.2

If you will be adding the CTIC to your deployment for full computer-telephony integration (CTI) functionality through IVR Server, the minimum required release of Genesys IVR Server is release 7.5.

### Components in 8.1.1

GVP 8.1.1 includes the following component installation packages (IPs):

- VP Resource Manager 8.1.1
- VP Media Control Platform 8.1.1 (includes software to represent the optional Media Resource Control Protocol version 1 [MRCPv1] or MRCP version 2 [MRCPv2] speech engines in Genesys Framework)
- VP Call Control Platform 8.1.1
- VP Third-Party Squid 8.1.1 (unchanged from 8.0)
- VP Fetching Module 8.1.1
- VP Reporting Server 8.1.1
- VP Supplementary Services Gateway 8.1.1 (new component)
- VP Computer Telephony Integration Connector (CTIC) 8.1.1

- VP Management Information Bases (MIBs) 8.1.1

Voice Platform Solution (VPS) 8.1.1 also includes:

- Management Framework 8.0 and Genesys Administrator 8.0.11
- SIP Server 8.0.1
- Composer 8.0.2

If you will be adding the CTIC to your deployment for full computer-telephony integration (CTI) functionality through IVR Server, the minimum required release of Genesys IVR Server is release 7.5.

---

**Note:** Common components like the Resource Manager, Reporting Server, Genesys Administrator, and Management Framework must be updated to the latest version if they are deployed in mixed version environments. Consequently, old and new versions of the Media Control Platform, Call Control Platform, Fetching Module, and CTI Connector can interoperate with updated versions of the common components.

---

#### **Reporting Server Database**

Each GVP release has its own Reporting Server database schema version, and each release can work only with its own database schema version.

---

**Note:** For an overview about migration issues, see the “Overview of Migration” chapter of this guide.

---



## Chapter

# 62

## Changes in GVP 8.1 and GVP 8.1.1

This chapter provides information that you need to upgrade the components and configuration options of Genesys Voice Platform (GVP) from release 8.0 to 8.1 and from release 8.1 to 8.1.1. This chapter discusses only those changes (additions, deletions, and modifications) in the product that may need to be addressed during the migration process.

The product documentation for each release contains a comprehensive list of changes from release to release. In particular, review the “New in This Release” section of the *Genesys Voice Platform 8.1 Deployment Guide*.

This chapter contains the following sections:

- [Changes in GVP 8.1, page 1059](#)
- [Changes in GVP 8.1.1, page 1074](#)

---

## Changes in GVP 8.1

The changes in GVP 8.1 are described in the following sections:

- [8.1 Component Changes on page 1060](#)
- [8.1 Configuration Option Changes on page 1065](#)
- [8.1 Reporting Server Database Changes on page 1073](#)

For more information about all the new features and functions in release 8.1, see the *Genesys Voice Platform 8.1 Deployment Guide*. For more detailed information about configuring GVP to implement the features and functions, see the *Genesys Voice Platform 8.1 User's Guide* and the *Voice Platform Solution 8.1 Integration Guide*.

## 8.1 Component Changes

Table 171 shows the component changes in GVP from release 8.0 to 8.1.

**Table 171: Component Changes from GVP 8.0 to GVP 8.1**

Current Component Name	Type of Change	Details
Resource Manager, Media Control Platform, Call Control Platform, Fetching Module and Squid, Reporting Server, and Management Information Bases (MIBs)	Operating system support added	Support for Linux: <ul style="list-style-type: none"> <li>Red Hat Enterprise Linux Advanced Server 4.0, 32-bit version</li> </ul>
Media Control Platform	New application modules	The Legacy GVP Interpreter (GVPI), a new Voice Extensible Markup Language (VoiceXML) interpreter on the Media Control Platform, enables legacy GVP 7.6 VoiceXML and Telera XML (TXML) applications to be used with GVP 8.1. New PageCollector and PopGateway modules on the Media Control Platform control the fetching and processing behavior of the GVPI, respectively. The GVPI is available only for Windows. For information about migrating legacy applications to use the GVPI, see the <i>Genesys Voice Platform 8.1 Application Migration Guide</i> .
	Third-party speech engine support added	<ul style="list-style-type: none"> <li>IBM WebSphere Voice Server (WVS) 5.1.3.3 or later (Automatic Speech Recognition [ASR] or Text-to-Speech [TTS])</li> <li>Telisma Telispeech 2.0 SP1 (ASR only)</li> </ul>
	New features	The Media Control Platform now provides: <ul style="list-style-type: none"> <li>Support for the NETANN prompt announcement service (RFC 4240). The service is initiated when the incoming Session Initiation Protocol (SIP) INVITE message contains the play parameter in the SIP Request-URI.</li> <li>Failover handling for SIP REFERJOIN (REFER with Replaces) transfer.</li> <li>Call Progress Analysis (CPA) handling through SIP INFO messages.</li> </ul>



**Table 171: Component Changes from GVP 8.0 to GVP 8.1 (Continued)**

Current Component Name	Type of Change	Details
Media Control Platform (continued)	New features (continued)	<ul style="list-style-type: none"> <li>• Inband DTMF detection.</li> <li>• Support for requesting Video I-Frames, which enables video recording to start.</li> <li>• Support for the use of vendor-specific TTS parameters.</li> <li>• Simultaneous support of the Next-Generation Interpreter (NGI) and the new GVPi.</li> <li>• (NGI only) Manual ASR session release.</li> </ul>
	Functionality changed	For the NGI, the Maintainer e-mail function is now disabled by default. To implement the Maintainer function, you must explicitly enable it in configuration (the <code>maintainer.enabled</code> configuration option in the <code>vxmli</code> section).
	Behavior changed	For the NGI, if a particular input mode ( <code>voice</code> or <code>DTMF</code> ) is not specified, then input of that type of input mode is ignored, and the platform generates a <code>nomatch</code> event. Previously, if the <code>inputmodes</code> property was specified as <code>voice</code> , and <code>DTMF</code> input was received, the Media Control Platform generated a <code>noinput</code> event.
	Directories changed	<ul style="list-style-type: none"> <li>• The <code>&lt;MCP installation path&gt;/audio</code> directory contains only the following subdirectories: <ul style="list-style-type: none"> <li>• <code>dtmf</code>—Stores standard DTMF tones.</li> <li>• <code>default_audio</code>—Stores standard information or error prompts that are used by the Media Control Platform.</li> </ul> </li> </ul> <p>All other prompts, including those used by the sample VoiceXML applications, have been removed. The <code>value</code>, <code>prompts</code>, and <code>effects</code> subdirectories are no longer created.</p> <ul style="list-style-type: none"> <li>• A <code>prompts</code> subdirectory in the <code>&lt;MCP installation path&gt;/samples</code> directory contains the audio files that are used by the sample VoiceXML applications that are stored in the <code>samples</code> directory.</li> </ul>
MRCP Clients	New Application Templates	For convenience, separate Application Templates for Nuance, IBM, and Telisma MRCP clients provide suitable, vendor-specific default settings for MRCPv1 and MRCPv2 ASR and TTS.

**Table 171: Component Changes from GVP 8.0 to GVP 8.1 (Continued)**

Current Component Name	Type of Change	Details
CTI Connector (CTIC)	New component	<p>The CTIC integrates GVP with IVR Server to support full computer-telephony integration (CTI) functionality for legacy GVPi applications and NGI applications with CTI extensions, and for certain switch configurations for which the architecture requires CTI through IVR Server. The CTIC provides connectivity to the larger Genesys suite of products through the IVR Server XML interface. The CTIC is available only for Windows.</p>
Resource Manager	Functionality changed (Windows)	<p>The implementation of High Availability (HA) for the Resource Manager has changed. As in GVP 8.0, the Resource Manager uses cluster virtual IP technology, so that highly available Resource Manager nodes appear as a single entity to the other GVP components. In GVP 8.1, the nodes share session data for hot-standby HA. The Resource Manager nodes establish primary and secondary status between themselves, and the deployment no longer includes a Cluster Manager. GVP 8.1 also supports HA for Linux.</p>
	Functionality enhanced or modified	<p>Existing functionality has been modified, or else it has been extended to support additional features:</p> <ul style="list-style-type: none"> <li>• There are now four types of resource groups: <ul style="list-style-type: none"> <li>• Media Control Platform</li> <li>• Call Control Platform</li> <li>• Gateway</li> <li>• CTI Connector</li> </ul> </li> <li>• A new service type, Announcement, has been added to the types of services that an IVR Profile can provide.</li> <li>• IVR Profile policies can now be configured for two levels of burst thresholds to temporarily exceed the configured usage limits.</li> <li>• The Resource Manager now supports call information policies, for rule-based determination of whether to accept, reject, or play scripts for incoming calls, based on the ANI, DNIS, or User-Agent information of the call.</li> </ul>

**Table 171: Component Changes from GVP 8.0 to GVP 8.1 (Continued)**

Current Component Name	Type of Change	Details
Call Control Platform	Features enhanced	<ul style="list-style-type: none"> <li>• Operational Reporting (OR) is now supported.</li> <li>• Two new device profiles have been added:               <ul style="list-style-type: none"> <li>• eyeBeam</li> <li>• Kapanga</li> </ul> </li> </ul>
Reporting Server	New feature	<p>The Reporting Server now supports HA through a primary/backup configuration. There are two models for clustering the ActiveMQ Java Message Service (JMS) queues, to provide HA for Reporting Clients:</p> <ul style="list-style-type: none"> <li>• Shared Storage Solution (Windows only)—Both Reporting Server instances are connected to a shared storage solution.</li> <li>• Independent Solution (Windows and Linux)—Both Reporting Server instances use independent message stores, but only the primary server activates its message store.</li> </ul>
	New or enhanced Reporting features	<p>Selected enhanced Reporting features include:</p> <ul style="list-style-type: none"> <li>• CTI Summary reporting</li> <li>• Port utilization dashboard, based on available Call Detail Record (CDR) information:               <ul style="list-style-type: none"> <li>• Component Utilization</li> <li>• IVR Profile Utilization</li> </ul> </li> <li>• Call Arrival and Call Peak reporting for the Call Control Platform</li> <li>• Burst reporting:               <ul style="list-style-type: none"> <li>• Profile burst limits displayed in the Voice Platform Dashboard</li> <li>• Profile/Tenant limits and usage displayed in real-time and historical CDR reports (Active Call List and Historical Call Browser)</li> </ul> </li> <li>• Enhanced CDR reporting:               <ul style="list-style-type: none"> <li>• Call State information in real-time CDR reports</li> <li>• Call Disposition information in historical CDR reports</li> <li>• Queue Wait Time information in cases where the call was abandoned or transferred to an agent</li> </ul> </li> </ul>

**Table 171: Component Changes from GVP 8.0 to GVP 8.1 (Continued)**

Current Component Name	Type of Change	Details
Reporting Server (continued)	Report changed	For data compatibility reasons, the GVP 8.1 IVR Action Usage summary report does not display a breakdown of IVR results by reason for data that was generated by the GVP 8.0 deployment. However, the report does display the result reason breakdown for new data that is generated by GVP 8.1 IVR actions.
Genesys Administrator (GVP-specific functions on the Provisioning tab)	Functionality modified/enhanced	New or modified wizards: <ul style="list-style-type: none"> <li>• Installation Wizard—Enables you to install single or multiple instances of GVP components with a basic configuration.</li> <li>• Create Application Wizard—Enables you to import the Application Templates and metadata, and then create and configure component Applications.</li> <li>• IVR Profile Wizard—Enables you to provision voice or call control applications for GVP.</li> <li>• Resource Group Wizard—Enables you to configure the resource groups from which the Resource Manager will select the resource to perform a particular service for a particular usage instance of an IVR Profile.</li> </ul>
	Enhanced usability feature	Links in the new Monitoring panel on the Provisioning > Voice Platform > IVR Profiles page enable you to link directly to reports about the selected IVR Profile(s) on the Monitoring tab.
Genesys Administrator (GVP-specific functions on the Monitoring tab)	New feature	The Voice Platform Dashboard is new display item in the Voice Platform view. The Voice Platform Dashboard summarizes real-time and historical information about IVR and platform usage to provide a snapshot of current utilization of the IVR Profiles and the call-processing components (Resource Manager, Media Control Platform, and Call Control Platform) in the GVP deployment. Flexible user configuration enables you to customize the display.

**Table 171: Component Changes from GVP 8.0 to GVP 8.1 (Continued)**

Current Component Name	Type of Change	Details
Genesys Administrator (GVP-specific functions on the Monitoring tab) (continued)	Enhanced usability features	<ul style="list-style-type: none"> <li>Filter enhancements for viewing reports</li> <li>Call Summary and Call Peaks reports broken into separate reports, by IVR Profile and Component, respectively</li> </ul> <p>See also the new or enhanced Reporting features described for the Reporting Server on <a href="#">page 1063</a>.</p>

## 8.1 Configuration Option Changes

The following tables describe the changes to the configuration options, or parameters, for specific components of GVP 8.1

- Resource Manager and IVR Profiles—Table 172 on [page 1065](#)
- Media Control Platform—Table 173 on [page 1068](#)
- MRCP Clients—Table 174 on [page 1070](#)
- Call Control Platform—Table 175 on [page 1071](#)
- Reporting Server—Table 176 on [page 1072](#)
- Fetching Module—Table 177 on [page 1073](#)

For descriptions and default values of all GVP 8.1 configuration options, see the *Genesys Voice Platform 8.1 Configuration Options Reference*.

[Table 172](#) describes Resource Manager and IVR Profile changes.

**Table 172: Resource Manager Configuration Option Changes in GVP 8.1**

Option/Section Name	Type of Change	Details
cluster section	New section	Parameters determine HA behavior. Some parameters are the equivalents of former Cluster Manager options. The parameters that used to be configured by the <code>cluster_ip</code> and <code>cluster_hotstandby</code> options in the <code>rm</code> section are now configured by equivalent options in the <code>cluster</code> section.
cmserviceagent section	Section removed	
rm section	Options removed	
rm section	New option added	<ul style="list-style-type: none"> <li><code>sip-header-for-cti-dnis</code>—For requests that come from CTIC, specifies the header from which the Resource Manager will retrieve the DNIS, to identify which IVR Profile to use.</li> </ul>

**Table 172: Resource Manager Configuration Option Changes in GVP 8.1 (Continued)**

Option/Section Name	Type of Change	Details
ems section	New options added	<p>The following parameters provide additional options for controlling OR and CDR reporting behavior:</p> <ul style="list-style-type: none"> <li>rc.ors.local_queue_max</li> <li>rc.cdr.local_queue_max</li> <li>rc.cdr.queue_size_limit</li> <li>rc.ors.queue_size_limit</li> <li>rc.cdr.max_reconnect_interval</li> <li>rc.ors.max_reconnect_interval</li> <li>rc.cdr.max_batch_time</li> <li>rc.ors.max_batch_time</li> </ul>
	Options removed	<ul style="list-style-type: none"> <li>rc.batch_size</li> <li>trace_flag</li> </ul>
<Resource Group> section	Options and option values changed	For information about the valid options for GVP 8.1, see the <i>Genesys Voice Platform 8.1 User's Guide</i> .
rc.ors.batch_size option in the ems section	Default value changed	The default value is now 500 (it used to be 1). This option specifies the number of OR messages that will be queued by the reporting client before they are sent to the Reporting Server. This parameter was formerly hidden.
log section	Default values changed	The default values of some log parameters have changed, and additional parameters are now specified by default. For information about the default log settings in GVP 8.1, see the section in the <i>Genesys Voice Platform 8.1 User's Guide</i> about configuring logging.
snmp section	New section	The single parameter, timeout, specifies the maximum amount of time that SNMP waits for a new task. The default is 100 milliseconds.
<b>IVR Profile</b>		
gvp.general section	New option value, and new option added	<ul style="list-style-type: none"> <li>service-type—A new option value, announcement, has been added, for IVR Profiles that provide NETANN announcement services.</li> <li>toll-free-number—New option identifies the toll-free number associated with this IVR Profile.</li> </ul>
gvp.service-prerequisite section	New option added	announcement-url—The URL to the announcement audio file.

**Table 172: Resource Manager Configuration Option Changes in GVP 8.1 (Continued)**

Option/Section Name	Type of Change	Details
gvp.policy section	New options added	<ul style="list-style-type: none"> <li>• Parameters for announcement service that are equivalent to the management policy parameters for the other service types:               <ul style="list-style-type: none"> <li>• announcement-allowed</li> <li>• announcement-forbidden-respcode</li> <li>• announcement-usage-limit</li> <li>• announcement-usage-limit-per-session</li> <li>• announcement-usage-limit-exceeded-respcode</li> <li>• announcement-forbidden-set-alarm</li> <li>• announcement-usage-limit-exceeded-set-alarm</li> </ul> </li> <li>• Parameters for burst policies that are equivalent to other usage limit parameters:               <ul style="list-style-type: none"> <li>• burst-allowed</li> <li>• burst-set-alarm</li> <li>• level2-burst-limit</li> <li>• level3-burst-limit</li> <li>• &lt;type&gt;-level2-burst-limit</li> <li>• &lt;type&gt;-level3-burst-limit</li> </ul>               where &lt;type&gt; is inbound, outbound, voicexml, ccxml, conference, or announcement             </li> </ul>
	Options removed	<ul style="list-style-type: none"> <li>• external-sip-allowed</li> <li>• external-sip-forbidden-respcode</li> <li>• external-sip-forbidden-set-alarm</li> <li>• external-sip-usage-limit-exceeded-set-alarm</li> </ul>
gvp.policy.call-info section	New section	Parameters to specify the call information policies. Each rule-<n> parameter specifies a rule to be matched against the DNIS, ANI, or User-Agent, as obtained from the SIP message, to determine whether to accept, reject, or play a script for incoming calls.
gvp.service-parameters section	New options added	<ul style="list-style-type: none"> <li>• voicexml.gvp.appmodule</li> <li>• voicexml.gvpi.*—Various parameters to migrate legacy VoiceXML applications for the GVPi</li> <li>• cti.defaultagent</li> <li>• cti.transferoncti</li> </ul>

Table 173 describes Media Control Platform changes.

**Table 173: Media Control Platform Configuration Option Changes in GVP 8.1**

Option/Section Name	Type of Change	Details
cpa section	New section	Parameters define behavior for CPA detection.
Netann section	New section	Parameters determine default behavior for NETANN prompt announcement service.
PageCollector section	New section	Parameters determine fetching and caching behavior for the GVPi.
PopGateway1 section	New section	Parameters determine processing behavior for the GVPi.
delay_for_dtmf option in the asr section	Default value changed	The default delay between the last DTMF input and the start of the next Automatic Speech Recognition (ASR) has been changed from 250 milliseconds to 0.
ems section	New options added	The following parameters provide additional options for controlling OR and CDR reporting behavior: <ul style="list-style-type: none"> <li>rc.local_queue_max</li> <li>rc.cdr.local_queue_max</li> <li>rc.ors.local_queue_max</li> </ul>
	Options removed	<ul style="list-style-type: none"> <li>trace_flag</li> <li>dc.trace_flag</li> </ul>



**Table 173: Media Control Platform Configuration Option Changes in GVP 8.1 (Continued)**

Option/Section Name	Type of Change	Details
mpc section	New options added	<ul style="list-style-type: none"> <li><code>dtmf.pauseduration</code>—The duration, in milliseconds, of a DTMF pause. Default value: 200</li> <li><code>mediamgr.rec_iframe_delay_threshold</code>—For video recording with audio, the amount of time before video filling is required, to prevent loss of synchronization when audio is being received ahead of an I-Frame. Default value: 160</li> <li><code>record.defaultdtmfhandling</code>—Specifies the recording behavior with regard to DTMF input in a Simple Recording. Default value: as-is</li> <li><code>rtp.request_iframe</code>—Enables or disables the requesting of video intra-frames. Default value: 1 (enabled)</li> </ul>
	Default values changed	<ul style="list-style-type: none"> <li><code>asr.codec</code>—New default value: <code>pcmu telephone-event</code></li> <li><code>controlthreadlevel</code>—New default value: <code>HIGHEST</code></li> </ul>
	Option removed	<code>mixer.maxsilencethreshold</code>
sessmgr section	New options added	<ul style="list-style-type: none"> <li><code>default_vxml_interpreter</code></li> <li><code>LegacyGVP.VXML-LGVP</code></li> <li><code>mrt.sendsdpininvite</code></li> </ul>
sip section	Option removed	<code>confserver</code>
	New options added	<ul style="list-style-type: none"> <li><code>defaultfrom</code></li> <li><code>referxfertryoutbound</code></li> <li><code>referxferwaitnotifyother</code></li> </ul>
vrn section	Default value changed	<code>client.modules</code> —New default value: <code>MRCPV1 MRCPV2 MRCP_DTMFRECOGNIZER</code>
vxml section	New options added	<ul style="list-style-type: none"> <li><code>asr.defaultengine</code></li> <li><code>asr.release_on_transfer</code></li> <li><code>maintainer.enabled</code></li> <li><code>messaging.enabled</code></li> <li><code>tts.defaultengine</code></li> </ul>

**Table 173: Media Control Platform Configuration Option Changes in GVP 8.1 (Continued)**

Option/Section Name	Type of Change	Details
vxmli section (continued)	Default values changed	<ul style="list-style-type: none"> <li>beep.uri—New default value: <code>file://\$InstallationRoot\$/audio/ulaw/default_audio/endpointprompt.vox</code></li> <li>builtin_path—New default value: <code>\$InstallationRoot\$/audio/ulaw/</code></li> </ul>
rc.ors.batch_size option in the ems section	Default value changed	The default value is now 500 (it used to be 1). This option specifies the number of OR messages that will be queued by the reporting client before they are sent to the Reporting Server. This parameter was formerly hidden.
log section	Default values changed	The default values of some log parameters have changed, and additional parameters are now specified by default. For information about the default log settings in GVP 8.1, see the section in the <i>Genesys Voice Platform 8.1 User's Guide</i> about configuring logging.
snmp section	New section	The single parameter, <code>timeout</code> , specifies the maximum amount of time that SNMP waits for a new task. The default is 100 milliseconds.

[Table 174](#) describes MRCP Client changes.

**Table 174: MRCP Client Configuration Option Changes in GVP 8.1**

Option/Section Name	Type of Change	Details
provision section	Default values changed	<p>The default values of the following options are now empty:</p> <ul style="list-style-type: none"> <li><code>vrn.client.resource.address</code></li> <li><code>vrn.client.resource.name</code></li> <li><code>vrn.client.resource.port</code></li> <li><code>vrn.client.resource.uri</code></li> </ul>

Table 175 describes Call Control Platform changes.

**Table 175: Call Control Platform Configuration Option Changes in GVP 8.1**

Option/Section Name	Type of Change	Details
ccxml section	Default values changed	<ul style="list-style-type: none"> <li>max_num_sessions—New default value: 6000</li> <li>max_num_documents—New default value: 6000</li> <li>max_conn_per_session—New default value: 100</li> <li>max_conf_per_session—New default value: 100</li> </ul>
mediacontroller section	Default values changed	<ul style="list-style-type: none"> <li>sipproxy—New default value: 127.0.0.1:5060</li> <li>bridge_server—New default value: 127.0.0.1:5070</li> <li>sip.allowedunknownheaders (formerly in the ccpcxml section)—New default value: Warning Reason</li> <li>inbound_allowed_media—New default value: dynamic</li> </ul>
	Valid value added	sip.allowedunknownheaders—The asterisk (*) is a new, wildcard value, which specifies that all unknown headers are allowed. You cannot combine the wildcard value with other valid values.
	Options moved	The sip.allowedunknownheaders and allow_dialog_transfer options have been moved from the ccpcxml section.
mediatrller section	Section removed	Parameters have been moved into the mediacontroller section.
ems section	New options added	<p>The following parameters control OR reporting behavior:</p> <ul style="list-style-type: none"> <li>rc.ors.local_queue_max</li> <li>rc.ors.local_queue_path</li> <li>rc.ors.local_queue_max</li> <li>rc.ors.msg_broker_uri</li> <li>ors.reportinginterval</li> </ul>
	Options removed	<ul style="list-style-type: none"> <li>trace_flag</li> <li>dc.trace_flag</li> </ul>

**Table 175: Call Control Platform Configuration Option Changes in GVP 8.1 (Continued)**

Option/Section Name	Type of Change	Details
log section	Default values changed	The default values of some log parameters have changed, and additional parameters are now specified by default. For information about the default log settings in GVP 8.1, see the section in the <i>Genesys Voice Platform 8.1 User's Guide</i> about configuring logging.
snmp section	New section	The single parameter, <code>timeout</code> , specifies the maximum amount of time that SNMP waits for a new task. The default is 100 milliseconds.

Table 176 describes Reporting Server changes.

**Table 176: Reporting Server Configuration Option Changes in GVP 8.1**

Option/Section Name	Type of Change	Details
cdr section	Default value changed	<code>db-maintenance-batch-size</code> —New default value: 5
messaging section	Option replaced	The <code>activemq.broker</code> option has been replaced by the <code>port</code> option, which specifies the listening port for the ActiveMQ JMS broker that receives incoming data from Reporting Clients. The default port is still 61616.
persistence section	Default value changed	<code>hibernate.remote.dialect</code> —New default value: No default value specified.
persistence section (continued)	Options replaced	<ul style="list-style-type: none"> <li>The <code>hibernate.remote.xaDataSourceClassName</code> option has been replaced by <code>hibernate.remote.driver</code>. There is no default value.</li> <li>The <code>hibernate.remote.xaDataSourceProperties</code> option has been replaced by the following options: <ul style="list-style-type: none"> <li><code>hibernate.remote.url</code></li> <li><code>hibernate.remote.database</code></li> <li><code>hibernate.remote.user</code></li> <li><code>password</code></li> </ul> There are no default values.</li> </ul>

**Table 176: Reporting Server Configuration Option Changes in GVP 8.1 (Continued)**

Option/Section Name	Type of Change	Details
reporting section	New options added	<ul style="list-style-type: none"> <li>hostname</li> <li>port</li> <li>protocol</li> <li>username</li> <li>password</li> </ul>
https and https_key sections	New sections	Parameters specify the properties of the Reporting Server keystore that is used by HTTPS connectors. Keys and certificates are stored in the keystore.
log section	Default values changed	The default values of some log parameters have changed, and additional parameters are now specified by default. For information about the default log settings in GVP 8.1, see the section in the <i>Genesys Voice Platform 8.1 User's Guide</i> about configuring logging.

[Table 177](#) describes Fetching Module changes.

**Table 177: Fetching Module Configuration Option Changes in GVP 8.1**

Option/Section Name	Type of Change	Details
ems section	Option removed	trace_flag
log section	Default values changed	The default values of some log parameters have changed, and additional parameters are now specified by default. For information about the default log settings in GVP 8.1, see the section in the <i>Genesys Voice Platform 8.1 User's Guide</i> about configuring logging.
snmp section	New section	The single parameter, timeout, specifies the maximum amount of time that SNMP waits for a new task. The default is 100 milliseconds.

## 8.1 Reporting Server Database Changes

The Reporting Server database schema version is always the same as the release number of the Reporting Server installation package (IP).

[Table 178](#) summarizes the major changes to the Reporting Server database schema from GVP 8.0 to GVP 8.1.

**Table 178: Reporting Server Database Schema Changes from GVP 8.0 to GVP 8.1**

Type of Change	Details
New tables	<ul style="list-style-type: none"> <li>• CCP_ARRIVALS</li> <li>• CCP_PEAKS</li> </ul>
Tables modified	<p>The PERIOD_IVR_ACTION_STATS table has been modified as follows:</p> <ul style="list-style-type: none"> <li>• The totalSuccess, totalFailed, and totalUnknown columns have been deleted.</li> <li>• The following new columns have been added:               <ul style="list-style-type: none"> <li>♦ result</li> <li>♦ reason</li> <li>♦ count</li> </ul> </li> </ul>
	<p>The following columns have been added to the RM_CDR table:</p> <ul style="list-style-type: none"> <li>• USAGE_PROFILE</li> <li>• BURST_PROFILE</li> <li>• USAGE_TENANT</li> <li>• BURST_TENANT</li> <li>• CALL_DISPOSITION</li> <li>• QUEUE_WAIT_TIME</li> <li>• CALL_STATE</li> </ul>

---

## Changes in GVP 8.1.1

The changes in GVP 8.1.1 are described in the following sections:

- [8.1.1 Component Changes](#) on page 1075
- [8.1.1 Configuration Option Changes](#) on page 1078
- [8.1.1 Reporting Server Database Changes](#) on page 1084

For more information about all the new features and functions in release 8.1.1, see the *Genesys Voice Platform 8.1 Deployment Guide*. For more detailed information about configuring GVP to implement the features and functions, see the *Genesys Voice Platform 8.1 User's Guide* and the *Voice Platform Solution 8.1 Integration Guide*.

## 8.1.1 Component Changes

Table 179 shows the component changes in GVP from release 8.1 to 8.1.1.

**Table 179: Component Changes from GVP 8.1 to GVP 8.1.1**

Current Component Name	Type of Change	Details
Resource Manager, Media Control Platform, Call Control Platform, Fetching Module and Squid, and Reporting Server	New features	GVP now supports outbound calling campaign execution using the Supplementary Services Gateway.
	Enhanced functionality	When installed on Windows, GVP components are now installed as Services and can be configured to startup automatically.
Media Control Platform	New features	<ul style="list-style-type: none"> <li>The Media Control Platform now provides: <ul style="list-style-type: none"> <li>Call Progress Analysis (CPA) with three states of progress detection for outbound calling, with an Media Server Markup Language (MSML) record attribute that determines whether the media received during CPA is recorded.</li> <li>A new MSML interface for control of media server functions to support outbound calling. VoiceXML dialogs that are invoked using MSML are processed by the NGI.</li> <li>Support for extracting Session Description Protocol (SDP) content from an incoming SIP message with the content-type, multipart/mixed (as defined in RFC 2046).</li> <li>Support for the P-Asserted-Identity and P-Caller-Party-ID headers in the initial SIP INVITE message as defined in RFC 3455.</li> </ul> </li> <li>The GVPi and the NGI now support AT&amp;T transfer connect (inband only).</li> </ul>
	Enhancements to application modules	<ul style="list-style-type: none"> <li>The NGI has three new security enhancements: <ul style="list-style-type: none"> <li>A configurable size limit can be imposed on documents, which prevents rogue applications from using excess memory with large documents.</li> <li>A configurable size limit can be imposed on the temp files folder, which prevents this folder from becoming too large.</li> <li>A configurable depth limit can be imposed the subdialog stack on a per-application, per-tenant basis.</li> </ul> </li> </ul>

**Table 179: Component Changes from GVP 8.1 to GVP 8.1.1 (Continued)**

Current Component Name	Type of Change	Details
Media Control Platform (continued)	Enhancements to application modules (continued)	<ul style="list-style-type: none"> <li>• The NGI now supports only a relative path for the Full Call Recording feature. The path, specified by <code>&lt;local-directory-name&gt;</code> is treated as a path relative to the full call recording root path.</li> <li>• GVPi has been enhanced to support: <ul style="list-style-type: none"> <li>• Sending and receiving SIP INFO messages—Messages are received asynchronously and are accessible by the VoiceXML applications by using the <code>session.genesys.sip</code> object.</li> <li>• ASR session release—Includes explicit and implicit freeing of Media Resource Control Protocol (MRCP) resources if they are not in use.</li> <li>• The legacy 7.x <code>GarbageCollector</code> Dynamic Link Library (DLL)—Cleans up call-generated files in the <code>temp</code>, <code>logs</code> and <code>IIS log</code> folders. A Scheduler monitoring thread provides well-defined clean-up tasks at preconfigured intervals.</li> <li>• External DTMF grammars—For <code>&lt;grammar&gt;</code> elements that refer to external grammar files. (The GVPi is available only for Windows.)</li> </ul> </li> </ul> <p>For information about migrating legacy applications to use the GVPi, see the <i>Genesys Voice Platform 8.1 Application Migration Guide</i>.</p>
Supplementary Service Gateway	New component	<p>The new Supplementary Services Gateway component manages the initiation of outbound calls by allowing applications to make service requests to the Media Control Platform through the Resource Manager. It accepts batch requests for outbound session creation, and executes those requests depending on application-specific limits. The Supplementary Services Gateway also sends result notifications for success or failure of requests (including batched requests).</p>



**Table 179: Component Changes from GVP 8.1 to GVP 8.1.1 (Continued)**

Current Component Name	Type of Change	Details
Resource Manager	New features	Resource Manager supports the new outbound calling feature in the following ways: <ul style="list-style-type: none"> <li>• The Resource Manager now acts as a <i>notifier</i>, accepting SIP SUBSCRIBE requests from SIP Server. The Resource Manager can maintain multiple independent subscriptions from the same or different SIP devices.</li> <li>• The Resource Manager now manages call information policies for outbound calls.</li> </ul>
		<ul style="list-style-type: none"> <li>• The Resource Manager accepts campaign, tenant, and IVR Profile information from SIP Server for outbound requests.</li> <li>• A new <code>msml</code> service type has been added to support media dialog through the Media Server module of the Media Control Platform.</li> </ul>
	Functionality enhanced or modified	The policy management feature has been enhanced—The Resource Manager provides a list of disabled transcoders and a list of disabled codecs and passes them on to the Media Server module of the Media Control Platform.
Reporting Server	New reporting feature	The report manifest now contains the Reporting Server time zone information. The time zone and daylight-saving-time information are included in the manifest separately.
	New and enhanced reporting metrics	<ul style="list-style-type: none"> <li>• Enhanced reporting now includes:               <ul style="list-style-type: none"> <li>• 30-minute summaries that are maintained for one week by default.</li> <li>• An aggregate of the number of calls for Operational Reporting and VAR summaries.</li> <li>• Aggregate call peaks for the number of failed calls, and the percentage of successful calls.</li> </ul> </li> <li>• Additional data gathered from the Supplementary Services Gateways:               <ul style="list-style-type: none"> <li>• Reporting metrics include, current queue length, number of failed calls, and percentage of successful calls from the Supplementary Services Gateways.</li> </ul> </li> </ul>

**Table 179: Component Changes from GVP 8.1 to GVP 8.1.1 (Continued)**

Current Component Name	Type of Change	Details
Genesys Administrator (GVP-specific functions on the Provisioning tab)	Functionality enhanced or modified	<ul style="list-style-type: none"> <li>The IVR Profile Wizard has a new page on which you can configure IVR profiles to accept or reject outbound calls or transfers and configure dialing rules for them. Up to 100 rules can be added and recorded for outbound calls.</li> <li>The Resource Group Wizard Resource Assignment page now enables you to configure both SIP and SIPS ports, and to use a drop-down list to configure Redundancy as either Active or Passive.</li> </ul>
	Enhanced usability feature	The IVR Profile Wizard usability feature has a new button at the end of each URL input field that enables you to view the URL that has been entered and opens it in a web browser.
Genesys Administrator (GVP-specific functions on the Monitoring tab)	New features	The IVR Profile Utilization reports in the Dashboard now include columns for VAR and Supplementary Services Gateway data.
	Functionality enhanced or modified	Enhanced reporting now includes 30-minute summaries that are maintained for one week by default.
Genesys Administrator (GVP-specific functions on the Monitoring tab) (continued)		<ul style="list-style-type: none"> <li>The Real-time Reports Active Call List now has additional filters and relative time data is available for active calls.</li> <li>The VAR call browser is now merged with the Historical call browser.</li> </ul>

## 8.1.1 Configuration Option Changes

The following tables describe the changes to the configuration options, or parameters, for specific components of GVP 8.1.1

- Resource Manager and IVR Profiles—Table 180 on [page 1079](#)
- Media Control Platform—Table 181 on [page 1081](#)
- Call Control Platform—Table 182 on [page 1083](#)
- Reporting Server—Table 183 on [page 1084](#)

[Table 180](#) describes Resource Manager and IVR Profile changes

**Table 180: Resource Manager Configuration Changes in GVP 8.1.1**

Option/Section Name	Type of Change	Details
subscription section	New section added	<p>Parameters that enable Resource Manager to act as a <i>notifier</i>. Resource Manager accepts SUBSCRIPTION requests from SIP Server and, based on the event package, periodically sends NOTIFY messages to SIP Server.</p> <ul style="list-style-type: none"> <li>• sip.localhostname</li> <li>• subscription-duration</li> <li>• notify-interval</li> <li>• sip.localport</li> <li>• sip.localsecureport</li> <li>• sip.localuser</li> <li>• sip.transport.&lt;n&gt;, where &lt;n&gt; is an integer (1, 2, or 3)</li> </ul>
rm section	New options added	<p>default-resource-port-capacity—Indicates the default port capacity for the physical resources managed by the Resource Manager. The default value, 500, is used when the physical resources port capacity is not defined.</p>
<Resource Group> section	New option added	<p>redundancy-type—Specifies the type of redundancy (active or passive) when physical resources are added to Resource Groups (by using the Resource Groups Wizard in Genesys Administrator). When the Resource Manager routes requests, it can now determine if the resource is active or passive based on the configuration.</p> <p>This enhanced functionality is available when the Resource Manager is installed on Windows or Linux.</p>

**Table 180: Resource Manager Configuration Changes in GVP 8.1.1 (Continued)**

Option/Section Name	Type of Change	Details
<b>IVR Profile</b>		
gvp.policy section	New options added	<ul style="list-style-type: none"> <li>• disable-video</li> <li>• disable-g729</li> <li>• disable-amr</li> <li>• disable-amrwb</li> <li>• Parameter for MSML service when invoked in the context of an application: <ul style="list-style-type: none"> <li>♦ msml-capability-requirement</li> </ul> </li> <li>• Parameters for burst policies that are equivalent to other usage limit parameters: <ul style="list-style-type: none"> <li>♦ msml-level2-bust-limit</li> <li>♦ msml-level3-bust-limit</li> </ul> </li> <li>• Parameter to limit the number of sub-dialogs in a voiceXML call <ul style="list-style-type: none"> <li>♦ max-subdialog-depth</li> </ul> </li> <li>• Parameters for MSML service that are equivalent to the management policy parameters for the other service types: <ul style="list-style-type: none"> <li>♦ msml-allowed</li> <li>♦ msml-forbidden-respcode</li> <li>♦ msml-usage-limit</li> <li>♦ msml-usage-limit-per-session</li> <li>♦ msml-usage-limit-exceeded-respcode</li> <li>♦ msml-forbidden-set-alarm</li> <li>♦ msml-usage-limit-exceeded-set-alarm</li> </ul> </li> </ul>
gvp.policy.speech-resource section	New options added	<ul style="list-style-type: none"> <li>• Parameters to configure default ASR and TTS engines and the default language for ASR/TTS engines: <ul style="list-style-type: none"> <li>♦ asr.defaultengine</li> <li>♦ tts.defaultengine</li> <li>♦ defaultlanguage</li> </ul> </li> </ul>
gvp.service-parameter section	New options added	<ul style="list-style-type: none"> <li>• voicexml.gvpi.\$transferscript-url\$</li> <li>• voicexml.gvpi.\$tntenable\$:</li> <li>• voicexml.gvpi.\$tntscript\$</li> <li>• voicexml.gvpi.\$tntreclaimcode\$</li> <li>• voicexml.gvpi.\$refertimeout\$</li> </ul>

Table 181 describes Media Control Platform changes.

**Table 181: Media Control Platform Configuration Changes in GVP 8.1.1**

Option/Section Name	Type of Change	Details
asr section	New option added	The single parameter, <code>defaultengine</code> , is used to configure an ASR engine as the default engine.
ems section	Options removed	<ul style="list-style-type: none"> <li>• <code>dc.log_sinks</code></li> <li>• <code>dc.log_dll.MFSINK</code></li> <li>• <code>dc.logconfig.MFSINK</code></li> <li>• <code>dc.logconfig.TRAPSINK</code></li> <li>• <code>dc.log_queue_limit</code></li> <li>• <code>dc.log_write_buffer_size</code></li> <li>• <code>dc.metricsconfig.MFSINK</code></li> </ul>
mpc section	New options added	<ul style="list-style-type: none"> <li>• <code>rtp.h264deframingbuffersize</code></li> <li>• <code>rtp.h264allowrfc3984stapa</code></li> <li>• <code>rtp.recvaudiobuffersize</code></li> <li>• <code>rtp.recvvideobuffersize</code></li> <li>• <code>rtp.sendmode</code></li> <li>• <code>widebandconferences</code></li> <li>• <code>amrwb.preferred_mode</code></li> <li>• <code>amrwb.fmtp</code></li> <li>• <code>amrwb.enable_dtx</code></li> <li>• <code>amrwbpayload</code></li> <li>• <code>disabledcodecs</code></li> <li>• <code>disabledtranscoders</code></li> <li>• <code>cpa</code>—Many new options added to support call progress analysis. In the Media Server module of the Media Control Platform, CPA detects tones, human voice, and answering machine beeps. For a complete list of options for this new feature, see the <i>Genesys Voice Platform 8.1 User's Guide</i>.</li> </ul>
	Default value changed	<ul style="list-style-type: none"> <li>• <code>codec</code>—New default value: <code>pcmu pcma g726 gsm h263 h263-1998 h264 telephone-event</code></li> <li>• <code>mediadispatch_bucketamount</code>—New default value: 250</li> <li>• <code>mediadispatch_bucketwidth</code>—New default value: 4</li> </ul>

**Table 181: Media Control Platform Configuration Changes in GVP 8.1.1 (Continued)**

Option/Section Name	Type of Change	Details
msml section	New section added	<p>Parameters in this section support the Media Server Markup Language (MSML) application module on the Media Control Platform and enable it to act as an MSML Server</p> <ul style="list-style-type: none"> <li>• beep.filename</li> <li>• beep.join.timelimit</li> <li>• cpd.beep.timeout</li> <li>• cpd.postconnect.timeout</li> <li>• cpd.preconnect.timeout</li> <li>• cpd.record.basepath</li> <li>• cpd.record.fileext</li> <li>• info.contenttypes</li> <li>• play.basepath</li> </ul>
Netann section	New options added	<ul style="list-style-type: none"> <li>• annc.file.codecs</li> <li>• annc.http.codecs</li> </ul>
	Default value changed	record.basepath—New default value: \$InstallationRoot\$/record
sessmgr section	New option added.	MSML.MSML—New parameter to support MSML sessions.
	Default value changed	<ul style="list-style-type: none"> <li>• appmodules_linux—New default value: Remdial:RemoteDial Netann:Netann VXML3:VXML-NG</li> <li>• appmodules_win—New default value: Remdial:RemoteDial Netann:Netann VXML3:VXML-NG LegacyGVP:VXML-LGVP</li> <li>• modules_linux—New default value: Remdial Netann VXML3 MSML</li> <li>• modules_win—New default value: Remdial Netann VXML3 LegacyGVP MSML</li> </ul>
sip section	New options added	<ul style="list-style-type: none"> <li>• sdpaninprov</li> <li>• timer.prov.retransmit</li> <li>• passertedidentity</li> <li>• pcalledpartyid</li> </ul>

**Table 181: Media Control Platform Configuration Changes in GVP 8.1.1 (Continued)**

Option/Section Name	Type of Change	Details
vrm section	New options added	<ul style="list-style-type: none"> <li>• <code>client.mrcpv1.sendtrapformrcp*</code> and <code>client.mrcpv2.sendtrapformrcp*</code> <ul style="list-style-type: none"> <li>♦ <code>recogcompletioncause</code></li> <li>♦ <code>speakcompletioncause</code></li> <li>♦ <code>responsecode</code></li> <li>♦ <code>requestfailure</code></li> <li>♦ <code>responsefailure</code></li> </ul> </li> <li>• <code>client.mrcpv1.sendtrapfortsp*</code> and <code>client.mrcpv2.sendtrapforsip*</code> <ul style="list-style-type: none"> <li>♦ <code>responsecode</code></li> </ul> </li> </ul>
vxmli section	New options added	<ul style="list-style-type: none"> <li>• <code>max_size.vxml_page</code></li> <li>• <code>max_size.script_file</code></li> <li>• <code>max_size.xml_data</code></li> <li>• <code>max_subdialog_depth</code></li> <li>• <code>savetmpfiles.max_bytes</code></li> </ul>
	Option removed	<code>asr.defaultengine</code> —Option removed and replaced by a new option. See the <a href="#">asr</a> section in this table.
	Default value changed	<code>http.user_agent</code> —New default value: <code>GVPi/\$VERSION\$</code>

[Table 182](#) describes Call Control Platform changes.

**Table 182: Call Control Platform Configuration Changes in GVP 8.1.1**

Option/Section Name	Type of Change	Details
ems section	Options removed	<ul style="list-style-type: none"> <li>• <code>dc.log_sinks</code></li> <li>• <code>dc.log_dll.MFSINK</code></li> <li>• <code>dc.logconfig.MFSINK</code></li> <li>• <code>dc.log_queue_limit</code></li> <li>• <code>dc.log_write_buffer_size</code></li> </ul>

[Table 183](#) describes Reporting Server changes.

**Table 183: Reporting Server Configuration Changes in GVP 8.1.1**

Option/Section Name	Type of Change	Details
dbmp section	New options added	<ul style="list-style-type: none"> <li>rs.db.retention.var.30min.default</li> <li>rs.db.retention.operations.30min.default</li> </ul>
reporting section	New options added	<ul style="list-style-type: none"> <li>rs.query.limit.30min</li> </ul>

## 8.1.1 Reporting Server Database Changes

The Reporting Server database schema version is always the same as the release number of the Reporting Server installation package (IP).

[Table 184](#) summarizes the major changes to the Reporting Server database schema from GVP 8.1 to GVP 8.1.1.

**Table 184: Reporting Server Database Schema Changes from GVP 8.1 to GVP 8.1.1**

Type of Change	Details
New tables	<ul style="list-style-type: none"> <li>CCP_ARRIVALS_30MINS</li> <li>CCP_ARRIVALS_5MINS</li> <li>CCP_ARRIVALS_DAY</li> <li>CCP_ARRIVALS_HOUR</li> <li>CCP_ARRIVALS_MONTH</li> <li>CCP_ARRIVALS_WEEK</li> </ul>
	<ul style="list-style-type: none"> <li>CCP_PEAKS_30MINS</li> <li>CCP_PEAKS_5MINS</li> <li>CCP_PEAKS_DAY</li> <li>CCP_PEAKS_HOUR</li> <li>CCP_PEAKS_MONTH</li> <li>CCP_PEAKS_WEEK</li> </ul>
	<ul style="list-style-type: none"> <li>MCP_ARRIVALS_30MINS</li> <li>MCP_ARRIVALS_5MINS</li> <li>MCP_ARRIVALS_DAY</li> <li>MCP_ARRIVALS_HOUR</li> <li>MCP_ARRIVALS_MONTH</li> <li>MCP_ARRIVALS_WEEK</li> </ul>



**Table 184: Reporting Server Database Schema Changes from GVP 8.1 to GVP 8.1.1 (Continued)**

Type of Change	Details
New tables (continued)	<ul style="list-style-type: none"> <li>• MCP_PEAKE_30MINS</li> <li>• MCP_PEAKE_5MINS</li> <li>• MCP_PEAKE_DAY</li> <li>• MCP_PEAKE_HOUR</li> <li>• MCP_PEAKE_MONTH</li> <li>• MCP_PEAKE_WEEK</li> </ul>
	<ul style="list-style-type: none"> <li>• PERIOD_IVR_ACTION_STATS_30MINS</li> <li>• PERIOD_IVR_ACTION_STATS_5MINS</li> <li>• PERIOD_IVR_ACTION_STATS_DAY</li> <li>• PERIOD_IVR_ACTION_STATS_HOUR</li> <li>• PERIOD_IVR_ACTION_STATS_MONTH</li> <li>• PERIOD_IVR_ACTION_STATS_WEEK</li> </ul>
	<ul style="list-style-type: none"> <li>• PERIOD_RESULT_STATS_30MINS</li> <li>• PERIOD_RESULT_STATS_5MINS</li> <li>• PERIOD_RESULT_STATS_DAY</li> <li>• PERIOD_RESULT_STATS_HOUR</li> <li>• PERIOD_RESULT_STATS_MONTH</li> <li>• PERIOD_RESULT_STATS_WEEK</li> </ul>
	<ul style="list-style-type: none"> <li>• RM_ARRIVALS_30MINS</li> <li>• RM_ARRIVALS_5MINS</li> <li>• RM_ARRIVALS_DAY</li> <li>• RM_ARRIVALS_HOUR</li> <li>• RM_ARRIVALS_MONTH</li> <li>• RM_ARRIVALS_WEEK</li> </ul>
	<ul style="list-style-type: none"> <li>• RM_PEAKE_30MINS</li> <li>• RM_PEAKE_5MINS</li> <li>• RM_PEAKE_DAY</li> <li>• RM_PEAKE_HOUR</li> <li>• RM_PEAKE_MONTH</li> <li>• RM_PEAKE_WEEK</li> </ul>

**Table 184: Reporting Server Database Schema Changes from GVP 8.1 to GVP 8.1.1 (Continued)**

Type of Change	Details
Tables modified	The CCP_CDR, MCP_CDR, and RM_CDR tables each have three new columns: <ul style="list-style-type: none"> <li>• GVP_GUID_HASH</li> <li>• GENESYS_UUID_HASH</li> <li>• CSID</li> </ul>
	The EVENT_LOGS and VAR_CDRS tables each have a new CSID column.
	The TIMECOMPONENTS table has a new HALF_HOUR_COL column.
	The LASTSUMMARIZED table has a new LASTSUMMARIZEDID column.
	The CUSTOM_VARS table has a new VARS column and the following three columns have been removed: <ul style="list-style-type: none"> <li>• VAR_ID</li> <li>• NAME</li> <li>• VALUE</li> </ul>

For information about upgrading the Reporting Server database, see “Migrating the Microsoft SQL Server Database” on [page 1095](#) or “Migrating the Oracle Database” on [page 1096](#).



## Chapter

# 63

## Migration Procedures for GVP 8.x

This chapter provides the migration procedures for Genesys Voice Platform (GVP) 8.x. Refer to other sections of this book for detailed information about migrating Framework and other Genesys solutions.

This chapter contains the following sections:

- [Migration of GVP 8.0 and 8.1, page 1087](#)
- [Rollback Procedures, page 1096](#)
- [High Availability Migration, page 1099](#)

---

### Migration of GVP 8.0 and 8.1

This section describes the following procedures:

- [Procedures to Migrate GVP 8.0 on page 1088](#)
- [Procedures to Migrate GVP 8.1 on page 1092](#)
- [Migrating the Reporting Server Databases on page 1094](#)

As described in “Order of Migration” on [page 1054](#), complete the following preliminary procedures before starting the migration of GVP:

1. Migrate Management Framework, as applicable for your deployment. In particular, you must migrate to Genesys Administrator release 8.0.1 for GVP 8.1, or release 8.0.11 for GVP 8.1.1.

If you plan to upgrade Configuration Server, Genesys recommends that you first back up the Configuration Layer to an XML file. To do this:

- a. Open the command console by selecting Start > Run, and then entering cmd.
- b. Navigate to the Configuration Server directory—for example:  
`cd C:\Program Files\GCTI\Multitenant Configuration Server`

- c. Execute the following command to export the configuration:

```
confserv.exe -export <file name.xml>
```

---

**Note:** If you are required to rollback to the original configuration after attempting the migration, you can use the `confserv.exe -import <file name.xml>` command to import `<file name.xml>` back into the Configuration Server directory.

IVR Profile configurations are captured in the exported XML file. The `<file name.xml>` file is created in the same folder as the `confserv.exe` file. This is a useful backup, although it is not necessary to modify the IVR Profiles in any way to migrate from GVP 8.0 to GVP 8.1 or from GVP 8.1 to GVP 8.1.1.

---

2. Upgrade other prerequisite Genesys components (for example, SIP Server, IVR Server, or Interaction Server), as applicable for your deployment. See “Compatibility Among Components” on [page 1057](#) for the compatible version of the prerequisite components for GVP 8.1 and GVP 8.1.1.
3. Update the contact center configuration if required (for example, Place Groups, Agent Groups, and DNSs).

## Procedures to Migrate GVP 8.0

Complete the following procedures to migrate from GVP 8.0 to GVP 8.1 and VPS 8.1:

### Upgrade GVP

#### Back Up the Configuration

1. Back up the configurations of the GVP 8.0 component `Application` objects.

---

**Note:** You may already have backed up the whole Configuration Layer as part of the Management Framework migration (see [Step 1](#) on [page 1087](#)). However, Genesys recommends that you also back up the GVP components individually, to help you reinstate customized configuration options later (see [Step 8](#) on [page 1090](#)).

---

For each GVP `Application` object in your GVP 8.0 deployment:

- a. In Genesys Administrator, go to the `Provisioning > Environment > Applications > <GVP Application> > Options` tab.
- b. On the toolbar, click `Export`.
- c. In the dialog box, select the export format. The options are to export as a `.cfg` file or as an `.xml` file.
- d. In the `File Download` dialog box, click `Save`, and then save the configuration file to a convenient location.

2. To ensure that you retain the built-in audio files that your deployment uses for DTMF tones and for prompts, back up the files in the <MCP installation path>/audio directory and subdirectories.

### Stop GVP Processes

3. Stop GVP:
  - a. In Genesys Administrator, go to Provisioning > Environment > Applications > and select each application.
  - b. In the Tasks panel, select Stop application gracefully.
  - c. In the confirmation dialog box, click OK.  
All Application processes in the GVP solution are shut down gracefully. *Graceful shutdown* means that no new calls will be accepted, and the system will wait as long as necessary for the last call to finish before it shuts down the processes.
  - d. Wait until the status displayed in Genesys Administrator shows that the Applications have been stopped.

For more information about stopping GVP processes, see the *Genesys Voice Platform 8.1 Deployment Guide* or the online *Framework 8.0 Genesys Administrator Help*.

### Uninstall GVP 8.0

4. Uninstall the GVP 8.0 components. On each GVP host:
  - a. Select Start > Control Panel > Add or Remove Programs.
  - b. Select the component application, and then click Change/Remove.
  - c. In the confirmation message box, click OK.

The component application is uninstalled, but it is not deleted from the Configuration Database; therefore, it still appears in the Applications list in Genesys Administrator.

---

**Note:** In general, Genesys recommends that you uninstall components in reverse order of dependency or reverse order of installation, although this is not strictly required for GVP.

---

### Create and Install 8.1 Applications

5. In Genesys Administrator, create and install the Applications for the following GVP 8.1 configuration objects:
  - Fetching Module (for the Media Control Platform and Call Control Platform, respectively)
  - Resource Manager
  - Media Control Platform
  - Call Control Platform (if it is present in your deployment)
  - Reporting Server
  - CTI Connector (if you are adding it to your Windows deployment)
  - MRCPv1 or MRCPv2 ASR and TTS servers (if they are present in your deployment)

There are three ways to create and install the Applications:

- Use the Installation Packages Import Wizard to import all the GVP installation packages (IPs) to the Genesys Administrator Repository, and then use the Installation Wizard to install the IPs. You can install the Applications with default settings, and then go back later to reinstate customized configuration options.
- For each component, create a new, 8.1 Application Template and import the metadata, and then make a copy of the existing 8.0 Application and apply the 8.1 Application Template to the new copy. Modify the server connections in the Connections section of the Configuration tab, and modify the values of configuration options on the Options tab, if required. Then, use the Installation Wizard to install the IP on the GVP host.
- Use the Create Application Wizard to create the new Applications individually, and import the 8.1 Application Templates and their metadata at the same time. Modify the server connections in the Connections section of the Configuration tab, and modify the values of configuration options on the Options tab, if required. Then, use the Installation Wizard to install the IP on the GVP host.

For more information about the methods for creating and installing GVP Applications, see the *Genesys Voice Platform 8.1 Deployment Guide*. For the new configuration options that were introduced in GVP 8.1, see “8.1 Configuration Option Changes” on [page 1065](#).

6. Using the Resource Group Wizard in Genesys Administrator, create the resource groups to provision the GVP resources for the GVP 8.1 Resource Manager. For more information about creating the resource groups, see the *Genesys Voice Platform 8.1 Deployment Guide*.
  7. Load the GVP 8.1 Management Information Bases (MIBs) into your Simple Network Management Protocol (SNMP) management console.
- Verify the Configuration**
8. Verify that the GVP 8.1 configuration accords with the old, GVP 8.0 configuration:
    - a. For each component application, export the new configuration file as described in [Step 1 on page 1088](#).
    - b. In the command console, execute the following command to compare the new configuration file with the old one:
 

```
fc <old cfg file> <new cfg file>
```
    - c. Based on the result, modify the configuration as required, on the Options tab of the applicable Application objects.
  9. If you installed the Media Control Platform release 8.1 in a different directory from the 8.0 Media Control Platform, update the grammar base path in Microsoft Internet Information Server (IIS):
    - a. On the Media Control Platform host, go to Start > Administrative Tools > Internet Information Services (IIS) Manager > <Host> > Web Sites > Default Web Site.

- b. Right-click `vggrammarbase`, and then select `Properties`.
  - c. On the `Virtual Directory` tab, update `Local path`.
  - d. Click `OK`.
10. Review the audio files in the `<MCP installation path>/audio` subdirectories. If your deployment uses other audio files that were in the `audio` subdirectories in the 8.0 installation, manually copy the files from the backup location (see [Step 2 on page 1089](#)) into the new `audio` directory. For information about changes to the `audio` directory since release 8.0, see [page 1061](#).

### Upgrade the Reporting Server Database

11. Migrate the Reporting Server database. See “Migrating the Reporting Server Databases” on [page 1094](#).

### Start GVP 8.1

12. If you did not clear the cookie cache of your browser after you upgraded to Genesys Administrator 8.0.1 (see [Step 1 on page 1087](#)), delete cookies now. Otherwise, GVP reports may not work.
13. Start the GVP 8.1 components. You can start the components in any order, except for the following requirements:
  - Start the RDBMS server for the Reporting Server database before you start the Reporting Server.
  - Start the Fetching Module (and Squid) before you start the Media Control Platform and, if applicable, the Call Control Platform.

For more information about starting and stopping GVP, see the *Genesys Voice Platform 8.1 Deployment Guide*.

14. Verify proper operation of GVP 8.1 by checking the logs for errors. Because a GVP migration is effectively a new installation, the kinds of problems you may encounter are similar to the usual setup and startup problems for new installations. The most likely areas to check are successful database upgrade and successful importation of the old configuration. For more information about the errors you may encounter, see the *Genesys Voice Platform 8.1 Troubleshooting Guide*.  
If the upgrade of any component fails, recreate and reinstall it, or roll back to GVP 8.0. For more information, see “Rollback Procedures” on [page 1096](#).

## Procedures to Migrate GVP 8.1

Complete the following procedures to migrate from GVP 8.1 to GVP 8.1.1 and VPS 8.1.1:

---

**Note:** Linux is supported in GVP 8.1, therefore you can use these procedures to migrate GVP on Linux or Windows.

---

### Upgrade GVP

#### Back Up the Configuration

1. Back up the configurations of the GVP 8.1 component `Application` objects.

---

**Note:** You may already have backed up the whole Configuration Layer as part of the Management Framework migration (see [Step 1 on page 1087](#)). However, Genesys recommends that you also back up the GVP components individually, to help you reinstate customized configuration options later (see [Step 8 on page 1090](#)).

---

For each GVP `Application` object in your GVP 8.1 deployment, follow [Steps 1 and 2](#) in “Procedures to Migrate GVP 8.0” on [page 1088](#).

#### Stop GVP Processes

2. Stop GVP: See the sub-steps in [Step 3 on Page 1089](#).

#### Uninstall GVP 8.1

3. Uninstall the GVP 8.1 components in Genesys Administrator:
  - a. On the `Provisioning` tab, select `Environment > Applications`.
  - b. Double-click the component application you want to uninstall.
  - c. When the `Configuration` tab appears, select `Uninstall` in the toolbar.
  - d. When the `Confirm` dialog box appears, click `Yes`.

The component application is uninstalled, but it is not deleted from the Configuration Database; therefore, it still appears in the `Applications` list in Genesys Administrator.

---

**Note:** In general, Genesys recommends that you uninstall components in reverse order of dependency or reverse order of installation, although this is not strictly required for GVP.

---

#### Create and Install 8.1.1 Applications

4. In Genesys Administrator, create and install the `Applications` for the following GVP 8.1.1 configuration objects:
  - Fetching Module (for the Media Control Platform and Call Control Platform, respectively)
  - Resource Manager
  - Media Control Platform
  - Call Control Platform (if it is present in your deployment)



- Reporting Server
- Supplementary Services Gateway
- CTI Connector (if you are adding it to your Windows deployment)
- MRCPv1 or MRCPv2 ASR and TTS servers (if they are present in your deployment)

See [Step 5 on Page 1089](#) for the various ways to create and install Applications.

---

**Note:** In release 8.1.1, GVP components are installed as Windows Services and can be configured to start automatically.

---

### Verify the Configuration

5. Using the Resource Group Wizard in Genesys Administrator, create the resource groups to provision the GVP resources for the GVP 8.1.1 Resource Manager. For more information about creating the resource groups, see the *Genesys Voice Platform 8.1 Deployment Guide*.
6. Load the GVP 8.1.1 Management Information Bases (MIBs) into your Simple Network Management Protocol (SNMP) management console.
7. Verify that the GVP 8.1.1 configuration replicates the old, GVP 8.1 configuration:
  - a. For each component application, export the new configuration file as described in [Step 1 on page 1088](#).
  - b. In the command console, execute the following command to compare the new configuration file to the old one:
    - On Windows, enter `fc <old cfg file> <new cfg file>`
    - On Linux, enter `diff <old cfg file> <new cfg file>`
  - c. Based on the result, modify the configuration as required, on the Options tab of the applicable Application objects.
8. If you installed the Media Control Platform release 8.1.1 in a different directory from the 8.1 Media Control Platform:
  - On Windows, update the grammar base path in Microsoft Internet Information Server (IIS). See the sub-steps in [Step 9 on Page 1090](#).
  - On Linux, create a softlink to the target directory. On the Apache Web Server, in the Web home directory enter the following command:
 

```
ln -s <Install_Dir>/gvp/"ProductName"_8.1/grammar /var/www/vggrammarbase
```
9. Review the audio files in the <MCP installation path>/audio subdirectories.

---

**Note:** If your deployment uses other audio files that were in the `audio` subdirectories in the 8.1 installation, manually copy the files from the backup location (see [Step 2 on page 1089](#)) into the new `audio` directory. For information about changes to the Media Control Platform since release 8.1, see Table 179 on [page 1075](#).

---

### Upgrade the Reporting Server Database

10. Migrate the Reporting Server database. See “[Migrating the Reporting Server Databases](#)”.

#### Start GVP 8.1.1

11. If you did not clear the cookie cache of your browser after you upgraded to Genesys Administrator 8.0.11 (see [Step 1 on page 1087](#)), delete cookies now. Otherwise, GVP reports may not work.
12. Start the GVP 8.1.1 components. You can start the components in any order, except for the following requirements:
  - Start the RDBMS server for the Reporting Server database before you start the Reporting Server.
  - Start the Fetching Module (and Squid) before you start the Media Control Platform and, if applicable, the Call Control Platform.

For more information about starting and stopping GVP, see the *Genesys Voice Platform 8.1 Deployment Guide*.

13. Verify proper operation of GVP 8.1.1 by checking the logs for errors.

Because a GVP migration is effectively a new installation, the kinds of problems you may encounter are similar to the usual setup and startup problems for new installations. The most likely areas to check are successful database upgrade and successful importation of the old configuration. For more information about the errors you may encounter, see the *Genesys Voice Platform 8.1 Troubleshooting Guide*.

If the upgrade of any component fails, recreate and reinstall it, or roll back to GVP 8.1. For more information, see “[Rollback Procedures](#)” on [page 1096](#).

## Migrating the Reporting Server Databases

This section contains procedures to migrate your Microsoft SQL or Oracle Reporting Server database by updating the schema version 8.0.000 to version 8.1.000 or schema version 8.1.000 to version 8.1.100.

## Migrating the Microsoft SQL Server Database

Complete the following steps to upgrade your Microsoft SQL Server database:

### Back Up the Database

1. Verify that the Reporting Server process is stopped, and that nothing is connected to the database.  
Genesys recommends that you check that there are no established connections to the Microsoft SQL Server default port number 1433. Use the following command:  
`netstat -na | grep "1433"`
2. Use Microsoft SQL Server Management Studio to connect to the Microsoft SQL Server, and log in using SA or the Windows Authentication account.
3. Back up the Reporting Server database:
  - a. Check the size of the Reporting Server database, to ensure that you provide a backup destination with sufficient disk space. To view the size, right-click the database in the Microsoft SQL Server Management Studio window, and then select **Properties**.
  - b. Right-click the database you want to back up, and then select **Tasks > Back Up**.  
The **Back Up Database** dialog box appears.
  - c. In the **Destination** section, select the radio button to back up to disk.
  - d. In the **Back up to** text box, enter the path to a disk with sufficient space for the database (see [Step 3a](#)).
  - e. Click **OK**.
  - f. When the backup completes successfully, a confirmation dialog box displays. Click **OK**.

### Upgrade the Database

4. Upgrade the Reporting Server database:
  - a. In the Microsoft SQL Server Management Studio, select **File > Open**.
  - b. In the **Open File** dialog box, navigate to the `[InstallationRoot]/scripts/` directory, and then select the script for either 8.1 or 8.1.1 migration:
    - `mssql-schema-upgrade-800-810.sql`
    - `mssql-schema-upgrade-810-811.sql`
  - c. Click **Open**.  
You are returned to the Microsoft SQL Server Management Studio window.
  - d. In the drop-down list on the toolbar, select the database that you want to upgrade (the Reporting Server 8.0 or 8.1 database).
  - e. Click **Execute**.
  - f. After the script has run, verify that the **Messages** pane does not show any error messages.

Migration of the Reporting Server database is complete.

## Migrating the Oracle Database

Complete the following steps to upgrade your Oracle database from Reporting Server database schema version 8.0.000 to version 8.1.000 or from schema version 8.1.000 to version 8.1.100:

### Back Up the Database

1. Verify that the Reporting Server process is stopped, and that nothing is connected to the database.

Genesys recommends that you check that there are no established connections to the Oracle default port number 1521. Use the following command:

```
netstat -na | grep "1521"
```

2. Back up the Reporting Server database.

---

**Note:** Genesys recommends that an Oracle database administrator (DBA) perform the database backup.

---

### Upgrade the Database

3. Use any SQL client software (for example, Oracle SQL Developer) to upgrade the Reporting Server database:
  - a. In the SQL client, create a connection to the Reporting Server database.
  - b. Open the script in the Reporting Server installation directory at [InstallationRoot]/scripts/ for either the 8.1 or 8.1.1 migration:
 

```
oracle-schema-upgrade-800-810.sql
```

```
oracle-schema-upgrade-810-811.sql
```
  - c. In the script window, select the connection to the Reporting Server database.
  - d. Run the script.
  - e. After the script has run, verify that the Script Output pane does not show any error messages.

Migration of the Reporting Server database is complete.

---

## Rollback Procedures

If the upgrade of any of the GVP components is unsuccessful, or if you want to roll back to the earlier GVP release, do the following:

1. Stop GVP, or verify that it is stopped.
2. Uninstall the GVP 8.1 (or 8.1.1) Applications, and then delete them from Genesys Administrator.
3. Reinstall the GVP 8.0 (or 8.1) Applications.

- If you not only uninstalled the GVP 8.0 (or 8.1) Applications but also deleted them in Genesys Administrator (in other words, they are no longer in the Configuration Database), you must recreate, configure, and install the GVP 8.0 (or 8.1) Application objects as described for new installations in the *Genesys Voice Platform 8.1 Deployment Guide*, except that you must use GVP 8.0 (or 8.1) Application Templates.
  - If you uninstalled the GVP 8.0 (or 8.1) Applications but have not yet deleted them in Genesys Administrator (in other words, they are still in the Configuration Database), run the Installation Wizard to install them, as described in the *Genesys Voice Platform 8.1 Deployment Guide*.
  - If the reason for the rollback relates to Genesys Administrator issues, roll back Genesys Administrator to release 8.0 (or 8.1), as described in the Management Framework part of this guide. Then reinstall the GVP 8.0 (or 8.1) Applications, as described in the *Genesys Voice Platform 8.0 (or 8.1) Deployment Guide*.
4. For each component, reinstate any custom configuration you may have lost in the rollback process.
  5. Roll back the Reporting Server database schema, and recover the GVP 8.0 (or 8.1) Reporting Server database. Genesys recommends that a qualified DBA perform the database recovery. See [“Rolling Back the Microsoft SQL Server Database”](#) and [“Rolling Back the Oracle Database”](#).
  6. Restart the GVP 8.0 (or 8.1) Applications. For startup requirements, see [Step 13 on page 1091](#).

---

**Note:** Consult Professional Services regarding migration of any and all customized Genesys products.

---

## Rolling Back the Microsoft SQL Server Database

Use this recovery procedure to roll back the Microsoft SQL Server.

1. Use Microsoft SQL Server Management Studio to connect to the Microsoft SQL Server, and log in using SA or the Windows Authentication account.
2. Remove the current Reporting Server database:
  - a. Ensure that the name of the database you backed up previously does not exist on the database server.
  - b. If you have used the same name for the database that you have just migrated (8.1 or 8.1.1), delete the database:
    - Right-click the database name and select **Delete**.
    - In the **Delete Object** dialog, check **Close existing connections** and click **OK**.

The **Databases** tree no longer shows the deleted database.

3. Restore the 8.0 or 8.1 Reporting Server database:
  - a. In the Management Studio Object Explorer window, right-click Databases, and select Restore database.
  - b. In the section, Specify the source and location of backup sets to restore, click the From device radio button.
  - c. At the end of the From device field, click the (...) browse button.
  - d. When the Specify Backup dialog appears, click Add.
  - e. When the File selection dialog appears, browse to the backup file.
  - f. Click OK twice to confirm and save the settings.
4. In the Restore database dialog, check Restore for the backup sets you selected in [Step 3](#) and click OK.
5. When the restore process is successfully completed and the confirmation dialog box appears, click OK.

## Rolling Back the Oracle Database

The procedure to rollback the Oracle database should be performed by a qualified database administrator (DBA). Visit the Oracle web site for more information about database recovery and rollback procedures. Genesys recommends you obtain the following reference material from the web site:

- *Oracle Database Backup and Recovery Basics*
- *Oracle Database Backup and Recovery Advanced User's Guide*

If you find this material to be too complex, use this procedure as a guideline to backup and restore the database schema.

---

**Warning!** The following steps are intended to present concepts and are not the actual commands to rollback the Oracle database. A qualified DBA should be familiar with the guidelines presented here and be able to determine how they relate to the actual commands to rollback your Oracle database to the original configuration.

---

1. Backup or export the schema by running the following command from a system console:
  - On Windows: C:\oracle\product\10.2.0\db\_1\BIN>exp  
userid=system/password file=rs\_810.dmp log=rs\_810\_exp.log  
owner=reporting
  - On Linux: \$ORACLE\_HOME/bin/exp userid=system/password  
file=rs\_810.dmp log=rs\_810\_exp.log owner=reporting
2. Using any SQL client, connect to the Oracle database as SYSDBA.
  - a. Delete the RS user named, reporting.
  - b. Using the same default tablespace, temp tablespace, role, and privileges, recreate the RS user by using the same name, reporting.

3. Restore the schema by running the following import command from a system console:
  - On Windows: `C:\oracle\product\10.2.0\db_1\BIN>imp  
userid=system/password file=rs_810.dmp log=rs_810_imp.log  
fromuser=reporting`
  - On Linux: `$ORACLE_HOME/bin/imp userid=system/password  
file=rs_810.dmp log=rs_810_imp.log`

The backup and restore should be completed without errors.

## High Availability Migration

High Availability (HA) for the Resource Manager on Windows is implemented differently in GVP 8.1 than it was in GVP 8.0. The Cluster Manager component has been embedded within the Resource Manager itself.

To migrate a Resource Manager Application object from GVP 8.0 to GVP 8.1 for HA, you must transfer parameters that were formerly configured in the Cluster Manager Application object to the `cluster` section in the Resource Manager configuration.

If you are migrating from GVP 8.1 to GVP 8.1.1, you do not need to transfer the parameters in [Table 185](#), because the implementation of High Availability (HA) for Windows has not changed from release 8.1 to 8.1.1.

[Table 185](#) lists the configuration options that you must set, along with their required values.

**Table 185: Migrating HA Configuration Options**

8.0 Configuration		8.1 Resource Manager Configuration	
Component	Section.Option	Section.Option	Value
Cluster Manager	<code>cluster.NLBScriptPath</code>	<code>cluster.FailOverScript</code>	<code>\$InstallationRoot\$/bin/NLB.bat</code>
Resource Manager	<code>rm.cluster_ip</code>	<code>cluster.virtual-ip</code>	<Virtual IP address for all RM hosts in the cluster>
	<code>rm.cluster_hotstandby</code>	<code>cluster.hotstandby</code>	TRUE
	<code>proxy.sip.transport.1</code> <b>Note:</b> You had to change the value of this parameter from its default value to the virtual IP address for the Resource Manager HA setup.	<code>proxy.sip.transport.1</code>	<code>transport 1 tcp:any:5060</code> (default) <b>Note:</b> You do not need to change the value of this parameter from its default value.







## Chapter

# 64 Migration Procedures for GVP 7.6

This chapter provides the migration procedures for Genesys Voice Platform (GVP) 7.6. Refer to other sections of this book for detailed information about migrating Framework and other Genesys solutions.

This chapter contains the following section:

- [Migration of GVP 7.6, page 1101](#)
- [Common Configuration Mappings, page 1107](#)

---

## Migration of GVP 7.6

Upgrading GVP 7.6 to GVP 8.1 is not strictly migration because you must install a new installation of GVP 8.1. In addition, there are fewer components in the new GVP 8.1 architecture and, although the functionality is almost equivalent (enhanced in GVP 8.1) to GVP 7.6, it is not necessarily provided by the same components. However, it is possible, with proper planning, to upgrade your GVP 7.6 deployment and, with a few exceptions, retain system functionality and continue to run your legacy voice and call control applications unchanged.

For information about migrating GVP 7.6 Voice Extensible Markup Language (VoiceXML) and Telera XML (TXML) applications, see the *Genesys Voice Platform 8.1 Application Migration Guide*. For more information about GVP 8.1 support for legacy interpreter features, see the *Genesys Voice Platform 8.1 Legacy Genesys VoiceXML 2.1 Reference Manual*.

The following main topics are discussed in this section:

- [Migration Strategy on page 1104](#)

- [Procedures to Migrate GVP 7.6 on page 1105](#)

**Note:** The procedures and mapping tables in this section apply to migrating GVP 7.6 to GVP 8.1 on Windows only.

Table 186 shows how GVP 7.6 modules and components map to GVP 8.1 and VPS 8.1 components.

**Table 186: GVP 7.6 to 8.1 Component Mapping**

7.6 Voice Platform Component or Module	8.1 Genesys Voice Platform Equivalent Functionality
IVR Server Client	CTI Connector (CTIC)
SIP Session Manager	Resource Manager and SIP Server (8.0.1)
Resource Manager	Resource Manager
Policy Manager	Resource Manager
Application Reporter	Reporting Server (Voice Platform Application Reporter is still used for legacy voice and call control applications.)
EventC	Reporting Server
IP Communication Server	Media Control Platform
Studio	Composer (Voice Platform Studio is still used for legacy voice and call control applications.)
Common	Common (not a separate Installation Package [IP])
MIBs	MIBs
Element Management Provisioning System (EMPS)	Configuration database, multi-tenant Configuration Server, Genesys Administrator
Installation Wizard	Genesys Administrator (8.0.11) Deployment Wizard
Text-to-Speech	Integrated into the Media Control Platform
Login Server	Integrated into the Genesys Administrator GUI.

**Table 186: GVP 7.6 to 8.1 Component Mapping (Continued)**

7.6 Voice Platform Component or Module	8.1 Genesys Voice Platform Equivalent Functionality
Reporter	Integrated into the Genesys Administrator GUI.
Call Status Monitor	Integrated into the Genesys Administrator GUI.
Network Monitor	Integrated into the Genesys Administrator GUI.
Portal	Integrated into the Genesys Administrator GUI.
Application Reporter Java SDK	Same 7.6 component is used.
Application Reporter Java Client	Same 7.6 component is used
Application Reporter COM Client	Same 7.6 component is used
Platform Dispenser	No equivalent (not required)
IP Communication Server, Developers Edition (DE)	No equivalent.
CTI Simulator, DE	No equivalent.
Outbound Notification (OBN) Manager	No equivalent in 8.1, however, this component maps directly to the Supplementary Services Gateway in GVP 8.1.1. See “Outbound Notification Mapping” on <a href="#">page 1120</a> .
Bulk Provisioning Tool	No equivalent.
H.323 Session Manager	No equivalent.
ASR Log Server	No equivalent.
ASR Log Manager	No equivalent.
ASR Log Agent	No equivalent.
Bandwidth Manager	No equivalent.
Cisco Queue Adapter	No equivalent.
Dialogic Installer	No equivalent.
Voice Communication Server	No equivalent.

### Additional Considerations

- Legacy VoiceXML applications can only be modified by using Genesys Studio 7.6 and application reporting for legacy applications can only be modified by using VAR 7.6. However, you can use these development tools even after migrating to GVP 8.1.
- To ensure that your legacy VoiceXML applications are supported in GVP 8.1, configure the Legacy GVPi in the Media Control Platform so that they can run unchanged. New VoiceXML applications created in Composer are supported by the NGI only..

---

**Note:** For information about migrating GVP 7.6 Voice Extensible Markup Language (VoiceXML) and Telera XML (TXML) applications, see the *Genesys Voice Platform 8.1 Application Migration Guide*. For more information about GVP 8.1 support for legacy interpreter features, see the *Genesys Voice Platform 8.1 Legacy Genesys VoiceXML 2.1 Reference Manual*.

---

- IVR Server 7.6 and SIP Server 7.6 are interoperable with GVP 7.6 and GVP 8.1, but you must have the latest version of SIP Server. (8.0.1 for GVP 8.1).
- Although the EventC and the real-time reporting functionality of the 7.6 VP Reporter component are similar in Reporting Server 8.1 and Genesys Administrator 8.0.11, GVP 8.1 does not support multi-tenancy and has a completely different architecture. Therefore, you cannot migrate configuration or customer data from GVP 7.6 to GVP 8.1. You must install a new instance of the Reporting Server and configure it to provide historical and real-time data as described in the *Genesys Voice Platform 8.1 Deployment Guide* and *Genesys Voice Platform 8.1 User's Guide*. See also, “Reporting Component Mapping” on [page 1120](#).
- GVP 7.6 and GVP 8.1 cannot operate in mixed mode. You cannot upgrade the GVP 7.6 deployment gradually by migrating one component at a time while the system is operational and processing calls.

## Migration Strategy

Genesys recommends the following strategy for GVP 7.6 migration:

1. Install or migrate Management Framework. See [Step 1](#) in “Order of Migration” on [page 1054](#)

Management Framework is the foundation for all Genesys products, solutions, and options and is a prerequisite in the 8.1 VPS.

2. Upgrade or install other prerequisite Genesys components (SIP Server, Composer), as required. See “Compatibility Among Components” on [page 1057](#).

---

**Note:** Ensure the version of SIP Server you are installing is 7.6.000.66 or later.

---

### Migrating to GVP 8.1

3. Migrate GVP:
  - Build an 8.1 environment and then retire the 7.6 servers or redeploy then in the upgraded platform, (for full details, see Chapter 64 on [page 1101](#)).
  - Back up the GVP 7.6 component configurations.
  - Stop GVP gracefully.
  - Uninstall the GVP 7.6 components.
  - Create and configure new, 8.1 GVP Application objects, and install the GVP Applications on their hosts.
  - Install the Reporting Server database.
  - Start GVP 8.1
4. When GVP 8.1 is operational, copy the configuration options manually from EMPS and other 7.6 components to the equivalent 8.1 components by using Genesys Administrator. (There is no data migration tool for GVP 8.1.) See “Component Configuration Mapping” on [page 1108](#).
5. When server migration is completed, migrate the IVR Profiles and Dialed Number (DN) mappings by using the information in the *Genesys Voice Platform 8.1 Application Migration Guide*. You can use the internal Perl script tool to convert the `AppId.xml` options to the equivalent IVR Profile configuration options in Genesys Administrator. See also, “IVR Server Configuration Mapping” on [page 1115](#).
6. Verify proper operation of GVP 8.1 by checking its log for errors.

## Procedures to Migrate GVP 7.6

Complete the following procedures to migrate from GVP 7.6 to GVP 8.1:

### Upgrade GVP

#### Back Up the Configuration

1. Back up the configurations of the GVP 7.6 component Application objects.

---

**Note:** Genesys recommends that you back up the GVP components individually, to help you reinstate customized configuration options later.

---

2. Shutdown GVP gracefully.

- Uninstall GVP**
3. Uninstall the 7.6 components manually in reverse order of installation:
    - a. Go to Control Panel > Add/Remove Programs.
    - b. Select the component you want to uninstall.
    - c. Click Remove.
    - d. When all of the components are uninstalled, restart the host.

For information about how to uninstall GVP 7.6 components by using the Genesys Deployment Tool or to uninstall Dialogic, see the *Genesys Voice Platform 7.6 Deployment Guide*.

---

**Note:** Uninstalling GVP software does not remove its corresponding entry in LDAP. To remove the entry from LDAP, you must delete the node for the corresponding component in the EMPS.

---

### Install GVP 8.1

#### Create and Install 8.1 Applications

4. In Genesys Administrator, create and install the Applications for the following GVP 8.1 configuration objects:
  - Fetching Module (for the Media Control Platform and Call Control Platform, respectively)
  - Resource Manager
  - Media Control Platform
  - Call Control Platform (if it is present in your deployment)
  - Reporting Server
  - CTI Connector (if you are adding it to your deployment [supported on Windows only])
  - MRCPv1 or MRCPv2 ASR and TTS servers (if they are required in your deployment)

See [Step 5 on page 1089](#) for the three ways to create Application objects for the 8.1 components.
5. Modify your configuration options in each of the 8.1 Application objects to the equivalent (or near equivalent) 7.6 configuration. See “Common Configuration Mappings” on [page 1107](#).
6. Using the Resource Group Wizard in Genesys Administrator, create the resource groups to provision the GVP resources for the GVP 8.1 Resource Manager. For more information about creating the resource groups, see the *Genesys Voice Platform 8.1 Deployment Guide*.
7. Load the GVP 8.1 Management Information Bases (MIBs) into your Simple Network Management Protocol (SNMP) management console. See “SNMP Trap Mapping” on [page 1121](#).

### Install the Reporting Server Database

8. Install and configure the Reporting Server database. For installation procedures describing the installation of Microsoft SQL Server and Oracle, see the *Genesys Voice Platform 8.1 Deployment Guide*.

For details about mapping your EventC component and real-time reporting modules to 8.1, see “Reporting Component Mapping” on [page 1120](#).

### Start GVP 8.1

9. Start the GVP 8.1 components. You can start the components in any order, except for the following requirements:
  - Start the RDBMS server for the Reporting Server database before you start the Reporting Server.
  - Start the Fetching Module (and Squid) before you start the Media Control Platform and, if applicable, the Call Control Platform.

For more information about starting and stopping GVP, see the *Genesys Voice Platform 8.1 Deployment Guide*.

10. Verify proper operation of GVP 8.1 by checking the logs for errors.

Because a GVP migration is effectively a new installation, the kinds of problems you may encounter are similar to the usual setup and startup problems for new installations. The most likely areas to check are successful database upgrade and successful importation of the old configuration. For more information about the errors you may encounter, see the *Genesys Voice Platform 8.1 Troubleshooting Guide*.

If the upgrade of any component fails, recreate and reinstall it. There is no process to rollback to GVP 7.6.

---

## Common Configuration Mappings

This section contains information about configuration mappings that are required for all GVP 7.6 deployments when you are migrating to GVP 8.1. The details are covered in these sections:

- [Component Configuration Mapping](#)
- [IVR Server Configuration Mapping on page 1115](#)
- [Reporting Component Mapping on page 1120](#)
- [Outbound Notification Mapping on page 1120](#)
- [SNMP Trap Mapping on page 1121](#)
- [System Prompts Migration on page 1124](#)

## Component Configuration Mapping

The mappings in this section describe how to migrate the EMPS configuration to the equivalent (or near equivalent) GVP 8.1 `Application` objects.

### IP Communication Server 7.6 to Media Control Platform 8.1 Mapping

The GVP 8.1 Media Control Platform supports two VoiceXML interpreter—Legacy GVPi and NGI. If you want your legacy voice and call control applications to run unchanged after migrating to GVP 8.1, you must configure GVPi as the default VoiceXML interpreter. In addition, when you are creating the IVR Profile, you must configure the `gvp.service-parameter` to use GVPi. New applications, written by using Composer are supported by the NGI only.

#### Configure Legacy GVPi

1. Configure GVPi as the default interpreter:
  - a. On the `Provisioning` tab in Genesys Administrator, select `Environment > Applications`.
  - b. Double-click the `Media Control Platform Application` object you want to configure, and click the `Options` tab.
  - c. In the `View` menu, select `Advanced View (Options)`.
  - d. In the `sessmgr` section, change the value of the `default_vxml_interpreter` option to `VXML-LGVP`.

#### Configure IVR Profile

2. Modify an existing IVR Profile to use GVPi:
  - a. On the `Provisioning` tab in Genesys Administrator, select `Voice Platform > IVR Profiles`.
  - b. Double-click the IVR Profile you want to modify, and click the `Options` tab.
  - c. In the `View` menu, select `Advanced View (Options)`.
  - d. In the `gvp.service-parameters` section, change the value of the `voicexml.gvp.appmodule` option to `fixed, VXML-LGVP`.

---

**Note:** IVR Profiles are created and configured by using the Genesys Administrator IVR Profile Wizard. The `voicexml.gvp.appmodule` option is configured automatically with the `fixed, VXML-LGVP` value when you choose `Legacy GVP` in the `Service Properties` pane of the wizard. For the procedure describing how to create IVR Profiles using Genesys Administrator, see the *Genesys Voice Platform 8.1 Deployment Guide*.

---

#### Configure MRCP Application Objects

If you are using MRCPv1 ASR and TTS servers in your 7.6 deployment, create `Speech Resource Application` objects for each server. After you have created the `Application` objects, configure them to match your GVP 7.6 configuration. Then, assign the `Application` objects to the Media Control Platform.

- Configure the `Speech Resource Application` objects:



- On the Provisioning tab in Genesys Administrator, select Environment > Applications.
- Double-click the Speech Resource Application object you want to configure, and click the Options tab.
- In the View menu, select Advanced View (Options).
- In the provision section, modify the `vrn.client.resource.uri` option to match your 7.6 configuration.

For procedures to create, configure, and assign Speech Resource Application objects using Genesys Administrator, see the *Genesys Voice Platform 8.1 Deployment Guide*.

**Additional Configuration Mapping**

Table 187 includes additional mappings to the Media Control Platform, Resource Manager, and the Environment tenant objects, and the Media Control Platform resource group object in Genesys Administrator. Some custom options in 7.6 may not be transferable to Genesys Administrator. Most PageCollector and PopGateway custom options are transferable but other custom options may not have equivalent functionality.

**Table 187: IPCS 7.6 Options Mapping**

IPCS Option (GVP 7.6)	Configuration Propagated to GVP 8.1
<b>Node: CFA</b>	
Option: Application in case of failures The value is the application that is executed if the VoiceXML start page cannot be fetched.	Resource Manager Application object Section: <code>rm</code> Option: <code>cti-unavailable-action</code> Value: <code>s;voicexml;&lt;url&gt;</code> Where <code>&lt;url&gt;</code> is the HTTP URL for the script that is executed if Computer Telephony Integration (CTI) becomes unavailable.
Option: Default DNIS The value is the DID that is used if DNIS is not available.	Environment Tenant object Section: <code>gvp.general.section</code> Option: <code>default-application</code> Value: <code>&lt;IVRProfileName&gt;</code> Where <code>&lt;IVRProfileName&gt;</code> is the name of the IVR Profile created in Genesys Administrator (8.1) that will be used if the DNIS cannot be ascertained. The start URL is specified in the IVR Profile.

**Table 187: IPCS 7.6 Options Mapping (Continued)**

IPCS Option (GVP 7.6)	Configuration Propagated to GVP 8.1
<b>Node: PopGateway1/Route1</b>	
Option: Max Channels	<p>Media Control Platform Resource Group object</p> <p>Using the Resource Group Wizard in Genesys Administrator, Media Control Platform Application objects are grouped to provide load balancing for the resources within the group.</p> <p>In the Resource Assignment pane of the wizard, enter a number for Max Channels in the Max Ports field.</p>
<b>Node: PopGateway1</b>	
Option: SIP Header for DID	<p>Resource Manager Application object</p> <p>Section: rm</p> <p>Option: sip-header-for-dnis</p>
Option: Hangup Cause Fetch Error (INI name: hangupcause_fetcherror)	<p>Media Control Platform Application object</p> <p>Section: PopGateway1</p> <p>Option: hangupcause_fetcherror</p>
Option: Hangup Cause Internal Error (INI name: hangupcause_internalerror)	<p>Media Control Platform Application object</p> <p>Section: PopGateway1</p> <p>Option: hangupcause_internalerror</p>
Option: Hangup Cause Parse Error (INI name: hangupcause_parseerror)	<p>Media Control Platform Application object</p> <p>Section: PopGateway1</p> <p>Option: hangupcause_parseerror</p>
Option: Hangup Cause Resource Unavailable (INI name: hangupcause_rscunavailable)	<p>Media Control Platform Application object</p> <p>Section: PopGateway1</p> <p>Option: hangupcause_rscunavailable</p>
Option: Session Timer Interval	<p>Media Control Platform Application object</p> <p>Section: sip</p> <p>Option: sessionexpires</p>
Option: OutboundDefaultSANI	<p>Media Control Platform Application object</p> <p>Section: sip</p> <p>Option: defaultfrom</p>

**Table 187: IPCS 7.6 Options Mapping (Continued)**

IPCS Option (GVP 7.6)	Configuration Propagated to GVP 8.1
Option: Local IP Address	Media Control Platform Application object Section: sip Option: transport.0
<b>Node: MCU</b>	
Option: Inband DTMF Edge Detection	Media Control Platform Application object Section: mpc Option: dtmf.detectedge
Option: Inband DTMF Interdigit Silence	Media Control Platform Application object Section: mpc Option: dtmf.maxsilence
Option: Inband DTMF Minimum Duration	Media Control Platform Application object Section: mpc Option: dtmf.minduration
Option: Fallback DTMF mode	Media Control Platform Application object Section: mpc Option: dtmf.send, dtmf.receive
<b>Node: MCU&gt;TTS&gt;MRCP</b>	
Option: Out of Service Ping Interval (seconds)	Media Control Platform Application object Section: vrm Option: SRM Ping Frequency Specify the value in milliseconds.
<b>Node: PageCollector</b>	
Option: HTTP Caching (INI name: cachemode)	Media Control Platform Application object Section: PageCollector Option: cachemode
Option: Host Cache List (INI name: hoststobecached)	Media Control Platform Application object Section: PageCollector Option: hoststobecached

**Table 187: IPCS 7.6 Options Mapping (Continued)**

IPCS Option (GVP 7.6)	Configuration Propagated to GVP 8.1
Option: ProxyServer List (INI name: proxyList)	Media Control Platform Application object Section: PageCollector Option: proxyList
Option: Proxy Bypass List (INI name: proxybypassList)	Media Control Platform Application object Section: PageCollector Option: proxybypassList

### GQA (IVR Server Client) 7.6 to CTI Connector 8.1 Mapping

This configuration mapping is not required if there are no CTI components in your 7.6 deployment. If you are using CTI components in any configuration—in-front of the switch, behind the switch, or network mode—complete the following tasks.

1. For each customer in EMPS 7.6:
  - a. Select Resellers > View Customers Provisioning Information:
  - b. On the GenesysCTI tab, check to see if the IVR Server Client Active box is checked.
  - c. If the Active box is checked, install and configure a CTI Connector Application object in Genesys Administrator for each Primary IVR Server Client Machine name found in the list of EMPS customers.

---

**Note:** Genesys recommends that a CTI Connector Application is installed and configured (on a separate host) for each GQA host (not process) in GVP 7.6. To determine the number of CTI Connectors required for your call volumes and configuration, see the Genesys Hardware Sizing Guide.

---

- IServer Customer List for CTIC**
2. If you have a common set of IVR Servers (no primary or secondary servers), with the same version number and configuration in GVP 7.6 and GVP 8.1:
    - a. In Genesys Administrator, double-click the CTI Connector Application object.
    - b. On the Options tab, in the View menu, select Advanced View (Options).
    - c. In the IVRSC section, modify the value of the customeriserverslist option by listing each IServer section separated by a semi-colon(;)—for example:  
IServer\_Sample1; IServer\_Sample2; IServer\_Sample3
    - d. Using the customer names in the customeriserverslist, create a separate IVRSC section for each IVR Server associated with the CTI Connector Application object.

e. In each newly created IVRSC section, edit the following options:

- clientname = CME IVR Client Name
- iserveraddr = <IP Address of IVR Server>
- iserversocket = <GLI Port of IVR Server>

where <CME IVR Client Name> is the name of the IVR Server client, <IP Address of IVR Server> is the IP address of the IVR Server client, and <GLI Port of IVR Server> is the Generic Layer Interface (GLI) Port of the IVR Server client. This information is found in EMPS by navigating to the Servers > Iservers > IserverInfo, under the specific IServer node.

3. In the CTIC section, modify the value of the RMIPAddr option, enter the IP address of the Resource Manager.

#### Additional Configuration Mappings in IVR Profiles

4. The following configuration options from the EMPS <Reseller>\_<Customer>\_GQA node can be configured in the IVR Profile object, however, IVR Profiles are generally created and configured by using the Genesys Administrator IVR Profile Wizard. These options are not configured when GVP 7.6 is in standalone mode. See “IVR Server Configuration Mapping” on [page 1115](#).

**Table 188: EMPS GQA (IVR Server Client) Options Mapping**

GQA Option (GVP 7.6)	Configuration Propagated to (GVP 8.1)
Node: <Reseller>_<Customer>_GQA (INI name: cti.FetchScriptIdFromURS)	IVR Profile Section: gvp.service-parameters Option: cti.FetchScriptIdFromURS
Node: <Reseller>_<Customer>_GQA (INI name: ScriptIdKeyName)	IVR Profile Section: gvp.service-parameters Option: ScriptIdKeyName

When GVP 7.6 is installed in single-tenant mode, a set of IVR Servers is assigned to the IPCS/VCS. The configuration option is found in EMPS on the GenesysCTI tab. Select the GVPOwner reseller section of the Admin customer and you will find the LocalISvrClient enabled. There is not equivalent configuration in GVP 8.1. You cannot assign a group of CTI Connectors to the Media Control Platform; CTI Connectors are assigned to the Resource Manager in GVP 8.1.

#### Resource Manager, SIP Session Manager, Policy Manager 7.6 to Resource Manager 8.1 Mapping

The Resource Managers role in GVP 8.1 is significantly different than in GVP 7.6., for example, the 8.1 Resource Manager:

- Functions as a proxy. (In 7.6, it functioned as a redirector.)

- Functions as a SIP Session Manager together with SIP Server. (There is not a separate SIP Session Manager in 8.1.)
- Stores resource information in memory. (There is no database as there is in 7.6 [Polyhedra].)
- Manages GVP resources (Media and Call Control Platforms, CTI Connectors). (Resource do not register with the Resource Manager as they did in 7.6.)
- Manages policies for IVR Profiles. (There is not a separate Policy Manager as in 7.6.)

### Create Resource Groups

To ensure that the configuration in the GVP 7.6 Resource Manager, SIP Session Manager, and Policy Managers is equivalent in GVP 8.1 Resource Manager, complete the following tasks:

1. Create a resource access point or Gateway Application object for the SIP Server using the Create Application Wizard in Genesys Administrator. See [Step 5 on page 1089](#) for the various ways to create and install Applications.
2. Create resource groups using the Resource Group Wizard in Genesys Administrator.
  - a. Create a Gateway Group for the SIP Server resource.
  - b. Create a CTIC Group for CTI Connector resources.
  - c. Create a MCP Group for Media Control Platform resources.

You will find information about how to create and configure all of these resource groups in the *Genesys Voice Platform 8.1 Deployment Guide*.

---

**Note:** In terms of migration, it is not necessary to create a CCP Group for the Call Control Platform resources because the GVP 7.6 does not support CCXML applications, however, although the Call Control Platform is an optional component in GVP 8.1, CCXML applications are fully supported.

In addition, if your 7.6 deployment is configured in standalone mode, it is not necessary to create a CTI Group.) See “IVR Server Configuration Mapping” on [page 1115](#).

---

The default values for all other mandatory Resource Manager options are sufficient to make the initial call to test system functionality, however, some

additional configuration options are mapped to 8.1 IVR Profiles. See [Table 189](#).

**Table 189: Resource Manager, SIP Session Manager, Policy Manager 7.6 Options Mapping**

RM/SSM/PM Options (GVP 7.6)	Configuration Propagated to GVP 8.1
Node: <Reseller>_<Customer>_Policy Option: Level 1 Ports	IVR Profile Section: gvp.service-parameters Option: cti.FetchScriptIdFromURS
Node: <Reseller>_<Customer>_Policy Option: Level 2 Ports	IVR Profile Section: gvp.service-parameters Option: cti.FetchScriptIdFromURS
Node: <Reseller>_<Customer>_Policy Option: Level 3 Ports	IVR Profile Section: gvp.service-parameters Option: cti.FetchScriptIdFromURS

## IVR Server Configuration Mapping

This section describes how to migrate your configuration by providing mapping information for these specific GVP 7.6 deployment scenarios:

- “Behind the Switch Mode”
- “In-front of the Switch Mode” on [page 1117](#)
- “Network Mode” on [page 1118](#)
- “Standalone Mode” on [page 1119](#)

The terms, *behind the switch*, *in-front of the switch*, *Standalone*, and *Network mode* do not necessarily describe how GVP is configured to operate in relation to the switch, but actually describes the configuration of IVR Server.

For information about how the CTI Connector is configured to support IVR Server, see the *Genesys Voice Platform 8.1 Deployment Guide*. For information about how SIP Server and IVR Server are configured in various deployment scenarios, see the *Voice Platform Solution 8.1 Integration Guide*.

### Behind the Switch Mode

The most common behind-the-switch configuration is implemented when IVR Server is behind the switch and GVP is in front of the switch. One of the advantages to using this configuration is that it supports the use of more than one IVR Server client.

If your GVP 7.6 deployment is configured to operate in behind-the-switch mode, you can configure the GVP 8.1 CTI Connector, Resource Manager, and

IVR Profiles to support this configuration. However, some configuration options in EMPS cannot be migrated to 8.1, specifically:

- In IPCS > PopGateway node > SIP tab > SIP Header for IVR Port attribute—may have a value of No Selection, To, or Request URI.
- In IPCS > PopGateway1 node > IVR tab > Primary DID Mapper attribute—may have a value of  
http://localhost:9810/did\_url\_mappings/GenericDID.xml or  
http://localhost:9810/did\_url\_mappings/\$did\$.xml).

Table 190 shows the configuration options in EMPS that can be migrated to 8.1.

**Table 190: EMPS IPCS 7.6 Options Mapping—Behind the switch**

IPCS (GVP 7.6)	Configuration Propagated to GVP 8.1
Node: CFA > General tab Option: Use CTI Client for ANI & DNIS Value: 1 or 0	<ul style="list-style-type: none"> <li>• CTI Connector Application object Section: CTIC Option: DNSIndicator Value:</li> </ul>
Node: PopGateway > SIP tab Option: SIP Header for DID Value: No Selection or History-Info	<ul style="list-style-type: none"> <li>• If CTI Client for ANI &amp; DNIS = 1, DNSIndicator = IVR Server</li> <li>• If SIP Header for DID = History-Info in the IPCS PopGateway &gt; SIP node, DNSIndicator = HistoryInfoHeader</li> <li>• If SIP Header for DID = No Selection in the IPCS PopGateway &gt; SIP node, DNSIndicator = ToHeader</li> <li>• If CTI Client for ANI &amp; DNIS = 0, Resource Manager Application object Section: rm Option: sip-header-for-dnis Value: Either HistoryInfoHeader or ToHeader (should match the value that was entered for DNSIndicator above.)</li> </ul>
Node: CFA > General tab Option: Transfer Type Value: Transfer Through CTI or Platform Transfer	IVR Profile Section: gvp.service-parameters Option: cti.TransferOnCTI Value: <ul style="list-style-type: none"> <li>• If Transfer Type = Transfer Through CTI, cti.TransferOnCTI = fixed, yes</li> <li>• If Transfer Type = Platform Transfer, cti.TransferOnCTI = fixed, no</li> </ul>



GVP 7.6 can be deployed in behind-the-switch mode, in three scenarios:

- With SIP Server 7.6.
- With multiple Media Gateways and MG Groups that communicate directly with Resource Manager and SIP Session Manager, but with no SIP Server.
- With a softswitch communicating with Resource Manager and SIP Session Manager, but with no SIP Server.

During the migration to GVP 8.1, the Media Gateway and softswitch in the last two scenarios must be configured to inter operate with SIP Server. For information about how to configure these elements, see the *Framework 7.6 Deployment Guide*.

### In-front of the Switch Mode

If your GVP 7.6 deployment is configured to operate in front of the switch, you can configure the GVP 8.1 CTI Connector, Resource Manager, and IVR Profiles to support this configuration. However, some configuration options in EMPS cannot be migrated to 8.1, specifically:

- In IPCS > PopGateway node > SIP tab > SIP Header for IVR Port attribute—may have a value of No Selection, To, or Request URI.
- In IPCS > PopGateway1 node > IVR tab > Primary DID Mapper attribute—may have a value of `http://localhost:9810/did_url_mappings/$did$.xml`.

[Table 191](#) shows the configuration options in EMPS that can be migrated to 8.1

**Table 191: EMPS IPCS 7.6 Options Mapping—In-front of the switch**

IPCS (GVP 7.6)	Configuration Propagated to GVP 8.1
Node: CFA > General tab Option: Use CTI Client for ANI & DNIS Value: 0	<ul style="list-style-type: none"> <li>CTI Connector Application object                Section: CTIC                Option: DNSIndicator                Value:</li> </ul>
Node: PopGateway > SIP tab Option: SIP Header for DID Value: No Selection or History-Info	<ul style="list-style-type: none"> <li>If SIP Header for DID = History-Info in the IPCS PopGateway&gt;SIP node,                DNSIndicator = HistoryInfoHeader</li> <li>If SIP Header for DID = No Selection in the IPCS PopGateway&gt;SIP node,                DNSIndicator = ToHeader</li> <li>Resource Manager Application object                Section: rm                Option: sip-header-for-dnis                Value: Either HistoryInfoHeader or ToHeader (should match the value that was entered for DNSIndicator above)</li> </ul>
Node: CFA > General tab Option: Transfer Type Value: Platform Transfer	IVR Profile Section: gvp.service-parameters Option: cti.TransferOnCTI Value: fixed, no

### Network Mode

If your GVP 7.6 deployment is configured to operate in network mode, you can configure the GVP 8.1 CTI Connector and Resource Manager to support this configuration. However, some configuration options in EMPS cannot be migrated to 8.1, specifically:

- In IPCS > PopGateway node > SIP tab > SIP Header for IVR Port attribute—may have a value of No Selection, To, or Request URI.
- In IPCS > PopGateway1 node > IVR tab > Primary DID Mapper attribute—may have a value of `http://localhost:9810/did_url_mappings/$did.xml`.

Table 192 shows the configuration options in EMPS that can be migrated to 8.1

**Table 192: EMPS IPCS 7.6 Options Mapping—Network Mode**

IPCS (GVP 7.6)	Configuration Propagated to GVP 8.1
Node: CFA > General tab Option: Use CTI Client for ANI & DNIS Value: 0	<ul style="list-style-type: none"> <li>• CTI Connector Application object                Section: CTIC                Option: DNSIndicator                Value:</li> </ul>
Node: PopGateway > SIP tab Option: SIP Header for DID Value: No Selection or History-Info	<ul style="list-style-type: none"> <li>• If SIP Header for DID = History-Info in the IPCS PopGateway&gt;SIP node,                DNSIndicator = HistoryInfoHeader</li> <li>• If SIP Header for DID = No Selection in the IPCS PopGateway&gt;SIP node,                DNSIndicator = ToHeader</li> <li>• Resource Manager Application object                Section: rm                Option: sip-header-for-dnis                Value: Either HistoryInfoHeader or ToHeader                (should match the value that was entered for DNSIndicator above)</li> </ul>
Node: CFA > General tab Option: Transfer Type Value: Platform Transfer	IVR Profile Section: gvp.service-parameters Option: cti.TransferOnCTI Value: fixed, no
Node: EMPS > Customer Provisioning > GenesysCTI tab Option: IVR Server Mode Value: Network Option: Called Num Value: DNIS or TFN	CTI Connector Application object Section: ctic Option: cti.UseCalledNumAs Value: Either DNIS or TFN (should match the value that was entered in the Called Num option in EMPS)

### Standalone Mode

If your GVP 7.6 deployment is configured to operate in standalone mode, you can configure the GVP 8.1 CTI Connector, Resource Manager, and IVR Profiles to support this configuration.

When GVP 7.6 is configured in standalone mode, CTI functionality is not enabled (in EMPS > Customer > GenesysCTI tab > IVR Server Active, the checkbox is unchecked). Therefore, when you create the Gateway Resource

Group for SIP Server in GVP 8.1, you must select `Always Off` for the CTI Usage option.

See Table 191 on [page 1118](#) for additional configuration (from 7.6 EMPS) that must be migrated to GVP 8.1.

## Reporting Component Mapping

You must install a new installation of Reporting Server to upgrade your systems to GVP 8.1 to obtain historical and real-time reporting data. GVP 8.1 includes enhanced reporting functionality within new platform architecture and although there may be similarities to the functionality in GVP 7.6, there is no direct migration process. For more information about the GVP 8.1 reporting architecture, see the *Genesys Voice Platform 8.1 Deployment Guide*.

### Real-time, Historic, and VAR Reports

GVP 8.1 is tightly integrated with Genesys Administrator, a web-based GUI that provides access to Real-Time, Historic, and Voice Application Reports (VAR), similar to the Unified Login Server (ULS) and VAR GUIs in GVP 7.6. Genesys Administrator retrieves information about components and voice and call control applications (IVR Profiles) from the Configuration Database, and provides access to the Historic reports.

### Peak Reports and Call Status Monitoring

As in GVP 7.6, Call Peak Reports are available for IVR Profiles and components, providing hourly, daily, weekly, and monthly reporting metrics. In addition, the Genesys Administrator Dashboard, provides status information similar to the Call Status Monitor in GVP 7.6.

### Legacy VoiceXML Applications

You can continue to use Genesys Studio 7.6 and Voice Application Reporter (VAR) 7.6 after migrating to GVP 8.1. Legacy VoiceXML applications can be modified only in Studio and application reporting is available only by using VAR. VoiceXML applications created by using Composer are supported by the NGI only and the associated VAR reports are accessed by using Genesys Administrator in GVP 8.1.

For detailed information about how GVP 8.1 logs data and provides reports, or for information about the Genesys Administrator Dashboard, or Historic and VAR reporting interfaces, see the *Genesys Voice Platform 8.1 User's Guide*.

## Outbound Notification Mapping

The 7.6 Outbound Notification (OBN) component maps directly to the 8.1.1 Supplementary Services Gateway (SSG) component. The Supplementary Services Gateway replaces OBN (which is not supported in GVP 8.x) and provides a similar, but richer HTTP interface for placing outbound calls.

---

**Note:** The Supplementary Services Gateway also replaces the VoiceGenie (VG) remedial, which is now deprecated.

---

To migrate from OBN-based outbound calling to the Supplementary Services Gateway, complete the following steps:

1. Update the trigger applications used to initiate outbound requests through OBN to conform to the new Supplementary Services Gateways XML schema. Compare the OBN schema to the Supplementary Services Gateways schema to determine what must be modified. For a complete description and example of the Supplementary Services Gateway schema, see the *Genesys Voice Platform 8.1 User's Guide*.
2. Genesys recommends that you migrate any VoiceXML applications that require the use of the Legacy GVP 7.6 interpreter. Of the two GVP VoiceXML interpreters, the Supplementary Services Gateway supports only the Next Generation Interpreter (NGI) for outbound calling.

For information about migrating GVP 7.6 Voice Extensible Markup Language (VoiceXML) and Telera XML (TXML) applications, see the *Genesys Voice Platform 8.1 Application Migration Guide*.

For more information about how the Supplementary Services Gateway functions and how it interacts with trigger applications and SIP Server, see the *Genesys Voice Platform 8.1 Deployment Guide*.

## SNMP Trap Mapping

Both GVP 7.6 and GVP 8.1 components generate traps that can be viewed by using an SNMP Management Console, and the MIBs, which are loaded on the console host, are included in the Installation Packages (IP) for both platforms. However, the SNMP traps and MIBs differ between 7.6 and 8.1.

This section provides trap mapping tables to assist you in determining which traps to enable to monitor your environment for unexpected or unallowable conditions, in order to prevent them from reoccurring.

For more information about SNMP traps and the MIBs, see the *Genesys Voice Platform 8.1 Troubleshooting Guide*.

[Table 193](#) contains GVP 7.6 ASR and TTS to GVP 8.1 Media Control Platform trap mappings.

**Table 193: ASR/TTS to Media Control Platform Trap Mappings**

In GVP 7.6	In GVP 8.1
cnASRServerError	MCP_SRM_MRCPADPT_ASR_SERVER_ERROR
cnASRRequestTimeout	MCP_SRM_MRCPADPT_ASR_REQUEST_TIMEOUT
cnASRRequestConnFailure	MCP_SRM_MRCPADPT_ASR_REQUEST_SEND_FAILURE
cnASRErrorResponse	MCP_SRM_MRCPADPT_ASR_MRCP_ERROR_RESPONSE
cnASRErrorEvent	MCP_SRM_MRCPADPT_ASR_MRCP_ERROR_EVENT

**Table 193: ASR/TTS to Media Control Platform Trap Mappings (Continued)**

In GVP 7.6	In GVP 8.1
cnTTSTrap	Obsolete. Used for native TTS integration.
cnTTSRequestAbandoned	
cnTTSRequestRejected	
cnTTSTMaxSizeExceeded	
cnTTSNoLangSupport	
cnTTSRequestInvalid	
cnTTSConversionError	
cnTTSWriteError	
cnTTSInitializationError	MCP_SRM_MRCPADPT_FAIL_LOADING_MRCP_MODULE MCP_SRM_MRCPADPT_CONFIGURATION_ERROR
cnTTSServerError	MCP_SRM_MRCPADPT_TTS_SERVER_ERROR
cnTTSRequestTimeout	MCP_SRM_MRCPADPT_TTS_REQUEST_TIMEOUT
cnTTSRequestConnFailure	MCP_SRM_MRCPADPT_TTS_REQUEST_SEND_FAILURE
cnTTSErrorResponse	MCP_SRM_MRCPADPT_TTS_MRCP_ERROR_RESPONSE
cnTTSErrorEvent	MCP_SRM_MRCPADPT_TTS_MRCP_ERROR_EVENT

Table 194 contains GVP 7.6 Policy Manager, SIP Session Manager, and Resource Manager to GVP 8.1 Resource Manager trap mappings.

**Table 194: PM/SSM/RM to Resource Manager**

In GVP 7.6	In GVP 8.1
<b>Policy Manager (PM)</b>	
cnAppOutAllPortsBusy	GVPLOG_RM_POLICYVIOLATIONERROR, GVPLOG_RM_BURSTAPPBEGIN
cnAppOutAllPortsNotBusy	GVPLOG_RM_POLICYVIOLATIONERROR, GVPLOG_RM_BURSTAPPEND
cnCustSessionAllPortsBusy	GVPLOG_RM_POLICYVIOLATIONERROR, GVPLOG_RM_BURSTTENANTBEGIN

**Table 194: PM/SSM/RM to Resource Manager (Continued)**

In GVP 7.6	In GVP 8.1
cnCustSessionAllPortsNotBusy	GVPLOG_RM_POLICYVIOLATIONERROR, GVPLOG_RM_BURSTTENANTEND
cnAppSessionAllPortsBusy	GVPLOG_RM_POLICYVIOLATIONERROR
cnAppSessionAllPortsNotBusy	GVPLOG_RM_POLICYVIOLATIONERROR
cnPMStarted	GVPLOG_RM_STARTUP
cnPMDown	GVPLOG_RM_SHUTDOWN
cnPMAppAdded	Not relevant in 8.1
cnPMAppRemoved	Not relevant in 8.1
<b>Resource Manager (RM)</b>	
cnRMDatabaseError	Not relevant in 8.1
<b>SIP Session Manager (SSM)</b>	
cnSSMResourceNotAvail	GVPLOG_RM_RESOURCEALLOCERR, GVPLOG_RM_NOMATCHINGSERVICETYPE, GVPLOG_RM_NOMATCHINGGWREFERENCE
cnSSMCommFailure	Not relevant in 8.1
cnSSMDatabaseError	Not relevant in 8.1
cnSSMDIDXMLError	GVPLOG_RM_DNISNOTEXIST
cnSSMCallTransferred	Not relevant in 8.1
cnNetworkError	GVPLOG_RM_APPPROFILENOTFOUND, GVPLOG_RM_DEFAULTIVRPROFILENOTFOUND

[Table 195](#) contains GVP 7.6 GQA (IVR Server Client) to GVP 8.1 CTI Connector trap mappings.

**Table 195: GQA (IVR Server Client) to CTI Connector**

In GVP 7.6	In GVP 8.1
cnIQANetworkUpTrap	CTIC_IVR_SERVER_UP
cnIQANetworkFailureTrap	CTIC_IVR_SERVER_DOWN

**Table 195: GQA (IVR Server Client) to CTI Connector (Continued)**

In GVP 7.6	In GVP 8.1
cnIQAStratedTrap	Not relevant in 8.1
cnIQADownTrap	Not relevant in 8.1

## System Prompts Migration

You can migrate your GVP 7.6 system prompts to GVP 8.1 by copying the .vox files from the folder in IPCS (7.6) to the folder on the Media Control Platform.(8.1). [Table 196](#) contains a list of the GVP 7.6 prompts that can be transferred.

**Table 196: GVP 7.6 System Prompts**

Filename	Output	Description
BadFetchError.vox	error.badfetch	Sorry. You have got a bad fetch error. Exiting.
NoAuthorizationError.vox	error.noauthorization	Sorry. No Authorization error. Exiting.
SemanticError.vox	error.semantic.UnsupportedAudioFormat	Sorry. You have got a semantic error. Exiting.
Error.vox	error.unsupported.format	Sorry. The specified audio format is not supported. Exiting.
	error	Sorry. You have an error. Exiting.
UnsupportedLangError.vox	error.unsupported.language	Sorry. The specified language is not supported. Exiting.
SpokeTooEarly.vox	nomatch.com.telera.speechtooearly	Sorry. Could you please repeat? You spoke too early.
NoMatch.vox	noinput	Sorry. I did not understand.
NoInput.vox		Sorry. I did not hear you.
Help.vox	help	Sorry. There is no help provided.



**Table 196: GVP 7.6 System Prompts (Continued)**

Filename	Output	Description
MaxSpeechTimeout.vox	maxspeectimeout	Sorry. The speech input is too long.
NoCatchHandler.vox	All other errors	Sorry. There is no catch handler provided. Exiting.





**Part**

# 20

## **The Gplus Adapter 7 for mySAP ERP Migration**

This section discusses the preliminary migration procedures and the migration order for the *Gplus* Adapter 7 for mySAP ERP. This Part contains the following chapters:

- Chapter 65, “Introduction to the *Gplus* Adapter 7 for mySAP ERP Migration,” on page 1129 discusses the preliminary migration procedures and the migration order for the *Gplus* Adapter 7 for mySAP ERP.
- Chapter 66, “Changes in Configuration Options for the *Gplus* Adapter 7 for mySAP ERP,” on page 1137 discusses changes (additions, deletions, and modifications) in the product that need specifically to be addressed during the migration process.
- Chapter 67, “Migration Procedures,” on page 1145 discusses the migration procedures for release 6.1 of T-Gate to the *Gplus* Adapter 7 for mySAP ERP.





## Chapter

# 65

## Introduction to the Gplus Adapter 7 for mySAP ERP Migration

This chapter discusses the preliminary migration procedures and the migration order for the *Gplus* Adapter 7 for mySAP ERP.

There are three main sections in this chapter:

- [Preliminary Migration Procedures, page 1129](#)
- [Migration and Upgrade Order, page 1130](#)
- [Additional Information about Migration, page 1131](#)

---

## Preliminary Migration Procedures

---

**Note:** If you want to upgrade your operating system before migrating your Genesys product, contact Professional Services.

---

The migration process includes these preliminary procedures for the *Gplus* Adapter 7 for mySAP ERP:

1. Review Chapter 2, “Licensing Migration,” on [page 41](#) for more information about licensing, and Part 2, “Framework Migration” on [page 57](#), for the compatibility among different versions of Genesys products and general migration notes for Genesys Framework components.
2. Examine “Migration and Upgrade Order” on [page 1130](#).
3. Look at the option changes in “Changes to Configuration Options for the Gplus Adapter” on [page 1138](#).

---

**Notes:**

- Please note that these tables only discuss changes that directly affect the migration to this product from 6.1 T-Gate.
- For complete information about what's new in this release of the *Gplus Adapter 7 for mySAP ERP* and how this version functions, please see the *Gplus Adapter 7 for mySAP ERP Getting Started Guide* and the *Gplus Adapter 7 for mySAP ERP Deployment Guide*.
- For a complete list of documentation relevant to the migration of this product, see “[Reference Materials](#)” below.

- 
4. Review other issues pertaining to the migration of the 6.1 T-Gate product to the *Gplus Adapter 7 for mySAP ERP*.

## Reference Materials

- *Gplus Adapter 7 for mySAP ERP Getting Started Guide*
- *Gplus Adapter 7 for mySAP ERP Deployment Guide*
- *Gplus Adapter 7 for mySAP ERP Release Notes*

---

## Migration and Upgrade Order

This section is specific to the applications and components that enable or support the *Gplus Adapter 7 for mySAP ERP*, and describes migration and upgrade order from the 6.1 T-Gate product to the *Gplus Adapter 7 for mySAP ERP* and other enabling software and relevant data.

**To migrate to  
*Gplus Adapter 7*  
for mySAP ERP**

Migrate or upgrade the 6.1 T-Gate product to the *Gplus Adapter 7 for mySAP ERP*, other enabling software, and relevant data for this *Gplus Adapter* in the following order:

---

**Note:** See procedures detailing this order in “Migration of 6.1 T-Gate to the *Gplus Adapter 7 for mySAP ERP*” on [page 1145](#).

---

1. Migrate and upgrade prerequisite Genesys Framework components. The *Gplus Adapter 7 for mySAP ERP* is designed to work with Genesys Framework 7.0, and is compatible with Genesys Framework 6.5. It is recommended that you upgrade Genesys Framework if you have an earlier version installed.

See Part 2, “Framework Migration” on [page 57](#) and other related Genesys documentation for more information.

2. Migrate settings from 6.1 T-Gate Configuration Manager to Genesys Configuration Manager.

This includes migrating:

- Server Configuration and Configuration Profiles
- Queue Configuration
- Multiple DN Configuration

See “Migration of 6.1 T-Gate to the Gplus Adapter 7 for mySAP ERP” on [page 1145](#) for these procedure details.

3. Install and configure the *Gplus* Adapter 7 for mySAP ERP.

Find information about installing and configuring the *Gplus* Adapter in the *Gplus Adapter 7 for mySAP ERP Deployment Guide*. Since the *Gplus* Adapter and 6.1 T-Gate use many similar configuration options, see “Changes to Configuration Options for the Gplus Adapter” on [page 1138](#) to facilitate option migration.

4. Set up new configuration options that are available in the *Gplus* Adapter 7 for mySAP ERP, but were not available in 6.1 T-Gate.
5. Migrate routing strategies.
6. Review other existing differences between the *Gplus* Adapter 7 and 6.1 T-Gate:
  - Read about differences in CAD handling in this chapter.
  - Read about known problems and limitations in the product Release Notes.

---

## Additional Information about Migration

The following information is also pertinent to the migration of 6.1 T-Gate to the *Gplus* Adapter 7 for mySAP ERP.

### Differences in Call Handling

There are differences between 6.1 T-Gate and the *Gplus* Adapter 7 for mySAP ERP in the way calls are handled. Specifically, this section reviews the following:

- Differences in behavior when releasing held calls
- Differences in behavior when dropping conference calls

### Releasing Held Calls

The following is an example of a consult call situation in which 6.1 T-Gate and the *Gplus* Adapter 7 behave differently.

An agent (A) is talking to a customer (B), and makes a consult call to another agent (C). This causes the original call (A—B) to be placed on *hold*, while the consult call is *connected* (A—C).

Agent A now selects Hang Up All Calls.

T-Gate releases all calls (both the held call and the connected call). If the switch does not support the *hang up all* function in this situation, T-Gate will first retrieve the held call, then release it.

The *Gplus* Adapter's behavior is in line with how the switch operates. If the switch supports the *hang up all* function in this situation, the Adapter will release both the held and the connected call. If the switch does not support this function, the Adapter will release the connected call, but *not* the held call. The agent will need to retrieve the held call manually and then release it.

## Dropping Conference Calls

The following is an example of a conference call situation in which 6.1 T-Gate and the *Gplus* Adapter 7 behave differently.

An agent (A), a customer (B), and another agent (C) are engaged in a three-party conference call.

Agent A now selects Hang Up All Calls.

---

**Note:** If the switch supports the behavior, Customer B or Agent C may also be able to initiate Hang Up All Calls.

---

T-Gate releases all calls and drops the conference.

The *Gplus* Adapter only drops the party who requested Hang Up All Calls. The conference remains in effect as long as there are at least two parties still connected.

## Differences in Call-Attached Data Handling

This section describes differences in call-attached data (CAD) handling when migrating from 6.1 T-Gate to the *Gplus* Adapter 7 for mySAP ERP.

### Call-Attached Data Representation

The SAPphone specification defines how CAD should be represented in SAP, but the gateway representation is vendor-specific. Therefore, even when SAP CAD is the same, call-attached data can be different for T-Gate and for the *Gplus* Adapter 7 for mySAP ERP. For details about how the *Gplus* Adapter handles CAD, please see the *Gplus Adapter 7 for mySAP ERP Deployment Guide*.

The T-Gate and Adapter representation is two level: *public* based on parsing the top-level key-value pair, and *internal* (instance numbers, additional fields).



Top-level (public) representations are compatible, but internal representations are not.

The Adapter parses top-level data based on an algorithm similar to T-Gate’s, and uses a tree structure to store parsed data (internal representation) in call-attached data.

T-Gate also parses top-level data and then attaches its internal representation to the call, but this internal representation is different. It encodes instance numbers into key names on the top level of the Genesys call-attached data.

In conclusion, T-Gate’s internal data representation and that of the *Gplus* Adapter for mySAP ERP are *not* compatible. However, if IVR/IRD uses the *public format* for call-attached data as specified in 6.1 T-Gate and the *Gplus* Adapter documentation, this call-attached data should be understandable by both applications.

### Changes in Routing Strategies

If you use a routing strategy to propagate call-attached data (CAD) to SAP, and your routing strategy uses the internal T-Gate data representation, you should change this routing strategy to use the *public format* of SAP CAD without an instance number. If you require an instance number, you must use the internal Genesys representation of SAP CAD (which is not recommended unless necessary). Table 197, “Routing Strategy Change: T-Gate and Gplus Adapter,” on [page 1133](#) shows an example.

**Table 197: Routing Strategy Change: T-Gate and Gplus Adapter**

T-Gate	Gplus Adapter for mySAP ERP
<pre>Update('SAPCIC_CIC_CTI__0001__CUSTANI', '1234567')</pre>	Using default options: <pre>Update('SAPCUST_CIC_CTI__CUSTANI', '1234567')</pre>
	Change call-attached-data: custom=SAPCIC_ <pre>Update('SAPCIC_CIC_CTI__CUSTANI', '1234567')</pre>
	For 7 IRD, it is possible to use the internal format to specify an instance number.  The options <code>root-key</code> and <code>instance-key</code> are defined in the <code>call-attached-data</code> section. With default options ( <code>root-key=SAPCAD</code> , <code>instance-key=_instance</code> ): <pre>Update('SAPCIC_CIC_CTI__CUSTANI', '1234567')</pre> <pre>Update('SAPCAD.CIC_CTI._instance', '0001')</pre> <pre>Update('SAPCAD.CIC_CTI.CUSTANI', '1234567')</pre>

## Why is Data Attached by T-Gate Not Recognized by the Gplus Adapter?

The SAPphone specification does not specify how data should be stored in the Telephony Gateway and/or the CTI system. Therefore, it is up to the Gateway to specify this information.

The public formats for all supported CAD types supported are specified in the 6.1 T-Gate documentation. However, after receiving the data, 6.1 T-Gate transforms CAD to its own internal representation, and all further actions are performed with the transformed data.

For this reason, the *Gplus* Adapter cannot read CAD attached by 6.1 T-Gate. Since the internal representation format is not specified, it cannot be safely used by third-party systems.

The *Gplus* Adapter also uses its internal format to store CAD, but it supports operations with public format as well. (This is the same as for 6.1 T-Gate.) Therefore, CAD which the *Gplus* Adapter adds is recognized by 6.1 T-Gate.

## Call-Attached Data for Consult Calls

There is a difference in how the *Gplus* Adapter 7 for mySAP ERP and 6.1 T-Gate operate with call-attached data (CAD) after an SAP agent makes a consult call.

This difference is related to the fact that all CAD modifications made on the connected consult call become available to the originator at the same time, while the *Gplus* Adapter *separates* CAD between the originator and consult parties.

The following use-case scenario shows this difference in more detail.

To execute this scenario, set up three SAP agents (dnA, dnB, and dnC) and take the following steps from SAP using transaction SPHT:

1. dnA makes a call to dnB.
2. dnB accepts the incoming call.
3. Attach some CAD to the dnA-to-dnB call.
4. dnB makes a consult call to dnC.
5. dnC accepts the incoming call.

The dnB agent now has two calls — one *held* call (dnA-to-dnB) and one *connected* consult call (dnB-to-dnC). Data from the dnA-to-dnB call becomes available for the dnB-to-dnC call.

Up to this point the behavior of CAD is the same for 6.1 T-Gate and the *Gplus* Adapter 7. However, if you modify CAD on these two calls, the behavior will differ, as shown in the following steps.

6. Delete all CAD for the dnB-to-dnC call.

6.1 T-Gate behavior: CAD becomes *unavailable* for both calls (dnA-to-dnB and dnB-to-dnC).

The *Gplus Adapter 7* behavior: CAD is *deleted* for the dnB-to-dnC call, but is *still available* for the dnA-to-dnB call.

7. Insert some CAD to the dnB-to-dnC call.

6.1 T-Gate behavior: new CAD becomes *available* for both calls (dnA-to-dnB and dnB-to-dnC).

The *Gplus Adapter 7* behavior: new CAD is *available* for the dnB-to-dnC call, but is *still unavailable* for the dnA-to-dnB call.

8. Insert some CAD to the dnA-to-dnB call.

6.1 T-Gate behavior: updated CAD is *available* for the dnA-to-dnB call, but is *unavailable* for the dnB-to-dnC call.

The *Gplus Adapter 7* behavior: same as for 6.1 T-gate, updated CAD is *available* for the dnA-to-dnB call, but is *unavailable* for the dnB-to-dnC call.

9. dnB selects both calls and closes the conference.

6.1 T-Gate behavior: CAD from *held* dnA-to-dnB call becomes *available* for all conference parties.

The *Gplus Adapter 7* behavior: CAD from *connected* dnB-to-dnC call becomes *available* for all conference parties.

---

**Note:** You should take these differences into account when migrating to the *Gplus Adapter 7* for mySAP ERP from 6.1 T-Gate. For more details about how the *Gplus Adapter* handles CAD, see “Differences in Call-Attached Data Handling” on [page 1132](#), or the *Gplus Adapter 7 for mySAP ERP Deployment Guide* appendix.

---





## Chapter

# 66

## Changes in Configuration Options for the Gplus Adapter 7 for mySAP ERP

This section provides information to upgrade the configuration options of the *Gplus* Adapter 7 for mySAP ERP from the previous 6.1 T-Gate release. This section only discusses changes (additions, deletions, and modifications) in the product that need specifically to be addressed during the migration process.

For information about the new features and functions in the *Gplus* Adapter 7 for mySAP ERP, see the *Gplus Adapter 7 for mySAP ERP Getting Started Guide*.

This chapter contains:

- [Changes to Configuration Options for the Gplus Adapter, page 1138](#)

## Changes to Configuration Options for the Gplus Adapter

Table 198 explains the changes to the options for specific component(s) of the *Gplus* Adapter 7 for mySAP ERP.

**Table 198: Configuration Option Changes from 6.1 T-Gate to Gplus Adapter 7**

6.1 T-Gate Server Configuration Tab	6.1 T-Gate Configuration Option	Gplus Adapter 7 Option Section	Gplus Adapter 7 Configuration Option	Comments/Details
RFC Server Connection	R/3 Program ID	rfc-server	program-id	
	R/3 Gateway host	rfc-server	gateway-host	
	R/3 Gateway server	rfc-server	gateway-service	
	RFC Server start	N/A	N/A	The Adapter does not support RFC Server start.
	RFC traces	rfc-client	trace	The <i>Gplus</i> Adapter provides additional trace settings under the log section of configuration options.
RFC Server Pool	Begin RFC connections simultaneously	rfc-server	N/A	The <i>Gplus</i> Adapter uses a different thread pool model than T-Gate. See the <code>recv-thread</code> option in the <i>Gplus Adapter 7 for mySAP ERP Deployment Guide</i> .
	Additional reserve RFC connections	rfc-server	N/A	
	RFC Pool destruct timer (seconds)	N/A	N/A	The Adapter does not require this timer.

**Table 198: Configuration Option Changes from 6.1 T-Gate to Gplus Adapter 7 (Continued)**

6.1 T-Gate Server Configuration Tab	6.1 T-Gate Configuration Option	Gplus Adapter 7 Option Section	Gplus Adapter 7 Configuration Option	Comments/Details	
RFC Client Connection	R/3 Release	N/A	N/A	The Adapter does not require this option.	
	R/3 GUI Mode	N/A	N/A	The Adapter does not require this option.	
	R/3 Language	rfc-client	language		
	Application Host	rfc-client	ashost		
	R/3 System Number		rfc-client	sysnr	If no Load Balancing
			rfc-client	msserv	If using Load Balancing
	MS Host (only available if you choose to use Load Balancing)	rfc-client	mshost		
	R3Name (only available if you choose to use Load Balancing)	rfc-client	r3name		
Group (only available if you choose to use Load Balancing)	rfc-client	group			
RFC Client Account	R/3 Client	rfc-client	client		
	R/3 User	rfc-client	user		
	R/3 Password	rfc-client	password		
	R/3 Telephony Server	rfc-client	gateway-id		

**Table 198: Configuration Option Changes from 6.1 T-Gate to Gplus Adapter 7 (Continued)**

6.1 T-Gate Server Configuration Tab	6.1 T-Gate Configuration Option	Gplus Adapter 7 Option Section	Gplus Adapter 7 Configuration Option	Comments/Details
T-Gate General	Automatic extension registration, value = unchecked (0)	automatic-registration	auto-registration, value = none	
	Automatic extension registration, value = checked (1) Automatic registration of all extensions in the R/3 Telephony Server, value = selected (1)	automatic-registration	auto-registration, value = all	
	Automatic extension registration, value = checked (1) Automatic registration of active extensions in R/3 Telephony Server, value = selected (1)	automatic-registration	auto-registration, value = active	
	Registration update timer (seconds)	automatic-registration	register-timer	
	Un-registration update timer (seconds)	automatic-registration	deregister-timer	
	Notify incoming calls	rfc-client	notify	



**Table 198: Configuration Option Changes from 6.1 T-Gate to Gplus Adapter 7 (Continued)**

6.1 T-Gate Server Configuration Tab	6.1 T-Gate Configuration Option	Gplus Adapter 7 Option Section	Gplus Adapter 7 Configuration Option	Comments/Details
T-Server	T-Server Host	See Comments/Details	See Comments/Details	T-Server is defined in Genesys Configuration Manager on the Connections tab for the Adapter.
	T-Server TCP/IP Port	See Comments/Details	See Comments/Details	
	T-Server Username	See Comments/Details	See Comments/Details	
	T-Server Password	See Comments/Details	See Comments/Details	
Switch	Switch type	See Comments/Details	See Comments/Details	Switch type is based on the T-Server.
	Leading string inbound	call-number-translator	inbound-prefix	
	Leading string outbound	call-number-translator	outbound-prefix	
	Extension length	call-number-translator	extension-length	
	Specific configuration (Advanced button)	N/A	N/A	CTI driver handles this automatically.

**Table 198: Configuration Option Changes from 6.1 T-Gate to Gplus Adapter 7 (Continued)**

6.1 T-Gate Server Configuration Tab	6.1 T-Gate Configuration Option	Gplus Adapter 7 Option Section	Gplus Adapter 7 Configuration Option	Comments/Details
Optimization	Country code, Pre-code	call-number-translator	idd	The <i>Gplus</i> Adapter handles call optimization options in a different way than 6.1 T-Gate. You can find more information about call number optimization support of the Adapter in the configuration options under the <code>call-number-translator</code> section. See the <i>Gplus Adapter 7 for mySAP ERP Deployment Guide</i> for details.
	Country code, Value	call-number-translator	country-code	
	Area code, Pre-code	call-number-translator	ndd	
	Area code, Value	call-number-translator	area-code	
	Base number	call-number-translator	base-number	
	Incoming call optimization	call-number-translator	inbound-optimization	
	Outgoing call optimization	call-number-translator	outbound-optimization	

[Table 199](#) shows new configuration options available in the *Gplus* Adapter 7 for mySAP ERP.

**Table 199: New Configuration Options for the Gplus Adapter 7**

Gplus Adapter 7 Option Section	Gplus Adapter 7 Configuration Option	Comments/Details
rfc-client	type	= 3 for R/3
	trace	RFC Client trace
	codepage	The given codepage is to be used for this connection (default is 1100) or is set by the <code>SAP_CODEPAGE</code> environment variable). Useful if the SAP GUI is started with codepage other than 1100.
	retry-count	Resubmit Client requests.

**Table 199: New Configuration Options for the Gplus Adapter 7 (Continued)**

Gplus Adapter 7 Option Section	Gplus Adapter 7 Configuration Option	Comments/Details
rfc-server	listen-timeout	
	reconnect-timeout	
log	verbose	Specifies common Genesys log options. Additional options are described in the <i>Genesys Framework 7 Configuration Options Reference Manual</i> .
	segment	
	expire	
	buffering	
	all	
	print-attributes	
call-number-translator	outbound-remove	Hard-coded to ( )+ in T-Gate
	outbound-idd-substitute	Hard-coded to false in T-Gate
automatic-registration	register-on-demand	This is hard-coded to true in 6.1 T-Gate. It is now a configurable option in the <i>Gplus Adapter</i> .
telephony	blind-transfer	These options specify telephony settings. See the <i>Gplus Adapter 7 for mySAP ERP Deployment Guide</i> for details.  These functions were hard-coded in T-Gate, but are now configurable in the <i>Gplus Adapter</i> .
	sps-agentlogin-tout	
	sps-setworkmode-tout	
	sps-default-tout	
	sps-register-tout	
	workready-mapping	
	cti-log	

**Table 199: New Configuration Options for the Gplus Adapter 7 (Continued)**

Gplus Adapter 7 Option Section	Gplus Adapter 7 Configuration Option	Comments/Details
genmodel	enable-log-user-data	These options control the switch abstraction layer - CTI driver (genmodel) behavior. See the <i>Gplus Adapter 7 for mySAP ERP Deployment Guide</i> for details.  These functions were hard-coded in T-Gate, but are now configurable in the <i>Gplus Adapter</i> .
	answer-call-delay	
	release-call-on-auto-logout	
	agent-substitute	
	agent-logout-control	
	request-timeout	
	use-pending-workmode	
	delete-call-timeout	
call attached data	cic-clipboard	Specifies options for Call Attached Data. See the <i>Gplus Adapter 7 for mySAP ERP Deployment Guide</i> for details.  These functions were hard-coded in T-Gate, but are now configurable in the <i>Gplus Adapter</i> .
	keyvalue	
	custom	
	logsys-option	
	logsys-value	



## Chapter

# 67

## Migration Procedures

This chapter discusses the migration procedures for release 6.1 of T-Gate to the *Gplus* Adapter 7 for mySAP ERP.

This chapter contains:

- [Migration of 6.1 T-Gate to the Gplus Adapter 7 for mySAP ERP, page 1145](#)

---

## Migration of 6.1 T-Gate to the Gplus Adapter 7 for mySAP ERP

The migration procedures for release 6.1 of T-Gate to the *Gplus* Adapter 7 for mySAP ERP are discussed in this section.

---

**Note:** Upgrade Genesys Framework and other prerequisite Genesys components, if necessary, as described in the Step 1 of “Migration and Upgrade Order” on [page 1130](#).

---

Follow these migration procedures to move 6.1 T-Gate settings to the *Gplus* Adapter 7 for mySAP ERP settings:

1. Update Contact Center configuration in Genesys Configuration Manager as needed.
  - a. Migrate Multiple DN Configuration  
For each multi-DN teleaset configuration, create a Place object in Genesys Configuration Manager which contains the corresponding ACD Position and Extension links. See “Configuring Places for T-Gate Multi-DN Telesets” on [page 1147](#).
  - b. Migrate Queue Configuration

You need to create Person and Agent Group objects in Genesys Configuration Manager to enable Contact Center functionality. See “Migrating Queue Configuration” on [page 1149](#).

**2. Migrate Server Configuration and Configuration profiles.**

6.1 T-Gate Configuration Manager supports multiple configuration profiles which correspond to Application Objects in Genesys Configuration Manager. For each profile configured in T-Gate Configuration Manager, you should create a separate Application Object in Genesys Configuration Manager, and move all options appropriately. In 6.1 T-Gate, you should activate the profile from the T-Gate Configuration Manager to start the execution thread. With Genesys, however, you start a separate instance of the *Gplus* Adapter.

So, to migrate Server Configuration and Configuration profiles, you will need to:

- a. Create a Host Object in Genesys Configuration Manager.
- b. Import the Application template for the *Gplus* Adapter 7 for mySAP ERP.
- c. Create and configure an Application Object in Genesys Configuration Manager for each Configuration profile from 6.1 T-Gate.
- d. Install a separate Adapter instance for each Application Object in Configuration Manager. On startup, the *Gplus* Adapter reads its settings from the appropriate Application Object.

See “Installing the *Gplus* Adapter,” in the *Gplus Adapter 7 for mySAP ERP Deployment Guide* for instructions to help you with the steps above.

**3. Migrate 6.1 T-Gate configuration options to the *Gplus* Adapter 7 for mySAP ERP configuration options.**

Use [Table 198](#), “Configuration Option Changes from 6.1 T-Gate to *Gplus* Adapter 7,” on [page 1138](#), and “Configuring the *Gplus* Adapter,” in the *Gplus Adapter 7 for mySAP ERP Deployment Guide* to gather the information you need to do this.

**4. Set up new configuration options that are available in the *Gplus* Adapter 7 for mySAP ERP, but were not available in 6.1 T-Gate.**

See [Table 199](#), “New Configuration Options for the *Gplus* Adapter 7,” on [page 1142](#). Also see “Configuring the *Gplus* Adapter,” in the *Gplus Adapter 7 for mySAP ERP Deployment Guide* for full descriptions of these options. Take note of any configuration options that you must set for the Adapter to function properly. You may accept the default settings on all other options.

**5. Migrate routing strategies, if applicable.**

## Configuring Places for T-Gate Multi-DN Telesets

As for 6.1 T-Gate, you should configure only one (primary) DN in SAP so that the SAP configuration does not need to be changed. On the Genesys side, you should define a Place object containing all Telesets' DNs (ACD Positions and Extensions) as follows:

1. Start and log in to Genesys Configuration Manager.
2. Select the Places folder under Resources.
3. Select File > New > Place.

The New Place dialog box opens as shown in Figure 57 on [page 1147](#).

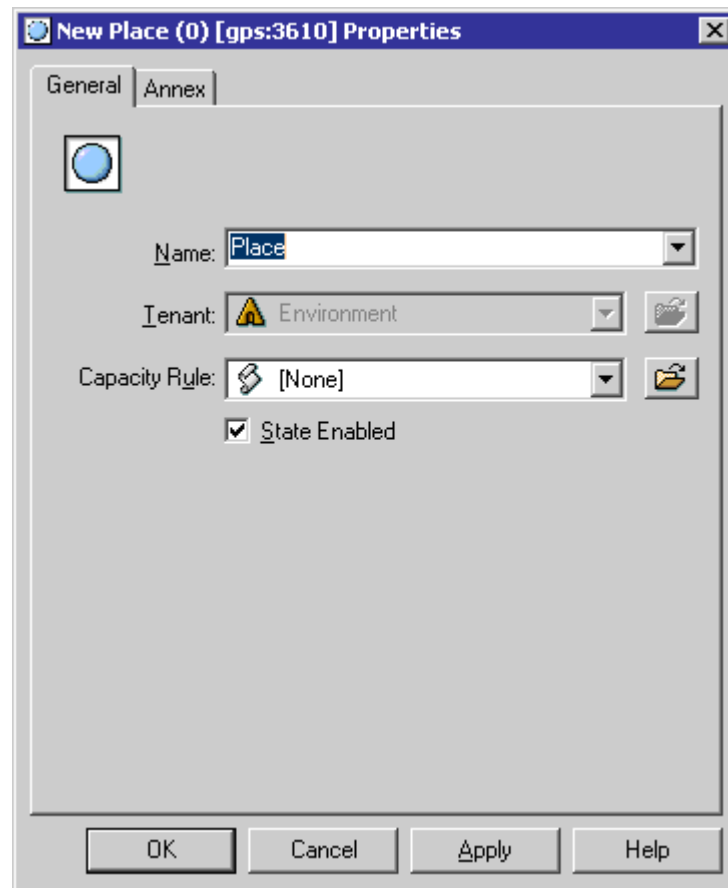

**Figure 57: New Place Dialog Box**

4. Enter a unique name in the Name field and click OK.
5. In Configuration Manager, double-click the created Place object to open it.
6. Select File > New > Shortcut to DN.

The Browse DN dialog box opens as shown in [Figure 58](#).

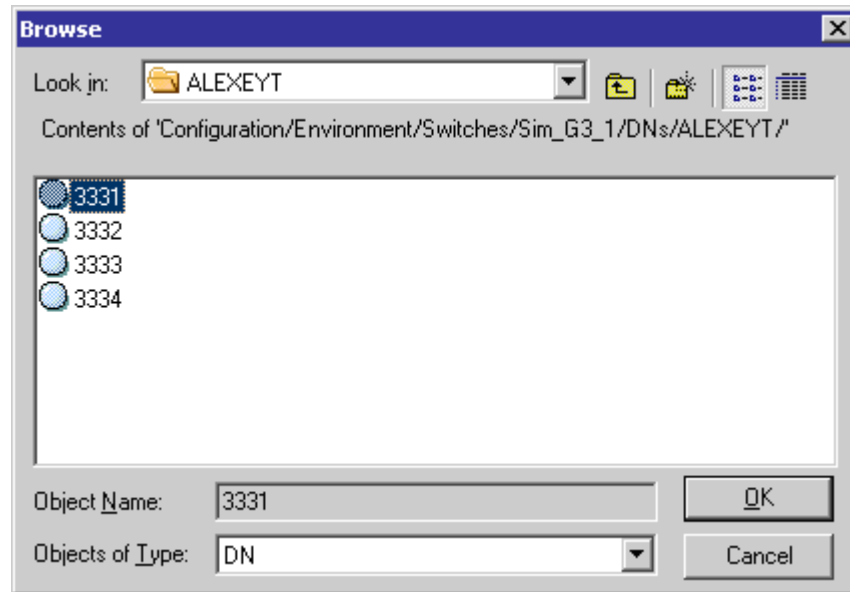

**Figure 58: Browse DN**

7. Select ACD positions and or extensions to be added for this teleset (you can do multiple selection using the Ctrl key and mouse), then click OK.
8. Verify that the created Place contains correct extensions and positions. For details about extensions and ACD positions please see the T-Server and Switch vendor documentation.

In example shown in Figure 59 on [page 1149](#), if SAP defines 3331 as an extension, it will ask to register the extension, and the Adapter will actually register *two* DNs: ACD position 3431 and Extension 3331.



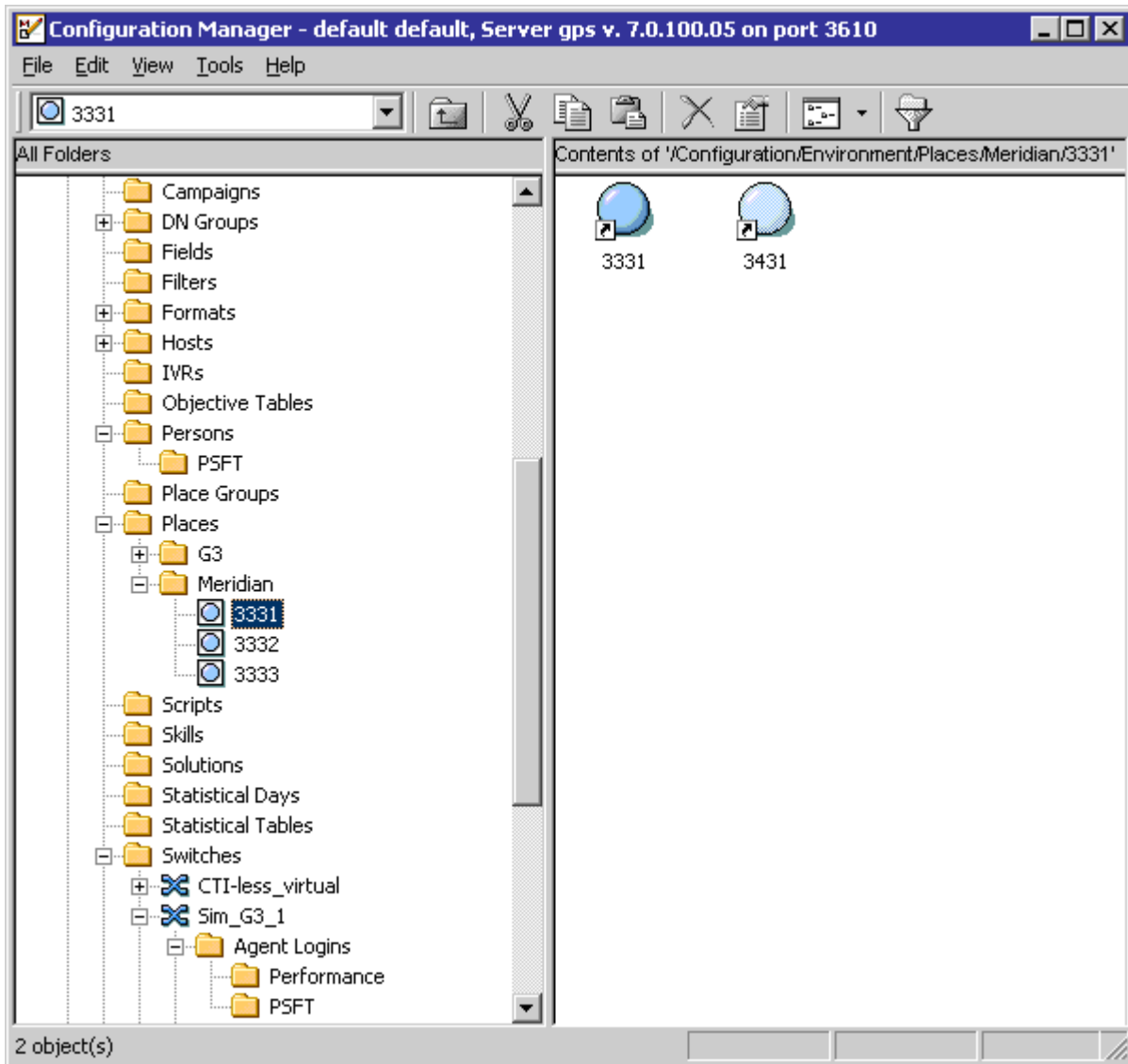

Figure 59: Mapping of SAP Extension to Genesys DNs

## Migrating Queue Configuration

To define Queues available to log into, you need to complete the following steps:

1. Start and log in to Genesys Configuration Manager.
2. Select the Persons folder under Resources.
3. Select File > New > Person.

The New Person dialog box opens as shown in Figure 60 on [page 1150](#).

The image shows a Windows-style dialog box titled "New Person (0) [gps:3610] Properties". It has four tabs: "General", "Agent Info", "Ranks", and "Annex". The "General" tab is active. On the left, there is a small green person icon. The main area contains several input fields and checkboxes:

- Name:** A group box containing two dropdown menus: "First" with the value "John" and "Last" with the value "Smith".
- Tenant:** A dropdown menu showing "Environment" with a warning icon to its left and a refresh icon to its right.
- Employee ID:** A text input field containing "111".
- User Name:** A dropdown menu containing "Smith, John".
- Enter Password:** An empty text input field.
- Re-enter Password:** An empty text input field.
- State Enabled:** A checked checkbox.
- Is Agent:** A checked checkbox.

At the bottom of the dialog box are four buttons: "OK", "Cancel", "Apply", and "Help".

**Figure 60: New Person Dialog Box**

4. On the **General** tab, enter the person's name in the **First** and **Last Name** fields.
5. Enter a unique user name in the **User Name** field.
6. Select the **Agent Info** tab.
7. Select one of the previously created places as the **Default** place as shown in Figure 61 on [page 1151](#) and click **OK**.

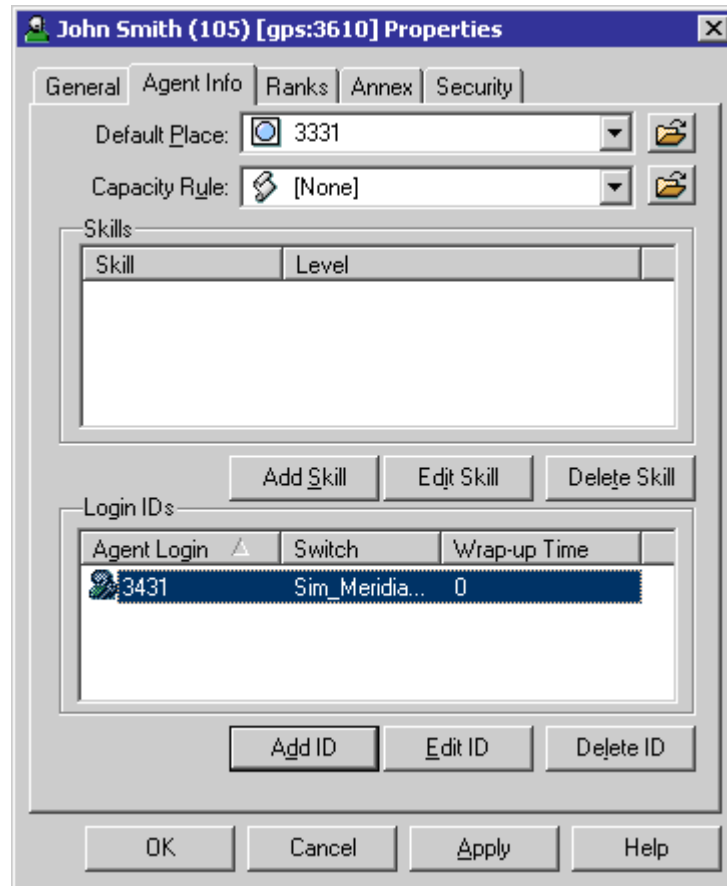

**Figure 61: Agent Info Tab**

8. Repeat Steps 3 through 7 for each person/place.
9. In Configuration Manager, select the Agent Groups folder under Resources.
10. Select File > New > Agent Group.

The New Agent Group dialog box opens as shown in Figure 62 on [page 1152](#).

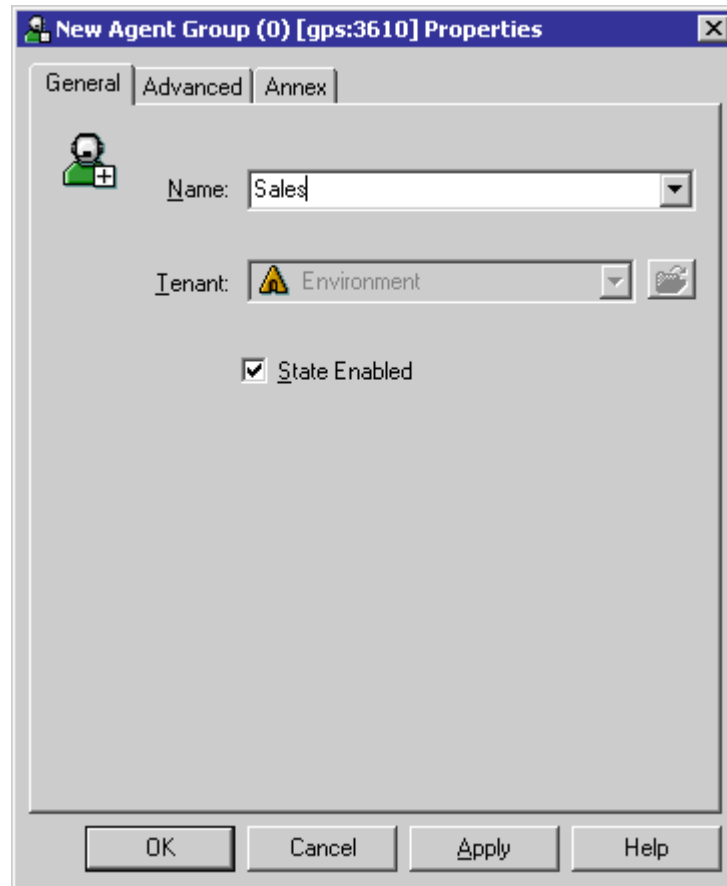

**Figure 62: New Agent Group Dialog Box**

11. On the General tab, enter a unique agent group name in the Name field.
12. Select the Advanced tab.
13. Add available Queues to the list of Origination DNs as shown in Figure 63 on [page 1153](#) and click OK.

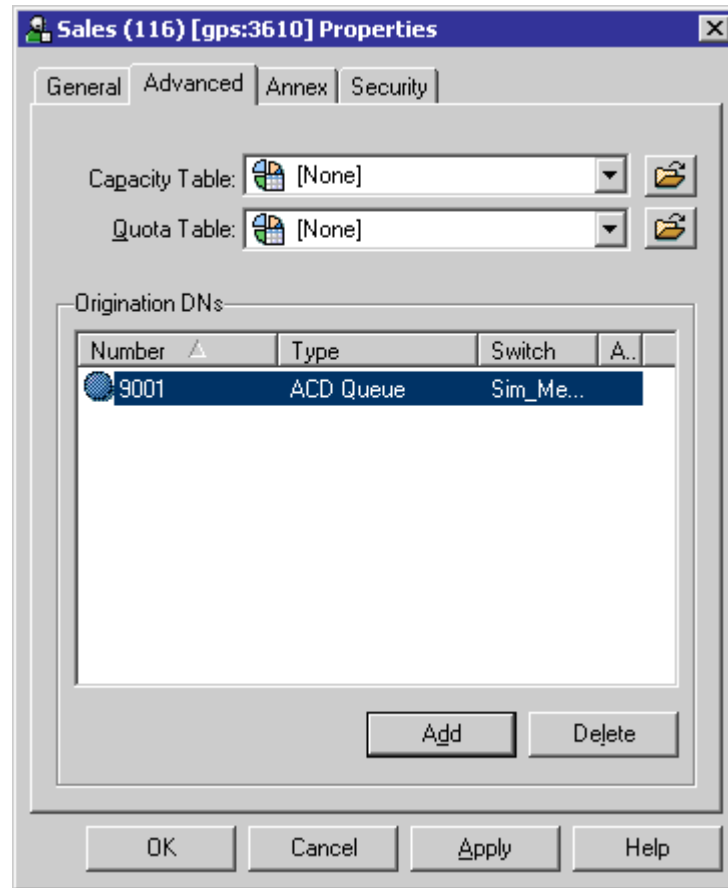

**Figure 63: Advanced Tab**

14. In Configuration Manager, double-click the created Agent Group object to open it.
15. Select **File > New > Shortcut to Agent**.  
The Browse dialog box opens.





**Part**

# 21

## **The Gplus Adapter for Siebel CRM Migration**

This section describes the preliminary migration procedures and the migration order for the *Gplus* Adapter for Siebel CRM. It contains the following chapters:

- Chapter 68, “Introduction to the Gplus Adapter for Siebel CRM Migration,” on page 1157 discusses the preliminary migration procedures and the migration order for migrating from version 6.5.2 to 7.0, from version 7.0 to 7.1, from version 7.1 to 7.2, and from 7.2 to 7.5.
- Chapter 69, “Changes in Gplus Adapter for Siebel CRM,” on page 1161 discusses changes (additions, deletions, and modifications) in the product that need to be addressed during the migration process.
- Chapter 70, “Migration Procedures,” on page 1167 discusses the migration procedures for 6.x to 7.0 migration, for 7.0 to 7.1 migration, for 7.1 to 7.2 migration, and for 7.2 to 7.5 migration.







## Chapter

# 68

## Introduction to the Gplus Adapter for Siebel CRM Migration

This chapter discusses the preliminary migration procedures and the migration order for migrating from version 6.5.2 to 7.0, from version 7.0 to 7.1, from version 7.1 to 7.2, and from version 7.2 to 7.5.

There is one main section in this chapter:

- [Preliminary Migration Procedures, page 1157](#)

---

## Preliminary Migration Procedures

---

**Note:** If you want to upgrade your operating system before the migration of your Genesys product, contact Professional Services.

---

The migration process includes these preliminary procedures for the *Gplus* Adapter for Siebel CRM:

1. Review Chapter 1, “Migration Roadmap,” on [page 35](#) of this guide.
2. Examine the component changes for the *Gplus* Adapter in the next chapter, Chapter 69, “Changes in Gplus Adapter for Siebel CRM,” on [page 1161](#) under the heading, “Component Changes for the Gplus Adapter for Siebel CRM” on [page 1162](#).

---

**Notes:**

- Please note that these tables only discuss changes that directly affect the migration of this product.

- For complete information about “What’s New in This Release” of the *Gplus* Adapter 7 for Siebel 7 and how the 7.0 version functions, please see the current product’s User Guide.
  - For complete information about “What’s New in This Release” of the *Gplus* Adapter 7.1 for Siebel 7 and how the 7.1 version functions, please see the current product’s User Guide.
  - For complete information about “What’s New in This Release” of the *Gplus* Adapter 7.2 for Siebel CRM and how the 7.2 version functions, please see the current product’s User Guide.
  - For complete information about “What’s New in This Release” of the *Gplus* Adapter 7.5 for Siebel CRM and how the 7.5 version functions, please see the current product’s User Guide.
  - For a complete list of documentation relevant to the migration of this product, see “[Reference Materials](#)”.
- 

3. Other Genesys products (T-Servers, and so on) required by the Adapter must be properly licensed. Review the licensing requirements for the Genesys products. See Chapter 2, “Licensing Migration,” on [page 41](#) in this guide.
4. See the *Genesys Licensing Guide* for more information about Licensing.
5. See the *Genesys 7 Interoperability Guide* and the *Genesys 8 Interoperability Guide* for information on the compatibility of Genesys products with various Configuration Layer Environments; Interoperability of Reporting Templates and Solutions; and *Gplus* Adapters Interoperability.

## Reference Materials

- *Genesys Licensing Guide*
- *Genesys 7 Interoperability Guide*
- *Genesys 8 Interoperability Guide*

For version 7.0 of the Adapter:

- *Gplus Adapter 7 for Siebel 7 User’s Guide*
- *Gplus Adapter 7 for Siebel 7 Deployment Guide*
- *Gplus Adapter 7 for Siebel 7 Developer’s Guide*

For version 7.1 of the Adapter:

- *Gplus Adapter 7.1 for Siebel 7 User’s Guide*
- *Gplus Adapter 7.1 for Siebel 7 Deployment Guide*
- *Gplus Adapter 7.1 for Siebel 7 Developer’s Guide*

For version 7.2 of the Adapter:

- *Gplus Adapter 7.2 for Siebel CRM User's Guide*
- *Gplus Adapter 7.2 for Siebel CRM Deployment Guide*
- *Gplus Adapter 7.2 for Siebel CRM Developer's Guide*

For version 7.5 of the Adapter:

- *Gplus Adapter 7.5 for Siebel CRM User's Guide*
- *Gplus Adapter 7.5 for Siebel CRM Deployment Guide*
- *Gplus Adapter 7.5 for Siebel CRM Developer's Guide*





## Chapter

# 69

## Changes in Gplus Adapter for Siebel CRM

This section provides information to upgrade the components and configuration options of the *Gplus* Adapter for Siebel CRM from release 6.5.2 to 7.0, from release 7.0 to 7.1, from release 7.1 to 7.2, and from release 7.2 to 7.5. This section only discusses changes (additions, deletions, and modifications) in the product that need to be addressed during the migration process.

The following documents for the 7.0 release contain a comprehensive list of changes from 6.5.2 to 7.0:

- *Gplus Adapter 7 for Siebel 7 User's Guide*
- *Gplus Adapter 7 for Siebel 7 Deployment Guide*
- *Gplus Adapter 7 for Siebel 7 Developer's Guide*
- *70gp\_supp\_sl7.html*

The following documents for the 7.1 release contain a comprehensive list of changes from 7.0 to 7.1:

- *Gplus Adapter 7.1 for Siebel 7 User's Guide*
- *Gplus Adapter 7.1 for Siebel 7 Deployment Guide*
- *Gplus Adapter 7.1 for Siebel 7 Developer's Guide*
- *71gp\_supp\_sl7.html*

The following documents for the 7.2 release contain a comprehensive list of changes from 7.1 to 7.2:

- *Gplus Adapter 7.2 for Siebel CRM User's Guide*
- *Gplus Adapter 7.2 for Siebel CRM Deployment Guide*
- *Gplus Adapter 7.2 for Siebel CRM Developer's Guide*
- *72gp\_supp\_slcrm.html*

The following documents for the 7.5 release contain a comprehensive list of changes from 7.2 to 7.5:

- *Gplus Adapter 7.5 for Siebel CRM User's Guide*
- *Gplus Adapter 7.5 for Siebel CRM Deployment Guide*
- *Gplus Adapter 7.5 for Siebel CRM Developer's Guide*
- *75gp\_supp\_slcrm.html*

The sections in this chapter are:

- [Component Changes for the Gplus Adapter for Siebel CRM, page 1162](#)
- [Changes to the Configuration Options, page 1165](#)
- [Architectural Changes, page 1166](#)

---

## Component Changes for the Gplus Adapter for Siebel CRM

**Table 200** lists the elements of the *Gplus* Adapter for Siebel 7 that changed from version 6.5.2 to 7.0. This table maps 6.5.2 names to 7.0/7.1 names and provides useful guidance to those who must migrate from the 6.5.2 version to the 7.0 version.

For information about all the new features and functions in the *Gplus* Adapter for Siebel 7, see the *Gplus Adapter 7 for Siebel 7 User's Guide*, or the *Gplus Adapter 7.1 for Siebel 7 User's Guide*.

**Table 200: Configuration Changes from 6.5.2 Maintenance Release to 7.0/7.1**

6.5.2 Configuration Component/ Feature	7.0/7.1 Configuration Component/ Feature	Comments/Details
Configuration Component	Configuration Synchronization Component	Name change implements a more descriptive component name.
Outbound Server Component	Campaign Synchronization Component	Name change implements a more descriptive component name. Note: The Outbound Contact Server (OCS) is a separate Genesys product that supports this <i>Gplus</i> Adapter component.

**Table 201** lists the elements of the *Gplus* Adapter for Siebel CRM that changed from version 7.1 to 7.2. This table maps 7.1 terms to 7.2 terms and provides useful guidance to those who must migrate from the 7.1 version to the 7.2 version.

**Table 201: Configuration Component Changes from Version 7.1 to Version 7.2**

7.1 Configuration Component/ Feature	7.2 Configuration Component/ Feature	Comments/Details
<i>Gplus</i> Adapter for Siebel 7 Voice.	<i>Gplus</i> Adapter for Siebel CRM Voice.	Name changed.
<i>Gplus</i> Adapter for Siebel 7 Configuration Synchronization.	<i>Gplus</i> Adapter for Siebel CRM Configuration Synchronization.	Name changed.
<i>Gplus</i> Adapter for Siebel 7 Campaign Synchronization.	<i>Gplus</i> Adapter for Siebel CRM Campaign Synchronization.	Name changed.
<i>Gplus</i> Adapter for Siebel 7 Siebel eMail.	<i>Gplus</i> Media Routing for Siebel CRM.	Name changed to reflect the additional routing functionality and ability to interact with any media item and not just to Siebel eMail.
<i>Gplus</i> Adapter for Siebel 7 Multimedia.		Component removed and replaced by <i>Gplus</i> Adapter for Siebel CRM Multimedia and <i>Gplus</i> UCS Gateway for Siebel CRM.
	<i>Gplus</i> Adapter for Siebel CRM Multimedia.	New component.

**Table 201: Configuration Component Changes from Version 7.1 to Version 7.2 (Continued)**

7.1 Configuration Component/ Feature	7.2 Configuration Component/ Feature	Comments/Details
	<i>Gplus</i> Communication Server for Siebel CRM.	New component.
	<i>Gplus</i> UCS Gateway for Siebel CRM.	New component.

For information about all the new features and functions in the *Gplus* Adapter for Siebel CRM, see the current product's Deployment Guide.

[Table 202](#) lists the elements of the *Gplus* Adapter for Siebel CRM that changed from version 7.2 to 7.5. This table maps 7.2 terms to 7.5 terms and provides useful guidance to those who must migrate from the 7.2 version to the 7.5 version.

**Table 202: Configuration Component Changes from Version 7.2 to Version 7.5**

7.2 Configuration Component/ Feature	7.5 Configuration Component/ Feature	Comments/Details
<i>Gplus</i> Adapter for Siebel CRM Voice.	<i>Gplus</i> Adapter for Siebel CRM Voice.	No changes
<i>Gplus</i> Adapter for Siebel CRM Configuration Synchronization.	<i>Gplus</i> Adapter for Siebel CRM Configuration Synchronization.	No changes
<i>Gplus</i> Adapter for Siebel CRM Campaign Synchronization.	<i>Gplus</i> Adapter for Siebel CRM Campaign Synchronization.	No changes
<i>Gplus</i> Media Routing for Siebel CRM.	<i>Gplus</i> Media Routing for Siebel CRM.	No changes
<i>Gplus</i> Adapter for Siebel CRM Multimedia.	<i>Gplus</i> Adapter for Siebel CRM Multimedia.	No changes
<i>Gplus</i> Communication Server for Siebel CRM.	<i>Gplus</i> Communication Server for Siebel CRM.	No changes
<i>Gplus</i> UCS Gateway for Siebel CRM.	<i>Gplus</i> UCS Gateway for Siebel CRM.	No changes



For information about all the new features and functions in the *Gplus* Adapter for Siebel CRM, see the current product's Deployment Guide.

---

## Changes to the Configuration Options

The configuration options for specific components of the *Gplus* Adapter for Siebel CRM are described in full detail in the current product's Deployment Guide.

- For changes to the configuration options when migrating from release 6.5.2 to 7.0, refer also to the HTML file (*70gp\_supp\_sl7.html*) that supplements this *Gplus* Adapter migration section in this guide. This HTML file is supplied with the *Gplus* Adapter distribution DVD for release 7.0.
- For changes to the configuration options when migrating from release 7.0 to 7.1, refer also to the HTML file (*71gp\_supp\_sl7.html*) that supplements this *Gplus* Adapter migration section in this guide. This HTML file is supplied with the *Gplus* Adapter distribution DVD for release 7.1.
- For changes to the configuration options when migrating from release 7.1 to 7.2, refer also to the HTML file (*72gp\_supp\_slcrm.html*) that supplements this *Gplus* Adapter migration section in this guide. This HTML file is supplied with the *Gplus* Adapter distribution DVD for release 7.2.
- For changes to the configuration options when migrating from release 7.2 to 7.5, refer also to the HTML file (*75gp\_supp\_slcrm.html*) that supplements this *Gplus* Adapter migration section in this guide. This HTML file is supplied with the *Gplus* Adapter distribution DVD for release 7.5.

## Architectural Changes

The architecture of the 7.2 driver components was significantly changed from that of the 7.1 components.

- In version 7.1 and earlier, the Siebel Communication Server loads and starts the *Gplus* Adapter.

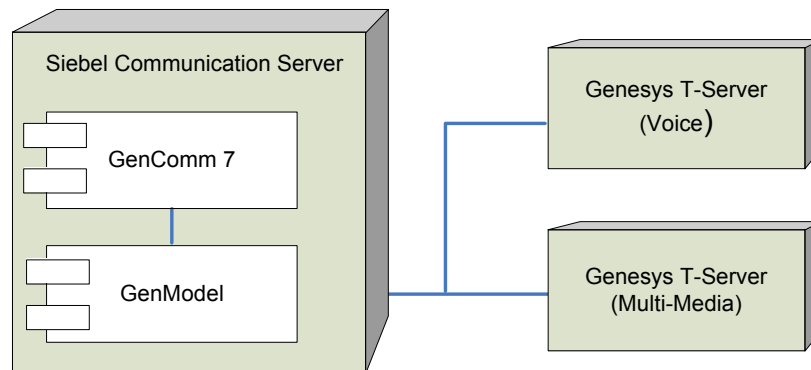

**Figure 64: Overview of 7.1 Driver Components' Architecture**

- In version 7.2, the Genesys Communication Server (GenCommSrvr) runs the *Gplus* Adapter implementation libraries (GenComm7 and GenModel). The implementation libraries are installed in the GenCommServ folder. The Siebel Communication Server interacts with the *Gplus* Adapter through the Genesys Communication Driver (GenCommDrv) dynamic library.

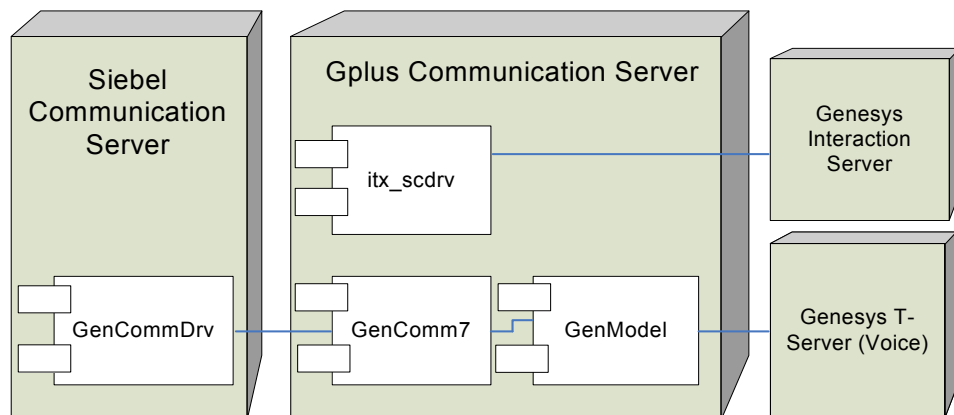

**Figure 65: Overview of 7.2 Driver Components' Architecture**



## Chapter

# 70

## Migration Procedures

This chapter discusses the migration procedures for release 6.x to 7.0 migration, for release 7.0 to 7.1 migration, for release 7.1 to 7.2 migration, and for release 7.2 to 7.5 migration.

The sections in this chapter are:

- [Migration Procedures for the Gplus Adapter for Siebel CRM, page 1167](#)
- [Prerequisite Migration for the Gplus Adapter for Siebel CRM, page 1168](#)
- [Migration Procedures, page 1169](#)
- [Upgrading a Customized GenComm7\\_universal.def or GenComm\\_universal.def File, page 1172](#)

---

## Migration Procedures for the Gplus Adapter for Siebel CRM

### Siebel CRM 6.5.2 to 7.0; 7.0 to 7.1; 7.1 to 7.2; or 7.2 to 7.5

The migration procedures for the *Gplus* Adapter for Siebel CRM from 6.5.2 to 7.0; from 7.0 to 7.1; from 7.1 to 7.2; or from 7.2 to 7.5 are discussed in this section.

Prior to Adapter migration, you must complete the migration of all systems required for this new version of the Adapter, including any related licensing procedures. This is explained below under the heading, “Prerequisite Migration for the Gplus Adapter for Siebel CRM” on [page 1168](#).

The migration of the *Gplus* Adapter for Siebel CRM version 6.5.2 to 7.0; from 7.0 to 7.1; from 7.1 to 7.2; or from 7.2 to 7.5 is not complicated in itself. To summarize, you uninstall the previous version of the Adapter and install the new version according to the instructions in the current product’s Deployment

Guide. The part of the migration process that is harder to address is the replication of existing customizations to the existing *Gplus* Adapter.

Customizations of the Siebel and *Gplus* Adapter products can take many forms, so it is impossible to provide specific instructions for re-implementing the particular customizations that your organization has performed.

However, this section does describe methods that may help migrate some customization work.

---

## Prerequisite Migration for the Gplus Adapter for Siebel CRM

Complete these preliminary procedures before starting your migration of the *Gplus* Adapter for Siebel CRM:

1. License the Genesys products required to support your implementation of the *Gplus* Adapter for Siebel CRM.

Licensing is addressed in these documents:

- *Genesys Licensing Guide*
- Chapter 2, “Licensing Migration,” on [page 41](#) of this guide

2. Migration of Framework 6.5 to 7.0, 7.0 to 7.1, 7.1 to 7.2, or 7.2 to 7.5, as necessary.

See the first chapter about migrating the *Gplus* Adapter, Chapter 68, “Introduction to the *Gplus* Adapter for Siebel CRM Migration,” on [page 1157](#).

3. Upgrading other products (including Genesys products) that are required for your implementation of the *Gplus* Adapter.

The *Gplus* Adapter system requirements for other Genesys products will vary depending on the *Gplus* Adapter components and features that you intend to install. Refer to the system requirements documentation in the *Gplus Adapter for Siebel CRM Deployment Guide* and to the product’s Release Advisory.

---

# Migration Procedures

When all the prerequisites for migration of the *Gplus* Adapter for Siebel CRM are all in place, the fundamental migration process will include the following phases:

- Backup of all previous version files
- Modifying the definition (.def) file for the migration
- Identifying customizations other than those in the .def file
- Uninstalling the previous version
- Installing the new version with the migrated .def file
- Re-implementing customizations during or after installation of the *Gplus* Adapter for Siebel CRM.

---

**Note:** Because customizations of the Siebel and the *Gplus* Adapter products can take many and varied forms, it is impossible for Genesys Laboratories to provide specific instructions for re-implementing all of your existing customizations of these products on your new version of the Adapter.

Chapter 70 on [page 1167](#) provides some fundamental information about migrating the *Gplus* Adapter for Siebel 7 from version 6.5.2 to 7.0, from version 7.0 to 7.1, from version 7.1 to 7.2, and from version 7.2 to 7.5, and includes examples of methods used to preserve some customizations. However, these examples are provided as an aid; they are not intended as a comprehensive guide. Ultimately, you are responsible for re-implementing all customizations.

---

The migration procedures below assume that your organization has made modifications to customize the standard Siebel and the *Gplus* Adapter packages, and that you wish to see these customizations implemented in your upgraded versions. In some cases, new features and options available in the 7.0, 7.1, 7.2, or 7.5 release of the Adapter will supersede related capabilities available in your earlier version, and you will want to replace it with the new, standard *Gplus* Adapter feature.

Although it is impossible to automate the migration of all such customizations, this document does provide help with the migration of customizations implemented in the `GenComm_universal.def` file (the `.def` file). Modifications to the driver-based components of the *Gplus* Adapter for Siebel CRM typically involve changes to this file.

---

**Note:** In versions 6.5.2 through 7.2 of the Adapter, the file is called `GenComm7_universal.def`. In version 7.5 of the Adapter, the file is called `GenComm_universal.def`.

---

Before starting the migration process, familiarize yourself with the HTML documents named `70gp_supp_sl7.html`, `71gp_supp_sl7.html`, `72gp_supp_slcrm.html`, or `75gp_supp_slcrm.html`, depending on whether you are migrating from 6.5.2 to 7.0, from 7.0 to 7.1, from 7.1 to 7.2, or from 7.2 to 7.5.

- The document named `70gp_supp_sl7.html` indicates the differences between the *Gplus* Adapter's standard 7.0 and 6.5.2 versions of the `.def` file.
- The document named `71gp_supp_sl7.html` indicates the differences between the *Gplus* Adapter's standard 7.1 and 7.0 versions of the `.def` file.
- The document named `72gp_supp_slcrm.html` indicates the differences between the *Gplus* Adapter's standard 7.1 and 7.2 versions of the `.def` file.
- The document named `75gp_supp_slcrm.html` indicates the differences between the *Gplus* Adapter's standard 7.2 and 7.5 versions of the `.def` file.

If you want to migrate any of the customizations implemented in the `GenComm7_universal.def` or `GenComm_universal.def` file, you will need to use the appropriate HTML file for your migration.

Genesys does not support any customizations to the Configuration Synchronization Component, so you must perform any modifications to this server-based component on your own.

---

**Note:** Throughout the documentation for the *Gplus* Adapter for Siebel CRM, the Voice, Siebel E-mail (Media Routing), and Multimedia components of the Adapter are identified as the "driver-based components," and the Configuration Synchronization, Campaign Synchronization, Communication Server and UCS Gateway components of the Adapter are identified as the "server-based components."

---

Perform these migration procedures:

1. Review the HTML document `70gp_supp_sl7.html`, `71gp_supp_sl7.html`, `72gp_supp_slcrm.html`, or `75gp_supp_slcrm.html` as appropriate to your migration.
2. Perform updates:
  - If migrating from 6.5.2, update your 6.5.2 version of the *Gplus* Adapter to the latest maintenance release, as necessary.
  - If migrating from 7.0, update your 7.0 version of the *Gplus* Adapter to the latest maintenance release, as necessary.
  - If migrating from 7.1, update your 7.1 version of the *Gplus* Adapter to the latest maintenance release, as necessary.
  - If migrating from 7.2, update your 7.2 version of the *Gplus* Adapter to the latest maintenance release, as necessary.

3. Back up all files for your previous implementation of the *Gplus* Adapter for Siebel CRM (6.5.2, 7.0, 7.1, or 7.2).
4. Make an extra copy of the `GenComm_universal.def` file for the migration.
5. Update your `GenComm_universal.def` file (or `GenComm7_universal.def` if you are migrating to version 7.0, 7.1, or 7.2 of the Adapter).  
Use the more detailed procedures documented below, under the heading “Upgrading a Customized `GenComm7_universal.def` or `GenComm_universal.def` File” on [page 1172](#), to preserve customizations implemented in this file while updating it for use in the deployment of the *Gplus* Adapter for Siebel CRM. Save copies of the resulting `.def` file.
6. Identify customizations made in any additional components other than the `.def` file. For example, identify any customizations made to the Campaign Synchronization Component (known as the Outbound Contact Component in version 6.5.2 of the *Gplus* Adapter).
7. Uninstall the previous version of the *Gplus* Adapter for Siebel 7 (6.5.2, 7.0, 7.1, or 7.2).  
Apply the uninstallation instructions in the *6.5 Gplus Adapter for Siebel 7 Deployment Guide*, *Gplus Adapter 7 for Siebel 7 Deployment Guide*, *Gplus Adapter 7.1 for Siebel 7 Deployment Guide*, or the *Gplus Adapter 7.2 for Siebel 7 Deployment Guide*, but do not make any configuration changes.
8. Install the 7.0, 7.1, or 7.2 version of *Gplus* Adapter for Siebel CRM with the updated `.def` file (see Step 5 above). Or, install the 7.5 version of the *Gplus* Adapter for Siebel CRM, as described by the installation procedures in the *Gplus Adapter 7.5 for Siebel CRM Deployment Guide* with the updated `.def` file (see Step 5 above).
9. Re-implement customizations during or after installation of the *Gplus* Adapter for Siebel CRM.

---

**Note:** When migrating Multimedia and/or Media Routing components to the 7.2 or 7.5 version, it is necessary to add a pseudo extension `<teleset-name>@GP` and to remove old multimedia DNs (extensions with `@GE`, `@GC` and `@SE` aliases) for all telesets used for Siebel eMail and/or Genesys multimedia interactions. This change is necessary because Genesys Multimedia (formerly known as Genesys Multi Channel Routing [MCR] Solution) solution uses `place` as an endpoint for e-mail, chat and other (open media) interactions, while ICS uses chat and e-mail DNs.

---

10. Test.

---

# Upgrading a Customized GenComm7\_universal.def or GenComm\_universal.def File

Modifications to the configuration of driver-based components of the *Gplus* Adapter for Siebel CRM typically involve changes to the GenComm\_universal.def file (or GenComm7\_universal.def in versions 7.0, 7.1, and 7.2). By migrating the customizations you have made in your 6.5.2, 7.0, 7.1, or 7.2 GenComm7\_universal.def file to the 7.5 GenComm\_universal.def file, you can maintain your customizations (assuming other conditions remain the same).

The HTML document containing the text of the standard GenComm7\_universal.def for the *Gplus* Adapter for Siebel CRM is included on the distribution DVD for the 7.0, 7.1, and 7.2 releases.

The HTML document containing the text of the standard GenComm\_universal.def file for the *Gplus* Adapter for Siebel CRM is included on the distribution DVD for the 7.5 release.

## For 6.5.2 to 7.0 differences:

The HTML file that documents the differences between the standard 7.0 .def file and the 6.5.2 version of the .def file is called 70gp\_supp\_sl7.html:

(<http://genesyslab.com/support/dl/retrieve/default.asp?item=B5C334AA30A63CA2389E04748AF60279&view=item>).

## For 7.0 to 7.1 differences:

The HTML file that documents the differences between the standard 7.1 .def file and the 7.0 version of the .def file is called 71gp\_supp\_sl7.html:

(<http://genesyslab.com/support/dl/retrieve/default.asp?item=B1BBC8CACCCED0C2D4C6D8254BB5BAC7&view=item>).

## For 7.1 to 7.2 differences:

The HTML file that documents the differences between the standard 7.2 .def file and the 7.1 version of the .def file is called 72gp\_supp\_slcrm.htm.

(<http://genesyslab.com/support/dl/retrieve/default.asp?item=B4C131A63BA035AA2FB42957ACD92A5A&view=item>).



**For 7.2 to 7.5 differences:**

The HTML file that documents the differences between the standard 7.5 .def file and the 7.2 version of the .def file is called 75gp\_supp\_slcrm.htm.

(<http://genesyslab.com/support/dl/retrieve/default.asp?item=AED517861584138211800F72777D80EC&view=item>).

Use the appropriate migration-oriented HTML file to update your customized version of the 6.5.2, 7.0, 7.1, or 7.2.def file so that it can be used as a *Gplus* Adapter 7.5 .def file.

---

**Note:** You can update a .def file for only one version at a time.

---

To migrate from the 6.5.2 version to the 7.5 version of the .def file:

1. Apply the differences between the 6.5.2 and the 7.0 versionS.
2. Apply the differences between the 7.0 and the 7.1 versions.
3. Apply the differences between the 7.1 and the 7.2 versions.
4. Apply the differences between the 7.2 and the 7.5 versions.

This converts your customized *Gplus* Adapter 6.5.2, 7.0, 7.1, or 7.2 .def file into a *Gplus* Adapter 7.5 .def file.

Test the converted .def file after making any changes. Genesys Laboratories does not guarantee the success of this conversion procedure.

Some of the changes you can make to upgrade a 6.5.2, 7.0, 7.1, or 7.2 .def file are not mandatory, and some are not required unless you are working with a specific *Gplus* Adapter for Siebel CRM component or option. The migration-oriented HTML file (70gp\_supp\_sl7.html, 71gp\_supp\_sl7.html, 72gp\_supp\_slcrm.html, or 75gp\_supp\_slcrm.htm) provides information about each of the sections of the .def file, what they are used for, and how they can be modified during migration.





**Part**

# 22

## **The Gplus Adapter for PeopleSoft CRM**

This section describes the preliminary migration procedures and the migration order for the *Gplus* Adapter for PeopleSoft CRM. It contains the following chapters:

- [Chapter 71, “Introduction to the Gplus Adapter for PeopleSoft CRM Migration,” on page 1177](#), discusses the preliminary migration procedures, the prerequisite migration steps, and the reference material for migrating from release 7.0 to 7.1, from release 7.0 to 7.2, and from release 7.1 to 7.2.
- [Chapter 72, “Migration Procedures,” on page 1179](#), discusses the procedures for migrating the Gplus Adapter for People CRM from release 7.0 to 7.1, 7.0 to 7.2 and 7.1 to 7.2.





## Chapter

# 71

## Introduction to the Gplus Adapter for PeopleSoft CRM Migration

This chapter discusses the preliminary migration procedures and the reference materials for migrating from release 7.0 to 7.1, from release 7.0 to 7.2, and from release 7.1 to 7.2 of the *Gplus* Adapter for PeopleSoft CRM.

There are three main sections to this chapter:

- [Before You Begin](#), page 1177
- [Prerequisite Migration Procedures](#), page 1178
- [Reference Materials](#), page 1178

---

## Before You Begin

Before you begin the migration procedures for the *Gplus* Adapter for PeopleSoft CRM, review the following information:

1. Chapter 1, “Migration Roadmap,” on [page 35](#).
2. The licensing requirements for the other Genesys products (for example T-Servers) that the Adapter requires. See Chapter 2, “Licensing Migration,” on [page 41](#).
3. See the *Genesys 7 Interoperability Guide* and the *Genesys 8 Interoperability Guide* for information on the compatibility of Genesys products with various Configuration Layer Environments; Interoperability of Reporting Templates and Solutions; and *Gplus* Adapters Interoperability.

---

## Prerequisite Migration Procedures

Before you begin your migration of the Adapter, complete the following preliminary procedures:

1. License the Genesys products that are required in order to support your release of the Adapter.

For more information about licensing, see:

- The *Genesys Licensing Guide*.
- Chapter 2, “Licensing Migration,” on [page 41](#) in this guide

2. Migrate Genesys Framework from release 7.0 to 7.1, from release 7.0 to 7.2, or from release 7.1 to 7.2, as necessary.

3. Upgrade other products (including Genesys products) that are required for your implementation of the Adapter.

The Adapter’s system requirements for other Genesys products vary, depending on the Adapter components and features that you intend to install. For more information about the system requirements, see the system requirements sections in the *Gplus Adapter 7 for PeopleSoft CRM Deployment Guide*, and the product’s Release Advisory.

---

## Reference Materials

- *Genesys Licensing Guide*
- *Genesys 7 Interoperability Guide*
- *Genesys 8 Interoperability Guide*

For release 7.0 of the Adapter:

- *Gplus Adapter 7 for PeopleSoft CRM Deployment Guide*

For release 7.1 of the Adapter:

- *Gplus Adapter 7.1 for PeopleSoft CRM Deployment Guide*

For release 7.2 of the Adapter:

- *Gplus Adapter 7.2 for PeopleSoft CRM Deployment Guide*



## Chapter

# 72

## Migration Procedures

This chapter discusses the migration procedures for migrating the *Gplus* Adapter for PeopleSoft CRM from release 7.0 to 7.1 and from release 7.0 or 7.1 to 7.2.

There are two main sections in this chapter:

- [“Migrating the Gplus Adapter for PeopleSoft CRM” on page 1179](#)
- [“Migrating from Release 7.0 or 7.1 to 7.2” on page 1182](#)

---

## Migrating the Gplus Adapter for PeopleSoft CRM

### Migration from Release 7.0 to 7.1

This section discusses the procedures for migrating the *Gplus* Adapter for PeopleSoft CRM from release 7.0 to 7.1.

There are nine main topics in this section:

- [Migration Procedures, page 1180](#)
- [Migrating the Adapter from Release 7.0 to 7.1, page 1180](#)
- [Upgrading to PeopleTools 8.47, page 1181](#)
- [Backing Up the Customization Points, page 1181](#)
- [Uninstalling the 7.0.0/7.0.1 Adapter, page 1181](#)
- [Importing the Adapter 7.1 Template, page 1182](#)
- [Creating the Application Object, page 1182](#)
- [Configuring the Adapter, page 1182](#)
- [Installing a Warm Standby Adapter \(Optional\), page 1182](#)

## Migration Procedures

Before you begin your migration, you must complete the migration of all products that are required for the 7.1 release of the Adapter, including any related licensing procedures. See “Migrating the Adapter from Release 7.0 to 7.1” on [page 1180](#).

Migrating the Adapter from release 7.0 to 7.1 is not complicated in itself: you simply uninstall the previous release of the Adapter, and then install the new release according to the instructions in the current product’s *Deployment Guide*. The part of the migration process that is more difficult is the replication of any existing customizations that your organization has made to the Adapter.

Customizations to the PeopleSoft and *Gplus* Adapter products can take many forms, and therefore it is impossible to provide specific instructions for re-implementing the particular customizations that your organization has performed. Nevertheless, this section does describe methods that can help migrate some of the customizations.

### Upgrading to Genesys Framework 7.1

Upgrade Genesys Framework components to release 7.1.

## Migrating the Adapter from Release 7.0 to 7.1

After you complete all the prerequisites for migrating the *Gplus* Adapter you can perform the actual migration process, which consists of the following steps:

1. Upgrade the PeopleTools environment to version 8.47
2. Back up the following Customization Point files:
  - `CustomInteractionHandler.java`
  - `CustomDialingPlanMapper.java`
3. Uninstall the 7.0.0/7.0.1 Adapter
4. Import the Adapter 7.1 template
5. Create the new Application object
6. Install the new Adapter
7. Configure the application:
  - Copy the applicable configuration options from the old application.
  - If the `CustomInteractionHandler` and/or `CustomDialingPlanMapper` Customization Points were modified in the previous release, merge the changes into the new versions and recompile them. For more information, see the *Gplus Adapter 7.1 for PeopleSoft CRM Deployment Guide* for more information.
8. (Optional,) Install and configure a Warm Standby instance of the Adapter



The migration procedures in the rest of this chapter assume that your organization has made modifications to customize the standard PeopleSoft and the *Gplus* Adapter products, and that you wish to implement these customizations in your upgraded releases as well. In some cases, new features and options that are available in the 7.1 release of the Adapter supersede related capabilities that are available in your earlier version. In these cases, you should use the new, standard Adapter features and options.

## Upgrading to PeopleTools 8.47

The 7.1 Adapter is compatible with PeopleTools 8.47 only. Therefore, this upgrade is required. For details, see your PeopleSoft documentation.

## Backing Up the Customization Points

Before you uninstall the previous release of the Adapter, you must back up the Customization Point files. For more information about Customization Points, see “Advanced Topics” in the *Gplus Adapter 7.1 for PeopleSoft CRM Deployment Guide*.

To back up the Customization Point files:

1. Before you uninstall the previous release of the Adapter, go to the `com\genesyslab\gplus\peoplesoft\custom\` subdirectory of the installation directory, and copy the two Java files `CustomInteractionHandler.java` and `CustomDialingPlanMapper.java` to a safe location.
2. After you install 7.1 Adapter, manually compare the backed-up files to the new 7.1 Customization Point files.
3. Update the 7.1 files with all pertinent logic from the original files.

---

**Note:** In the 7.1 release, the method signatures for the `CustomDialingPlanMapper` Customization Point have changed, in order to accommodate the Network Transfer capability.

---

4. Compile the 7.1 Customization Point files as described in “Compiling Customization Points” in the *Gplus Adapter 7.1 for PeopleSoft CRM Deployment Guide*.

## Uninstalling the 7.0.0/7.0.1 Adapter

Refer to the appropriate “Uninstalling the Adapter” section in the *Gplus Adapter 7.1 for PeopleSoft CRM Deployment Guide*, depending on your platform (AIX or Windows).

## Importing the Adapter 7.1 Template

For details, see “Importing the Application Template” in the *Gplus Adapter 7.1 for PeopleSoft CRM Deployment Guide*.

---

**Note:** You cannot use the same template or Application object that was used for release 7.0.0 or 7.0.1, because the application type has changed to Genesys Generic Server.

---

## Creating the Application Object

For details, see “Creating and Configuring the Application” in the *Gplus Adapter 7.1 for PeopleSoft CRM Deployment Guide*.

## Configuring the Adapter

For details, see “Creating and Configuring the Application” in the *Gplus Adapter 7.1 for PeopleSoft CRM Deployment Guide*.

## Installing a Warm Standby Adapter (Optional)

Installing a Warm Standby instance of the Adapter is optional. For information about installing and configuring a Warm Standby instance, see the *Gplus Adapter 7.1 for PeopleSoft CRM Deployment Guide*.

---

# Migrating from Release 7.0 or 7.1 to 7.2

This section discusses the procedures for migrating the *Gplus* Adapter for PeopleSoft CRM from release 7.0 to 7.2, and from release 7.1 to 7.2.

There are nine main topics in this section:

- [Migration Procedures](#), page 1183
- [Migrating the Adapter from Release 7.0 or 7.1 to 7.2](#), page 1183
- [Upgrading to PeopleTools 8.48](#), page 1184
- [Backing Up the Customization Points](#), page 1181
- [Backing Up the Customization Points](#), page 1181
- [Importing the Adapter 7.2 Template](#), page 1185
- [Creating the Application Object](#), page 1182
- [Configuring the Adapter](#), page 1182
- [Installing a Warm Standby Adapter \(Optional\)](#), page 1182

## Migration Procedures

This section discusses the procedures for migrating the *Gplus* Adapter for PeopleSoft CRM from release 7.0 to 7.2, or from release 7.1 to 7.2.

Before you begin your migration, you must complete the migration of all products that are required for the 7.2 release of the Adapter, including any related licensing procedures. See “Migrating the Adapter from Release 7.0 or 7.1 to 7.2” on [page 1183](#).

Migrating the Adapter from release 7.0 or 7.1 to 7.2 is not complicated in itself- you simply uninstall the previous release of the Adapter, and then install the new release according to the instructions in the current product’s *Deployment Guide*. The part of the migration process that is more difficult is the replication of any existing customizations that your organization has made to the Adapter.

Customizations to the PeopleSoft and *Gplus* Adapter products can take many forms, and therefore it is impossible to provide specific instructions for re-implementing the particular customizations that your organization has performed. Nevertheless, this chapter does describe methods that can help migrate some of the customizations.

### Upgrading to Genesys Framework 7.2

Upgrade Genesys Framework components to release 7.2.

## Migrating the Adapter from Release 7.0 or 7.1 to 7.2

After you complete all the prerequisites for migrating the Adapter, you can perform the actual migration process, which consists of the following steps:

1. Upgrade the PeopleTools environment to version 8.48
2. Back up the following Customization Point files:
  - `CustomInteractionHandler.java`
  - `CustomDialingPlanMapper.java`
3. Uninstall the 7.0.0/7.0.1/7.1.0 Adapter
4. Import the Adapter 7.2 template
5. Create the new Application object
6. Install the new Adapter
7. Configure the application:
  - Copy the applicable configuration options from the old application.

- If the `CustomInteractionHandler` and/or `CustomDialingPlanMapper` Customization Points were modified in the previous release, merge the changes into the new versions and recompile them. For more information, see the *Gplus Adapter 7.2 for PeopleSoft CRM Deployment Guide* for more information.
8. (Optional,) Install and configure a Warm Standby instance of the Adapter
- The migration procedures in the rest of the chapter assume that your organization has made modifications to customize the standard PeopleSoft and the *Gplus* Adapter products, and that you want to implement these customizations in your upgraded releases as well. In some cases, new features and options that are available in the 7.1 or 7.2 release of the Adapter supersede related capabilities that are available in your earlier version. In these cases, you should use the new, standard Adapter feature and options.

## Upgrading to PeopleTools 8.48

The 7.2 Adapter is compatible with PeopleTools 8.48 only. Therefore, this upgrade is required. For details, see your PeopleSoft documentation.

## Backing Up the Customization Points

Before you uninstall the previous release of the Adapter, you must back up Customization Point files. For more information about Customization Points, see “Advanced Topics” in the *Gplus Adapter 7.2 for PeopleSoft CRM Deployment Guide*.

To back up the Customization Point files:

1. Before you uninstall the previous release of the Adapter, go to the `com\genesyslab\gplus\peoplesoft\custom\` subdirectory of the installation directory, and copy the two Java files to a different location.
2. After you install the 7.2 Adapter, manually compare the original files to the new 7.2 Customization Point files.
3. Update the 7.2 files with all pertinent logic from the original files.

---

**Note:** Starting with the 7.1 release, the method signatures for the `CustomDialingPlanMapper` Customization Point have changed, in order to accommodate the Network Transfer capability.

---

4. Compile the 7.2 Customization Point files as described in “Compiling Customization Points” in the *Gplus Adapter 7.2 for PeopleSoft CRM Deployment Guide*.

## Uninstalling the 7.0.0/7.0.1/7.1.0 Adapter

Refer to the appropriate “Uninstalling the Adapter” section in the *Gplus Adapter 7.2 for PeopleSoft CRM Deployment Guide*, depending on your platform (AIX or Windows).

## Importing the Adapter 7.2 Template

For details, see “Importing the Application Template” in the *Gplus Adapter 7.2 for PeopleSoft CRM Deployment Guide*.

---

**Note:** You may not use the same template or application that was used in 7.0.0 or 7.0.1, as the application type has changed to Genesys Generic Server.

---

## Creating the Application Object

For details, see “Creating and Configuring the Application” in the *Gplus Adapter 7.2 for PeopleSoft CRM Deployment Guide*.

## Configuring the Adapter

For details, see “Creating and Configuring the Application” in the *Gplus Adapter 7.2 for PeopleSoft CRM Deployment Guide*.

## Installing a Warm Standby Adapter (Optional)

Installing a Warm Standby instance of the Adapter is optional. For information about installing and configuring a Warm Standby instance, see the *Gplus Adapter 7.2 for PeopleSoft CRM Deployment Guide*.





**Part**

# 23 **Appendices**

This Part contains the following appendices:

- Appendix A, “Login Procedure,” on page 1189 describes a standard login procedure for a Genesys GUI applications such as the Configuration Conversion Wizard.
- Appendix B, “Configuration Server Proxy Log Events Mapping,” on page 1191 determines the correspondence between log events in Configuration Server Proxy 6.5 and Configuration Server 7.0.
- Appendix C, “Genesys Desktop and Related Products” on page 1203 shows that there is no direct migration from existing versions of Internet Contact Solution (ICS) and Genesys Contact Navigator Web (GCN Web) to Multi-Channel Routing (MCR) 7.0 and Genesys Agent Desktop (GAD) 7.0.

See the *Genesys 7 Interoperability Guide* and the *Genesys 8 Interoperability Guide* for information on the compatibility of Genesys products with various Configuration Layer Environments; Interoperability of Reporting Templates and Solutions; and *Gplus* Adapters Interoperability.







## Appendix

# A

## Login Procedure

When you start a Framework GUI application, or if you are being forced to log in again after a period of inactivity, a Login dialog box displays. The Configuration Layer checks the information specified in the Login dialog box and determines the user's permission to view, create, and modify objects in the Configuration Database.

In a Login dialog box:

1. Enter a user name. For logging in to the Configuration Layer for the first time, use the Master Account user name, which is `default`. After the appropriate configuration objects of the Person type are added to the configuration, use a customized user name.
2. Enter a user password. For logging in to the Configuration Layer for the first time, use the Master Account password, which is `password`. After the appropriate configuration objects of the Person type are added to configuration, use a customized password.
3. Click `Details` or `More options` if not more entry fields are displayed.
4. Enter the Application name, which is the instance of the application you are logging in to as it is registered in the Configuration Database.

---

### Notes:

- The predefined name of the Configuration Manager Application is `default`. The Configuration Manager Application object can be renamed later.
- If you are logging in to Genesys Administrator, enter the name of the Configuration Manager Application object with which Genesys Administrator is associated, or bound, when Genesys Administrator.

- 
5. Enter a Host name, which is the name of the computer on which Configuration Server runs.

6. Enter a Port number, which is the communication port that client applications must use to connect to Configuration Server.



Appendix

# B

## Configuration Server Proxy Log Events Mapping

**Note:** If you have already upgraded to 7.x, you can skip this chapter.

Table 203 allows you to determine correspondence between log events in Configuration Server Proxy 6.5 and Configuration Server 7.0. Refer to the *Framework 8.0 Combined Log Events Help* for description of Configuration Server log events.

**Table 203: Log Events Mapping**

Configuration Server Proxy 6.5			Configuration Server 7.0		
ID	Level	Text	ID	Level	Text
21-62100	Standard	[version]	21-22100	Standard	[version]
21-62101	Standard	[copyright]	21-22101	Standard	[copyright]
21-62102	Standard	Authentication library [library], version [version] activated.	21-22112	Standard	Authentication library [library name], version [library version] is activated.
21-62501	Standard	Section [section name] doesn't exist.	21-62501	Standard	Section [section name] doesn't exist.
21-62601	Standard	Export to the file [file name] is being processed.	21-22600	Standard	Export to the file [file name] is being processed.
21-62602	Standard	Export to the file [file name] completed.	21-22601	Standard	Export to the file [file name] is completed.

**Table 203: Log Events Mapping (Continued)**

Configuration Server Proxy 6.5			Configuration Server 7.0		
ID	Level	Text	ID	Level	Text
21-70100	Standard	XML parser error [error], position [position].	N/A		
21-70101	Standard	XML schema: Element [element] has unknown type [type].	N/A		
21-70102	Standard	XML schema: Element [element] has unknown attribute [attribute].	N/A		
21-70103	Standard	XML schema: Schema element [element] is unknown.	N/A		
21-75101	Standard	Connection [socket] has unknown type [type].	N/A		
21-75102	Standard	Connection [socket] has duplicated name.	N/A		
21-75103	Standard	Connection [socket] type [type] has been initialized.	21-22103	Standard	Connection [socket] type [type] has been initialized.
21-75104	Standard	Protocol [protocol] type [type] has been initialized.	21-22104	Standard	Protocol [protocol] type [type] has been initialized.
21-75105	Standard	Processor [processor] is processing message [message ID].	N/A		
21-75106	Standard	Message [message], id [message ID] forwarded to Configuration Server.	N/A		
21-75107	Standard	There are [number] objects of type [type] sent to the client [socket] (application [name], type [type]).	21-24215	Trace	There are [number] objects of type [object type] sent to the client [socket number] (application [application name], type [application type]).

**Table 203: Log Events Mapping (Continued)**

Configuration Server Proxy 6.5			Configuration Server 7.0		
ID	Level	Text	ID	Level	Text
21-75108	Standard	Object [object] is to be added.	21-24210	Trace	Object [object type] is to be added by client, type [application type], name: [application name], user: [user name].
21-75109	Standard	Object [object], DBID [database ID] is to be deleted.	21-24212	Trace	Object [object type], DBID [database ID] is to be deleted by client, type [application type], name: [application name], user: [user name].
21-75110	Standard	[Error].	21-23500	Standard	Configuration Server Error: [error].
21-75111	Standard	Object [object], DBID [database ID] is to be changed.	21-24211	Trace	Object [object type], DBID [database ID] is to be changed by client, type [application type], name: [application name], user: [user name].
21-75112	Standard	Permissions are to be changed.	21-24213	Trace	Permissions are to be changed by client, type [application type], name: [application name], user: [user name].
21-75113	Standard	Account is to be changed.	21-24214	Trace	Account is to be changed by client, type [application type], name: [application name], user: [user name].
21-75114	Standard	Backup server set to [name], DBID [database ID].	21-22107	Standard	Backup server is set to [application name], DBID [ID].
21-75115	Standard	Master server backup is set to [name], DBID [database ID].	21-22700	Standard	Master server backup is set to [application name], DBID [application ID].

**Table 203: Log Events Mapping (Continued)**

Configuration Server Proxy 6.5			Configuration Server 7.0		
ID	Level	Text	ID	Level	Text
21-75116	Standard	[Parameter] is not set. Backup functionality is prohibited.	21-22301	Standard	[Parameter] is not set. Backup functionality is prohibited.
21-80101	Standard	Objectset [object set] has been initialized.	21-22106	Standard	Objectset [object set] has been initialized.
21-81101	Standard	Process coordinator initialized. Number of threads is [number].	N/A		
21-81102	Standard	Process coordinator activated.	21-22109	Standard	Process coordinator is activated.
21-82101	Standard	Schema [schema] has been initialized.	21-22105	Standard	Schema [schema] has been initialized.
21-85100	Standard	Exception class [exception]: [class].	21-23600	Standard	Program exception: [exception].
21-90001	Trace	Objectset [set]: read requests sent.	21-22902	Standard	Objectset [object set name]: read requests sent on [data source].
21-90002	Trace	Message [msg], id [id] is received from [socket] (application [name], type [type]); protocol cfglib.	00-04541 (common log event)	Trace	Message [message type] received from [socket number] ([application type] [application name]).
21-90003	Trace	Response message [msg], id [id] is sent to [socket] (application [name], type [type]); protocol [cfglib].	00-04542 (common log event)	Trace	Message [message type] sent to [socket number] ([application type] [application name]).
21-90004	Trace	Unknown message received from the client [socket].	N/A		
21-90005	Trace	Objectset [set]: data is cleaned up.	21-22906	Standard	Objectset [object set name]: data is cleaned up. Source: [data source].

**Table 203: Log Events Mapping (Continued)**

Configuration Server Proxy 6.5			Configuration Server 7.0		
ID	Level	Text	ID	Level	Text
21-90006	Trace	Error [error] in object [object type], property [property] during processing of request [number].	00-06042 (common log event)	Standard	Configuration data read error: object type: [object type], DBID [object name], reason [reason].
21-90007	Standard	Configuration library schema [file] loaded.	N/A		
21-90101	Standard	Objectset [set] is being loaded.	21-22900	Standard	Objectset [object set name] is being loaded.
21-90102	Standard	Objectset [set] is fully loaded.	21-22904	Standard	Objectset [object set name] is fully loaded.
21-90103	Standard	Objectset [set] failed to load.	21-22905	Standard	Objectset [object set name] failed to load.
21-90104	Standard	Objectset [set]: XML schema loaded.	21-22901	Standard	Objectset [object set name]: XML schema is loaded.
21-90105	Standard	Objectset [set]: data loaded. Now initializing.	21-22903	Standard	Objectset [object set name]: data is loaded. Now initializing.
21-90106	Standard	Objectset [set] - required clusters loaded.	N/A		
21-90107	Standard	Objectset: cache functionality [state].	21-22907	Standard	Objectset: cache functionality [state].
21-90201	Standard	Trying to connect to cfgserver on host [host], port [port].	00-04500 (common log event)	Trace	Connecting to [server type] [server name] at host [host name], port [port number].
21-90202	Standard	Connection to cfgserver, host [host] port [port] is established.	00-04503 (common log event)	Standard	Connected to [server type] [server name] at host [host name], port [port number].
21-90203	Standard	Connection to cfgserver, host [host] port [port] is closed.	00-04505 (common log event)	Standard	Disconnected from [server type] [server name].

**Table 203: Log Events Mapping (Continued)**

Configuration Server Proxy 6.5			Configuration Server 7.0		
ID	Level	Text	ID	Level	Text
21-90204	Standard	Connection to cfserver, host [host] port [port] is terminated.	00-04504 (common log event)	Standard	Connection to [server type] [server name] at host [host name], port [port number] lost.
21-90251	Standard	Trying to connect to dbserver on host [host], port [port].	00-04500 (common log event)	Trace	Connecting to [server type] [server name] at host [host name], port [port number].
21-90252	Standard	Connection to dbserver, host [host] port [port] is established.	00-04503 (common log event)	Standard	Connected to [server type] [server name] at host [host name], port [port number].
21-90253	Standard	Connection to dbserver, host [host] port [port] is closed.	00-04505 (common log event)	Standard	Disconnected from [server type] [server name].
21-90254	Standard	Connection to dbserver, host [host] port [port] is terminated.	00-04504 (common log event)	Standard	Connection to [server type] [server name] at host [host name], port [port number] lost.
21-90255	Standard	Trying to open database [database name], SQL server [server name].	21-24400	Trace	Trying to open database [database name], SQL server [server name].
21-90256	Standard	Database [database name] opened.	00-07001 (common log event)	Standard	Database [database name] opened.
21-90257	Standard	Configuration database version is [release number].	21-22913	Standard	Configuration database version is [release number].
21-90258	Standard	Objectset [object set name] read error: [error].	21-22908	Standard	Objectset [object set name] read error: [error].
21-90259	Standard	Database schema [file name] is loaded.	21-22910	Standard	Database schema [file name] is loaded.
21-90260	Standard	Objectset [object set name]: read requests sent on [data source].	21-22902	Standard	Objectset [object set name]: read requests sent on [data source].



**Table 203: Log Events Mapping (Continued)**

Configuration Server Proxy 6.5			Configuration Server 7.0		
ID	Level	Text	ID	Level	Text
21-90261	Standard	Backup server [application name] on [host name:port number] is set up in the configuration.	21-22911	Standard	Backup server [application name] on [host name:port number] is set up in the configuration.
21-90262	Standard	Another Configuration Server detected.	21-22300	Standard	Another Configuration Server detected.
21-90263	Standard	No Application object found for the [application name]. Exiting.	21-22914	Standard	No Application object found for the [application name]. Exiting.
21-90301	Standard	LCA Layer is connected at [host]:[port].	21-22500	Standard	LCA is connected at [[host name]:[port number]].
21-90302	Standard	LCA Layer disconnected.	21-22501	Standard	LCA is disconnected.
21-90303	Standard	LCA Layer signal [switch to the primary mode] is received.	21-22502	Standard	LCA signal [switch to the primary mode] is received.
21-90304	Standard	LCA Layer signal [switch to the backup mode] is received.	21-22503	Standard	LCA signal [switch to the backup mode] is received.
21-90305	Standard	LCA Layer signal [terminate] is received.	21-22504	Standard	LCA signal [terminate] is received.
21-90306	Standard	LCA Layer could not be started. No data.	21-22505	Standard	Connection to LCA cannot be established. No data.
21-90307	Standard	LCA Layer port is changed: [host]:[port].	21-22506	Standard	LCA port is changed: [[host name]:[port number]].
21-90501	Standard	Query syntax error: [error].	21-22916	Standard	Query processing error: [error].

**Table 203: Log Events Mapping (Continued)**

Configuration Server Proxy 6.5			Configuration Server 7.0		
ID	Level	Text	ID	Level	Text
21-90601	Trace	Message [message] received from [socket]; protocol [TELNET].	00-04543 (common log event)	Interaction	Interaction message “[message type]” received from [socket number] (“[application name]”).
21-90602	Trace	Message [message] sent to [socket]; protocol [TELNET].	00-04542 (common log event)	Trace	Message [message type] sent to [socket number] ([application type] [application name]).
21-90701	Standard	Object [type], DBID [database ID] is added.	21-24205	Trace	Notification: Object [object type], name [object name], DBID: [database ID] is created at server.
21-90702	Standard	Object [type], DBID [database ID] is changed.	21-24206	Trace	Notification: Object [object type], name [object name], DBID: [database ID] is changed at server.
21-90703	Standard	Object [type], DBID [database ID] is deleted.	21-24207	Trace	Notification: Object [object type], name [object name], DBID: [database ID] is deleted at server.
21-90704	Standard	Object [type], DBID [database ID] access is changed.	21-24208	Trace	Notification: Object [object type], name [object name], DBID: [database ID] access is changed at server.
21-90705	Standard	Object [type], DBID [database ID] account is changed.	21-24209	Trace	Notification: Object [object type], name [object name], DBID: [database ID] account is changed at server.
21-90801	Standard	Encoding [encoding] is set successfully.	21-22110	Standard	Encoding [encoding name] is set successfully.

**Table 203: Log Events Mapping (Continued)**

Configuration Server Proxy 6.5			Configuration Server 7.0		
ID	Level	Text	ID	Level	Text
21-90802	Standard	Encoding [encoding] could not be set. Return to default [default encoding].	21-22111	Standard	Encoding [encoding name] could not be set. Return to default [default encoding name].
21-90901	Standard	Transaction manager activated.	21-22108	Standard	Transaction manager is activated.
21-91101	Standard	Port [port] for the [protocol] protocol opened.	21-22800	Standard	Extended info: Port [port number], protocol [protocol] opened for listening.
21-91102	Standard	Port [port] for the [protocol] protocol closed.	21-22801	Standard	Port [port number], protocol [protocol] closed.
21-91103	Trace	New client [socket] connected; protocol [protocol].	21-24300	Trace	Extended info: New client [socket number] connected, protocol [protocol].
21-91104	Trace	Client [socket] (application [application], type [type]) disconnected; protocol [protocol].	21-24301	Trace	Extended info: Client [socket number] disconnected, application [application name], type [application type], protocol [protocol].
21-91105	Trace	Message [message type] received from [socket number] ([application type] [application name]).	00-04541 (common log event)	Trace	Message [message type] received from [socket number] ([application type] [application name]).
21-91106	Trace	Message [message type] sent to [socket number] ([application type] [application name]).	00-04542 (common log event)	Trace	Message [message type] sent to [socket number] ([application type] [application name]).
21-91107	Trace	Message is not sent on [socket number], protocol [protocol], reason [error].	21-24305	Trace	Message is not sent on [socket number], protocol [protocol], reason [error].

**Table 203: Log Events Mapping (Continued)**

Configuration Server Proxy 6.5			Configuration Server 7.0		
ID	Level	Text	ID	Level	Text
21-91108	Trace	Client connection [socket] is suspended	N/A		
21-91109	Trace	Client connection [socket] is expired	N/A		
21-91110	Trace	Connection [socket number], protocol [protocol] acquired session parameters from the connection [old socket number]. The latter is disposed of.	21-24302	Trace	Connection [socket number], protocol [protocol] acquired session parameters from the connection [old socket number]. The latter is disposed of.
21-91111	Standard	Data read error, client [client ID], socket number [socket number], error code [error code].	00-02101 (common log event)	Standard	Data read error, client [client ID], socket number [socket number], error code [error code].
21-91112	Standard	Data send error, client [client ID], socket number [socket number], error code [error code].	00-02102 (common log event)	Standard	Data send error, client [client ID], socket number [socket number], error code [error code].
21-91201	Standard	No object found for the delta [delta], DBID [ID].	N/A		
21-91202	Standard	Initialization error: [error], object: [object], name: [name], DBID: [ID], property: [property]. Reason: [reason].	21-22400	Standard	Initialization error: [error], object: [object], name: [name], DBID: [ID], property: [property]. Reason: [reason].
21-91301	Standard	Transaction [transaction ID] sent on execution.	21-24218	Trace	Transaction [transaction ID] sent on execution.
21-91302	Standard	Transaction [transaction ID] committed.	21-24216	Trace	Transaction [transaction ID] committed.
21-91303	Standard	Transaction [transaction ID] rolled back.	21-24217	Trace	Transaction [transaction ID] rolled back.

**Table 203: Log Events Mapping (Continued)**

Configuration Server Proxy 6.5			Configuration Server 7.0		
ID	Level	Text	ID	Level	Text
21-91401	Standard	Server mode is set to [mode].	21-22915	Standard	Server mode is set to [mode].
21-91402	Standard	Server application name is set to [name].	21-22102	Standard	Server application name is set to [application name].





## Appendix

# C

## Genesys Desktop and Related Products

There is no direct migration from existing versions of Internet Contact Solution (ICS) and Genesys Contact Navigator Web (GCN Web) to Multimedia 7.6 and Genesys Desktop (GAD/GSD) 7.6.

However, the migration process from existing versions of Genesys Desktop 7.x to the 7.6 version is made possible by using certain data, which was created in previous versions, and updating this data in the 7.6 application. You may choose to continue using features from previous versions of Genesys Desktop; however, if you want to use 7.6 functionality, you must import and apply the latest GAD and GSD templates.

- For instructions that enable you to transition from previous versions of Genesys Desktop to Genesys Desktop 7.6, see Chapter 1, “Getting Started,” in the *Genesys Desktop 7.6 Deployment Guide*.
- For instructions on how to transition from previous versions of Interaction SDK API to Genesys Developer Interaction SDK 7.6, refer to the *Interaction SDK 7.6 Java Developer’s Guide*.
- For instructions on converting the ICS 6.x Contact Server database for use in Multimedia, see the chapter on transitioning to Multimedia from ICS 6.x in the *Multimedia 7.6 User’s Guide*.

### Genesys Desktop 7.2 to 7.5 Migration

During migration from Genesys Desktop 7.2 to 7.5, two default view profiles could be created in certain scenarios. They have the same name, but different IDs. One is the real default profile and the other is a copy. If the real profile is deleted, then a supervisor that is accessing the default profile may get the copy instead.

### Genesys Desktop 7.5 to 7.6 Migration

[Table 204](#) details the following Genesys Desktop 7.5 options that have been renamed for 7.6 and later releases.

**Table 204: Genesys Desktop 7.5 Options That Are Renamed in Genesys Desktop 7.6 and Later**

7.5 Options	Renamed in 7.6
timeInStateRange=-1	time-in-state-range=-1
agentReasonsRange=-1	agent-reasons-range=-1
statDeLay=-1	stat-deLay=-1
loadScRiptDeLay=-1	load-scr ipt-de lay=-1





# Index

## Numerics

6.1 and 6.5.0 to 7.x Statistics API . . . . .	171
6.5 features	
component compatibility . . . . .	567, 577, 583
component matrix . . . . .	567, 577, 583
6.5.1 to 7.x Configuration API . . . . .	177

## A

ADDP . . . . .	65
Administration Console	
See Genesys Info Mart	
AnswerMethod . . . . .	676
Application Options	
changes for GIS . . . . .	167
applications	
that must be stopped . . . . .	228
architecture	
Framework . . . . .	185
Reporting . . . . .	184
Automatic Disconnect Detection Protocol . . . . .	65

## B

Backwards Compatibility	
for configuration data . . . . .	171
BrioQuery Designer . . . . .	183, 191
Business Attributes (formerly Enumerators) . . . . .	75

## C

Call Concentrator	
changes to configuration options . . . . .	554
compatibility among components . . . . .	551
Interoperability . . . . .	551
Migration and Upgrade Order . . . . .	550
migration from 6.1 to 7.0 . . . . .	555
Multi-Site/Single-Site and Multi-Tenant	
Migration . . . . .	550
multi-site/single-site and multi-tenant migration	
549	
preliminary migration procedures . . . . .	549
Call Handling Differences . . . . .	1131

Call-Attached Data	
changing routing strategies . . . . .	1133
consult calls . . . . .	1134
CallRecovery . . . . .	676
CampCancel stat type . . . . .	233
canceling	
the upgrade . . . . .	230
CC Analyzer architecture	
differences between releases . . . . .	184
CC Pulse+ architecture	
differences between releases . . . . .	185
ccpulse/ccpulse+ features . . . . .	193
CD	
Voice Treatment Option 6.5 . . . . .	677
Changes in Routing Strategies . . . . .	1133
Changes to Configuration Options for Voice	
Callback 7.0 . . . . .	633
Changes to Statistics API Methods from 6.1 and	
6.5.0 to 7.x . . . . .	172
check_error	
GIS application option . . . . .	168
common log options . . . . .	99
comparing	
stat type definitions between releases . . . . .	224
Compatibility Among Components of Call	
Concentrator . . . . .	551
component	
changes, VTO . . . . .	652
Framework . . . . .	652
VTO, 5.1 to 6.5 . . . . .	655
Component Compatibility for VTO 7.0 . . . . .	653
components . . . . .	219
6.5 feature compatibility . . . . .	567, 577, 583
upgrading . . . . .	616
conditions	
for running the service pack . . . . .	218, 219
configuration	
MSSSIsvr.ini file . . . . .	519
Configuration API	
methods . . . . .	173
Configuration Conversion Wizard	
configuration file . . . . .	79
installation . . . . .	76
Configuration Conversion Wizard options	
dbengine . . . . .	77

- dbname . . . . . 78
  - dbrequest-timeout . . . . . 78
  - dbserver . . . . . 78
  - dbtimeout . . . . . 78
  - delete-in-size . . . . . 79
  - host . . . . . 77
  - password . . . . . 78
  - port . . . . . 77, 167
  - username . . . . . 78
  - Configuration Data
    - backwards compatibility . . . . . 171
  - Configuration Database . . . . . 61
    - 8.0 format . . . . . 61
    - database types . . . . . 84
    - migrating . . . . . 67
  - configuration files
    - Configuration Conversion Wizard . . . . . 79
  - Configuration Manager . . . . . 676
    - installation . . . . . 76, 118
  - configuration option changes
    - Genesys Expert Contact . . . . . 872
  - configuration options . . . . . 199
  - Configuration Server
    - installation . . . . . 75, 118
  - Configuration Server Proxy
    - log events mapping . . . . . 1191
  - Configuration Wizards . . . . . 115, 116
  - configure . . . . . 1147
  - Configuring
    - Microsoft ODBC Data Source . . . . . 700
  - configuring VTO
    - enterprise routing solution . . . . . 657
    - independently . . . . . 660
  - CTI-Less T-Server
    - licensing . . . . . 875, 878
    - rollback . . . . . 877
    - upgrade . . . . . 876
  - CutCallsOnTDisconnect . . . . . 677
- D**
- Data Source
    - selecting Microsoft ODBC . . . . . 700
  - Data Sourcer
    - required version . . . . . 228
  - Database
    - installing Microsoft ODBC drivers . . . . . 700
  - database types
    - scripts for Configuration Database . . . . . 84
    - upgrade scripts for Log Database . . . . . 120
  - DB Server
    - installation . . . . . 75, 118
  - DB2
    - script for Configuration Database . . . . . 84
    - upgrade script for Log Database . . . . . 121
  - dbengine
    - Configuration Conversion Wizard . . . . . 77
    - dbname
      - Configuration Conversion Wizard . . . . . 78
    - dbrequest-timeout
      - Configuration Conversion Wizard . . . . . 78
    - dbserver
      - Configuration Conversion Wizard . . . . . 78
    - dbtimeout
      - Configuration Conversion Wizard . . . . . 78
    - delete-in-size
      - Configuration Conversion Wizard . . . . . 79
    - directory, SysDigits.VOX . . . . . 677
    - DMA
      - synchronizing stat type definitions . . . . . 233
    - DMX
      - configuration options changes . . . . . 501
    - DMX (Distributed Media Exchange) . . . . . 441, 462
    - Dropping Conference Calls . . . . . 1132
- E**
- Enumerators (now Business Attributes) . . . . . 75
  - error messages . . . . . 232
  - executable
    - VT Server . . . . . 677
- F**
- feature changes, VTO 6.5 . . . . . 653
  - features
    - 6.5 and component matrix . . . . . 567, 577, 583
    - CC Analyzer 5.1.6 . . . . . 198
    - CC Analyzer 6.0 . . . . . 196
  - FLEXIm
    - version compatibility . . . . . 43
  - formulas
    - Service Factor . . . . . 220
  - Framework . . . . . 57
    - component changes . . . . . 89
    - configuration option changes . . . . . 99
    - GIS Migration 6.1 or 6.5.0 to 7.0 . . . . . 166
    - GIS Migration 6.5.1 to 7.x . . . . . 164, 165
    - GIS Migration 7.2 to 7.5 . . . . . 163
    - migration process . . . . . 61
    - SDK System Requirements for 7.0 . . . . . 163
    - upgrading components . . . . . 115
- G**
- GCN Web . . . . . 879
  - GCN Web, Genesys Contact Navigator Web . . . . . 1203
  - Genesys Agent Desktop . . . . . 1203
  - Genesys Contact Navigator Web . . . . . 1203

- Genesys Desktop . . . . . 872, 873, 879, 1203
  - Component Changes for Genesys Expert Contact 7.x . . . . . 872
  - Configuration Option Changes for Expert Contact . . . . . 872, 873
  - Desktop Component and CTI-Less T-Server Compatibility . . . . . 871
- Genesys Desktop 7.x . . . . . 871
- Genesys Developer Interaction SDK . . . . . 1203
- Genesys Expert Contact
  - component changes for 7.0 . . . . . 872
  - configuration option changes . . . . . 872
  - interoperability among components . . . . . 869
  - migration order . . . . . 866
  - single-site/multi-site and multi-tenant migration 866
- Genesys Framework SDK . . . . . 159
  - Configuration API . . . . . 173
  - Session API . . . . . 172
- Genesys Info Mart
  - 2007 daylight saving time changes . . . . . 834
  - ADMIN\_LOAD\_HISTORY . . . . . 833
  - Administration Console . . . . . 772, 836
  - attached data specification . . . . . 831
  - audit dimension . . . . . 774
  - batch files . . . . . 812, 815
  - Business Objects Data
    - Integrator . . . . . 773, 774, 839, 841
  - ccon\_adata\_spec.xml . . . . . 831
  - CLASSPATH environment variable . . . . . 834
  - code page . . . . . 856
  - configuration changes
    - 7.0.2 . . . . . 857
    - 7.2 . . . . . 850
  - configuration option changes
    - 7.0.1 to 7.0.2 . . . . . 791
    - 7.0.2 to 7.2 . . . . . 786
    - 7.2.x to 7.5.x . . . . . 782
    - 7.5.x to 7.6.x . . . . . 775
  - Data Integrator configuration file . . . . . 854
  - DATA\_COLLISION\_FLAG . . . . . 772
  - datastore configurations . . . . . 847
  - discontinued support
    - 7.5 . . . . . 772
    - 7.6 . . . . . 770
  - ETL jobs . . . . . 836, 839
  - EVREFEX\_VIEW . . . . . 850
  - gim\_etl\_server.bat file . . . . . 812, 815
  - gim\_etl\_update\_service\_arguments.bat file . . . . . 812, 815
  - GSW\_CALL\_ATTEMPT\_GUID KVP . . . . . 848
  - high availability deduplication . . . . . 771
  - intraday loading . . . . . 772
  - intra-IDB merge . . . . . 771
  - JDBC DAP . . . . . 832
  - job scheduling . . . . . 773
  - Job\_ExtractCCON . . . . . 772, 850
  - Job\_ExtractCFG . . . . . 772
  - Job\_ExtractSS . . . . . 850
  - Job\_InitializeGIM . . . . . 847
  - Job\_LoadGIM . . . . . 833
  - Job\_LoadRecent . . . . . 772, 833
  - Job\_MaintainGIM . . . . . 836
  - Job\_MigrateGIM . . . . . 766, 811, 826
  - Job\_TransformGIM . . . . . 833
  - load\_gim\_staging\_area.sql script . . . . . 817, 846
  - local repository . . . . . 839, 840, 847
  - make\_cdr\_primary\_keys.sql script . . . . . 849
  - make\_evrefex\_view.sql script . . . . . 849
  - make\_gim\_tenant\_view.sql script 835, 846, 856
  - make\_gim\_view\_for\_tenant.sql script . . . . . 819
  - make\_gim\_view.sql script . . . . . 818, 835, 846, 856
  - make\_icon\_indexes\_for\_gim.sql script . . . . . 813, 831
  - make\_iconmm\_indexes\_for\_gim.sql script . . . . . 813, 825
  - mark\_duplicate\_gim\_facts.sql script . . . . . 836
  - metadata . . . . . 840, 853
  - migrate\_gim\_done.sql script . . . . . 828
  - migrate\_gim\_staging\_area.sql script . . . . . 817, 834, 845, 855
  - migrate\_gim.sql script . . . . . 818, 835, 846, 855
  - migration planning
    - 7.0.1 to 7.0.2 . . . . . 851
    - 7.0.2 to 7.2 . . . . . 837
    - 7.2 to 7.5 . . . . . 829
    - 7.5 to 7.6 . . . . . 810
  - migration procedure
    - 7.0.1 to 7.0.2 . . . . . 854
    - 7.0.2 to 7.2 . . . . . 841
    - 7.2 to 7.5 . . . . . 831
    - 7.5 to 7.6 . . . . . 814
  - mixed database environments . . . . . 774
  - multi-IDB merge . . . . . 771
  - new features and functionality
    - 7.0.2 . . . . . 774
    - 7.2 . . . . . 772
    - 7.5 . . . . . 771
    - 7.6 . . . . . 766
  - non-JDBC DAP . . . . . 836
  - pre-migration procedure
    - 7.0.1 to 7.0.2 . . . . . 852
    - 7.0.2 to 7.2 . . . . . 839
    - 7.2 to 7.5 . . . . . 831
    - 7.5 to 7.6 . . . . . 811
  - purge flag . . . . . 836
  - schema changes
    - 7.0.2 . . . . . 807
    - 7.2 . . . . . 801
    - 7.5 . . . . . 798
    - 7.6 . . . . . 792
  - SQL scripts, for migration
    - from 7.0.1 to 7.0.2 . . . . . 853, 855
    - from 7.0.2 to 7.2 . . . . . 840, 845–846, 849

- from 7.2 to 7.5 . . . . . 831, 834, 835
    - from 7.5 to 7.6 . . . . . 813, 816–819, 825, 828
  - system locale . . . . . 854
  - trigger . . . . . 850
  - upgrade\_merging\_to\_76006.sql script . . . . . 826
  - virtual queue. . . . . 771
  - voice\_reasons\_<rdbs>.sql script . . . . . 845
  - Genesys Interface Server
    - See GIS
  - Genesys Security Using the TLS Protocol .92, 93
    - Configuration Server . . . . . 93
    - DB Server . . . . . 92
    - SCS . . . . . 93
  - Genesys Supervisor Desktop . . . . . 1203
  - Genesys Voice Platform
    - See GVP
  - GIS
    - application option changes . . . . . 167
    - check\_error option. . . . . 168
    - method updates . . . . . 172
    - migrating. . . . . 165, 166
    - restriction\_time option. . . . . 167
    - ScopeStatEvents option. . . . . 167
    - sessionTimeout option . . . . . 167
    - system requirements . . . . . 162, 163
    - System Requirements for 7.0 . . . . . 163
    - System Requirements for 7.2 (or later) . . . . . 162
    - System Requirements for 7.x . . . . . 162
    - updated operations and messages . . . . . 172
    - viewing configuration objects . . . . . 173
  - GIS Genesys Interface Server (GIS). . . . . 159
  - GIS Migration 6.1 or 6.5.0 to 7.0 . . . . . 166
  - GIS Migration 6.5.1 to 7.0 . . . . . 165
  - GIS System Requirements for 7.x . . . . . 162
  - Global Interaction Type. . . . . 577
  - Gplus Adapter 7 for mySAP ERP
    - changes in configuration options . . . . . 1137
    - changes to configuration options . . . . . 1138
    - migrating
      - queue configuration . . . . . 1149
    - migration and upgrade order . . . . . 1130
    - migration of 6.1 T-Gate to Gplus Adapter 7 . . . . . 1145
    - Multi-DN Telesets . . . . . 1147
    - preliminary procedures . . . . . 1129
  - Gplus Adapter 7 for Siebel 7
    - component changes . . . . . 1162, 1163
    - from 6.5.2 to 7.0 . . . . . 1167
    - migration procedures . . . . . 1169, 1184
    - preliminary migration procedures . . . . . 1157, 1177
    - pre-requisite procedures . . . . . 1168
    - upgrading customized GenComm7\_universal .def File . . . . . 1172
  - Gplus Adapter 7 for Siebel 7 (CRM) . . . . . 1155
    - component changes. . . . . 1164
  - Gplus Adapter for PeopleSoft CRM . . . . . 1175
    - migration procedures . . . . . 1181
    - prerequisite procedures . . . . . 1178
  - Gplus Adapter for PeopleSoft CRM Release 7.0 or 7.1 to 7.2 Migration. . . . . 1182
  - Gplus Adapter for PeopleSoft CRM Release 7.0 to 7.1 Migration . . . . . 1179
  - Gplus Foundation Real-Time Statistics API . 159
  - GVP 7.x
    - upgrading . . . . . 1105–1107
  - GVP 8.x
    - and licensing requirements . . . . . 1053
    - compatibility among components . . . . . 1057
    - component changes . . . . . 1060, 1075
    - configuration option changes . . . . . 1065–1073
    - database
      - schema changes . . . . . 1074, 1084
      - upgrading, Microsoft SQL Server . . . . . 1095
      - upgrading, Oracle . . . . . 1096
    - directories changed . . . . . 1061
    - functionality changed . . . . . 1061, 1062, 1064
    - functionality enhanced 1062, 1063, 1064, 1065, 1078
    - High Availability . . . . . 1062
    - High Availability migration. . . . . 1099
    - interoperability . . . . . 1056
    - migration order . . . . . 1054
    - migration overview . . . . . 1055
    - migration procedures . . . . . 1088, 1092, 1105
    - new Application Templates . . . . . 1061
    - new components . . . . . 1060, 1062, 1075, 1076
    - new features . . 1060, 1061, 1063, 1064, 1075, 1078
    - operating system support . . . . . 1060
    - preliminary migration procedures . . 1053, 1087
    - reference materials . . . . . 1054
    - speech engine support . . . . . 1060
    - upgrading . . . . . 1088–1091, 1092–1094
- ## H
- High Availability Reporting . . . . . 213
  - HMP functionality
    - licenses . . . . . 275
  - host
    - Configuration Conversion Wizard. . . . . 77
- ## I
- ICON. See Interaction Concentrator
  - ICS, Internet Contact Solution . . . . . 1203
  - Informix
    - script for Configuration Database . . . . . 84
    - upgrade script for Log Database . . . . . 121
  - Installing

- Microsoft Data Access (MDAC) . . . . . 700
  - Microsoft Jet 4.0 . . . . . 700
  - Microsoft ODBC Data Source . . . . . 700
  - Microsoft ODBC drivers . . . . . 700
  - installing
    - Message Server . . . . . 134
  - Interaction Concentrator
    - attached data configuration file . 736, 740, 741, 753
    - compatibility with IDB . . . . . 707
    - component changes . . . . . 711
    - custom dispatchers . . . . . 740
    - customizing attached data processing 739, 753
    - direct migration . . . . . 709
    - functionality changed in 7.6 . . . . . 715
    - ICON Server changes in 7.6 . . . . . 714
    - ICON Server changes in 8.0 . . . . . 712
    - IDB component changes in 7.6 . . . . . 717
    - IDB component changes in 8.0 . . . . . 714
    - IDB schema changes . . . . . 726, 727
    - IDB schema relationships . . . . . 727
    - IDB scripts . . . . . 737, 743
    - installation directory . . . . . 736
    - interoperability . . . . . 708
      - See also compatibility with IDB
    - licensing requirements . . . . . 706
    - merge procedure, stopping . . . 709, 737, 743
    - merge stored procedures . . . . . 715, 730
    - migrating to 7.x . . . . . 741
    - migrating to 8.0 . . . . . 736
    - migration order . . . . . 707
    - multi-site migration . . . . . 707, 740, 753
    - multi-tenant migration . . . . . 707
    - new functionality in 7.6 . . . . . 715
    - new functionality in 8.0 . . . . . 712
    - no direct migration from 7.2 to 8.0. . . . . 709
    - order of migration . . . . . 707
    - OS and RDBMS upgrades . . . . . 705
    - persistent queue file . . . . . 709, 737, 742
    - post-IDB migration steps . . . . . 740, 753-754
    - preliminary migration procedures 705, 735, 741
    - purge indexes . . . . . 732
    - purge stored procedures . . . . . 728, 729
    - reference materials . . . . . 706
    - retrieving IDB schema version . . . 739, 743
    - stored procedures . . . . . 709, 737, 743
    - stored procedures added . . . . . 729
    - stored procedures changes . . . . 728, 729, 730
    - verifying migration . . . . . 740, 753
  - Interaction Routing Designer
    - upgrading . . . . . 618
  - Interaction SDK . . . . . 1203
  - Internet Contact Solution . . . . . 1203
  - IS Data Sourcer . . . . . 218, 230
  - IVR Interface Option . . . . . 503
    - Additional Information about Migration . . 512
  - Application Compatibility . . . . . 509
  - Architecture Changes . . . . . 507
  - Changes in 7.x . . . . . 513
  - Component Changes . . . . . 511
  - Component Compatibility . . . . . 506
  - Configuration Changes from NTS GenSpec to IVR Server . . . . . 531
  - Driver Changes 6.5 to 7.0. . . . . 520
  - Driver Changes 7.0 to 7.1. . . . . 516
  - Driver Changes 7.1 to 7.2. . . . . 516
  - Driver Changes 7.2 to 7.5. . . . . 516
  - Driver Changes 7.5 to 8.0. . . . . 515
  - Introduction to Migration . . . . . 505
  - Message Specification Migration to IVR XML . . 533
  - Migrating from Network T-Server for XML-Based GenSpec to IVR Server . . . . . 529
  - Migration Procedures . . . . . 523
  - Required Message Specification Changes for IVR XML . . . . . 534
  - Server Changes 6.5 to 7.0 . . . . . 514
  - Server Changes 7.0 to 7.1 . . . . . 514
  - Server Changes 7.1 to 7.2 . . . . . 514
  - Server Changes 7.2 to 7.5 . . . . . 514
  - Server Changes 7.5 to 8.0 . . . . . 514
  - Upgrading Driver from 6.5 to 7.x . . . . . 527
  - Upgrading Driver from 7.0 to 7.x . . . . . 525
  - Upgrading Server from 6.5 to 7.x . . . . . 524
  - Upgrading Server from 7.0 to 7.x . . . . . 523
  - IVR Option
    - Preliminary Migration Procedures . . . . . 505
- ## J
- Java Runtime Environment . . . . . 187
- ## K
- Keep-Alive Protocol . . . . . 65
  - KPL . . . . . 65
- ## L
- layout templates
    - affected by the upgrade. . . . . 220, 233
    - location . . . . . 228
  - license control architecture components
    - application program . . . . . 43
    - FLEXIm Tools . . . . . 43
    - Genesys vendor daemon . . . . . 42
    - license file. . . . . 42
    - License Manager daemon . . . . . 42
  - license control configuration
    - multiple, independent servers. . . . . 45

single server . . . . .	44
three-server redundant . . . . .	45
license control configurations	
single server . . . . .	44
licensing	
CTI-Less T-Server . . . . .	878
licensing control architecture components	
License Manager daemon . . . . .	42
licensing migration	
license control architecture . . . . .	41
license control configurations . . . . .	43, 44
licensing control architecture components . . . . .	42
upgrading licensing system . . . . .	45, 47
upgrading licensing system with multiple vendors . . . . .	53
location	
of report templates . . . . .	188
Log Database	
database types . . . . .	120
upgrading . . . . .	120
log options . . . . .	677
unified . . . . .	99
log section . . . . .	677
login procedure . . . . .	1189

## M

MDAC	
See Microsoft Data Access	
Message Server	
installing . . . . .	134
Messages	
Statistics API changes . . . . .	172
methods for upgrading licensing system	
replacing existing license server . . . . .	50
running two versions of license server . . . . .	49
upgrading three-server redundancy . . . . .	52
Microsoft Data Access (MDAC)	
installing . . . . .	700
Microsoft Jet	
installing . . . . .	700
Microsoft ODBC	
installing drivers . . . . .	700
required Oracle version . . . . .	701
selecting data source . . . . .	700
Microsoft ODBC Data Source	
installing . . . . .	700
Microsoft SQL	
script for Configuration Database . . . . .	84
upgrade script for Log Database . . . . .	121
Migrating	
GIS . . . . .	165, 166
the Statistics API . . . . .	165, 166
migrating	
VTO 5.1 to VTO 6.5 . . . . .	655
VTO 6.5 . . . . .	651

Migrating GVP	
EE when previously installed . . . . .	1012
Migration	
basic approaches . . . . .	38
definition . . . . .	35
environment compatibility . . . . .	39
new features 7.6 . . . . .	39
order . . . . .	36
preliminary procedures . . . . .	1129
preparing for . . . . .	37
recommended approach . . . . .	39
reference materials . . . . .	1130
rollback procedures . . . . .	39
three approaches . . . . .	38
training . . . . .	38
migration	
Configuration Database . . . . .	67
Framework . . . . .	61
Framework components . . . . .	115
Migration and Upgrade Order . . . . .	1130
Migration from VTO 5.1 to 6.5 . . . . .	655
Migration overview . . . . .	33
Migration Procedures . . . . .	1167
migration process . . . . .	61
first stage . . . . .	61
rollback . . . . .	62
second stage . . . . .	62
Multi-Channel Routing	
Changes in 7.1 . . . . .	897
Component Changes for 7.1 . . . . .	898
Configuration Options for 7.1 . . . . .	899
Interoperability Among MCR Components . . . . .	884
Migration Order . . . . .	883
Multi-Site and Multi-Tenant Migration . . . . .	884
Preliminary Migration Procedures . . . . .	883
Multimedia . . . . .	1203

## N

N_CANCEL metric . . . . .	233
N_DISTRIB_IN_TR metric . . . . .	220, 233
Network SIP Server	
configuration options changes . . . . .	501
new features	
CC Analyzer 5.1.6 . . . . .	198
CC Analyzer 6.0 . . . . .	196
CC Analyzer 6.1 . . . . .	195, 199
NoTEventRingingTimeoutSec . . . . .	677
NotMonitored status . . . . .	226

## O

object	
VT Server Application . . . . .	676
ODBC	



See Microsoft ODBC

option  
  configuration . . . . . 676  
  VoiceDir . . . . . 677

Options  
  Statistics API changes . . . . . 172

options  
  public\_network\_access\_code . . . . . 265

Options tab . . . . . 226

Oracle  
  script for Configuration Database . . . . . 84  
  upgrade script for Log Database . . . . . 121

Outbound Contact . . . . . 237, 503  
  changes in calling lists and formats . . . . . 274  
  changes in components . . . . . 248  
  changes in configuration options . . . . . 254  
  changes in data keys . . . . . 271  
  changes in fields and field values . . . . . 272  
  changes in licensing . . . . . 274  
  changes in primary key . . . . . 270  
  component changes . . . . . 248  
  interoperability among components . . . . . 239  
  interoperability among components . . . . . 239  
  migration from 6.5.2 to 7.0 . . . . . 290  
  migration from 7.0 to 7.1 . . . . . 290  
  migration from 7.1 to 7.2 . . . . . 286  
  migration from 7.2 to 7.5 . . . . . 282  
  migration of 6.5.100.00-6.5.100.26 to 7.0 . . . . . 295  
  migration of 6.5.100.27-6.5.100.30 to 7.0 . . . . . 292  
  migration order . . . . . 243  
  migration and upgrade order . . . . . 243  
  multi-site/single site and multi-tenant migration . . . . . 242  
  migration to 7.6 . . . . . 277, 280  
  preliminary migration procedures . . . . . 242  
  database and operating system upgrade . . . . . 242  
  database operating system upgrade . . . . . 623

Overview of Possible Configurations . . . . . 44

## P

password  
  Configuration Conversion Wizard . . . . . 78

passwords  
  for new tenant accounts . . . . . 191

port  
  Configuration Conversion Wizard . . . . . 77, 167

Preface . . . . . 27

prerequisites . . . . . 227

public\_network\_access\_code . . . . . 265

## Q

Queues . . . . . 1149

## R

recommendations . . . . . 224

RecoveryTransferDestination . . . . . 676

Release . . . . . 676

Releasing Held Calls . . . . . 1131

report layouts . . . . . 223

report templates  
  adjusting the Service Factor formula . . . . . 223

Reporting  
  High Availability . . . . . 213

Reporting Migration . . . . . 179  
  Changes in Release Content . . . . . 193  
  Configuration and Installation Issues . . . . . 186  
  Configuration Options and Runtime  
  Parameters . . . . . 199  
  Considerations . . . . . 182  
  Framework Issues . . . . . 191  
  Implementation Considerations . . . . . 183  
  Interoperability Among Framework and Reporting Components . . . . . 192  
  Migration Procedures . . . . . 211  
  Preliminary Procedures . . . . . 181  
  Report Issues . . . . . 191  
  Reporting Service Pack 6.5 . . . . . 217  
  SP 6.5  
  Restoring from Backup . . . . . 233  
  Running the Upgrade . . . . . 229  
  Stat Type Listing . . . . . 233  
  SP 6.5 Analyzing Definitions . . . . . 224  
  SP 6.5 Considerations, Recommendations 219  
  SP 6.5 Deployment Planning . . . . . 227  
  Template Issues . . . . . 188

Reporting Service Pack  
  affect on CC Pulse . . . . . 220, 233  
  affect on report layouts . . . . . 223  
  conditions for running . . . . . 218, 219  
  purpose . . . . . 218

Reporting Service Pack 6.5 . . . . . 217

requirements . . . . . 227

restriction\_time  
  GIS application option . . . . . 167

Ring . . . . . 676

rollback  
  CTI-Less T-Server . . . . . 877

rollback instructions  
  Universal Routing Server . . . . . 618

rollback procedures during migration . . . . . 39

Routing Strategies  
  changes . . . . . 1133  
  use public format . . . . . 1133

**S**

- SCE database . . . . . 67
- ScopeStatEvents
  - GIS application option . . . . . 167
- script
  - VTO 5.1 . . . . . 656
- selecting
  - Data Sourcing applications for upgrade . . . 230
  - layout templates . . . . . 231
- Service Factor metric
  - 6.1 definition . . . . . 220
  - 6.5 definition . . . . . 220
  - in Brio report templates . . . . . 223
- Session API
  - Genesys Framework SDK . . . . . 172
  - login/logout . . . . . 172
- sessionTimeout
  - GIS application option . . . . . 167
- setup.exe
  - VT Manager . . . . . 677
  - VT Server . . . . . 677
- SIP Server
  - configuration options changes . . . . . 492
- SM (VoIP Stream Manager) . . . . . 441, 462
  - application type . . . . . 462
- SNMP . . . . . 126
- SNMP Option . . . . . 125
- Software Requirements
  - Microsoft ODBC for Oracle . . . . . 701
- sql\_scripts folder . . . . . 84
- staging
  - the upgrade . . . . . 219
- Stat Server
  - rollback instructions . . . . . 157
  - upgrade . . . . . 123
- stat types
  - comparing definitions . . . . . 224
  - shared with CC Pulse . . . . . 233
  - synchronizing definitions . . . . . 233
- Statistics API
  - customizing application options . . . . . 166
  - migration overview . . . . . 160
  - migration procedure . . . . . 165, 166
  - option changes . . . . . 167
  - system requirements . . . . . 162, 163
  - updates to methods . . . . . 172
  - viewing configuration objects . . . . . 173
- Steam Manager
  - configuration options changes . . . . . 497
- stopping
  - data collection . . . . . 219
  - the upgrade . . . . . 230
- Stream Manager
  - see SM
- supported operating systems
  - CC Analyzer 6.0 . . . . . 196
  - CC Analyzer 6.1 . . . . . 195
  - CC Analyzer 7.2 . . . . . 194
  - supported platforms . . . . . 227
  - supported RDBMSs
    - CC Analyzer 6.0 . . . . . 196
    - CC Analyzer 6.1 . . . . . 196
    - CC Analyzer 7.2 . . . . . 194
  - switch-specific option changes
    - HA Proxy for Avaya DEFINITY ECS (MV) 338
    - HA Proxy for Nortel Communication Server 2000/21000 . . . . . 386
    - HA Proxy for Philips Sopho iS3000 . . . . . 388
    - Network T-Server for AT&T . . . . . 411
    - Network T-Server for Concert . . . . . 411
    - Network T-Server for CRSP . . . . . 415
    - Network T-Server for DTAG . . . . . 416
    - Network T-Server for GenSpec . . . . . 417
    - Network T-Server for ISCP . . . . . 425
    - Network T-Server for NGSN . . . . . 426
    - Network T-Server for OPSI . . . . . 427
    - Network T-Server for SR3511 . . . . . 427
    - T-Server for Alcatel A4200/OXO . . . . . 320
    - T-Server for Alcatel A4400/OXE . . . . . 323
    - T-Server for Aspect ACD . . . . . 330
    - T-Server for Avaya Communication Manager . . . . . 333
    - T-Server for Avaya INDeX . . . . . 338
    - T-Server for Avaya TSAPI . . . . . 343
    - T-Server for Cisco Unified Communications Manager . . . . . 344
    - T-Server for DataVoice Dharma . . . . . 347
    - T-Server for Digitro AXS/20 . . . . . 349
    - T-Server for EADS Intecom M6880 . . . . . 361
    - T-Server for Ericsson MD110 . . . . . 351
    - T-Server for Fugitsu 9600 . . . . . 359
    - T-Server for Huawei C&C08 . . . . . 367
    - T-Server for Meridian 1 . . . . . 368
    - T-Server for Mitel SX-2000/MN-3300 . . . . . 369
    - T-Server for NEC NEAX/APEX . . . . . 374
    - T-Server for Nortel Communication Server 1000 with SCCS/MLS . . . . . 376
    - T-Server for Nortel Communication Server 2000/2100 . . . . . 380
    - T-Server for Philips Sopho iS3000 . . . . . 386
    - T-Server for Rockwell Spectrum . . . . . 389
    - T-Server for Siemens Hicom 300/HiPath 4000 CSTA 1 . . . . . 391
    - T-Server for Siemens HiPath 3000 CSTA III . . . . . 400
    - T-Server for Siemens HiPath 4000 CSTA III . . . . . 401
    - T-Server for Siemens HiPath DX . . . . . 397
    - T-Server for Symposium Call Center Server . . . . . 406
    - T-Server for Tadiran Coral . . . . . 406



T-Server for Teltronics 20-20 . . . . . 408  
 T-Server for Tenovis Integral 33/55 . . . . . 409  
 Sybase  
   script for Configuration Database . . . . . 84  
   upgrade script for Log Database . . . . . 121  
 synchronizing  
   stat type definitions . . . . . 233  
 Sys\*.VOX files . . . . . 677  
 System Requirements  
   for the Statistics API . . . . . 162, 163  
   GIS . . . . . 162, 163

## T

Total\_Calls\_Answered\_In\_Threshold stat type . . . . . 220  
 Total\_Calls\_Distributed\_In\_Threshold stat type . . . . . 220  
 Total\_Calls\_Outbound stat type . . . . . 225, 226  
 Total\_Login\_Time stat type . . . . . 226  
 TotalAdjustedNumber statistical category . . . . . 221, 225  
 TotalAdjustedTime statistical category . . . . . 221  
 TotalNumber statistical category . . . . . 225  
 T-Servers  
   configuration options common to all . . . . . 307  
   obsolete configuration options . . . . . 330  
   specific configuration options . . . . . 318  
   Timeout Value Format . . . . . 317  
 typographical styles . . . . . 29

## U

uninstalling  
   the service pack . . . . . 229  
 Universal Routing . . . . . 557  
   component changes for 7.0 . . . . . 592  
   configuration option changes . . . . . 593  
   interoperability among components . . . . . 563  
   IRD function changes . . . . . 600  
   migration order . . . . . 561, 562  
   preliminary migration procedures . . . . . 559  
   single-site/multi-site and multi-tenant migration . . . . . 561  
 Universal Routing Server  
   rollback instructions . . . . . 618  
 unpacking  
   the archive . . . . . 228  
 upgrade  
   CTI-Less T-Server . . . . . 876  
 upgrading  
   CC Analyzer components . . . . . 219  
   component, VTO . . . . . 649, 651, 675  
   Interaction Routing Designer . . . . . 618  
   metric definitions in stages . . . . . 219

options . . . . . 230  
 stat types . . . . . 219  
 the Service Factor metric . . . . . 219  
 VT Server . . . . . 677  
 Upgrading Individual VTO Components . . . . . 674  
 upgrading licensing system  
   methods . . . . . 49  
 upgrading licensing system with multiple vendors  
   multiple, independent servers . . . . . 55  
   single-server configuration . . . . . 53  
 username  
   Configuration Conversion Wizard . . . . . 78  
 using .XML files  
   to compare stat type definitions . . . . . 226  
 using DMA  
   to compare stat type definitions . . . . . 225  
   to synchronize stat types . . . . . 233  
 using the Configuration Manager  
   to compare stat type definitions . . . . . 226

## V

Voice Callback . . . . . 643  
   component changes . . . . . 632  
   configuration option changes . . . . . 632, 633  
   migration order 7.0 . . . . . 625  
   migration procedures 6.5 to 7.0 . . . . . 643  
   preliminary procedures . . . . . 623  
 Voice Treatment Manager . . . . . 651  
 Voice Treatment Option 5.1 . . . . . 649, 651  
 Voice Treatment Option 6.5 . . . . . 649, 651  
 Voice Treatment Server . . . . . 651  
 VoIP Stream Manager  
   see SM  
 VT Manager  
   new version . . . . . 677  
   older version . . . . . 677  
 VT Server  
   new version . . . . . 677  
   older version . . . . . 677  
   previous version . . . . . 677  
 VTO 5.1 . . . . . 649, 651  
 VTO 6.5 . . . . . 649, 651, 655

## W

WaitForEstablishedTimeout . . . . . 676  
 Weighted Round Robin mode . . . . . 131  
 Wizard  
   VTO Configuration . . . . . 652, 675  
 Workforce Management . . . . . 679  
 WWR mode . . . . . 131

